

# Gaskets for Heat Exchangers

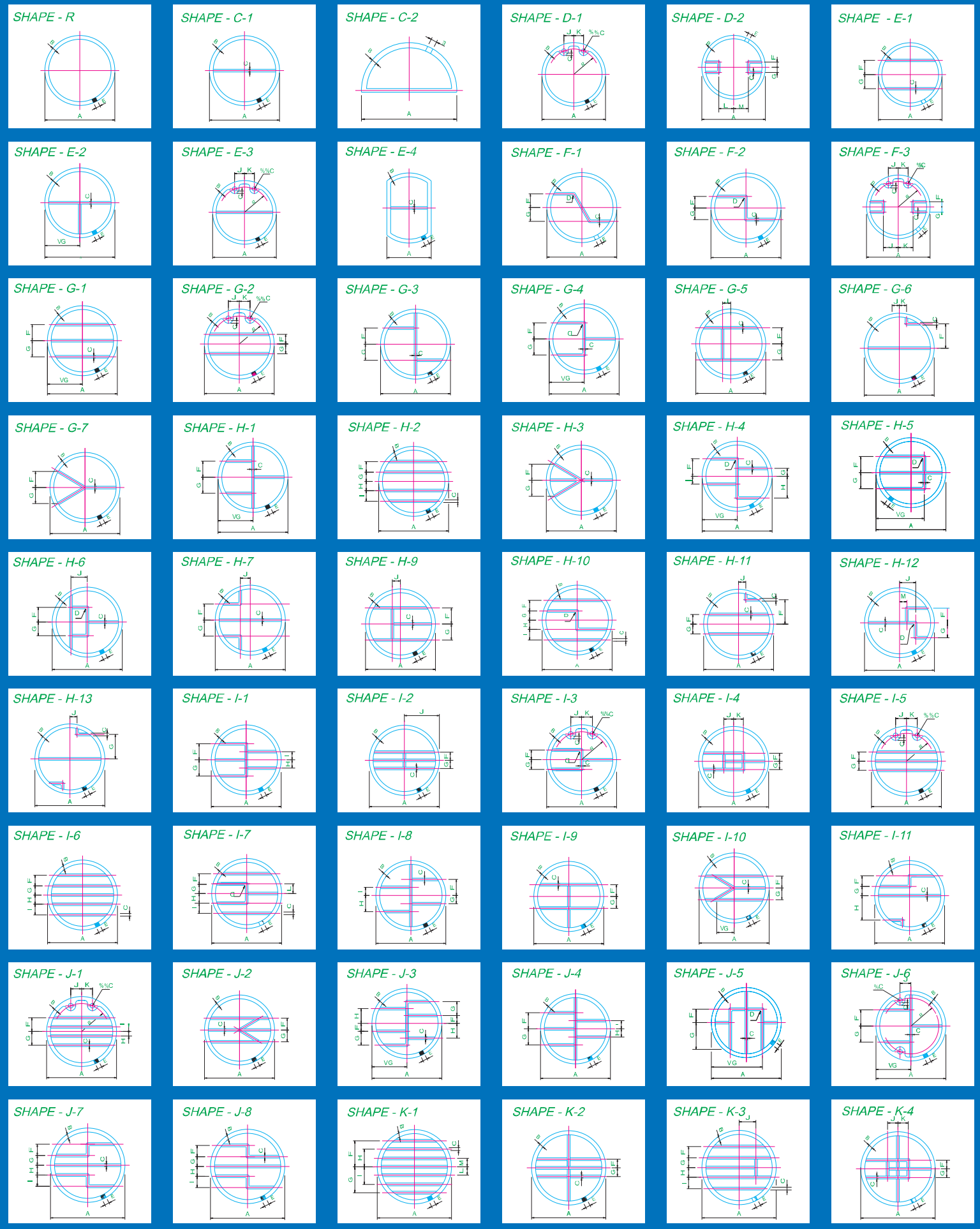

### Other Teadit Products:

- Filaments
- Packings
- Compressed Gasket Sheets
- Expanded PTFE Products
- Dental Floss
- Technical Yarns and Fabrics
- Expansion Joints
- Metallic Gaskets
- Tealon PTFE Gasket Sheets

The Teadit Group serves its customers in North America from its large distribution and fabrication center located in Houston, Texas. In business for almost fifty years, the TEADIT GROUP has the most complete line of compression packings in the world, producing most of its own filaments and yarns. It is also a world leader in the development and production of industrial gasket sheet and spiral wound gaskets.

Teadit N.A., Inc. provides complete marketing and technical support to its distributors. The Houston inventory is substantial, carrying all products needed in the fluid sealing industry.

The Teadit Group is comprised of TOTAL QUALITY MANAGEMENT companies and is committed to 100% customer satisfaction through innovative product development, cost effective manufacturing, ample investment in finished goods inventory and efficient customer service... all performed by empowered employees, committed to continuous

Feb/09

# Metallic Gaskets

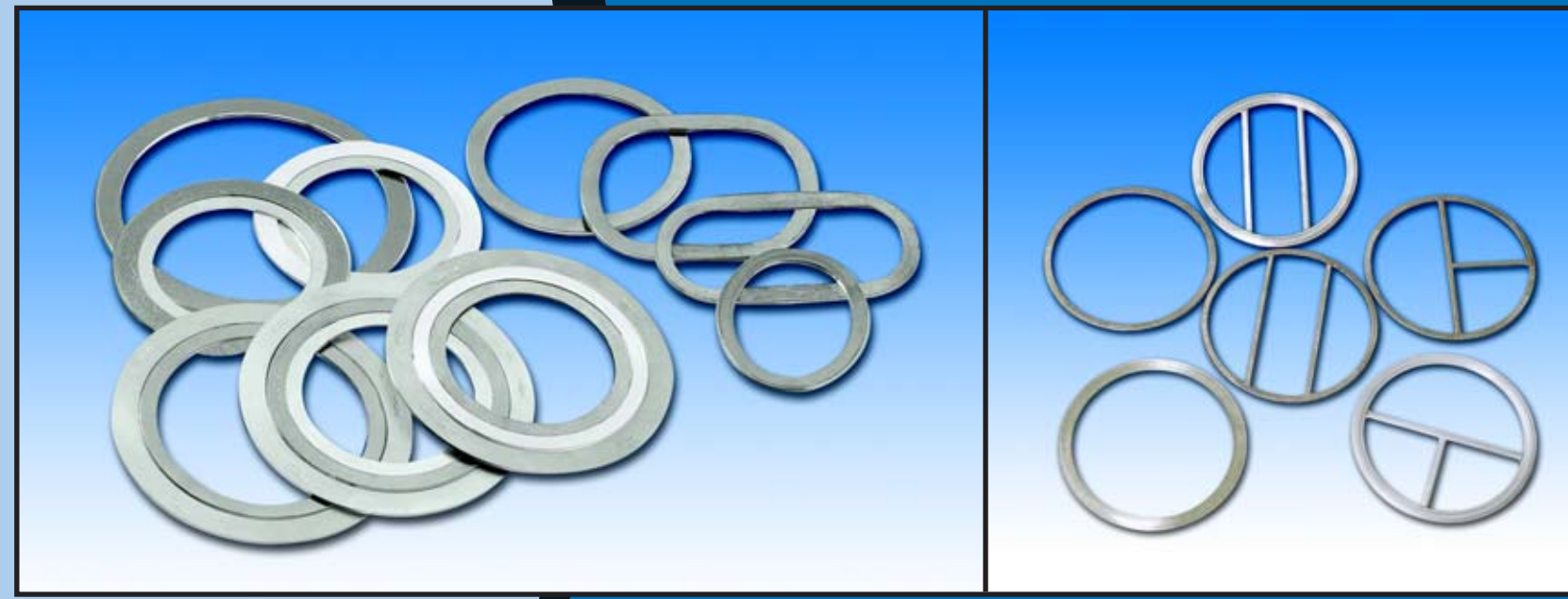

Houston Texas USA

**GOODYEAR**  
RUBBER PRODUCTS, INC.

727-342-5088

You can also email us at [GRP@goodyearrubberproducts.com](mailto:GRP@goodyearrubberproducts.com)



## Spiral wound gaskets Types and Profiles

### Utilized for Extreme Conditions

Gaskets per ASME B16.20 have the winding with an external guide on the centering ring. This solid metallic ring centralizes the gasket on the flange surface, limits the compression and reinforces the gasket.

Several countries developed dimensional standards for this style of gasket. On March 30th, 1993 the American Society of Mechanical Engineers (ASME) and the American National Standards Institute (ANSI) issued a new edition of the ASME B16.20. This edition includes spiral wound gaskets specifications and dimensions previously covered by the API 601 which will no longer be published by the American Petroleum Institute (API). ASME B16.20 was most recently updated in 2007, adding new inner ring requirements and metrication of units.

The ASME B16.20 (API 601) standard is one of the most used, worldwide. Gaskets manufactured following the recommendations of the ASME B16.20 are produced in large quantities. They are low priced compared with other gaskets of equivalent performance. When specifying a metallic gasket they should be the first design option. The use of another type of metal gasket should only be recommended if required by the specific application conditions.

The ASME B16.20 gaskets were designed for use in ASME B16.5 flanges or ASME 16.47 (API 605 and MSS SP-44). Therefore, when ordering a spiral wound gasket for these flanges, dimensions are not necessary. It is enough to inform materials for the metallic strip and filler, which should be compatible with the fluid to be sealed, the outer and inner ring metal, the nominal diameter and the pressure class of the flange. In charts below, are the dimensions for ASME B16.20 gaskets. The outrings are color coded on the outer with a solid color to indicate the metallic winding strip and stripes indicating the filler.

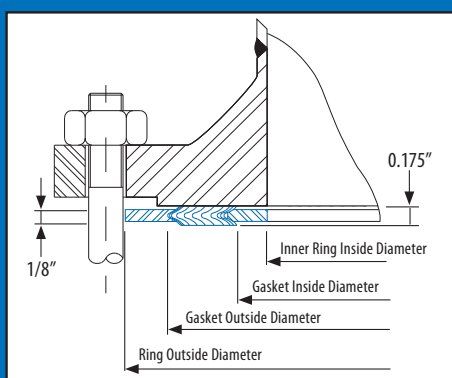

Metalic Strip		Filler Color Coding	
Material	Color	Material	Color
AISI 304	Yellow		
AISI 316	Green	PTFE	White
AISI 347	Blue	Flexible Graphite	Gray
AISI 321	Turquoise	Mica-Graphite	Pink
Monel	Orange		
Nickel	Red		
Carbon Steel	Silver		
Inconel	Gold		

Nominal	Gasket Outside Diameter		Gasket Inside Diameter				Ring Outside Diameter				Inner Ring Inside Diameter													
	150	300	150	300	400	600	900	1500	2500	150	300	400	600	900	1500	2500	150	300	400	600	900	1500	2500	
1/2		1.25	0.75	0.75		0.75		0.75	0.75	1.88	2.13		2.13		2.50	2.75	0.56	0.56		0.56		0.56	0.81	0.81
3/4		1.56	1.00	1.00		1.00		1.00	1.00	2.25	2.63		2.63		2.75	3.00	0.81	0.81		0.81		0.81	0.81	0.81
1		1.88	1.25	1.25	use	1.25	use	1.25	1.25	2.63	2.88	use	2.88		3.13	3.38	1.06	1.06	use	1.06	use	1.06	1.06	1.06
1 1/4		2.38	1.88	1.88		1.88	1500	1.56	1.56	3.00	3.25	600	3.25	1500	3.50	4.13	1.50	1.50	600	1.50	1500	1.31	1.31	1.31
1 1/2		2.75	2.13	2.13		2.13		1.88	1.88	3.38	3.75		3.75		3.88	4.63	1.75	1.75		1.75		1.63	1.63	1.63
2		3.38	2.75	2.75	psi	2.75	psi	2.31	2.31	4.13	4.38	psi	4.38		5.63	5.75	2.19	2.19	psi	2.19	psi	2.06	2.06	2.06
2 1/2		3.88	3.25	3.25		3.25		2.75	2.75	4.88	5.13		5.13		6.50	6.63	2.62	2.62		2.62		2.50	2.50	2.50
3		4.75	4.00	4.00		4.00	3.75	3.63	3.63	5.38	5.88		5.88	6.63	6.88	7.75	3.19	3.19		3.19	3.10	3.10	3.10	3.10
4		5.88	5.00	5.00	4.75	4.75	4.63	4.63	4.63	6.88	7.13	7.00	7.63	8.13	8.25	9.25	4.19	4.19	4.04	4.04	4.04	3.85	3.85	3.85
5		7.00	6.13	6.13	5.81	5.81	5.81	5.63	5.63	7.75	8.50	8.38	9.50	9.75	10.00	11.00	5.19	5.19	5.05	5.05	5.05	4.90	4.90	4.90
6		8.25	7.19	7.19	6.88	6.88	6.88	6.75	6.75	8.75	9.88	9.75	10.50	11.38	11.13	12.50	6.19	6.19	6.10	6.10	6.10	5.80	5.80	5.80
8		10.38	9.19	9.19	8.88	8.88	8.88	8.75	8.50	11.00	12.13	12.00	12.63	14.13	13.88	15.25	8.50	8.50	8.10	8.10	8.10	7.75	7.75	7.75
10		12.50	11.31	11.31	10.81	10.81	10.88	10.50	10.63	13.38	14.25	14.13	15.75	17.13	17.13	18.75	10.56	10.56	10.05	10.05	9.69	9.69	9.69	9.69
12		14.75	13.38	13.38	12.88	12.88	12.75	12.75	12.50	16.13	16.63	16.50	18.00	19.63	20.50	21.63	12.50	12.50	12.10	12.10	11.50	11.50	11.50	11.50
14		16.00	15.75	14.63	14.25	14.25	14.00	14.25		17.75	19.13	19.00	19.38	20.50	22.75		13.75	13.75	13.50	13.50	12.63	12.63	12.63	12.63
16		18.25	18.00	16.63	16.63	16.25	16.25	16.25	16.00	20.25	21.25	21.13	22.25	22.63	25.25		15.75	15.75	15.35	15.35	14.75	14.50	14.50	14.50
18		20.75	20.50	18.69	18.69	18.50	18.25	18.25		21.63	23.50	23.38	24.13	25.13	27.75		17.69	17.69	17.25	17.25	16.75	16.75	16.75	16.75
20		22.75	22.50	20.69	20.69	20.50	20.25	20.25		23.88	25.75	25.50	26.88	27.50	29.75		19.69	19.69	19.25	19.25	19.00	18.75	18.75	18.75
24		27.00	26.75	24.75	24.75	24.75	24.25	24.25		28.25	30.50	30.25	31.13	33.00	35.50		23.75	23.75	23.25	23.25	23.25	22.75	22.75	22.75

Dimensions in inches.

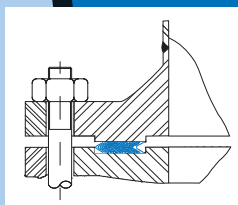

### 911

This is the simplest style of spiral wound gasket, consisting of a circular winding without guide or inner rings. Spiral wound gaskets Style 911 are mainly used in tongue and groove or male and female flanges. They are also used in equipment with space and weight limitations. Special flange machining may be necessary (contact Teadit Technical Dept).

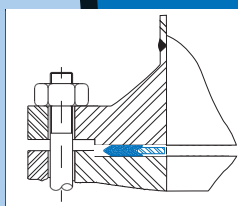

### 911M

A style 911-M gasket is a sealing winding with an inner ring. The purpose of this ring is to fill out the space between the flanges, avoiding turbulence in the flow of the fluid or as a protection against corrosion or erosion. It is also used as a compression limit.

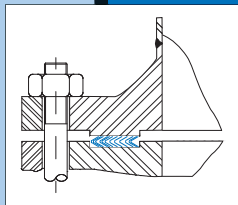

### 911T

Double jacketed bars are welded into the winding. They are used in shell and tube heat exchangers with several passes. The bars are manufactured in the same material and are welded to the winding. The thickness of the bar is normally a little less than the winding to reduce the seating force of the gasket. Style 911-T has a better sealability than conventional heat exchanger double-jacketed gaskets. However a specially machined groove with an appropriate compression stop is needed for 911-T.

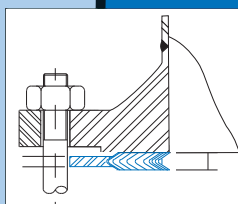

### 913

The construction of this gasket is circular metal windings with an outer guide ring. The sealing element is made of the specified metal and soft sealing material. The standard pipe size gaskets are made to the ASME B16.20 (see also style 913M). These gaskets are used in a very wide variety of applications.

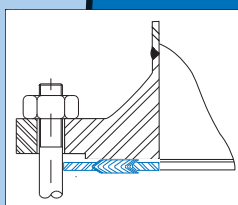

### 913M

The 913M is the standard spiral wound gasket with an inner ring. The purpose of this ring is to fill out the space between the flanges, avoiding turbulence in the flow of the fluid or as a protection against corrosion or erosion. It is also used as a compression limit. Gaskets with PTFE filler have a tendency to inward buckle thus the use of an inner ring is required by ASME B16.20. Inner rings are also required with ASME standard spiral wound gaskets with flexible graphite fillers unless the purchaser specifies otherwise. Some sizes and pressure class require inner rings regardless of filler material.

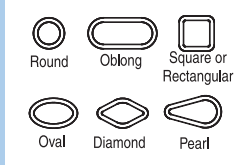

### 914

Style 914 spiral wound gaskets are windings in non-circular forms like oval, rectangular and square with rounded corners, diamond, oblong or pear shaped. Style 914 gaskets are used in boiler handholes and manholes, equipment, engine head-gaskets and exhaust systems. Inner rings should also be used for many of these applications.

## Gaskets for Heat Exchangers

There are several types of Heat Exchangers, some of them so incorporated in our life style that we hardly notice them, like car radiators or home heating units. All of them transfer heat from one fluid to the other, cooling (radiator) or heating (home heating), according to the process needs.

In industry, there are several types of Heat Exchangers, some have specific names like radiators, boilers, chillers, etc. However, when we refer to a Heat Exchanger generically, we may be referring to any of them. However, the term Heat Exchanger, in most process industries is referred to as the "Shell and Tube Heat Exchanger". As the name implies, it is equipment that has a "shell" and a bundle of "tubes". One of the fluids flows inside the shell and outside the tubes and the

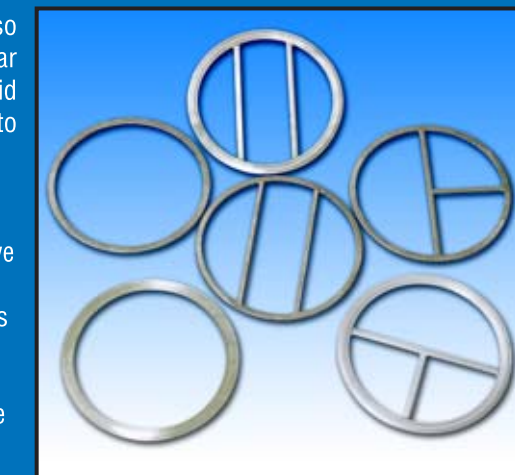

The great majority of the Shell and Tube Heat Exchangers are manufactured following the recommendations of the "Standards of the Tubular Exchanger Manufacturers Association TEMA", which sets the guidelines for design, construction, testing, installation and maintenance of this equipment.

### Design

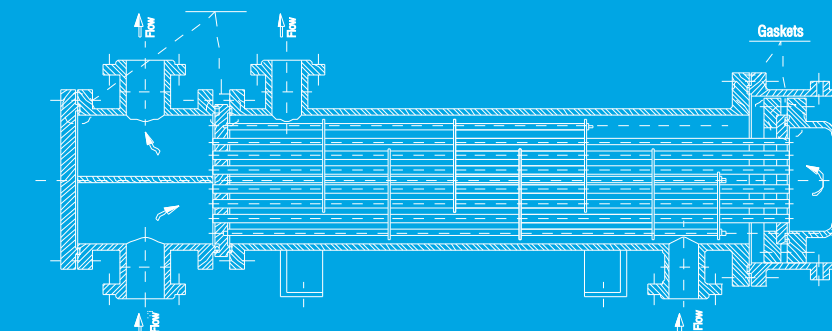

Style 927 Metalbest	Style 911 Metaflex	Style 942 Camprofile	Style 905 Metalbest	Style 923	Style 940
Double Jacket with Graphite Facing	Spiral Wound	Solid Metal with specified facing material	Corrugated metal core graphite facing material	Double Jacket	Solid Metal

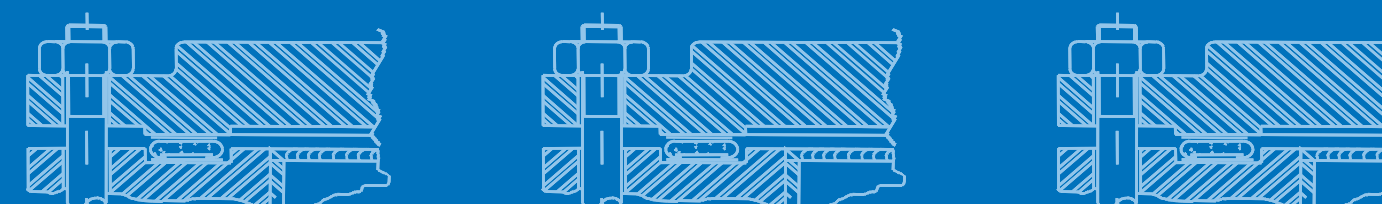

Properties and application parameters shown throughout this data sheet are typical. Your specific application should not be undertaken without independent study and evaluation for suitability. For specific application recommendations consult TEADIT. Failure to select proper sealing products could result in property damage and/or serious personal injury. Specifications are subject to change without notice; this edition cancels all previous issues.