

# SPIRAL WOUND GASKETS

*Flexitallic*<sup>®</sup>



**GOODYEAR**  
RUBBER PRODUCTS, INC.

☎ 727-342-5088

You can also email us at  
[GRP@goodyearrubberproducts.com](mailto:GRP@goodyearrubberproducts.com)

# Introduction

## FIRST AND FOREMOST

The concept of spiral wound gasket construction was originated by Flexitallic in 1912, inaugurating the beginning of a new era in safe, effective sealing. The primary purpose for this development was the increasingly severe temperatures and pressures used by U.S. refinery operators in the first half of the century.

The necessity for a gasket to have the ability to recover cannot be over emphasized. The effects of pressure and temperature fluctuations, the temperature differential across the flange face, together with bolt stress relaxation and creep, demand a gasket with adequate flexibility and recovery to maintain a seal even under these varying service conditions. The Flexitallic Spiral Wound Gasket is the precision engineered solution to such problems, meeting the most exacting conditions of both temperature and pressure in flanged joints and similar assemblies and against virtually every known corrosive and toxic media.

This publication is designed to facilitate the specification and ordering of standard Flexitallic Spiral Wound Gaskets. Dimensional data for the basic styles - Style CG, Style CGI, Style R and Style RIR are detailed on respective tables.

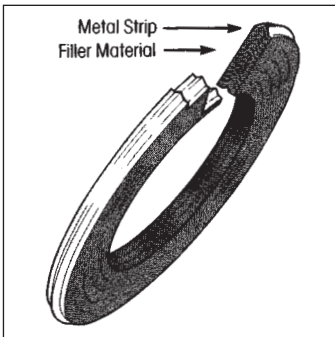

# GASKET IDENTIFICATION GUIDE RING COLOR CODING

For ease of identification, Flexitallic Spiral Wound Gaskets utilize a color coding system around the outside edge of the centering ring, thus permitting full identification of both the winding and filler materials.

## METALLIC WINDING MATERIALS

The metallic winding material is designated by a solid color identification around the outside edge of the centering ring.

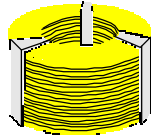

304SS  
Yellow

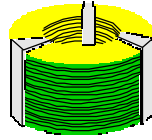

316LSS  
Green

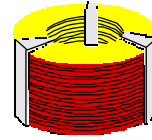

317L  
Maroon

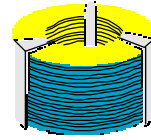

321SS  
Turquoise

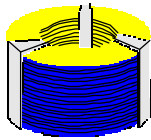

347SS  
Blue

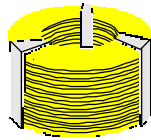

310SS  
No color

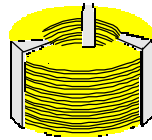

304LSS  
No color

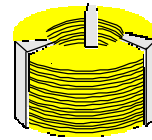

309SS  
No color

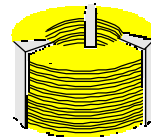

430SS  
No color

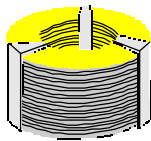

Alloy 20  
Black

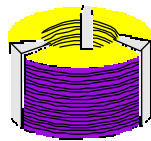

Titanium®  
Purple

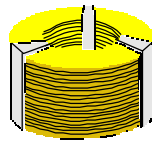

Inconel® 600/625  
Gold

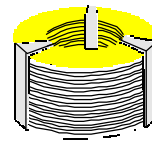

Incoloy® 800/825  
White

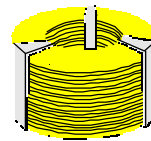

Inconel® X750  
No Color

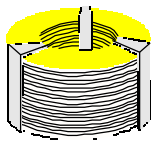

Hastelloy® C276  
Beige

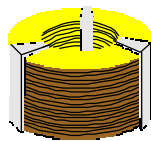

Hastelloy® B2  
Brown

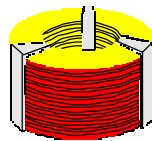

Nickel 200  
Red

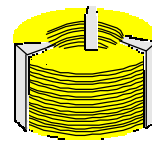

Zirconium  
No color

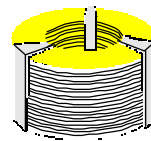

Carbon Steel  
Silver

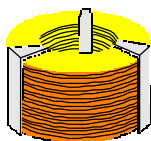

Monel®  
Orange

## NON METALLIC FILLERS

The gasket filler materials are designated by a number of stripes placed at equal intervals around the outside edge of the centering ring.

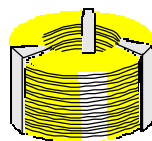

PTFE  
White Stripe

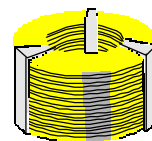

Flexicarb®  
Gray Stripe

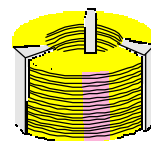

Flexite Super®  
Pink Stripe

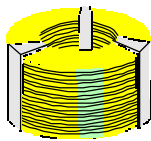

Ceramic  
Light Green Stripe

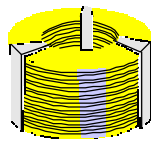

Thermiculite™  
Light Blue Stripe

# AVAILABLE GASKET MATERIALS

| METAL WINDING STRIP | FILLER MATERIAL  | GUIDE RING MATERIAL |
|---------------------|--|---------------------|
| AS STANDARD         | Flexicarb® flexible graphite   | AS STANDARD         |
| Stainless Steel 304 | Thermiculite™  | Carbon Steel        |
| type 316L           | Flexite Super®   |                     |
|                     | PTFE   |                     |
| OTHERS              | Mica   | OTHERS              |
| Stainless Steel     | Ceramic  | Stainless Steel     |
| type 304L           | Non-sintered PTFE  | type 304            |
| 309                 |  | 304L                |
| 310                 | Thermiculite, FLEXITALLIC'S new high-temperature, sealing material is comprised of chemically exfoliated and thermally exfoliated vermiculite.   | 316                 |
| 316Ti               | This revolutionary new product simulates the structure of exfoliated graphite but with one notable exception... gaskets made with Thermiculite maintain their integrity, even at extreme temperatures. | 316L                |
| 317L                | Thermiculite is thermally stable, ensuring against thermal oxidation, at temperatures in excess of 1600°F.   | 316Ti               |
| 321                 |  | 310                 |
| 347                 |  | 321                 |
| 430                 |  | 347                 |
| 17-7PH              |  | 410                 |
| ALLOY 20            |  | INCONEL® 600        |
| MONEL®              |  | 625                 |
| TITANIUM®           |  | MONEL®              |
| NICKEL® 200         |  | TITANIUM®           |
| INCONEL® 600        |  | NICKEL              |
| 625                 |  | INCOLOY® 800        |
| X-750               |  | ALLOY 20            |
| HASTELLOY® B2       |  | INCOLOY® 825        |
| C276                |  | HASTELLOY® B-2      |
| INCOLOY® 800        |  | C276                |
| 825                 |  |                     |
| DUPLEX              |  |                     |
| ZIRCONIUM®          |  |                     |
| TANTALUM®           |  |                     |
| COPPER              |  |                     |
| PHOS-BRONZE         |  |                     |
| CARBON STEEL        |  |                     |

**NOTE**  
 Selected materials should be compatible with operating temperature and chemicals.  
 If in doubt, contact Flexitallic Technical Department.

**PTFE:**  
 If PTFE is subjected to temperatures above 250°C (500°F) decomposition starts to occur slowly, increasing rapidly above 400°C (750°F). Care should be taken to avoid inhaling the resultant fumes, which may produce hazardous effects.

## IDENTIFICATION REQUIREMENTS

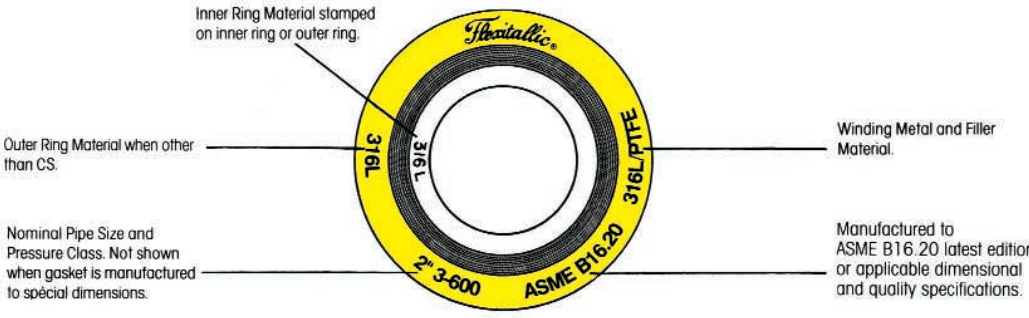

## Style CG

Utilizes an external ring which accurately centers gasket on flange face, provides additional radial strength to prevent gasket blow-out and acts as a compression stop. A general purpose gasket suitable for use with flat face and raised face flanges up to and inclusive of class 2500. Above class 600 an internal ring is recommended

## Style CGI

A Style CG gasket fitted with internal ring which gives an additional compression limiting stop and provides heat and corrosion barrier protecting gasket windings and preventing flange erosion. Suitable for use with flat face and raised face flanges and specified for high pressure/temperature service - class 900 and above or where corrosive or toxic media are present.

## Style R

Basic construction type. Inner and outer diameters are reinforced with several plies of metal without filler to give greater stability and better compression and sealing characteristics. Suitable for tongue and groove or male and female or grooved to flat face flange assemblies.

## Style RIR

Solid inner metal ring acts as a compression stop and fills the annular space between flange bore and the inside diameter of the gasket. Designed to prevent accumulation of solids, reduce turbulent flow at process turlds and minimize erosion at flange faces. Suitable for male and female pipe flanges.

## GASKET SELECTION What style of gasket should I select?

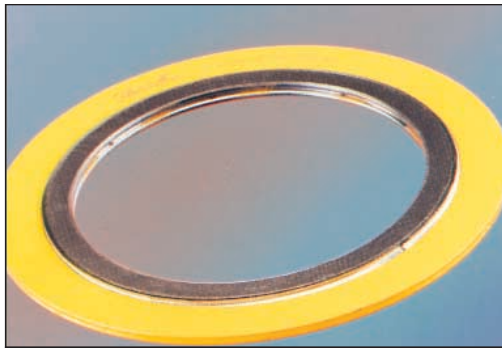

Style CG

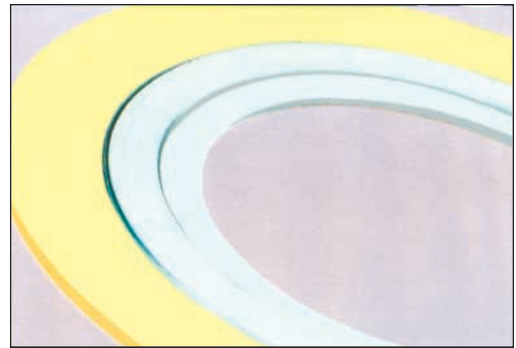

Style CGI



Style R

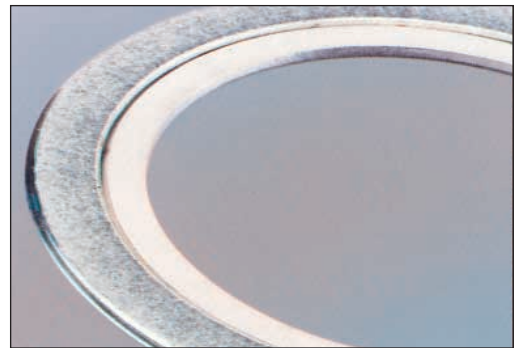

Style RIR

## SELECTION GUIDE Published as an indication of which Flexitallic Spiral wound Gasket best suits different pipe flange Configurations and service conditions.

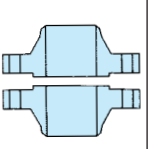
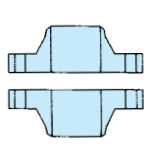
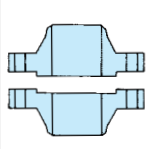
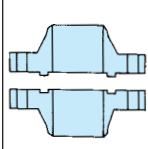
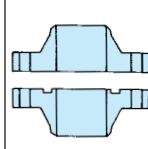
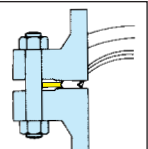
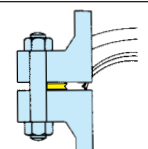
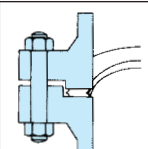
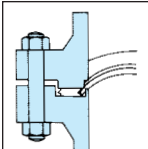
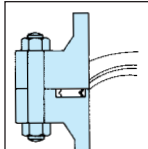
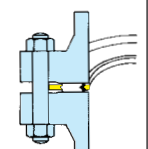
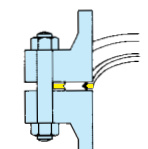
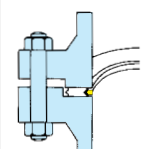
| Flange Face  |               |               |               |   |              |
|--|--|--|---|--|---|
| Recommended Gasket Style   | <br>Style CG  | <br>Style CG  | <br>Style R*  | <br>Style R*  | <br>Style R* |
| Recommended Gasket Style<br><small>For high pressure/temperature duty, also for gaskets with PTFE filler, corrosive or fluctuating pressure or temperature service conditions.</small> | <br>Style CGI | <br>Style CGI | <br>Style RIR | <p><b>*NOTE</b><br/>It is essential that Style R gaskets operate with a compression stop. Without a correctly dimensioned stop the gasket can easily be overcompressed resulting in failure. To provide a compression stop the depth of the tongue, groove or recess is controlled to provide optimum compressed gasket thickness with metal to metal contact at the flange faces (see Page 25, Table 16).</p> |   |
|  |  |  |   |  |   |

**SPECIAL GASKETS**

Gaskets of special design can be engineered and fabricated using the same basic fundamentals of Flexitallic Spiral Wound Gasket design and construction to cover a wide range of applications in installations for which there are no industry-wide standards. Special gaskets have been designed for valves, pumps, compressors, turbines, boilers, heat exchangers, etc. Consult with Flexitallic engineers as early in the design stage as possible.

**GOVERNMENT SPECIFICATIONS**

Flexitallic Spiral Wound Gaskets are available in accordance with Military Specifications MIL-G-24716, and MIL-G-15342, latest revisions. When making an inquiry, refer to the proper Government Specification number.

**DIMENSIONAL DATA - STYLE CG & CGI GASKETS**  
TO SUIT STANDARD RAISED FACE AND FLAT FACE FLANGES

\*Style CG

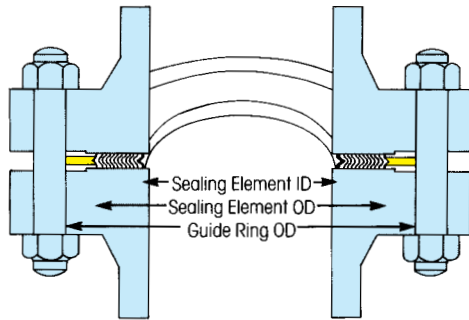

\*Style CGI

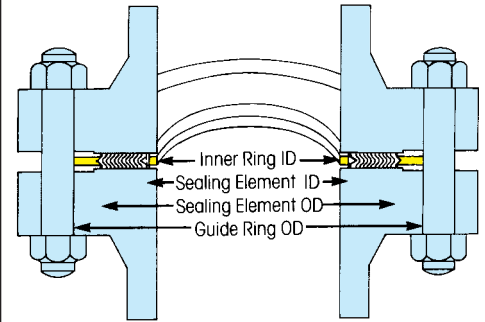

All CG and CGI Gaskets for these standard flanges are 4.5mm (0.175in) thick, fitted with 3.2mm (0.125in) thick solid metal rings. Unless otherwise stated.

Flexitallic style CG and CGI Spiral wound gaskets can be manufactured in accordance with all relevant gasket standards to suit the following flange designations.

|             |          |             |  |
|-------------|----------|-------------|--|
| ASME        | B16.5    |             |  |
| BS          | 1560     |             |  |
| BS          | 10       |             |  |
| ASME B16.47 | SERIES B | (API 605)   |  |
| ASME B16.47 | SERIES A | (MSS SP 44) |  |
| BS          | 4504     |             |  |
| DIN         | FLANGES  |             |  |

Please note that gaskets for non-standard flanges are also readily available.

**WHEN ORDERING PLEASE SPECIFY**

GASKET STYLE  
  
NOMINAL PIPE SIZE (NPS)  
  
PRESSURE RATING  
  
GASKET STANDARD  
  
WINDING MATERIALS  
  
OUTER RING MATERIAL  
  
INNER RING MATERIAL

**EXAMPLE**

FLEXITALLIC STYLE "CGI" SPIRAL WOUND  
GASKET  
  
4"  
  
CLASS 900  
  
ASME B16.20  
  
316L/FLEXICARB  
  
CARBON STEEL  
  
316L

Please select correct gasket style for your particular application. See page 6 "Gasket Selection".

# STYLE CG & CGI\* TO ASME B16.20 TO SUIT ASME B16.5 FLANGES

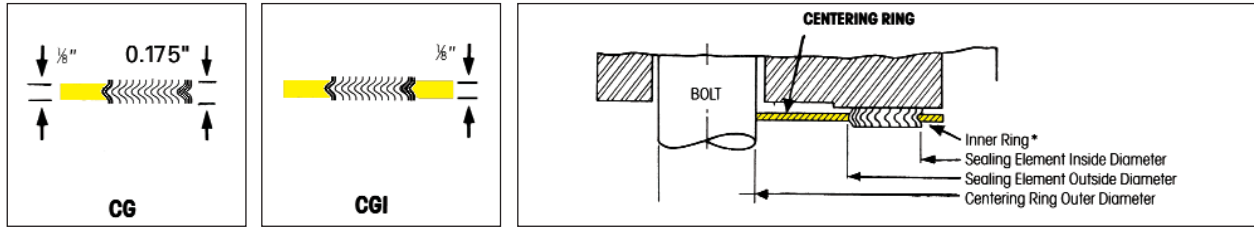

TABLE  
1

| NOM<br>PIPE<br>SIZE | OUTSIDE DIAMETER<br>OF SEALING ELEMENT |                            | INNER DIAMETER OF SEALING ELEMENT |              |              |              |              |               |               | OUTER DIAMETER OF CENTERING RING |              |              |              |              |               |               |
|---------------------|--|----------------------------|-----------------------------------|--------------|--------------|--------------|--------------|---------------|---------------|----------------------------------|--------------|--------------|--------------|--------------|---------------|---------------|
|                     | CLASS<br>150, 300<br>400, 600          | CLASS<br>900, 1500<br>2500 | CLASS<br>150                      | CLASS<br>300 | CLASS<br>400 | CLASS<br>600 | CLASS<br>900 | CLASS<br>1500 | CLASS<br>2500 | CLASS<br>150                     | CLASS<br>300 | CLASS<br>400 | CLASS<br>600 | CLASS<br>900 | CLASS<br>1500 | CLASS<br>2500 |
| 1/4                 | 7/8                                    | -                          | 1/2                               | 1/2          | 1/2          | 1/2          | -            | -             | -             | 1 3/4                            | 1 3/4        | 1 3/4        | 1 3/4        | -            | -             | -             |
| 1/2                 | 1 1/4                                  | 1 1/4                      | 3/4                               | 3/4          | 3/4          | 3/4          | 3/4          | 3/4           | 3/4           | 1 7/8                            | 2 1/8        | 2 1/8        | 2 1/8        | 2 1/2        | 2 1/2         | 2 3/4         |
| 3/4                 | 1 1/16                                 | 1 1/16                     | 1                                 | 1            | 1            | 1            | 1            | 1             | 1             | 2 1/4                            | 2 5/8        | 2 5/8        | 2 5/8        | 2 3/4        | 2 3/4         | 3             |
| 1                   | 1 7/8                                  | 1 7/8                      | 1 1/4                             | 1 1/4        | 1 1/4        | 1 1/4        | 1 1/4        | 1 1/4         | 1 1/4         | 2 5/8                            | 2 7/8        | 2 7/8        | 2 7/8        | 3 1/8        | 3 1/8         | 3 3/8         |
| 1 1/4               | 2 3/8                                  | 2 3/8                      | 1 7/8                             | 1 7/8        | 1 7/8        | 1 7/8        | 1 9/16       | 1 9/16        | 1 9/16        | 3                                | 3 1/4        | 3 1/4        | 3 1/4        | 3 1/2        | 3 1/2         | 4 1/8         |
| 1 1/2               | 2 3/4                                  | 2 3/4                      | 2 1/8                             | 2 1/8        | 2 1/8        | 2 1/8        | 1 7/8        | 1 7/8         | 1 7/8         | 3 3/8                            | 3 3/4        | 3 3/4        | 3 3/4        | 3 7/8        | 3 7/8         | 4 5/8         |
| 2                   | 3 3/8                                  | 3 3/8                      | 2 3/4                             | 2 3/4        | 2 3/4        | 2 3/4        | 2 5/16       | 2 5/16        | 2 5/16        | 4 1/8                            | 4 3/8        | 4 3/8        | 4 3/8        | 5 5/8        | 5 5/8         | 5 3/4         |
| 2 1/2               | 3 7/8                                  | 3 7/8                      | 3 1/4                             | 3 1/4        | 3 1/4        | 3 1/4        | 2 3/4        | 2 3/4         | 2 3/4         | 4 7/8                            | 5 1/8        | 5 1/8        | 5 1/8        | 6 1/2        | 6 1/2         | 6 5/8         |
| 3                   | 4 3/4                                  | 4 3/4                      | 4                                 | 4            | 4            | 4            | 3 3/4        | 3 5/8         | 3 5/8         | 5 5/8                            | 5 7/8        | 5 7/8        | 5 7/8        | 6 5/8        | 6 7/8         | 7 3/4         |
| 3 1/2               | 5 1/4                                  | 5 1/4                      | 4 1/2                             | 4 1/2        | 4 1/8        | 4 1/8        | 4 1/8        | 4 1/8         | -             | 6 3/8                            | 6 1/2        | 6 3/8        | 6 3/8        | 7 1/2        | 7 3/8         | -             |
| 4                   | 5 7/8                                  | 5 7/8                      | 5                                 | 5            | 4 3/4        | 4 3/4        | 4 3/4        | 4 5/8         | 4 5/8         | 6 7/8                            | 7 1/8        | 7            | 7 5/8        | 8 1/8        | 8 1/4         | 9 1/4         |
| 4 1/2               | 6 1/2                                  | 6 1/2                      | 5 1/2                             | 5 1/2        | 5 5/16       | 5 5/16       | 5 5/16       | 5 5/16        | -             | 7                                | 7 3/4        | 7 5/8        | 8 1/4        | 9 3/8        | 9 1/8         | -             |
| 5                   | 7                                      | 7                          | 6 1/8                             | 6 1/8        | 5 13/16      | 5 13/16      | 5 13/16      | 5 5/8         | 5 5/8         | 7 3/4                            | 8 1/2        | 8 3/8        | 9 1/2        | 9 3/4        | 10            | 11            |
| 6                   | 8 1/4                                  | 8 1/4                      | 7 1/16                            | 7 1/16       | 6 7/8        | 6 7/8        | 6 7/8        | 6 3/4         | 6 3/4         | 8 3/4                            | 9 7/8        | 9 3/4        | 10 1/2       | 11 3/8       | 11 1/8        | 12 1/2        |
| 8                   | 10 3/8                                 | 10 3/8                     | 9 3/16                            | 9 3/16       | 8 7/8        | 8 7/8        | 8 3/4        | 8 1/2         | 8 1/2         | 11                               | 12 1/8       | 12           | 12 5/8       | 14 1/8       | 13 3/8        | 15 1/4        |
| 10                  | 12 1/2                                 | 12 1/4                     | 11 5/16                           | 11 5/16      | 10 13/16     | 10 13/16     | 10 7/8       | 10 1/2        | 10 5/8        | 13 3/8                           | 14 1/4       | 14 1/8       | 15 3/4       | 17 1/8       | 17 1/8        | 18 3/4        |
| 12                  | 14 3/4                                 | 14 1/2                     | 13 3/8                            | 13 3/8       | 12 7/8       | 12 7/8       | 12 3/4       | 12 3/4        | 12 1/2        | 16 1/8                           | 16 5/8       | 16 1/2       | 18           | 19 5/8       | 20 1/2        | 21 5/8        |
| 14                  | 16                                     | 15 3/4                     | 14 5/8                            | 14 5/8       | 14 1/4       | 14 1/4       | 14           | 14 1/4        | -             | 17 3/4                           | 19 1/8       | 19           | 19 3/8       | 20 1/2       | 22 3/4        | -             |
| 16                  | 18 1/4                                 | 18                         | 16 5/8                            | 16 5/8       | 16 1/4       | 16 1/4       | 16 1/4       | 16            | -             | 20 1/4                           | 21 1/4       | 21 1/8       | 22 1/4       | 22 5/8       | 25 1/4        | -             |
| 18                  | 20 3/4                                 | 20 1/2                     | 18 11/16                          | 18 11/16     | 18 1/2       | 18 1/2       | 18 1/4       | 18 1/4        | -             | 21 5/8                           | 23 1/2       | 23 3/8       | 24 1/8       | 25 1/8       | 27 3/4        | -             |
| 20                  | 22 3/4                                 | 22 1/2                     | 20 11/16                          | 20 11/16     | 20 1/2       | 20 1/2       | 20 1/2       | 20 1/4        | -             | 23 7/8                           | 25 3/4       | 25 1/2       | 26 7/8       | 27 1/2       | 29 3/4        | -             |
| 24                  | 27                                     | 26 3/4                     | 24 3/4                            | 24 3/4       | 24 3/4       | 24 3/4       | 24 3/4       | 24 1/4        | -             | 28 1/4                           | 30 1/2       | 30 1/4       | 31 1/8       | 33           | 35 1/2        | -             |

DIMENSIONS IN INCHES.

\*For Style CGI - see Table 3 for Inner Ring dimensions

In accordance with ASME B16.20, Inner Rings are mandatory for the following flange designations (see Table 3).

- Class 900 - NPS 24 to 48
- Class 1500 - NPS 12 to NPS 24
- Class 2500 - NPS 4 to NPS 12

ASME B16.20 does not include dimensions for NPS 1/4, 3/8 or 1/2, or Class 400 Flanges up to NPS 3 and Class 900 Flanges up to NPS 2 1/2.

# STYLE CG & CGI\* TO ASME B16.20 TO SUIT ASME B16.5 FLANGES

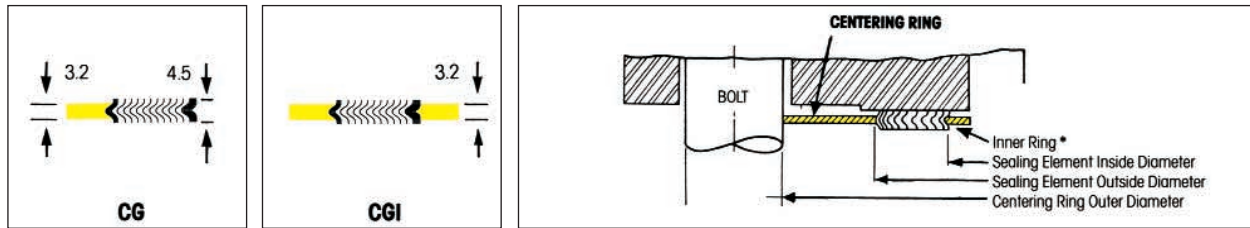

TABLE  
2

| NOM<br>PIPE<br>SIZE | OUTSIDE DIAMETER<br>OF SEALING ELEMENT |                            | INNER DIAMETER OF SEALING ELEMENT |              |              |              |              |               |               | OUTER DIAMETER OF CENTERING RING |              |              |              |              |               |               |
|---------------------|--|----------------------------|-----------------------------------|--------------|--------------|--------------|--------------|---------------|---------------|----------------------------------|--------------|--------------|--------------|--------------|---------------|---------------|
|                     | CLASS<br>150, 300<br>400, 600          | CLASS<br>900, 1500<br>2500 | CLASS<br>150                      | CLASS<br>300 | CLASS<br>400 | CLASS<br>600 | CLASS<br>900 | CLASS<br>1500 | CLASS<br>2500 | CLASS<br>150                     | CLASS<br>300 | CLASS<br>400 | CLASS<br>600 | CLASS<br>900 | CLASS<br>1500 | CLASS<br>2500 |
| 1/4                 | 22.2                                   | -                          | 12.7                              | 12.7         | 12.7         | 12.7         | -            | -             | -             | 44.5                             | 44.5         | 44.5         | 44.5         | -            | -             | -             |
| 1/2                 | 31.8                                   | 31.8                       | 19.1                              | 19.1         | 19.1         | 19.1         | 19.1         | 19.1          | 19.1          | 47.8                             | 54.1         | 54.1         | 54.1         | 63.5         | 63.5          | 69.9          |
| 3/4                 | 39.6                                   | 39.6                       | 25.4                              | 25.4         | 25.4         | 25.4         | 25.4         | 25.4          | 25.4          | 57.2                             | 66.8         | 66.8         | 66.8         | 69.9         | 69.9          | 76.2          |
| 1                   | 47.8                                   | 47.8                       | 31.8                              | 31.8         | 31.8         | 31.8         | 31.8         | 31.8          | 31.8          | 66.8                             | 73.2         | 73.2         | 73.2         | 79.5         | 79.5          | 85.9          |
| 1 1/4               | 60.5                                   | 60.5                       | 47.8                              | 47.8         | 47.8         | 47.8         | 39.6         | 39.6          | 39.6          | 76.2                             | 82.6         | 82.6         | 82.6         | 88.9         | 88.9          | 104.9         |
| 1 1/2               | 69.9                                   | 69.9                       | 54.1                              | 54.1         | 54.1         | 54.1         | 47.8         | 47.8          | 47.8          | 85.9                             | 95.3         | 95.3         | 95.3         | 98.6         | 98.6          | 117.6         |
| 2                   | 85.9                                   | 85.9                       | 69.9                              | 69.9         | 69.9         | 69.9         | 58.7         | 58.7          | 58.7          | 104.9                            | 111.3        | 111.3        | 111.3        | 143.0        | 143.0         | 146.1         |
| 2 1/2               | 98.6                                   | 98.6                       | 82.6                              | 82.6         | 82.6         | 82.6         | 69.9         | 69.9          | 69.9          | 124.0                            | 130.3        | 130.3        | 130.3        | 165.1        | 165.1         | 168.4         |
| 3                   | 120.7                                  | 120.7                      | 101.6                             | 101.6        | 101.6        | 101.6        | 95.3         | 92.2          | 92.2          | 136.7                            | 149.4        | 149.4        | 149.4        | 168.4        | 174.8         | 196.9         |
| 3 1/2               | 133.4                                  | 133.4                      | 114.3                             | 114.3        | 104.8        | 104.8        | 104.8        | 104.8         | -             | 161.9                            | 165.1        | 161.9        | 161.9        | 190.5        | 187.3         | -             |
| 4                   | 149.4                                  | 149.4                      | 127.0                             | 127.0        | 120.7        | 120.7        | 120.7        | 117.6         | 117.6         | 174.8                            | 181.1        | 177.8        | 193.8        | 206.5        | 209.6         | 235.0         |
| 4 1/2               | 165.1                                  | 165.1                      | 139.7                             | 139.7        | 134.9        | 134.9        | 134.9        | 134.9         | -             | 177.8                            | 196.9        | 193.7        | 209.6        | 238.1        | 231.8         | -             |
| 5                   | 177.8                                  | 177.8                      | 155.7                             | 155.7        | 147.6        | 147.6        | 147.6        | 143.0         | 143.0         | 196.9                            | 215.9        | 212.9        | 241.3        | 247.7        | 254.0         | 279.4         |
| 6                   | 209.6                                  | 209.6                      | 182.6                             | 182.6        | 174.8        | 174.8        | 174.8        | 171.5         | 171.5         | 222.3                            | 251.0        | 247.7        | 266.7        | 289.1        | 282.7         | 317.5         |
| 8                   | 263.7                                  | 257.3                      | 233.4                             | 233.4        | 225.6        | 225.6        | 222.3        | 215.9         | 215.9         | 279.4                            | 308.1        | 304.8        | 320.8        | 358.9        | 352.6         | 387.4         |
| 10                  | 317.5                                  | 311.2                      | 287.3                             | 287.3        | 274.6        | 274.6        | 276.4        | 266.7         | 270.0         | 339.9                            | 362.0        | 358.9        | 400.1        | 435.1        | 435.1         | 476.3         |
| 12                  | 374.7                                  | 368.3                      | 339.9                             | 339.9        | 327.2        | 327.2        | 323.9        | 323.9         | 317.5         | 409.7                            | 422.4        | 419.1        | 457.2        | 498.6        | 520.7         | 549.4         |
| 14                  | 406.4                                  | 400.1                      | 371.6                             | 371.6        | 362.0        | 362.0        | 355.6        | 362.0         | -             | 450.9                            | 485.9        | 482.6        | 492.3        | 520.7        | 577.9         | -             |
| 16                  | 463.6                                  | 457.2                      | 422.4                             | 422.4        | 412.8        | 412.8        | 412.8        | 406.4         | -             | 514.4                            | 539.8        | 536.7        | 565.2        | 574.8        | 641.4         | -             |
| 18                  | 527.1                                  | 520.7                      | 474.7                             | 474.7        | 469.9        | 469.9        | 463.6        | 463.6         | -             | 549.4                            | 596.9        | 593.9        | 612.9        | 638.3        | 704.9         | -             |
| 20                  | 577.9                                  | 571.5                      | 525.5                             | 525.5        | 520.7        | 520.7        | 520.7        | 514.4         | -             | 606.6                            | 654.1        | 647.7        | 682.8        | 698.5        | 755.7         | -             |
| 24                  | 685.8                                  | 679.5                      | 628.7                             | 628.7        | 628.7        | 628.7        | 628.7        | 616.0         | -             | 717.6                            | 774.7        | 768.4        | 790.7        | 838.2        | 901.7         | -             |

DIMENSIONS IN mm.

\*For Style CGI - see Table 3 for Inner Ring dimensions

In accordance with ASME B16.20, Inner Rings are mandatory on the following flange designations (see Table 3).

Class 900 - NPS 24 to 48

Class 1500 - NPS 12 to NPS 24

Class 2500 - NPS 4 to NPS 12

ASME B16.20 does not include dimensions for NPS 1/4, 3/2 or 4 1/2, or Class 400 Flanges up to NPS 3 and Class 900 Flanges up to NPS 2 1/2.

# STANDARD INSIDE DIAMETERS OF INNER RINGS FOR STYLE CGI GASKETS TO ASME B16.20 TO SUIT ASME B16.5 FLANGES

TABLE  
3

| NON PIPE SIZE | PRESSURE CLASS |        |       |        |       |        |       |        |       |        |       |        |       |        |
|---------------|----------------|--------|-------|--------|-------|--------|-------|--------|-------|--------|-------|--------|-------|--------|
|               | 150            |        | 300   |        | 400   |        | 600   |        | 900   |        | 1500  |        | 2500  |        |
| 1/2           | 0.56           | 14.22  | 0.56  | 14.22  | 0.56  | 14.22  | 0.56  | 14.22  | 0.56  | 14.22  | 0.56  | 14.22  | 0.56  | 14.22  |
| 3/4           | 0.81           | 20.57  | 0.81  | 20.57  | 0.81  | 20.57  | 0.81  | 20.57  | 0.81  | 20.57  | 0.81  | 20.57  | 0.81  | 20.57  |
| 1             | 1.06           | 26.92  | 1.06  | 26.92  | 1.06  | 26.92  | 1.06  | 26.92  | 1.06  | 26.92  | 1.06  | 26.92  | 1.06  | 26.92  |
| 1 1/4         | 1.50           | 38.10  | 1.50  | 38.10  | 1.50  | 38.10  | 1.50  | 38.10  | 1.31  | 33.27  | 1.31  | 33.27  | 1.31  | 33.27  |
| 1 1/2         | 1.75           | 44.45  | 1.75  | 44.45  | 1.75  | 44.45  | 1.75  | 44.45  | 1.63  | 41.40  | 1.63  | 41.40  | 1.63  | 41.40  |
| 2             | 2.19           | 55.63  | 2.19  | 55.63  | 2.19  | 55.63  | 2.19  | 55.63  | 2.06  | 52.32  | 2.06  | 52.32  | 2.06  | 52.52  |
| 2 1/2         | 2.62           | 66.55  | 2.62  | 66.55  | 2.62  | 66.55  | 2.62  | 66.55  | 2.50  | 63.60  | 2.50  | 63.50  | 2.50  | 63.50  |
| 3             | 3.19           | 81.03  | 3.10  | 78.74  | 3.10  | 78.74  | 3.10  | 78.74  | 3.10  | 78.74  | 3.10  | 78.74  | 3.10  | 78.74  |
| 4             | 4.19           | 106.43 | 4.19  | 106.43 | 4.04  | 102.62 | 4.04  | 102.62 | 4.04  | 102.62 | 3.85  | 97.79  | 3.85  | 97.79  |
| 5             | 5.19           | 131.83 | 5.19  | 131.63 | 5.05  | 128.27 | 5.05  | 128.27 | 5.05  | 128.27 | 4.90  | 124.46 | 4.90  | 124.46 |
| 6             | 6.19           | 157.23 | 6.19  | 157.23 | 6.10  | 154.64 | 6.10  | 154.94 | 6.10  | 154.95 | 5.80  | 147.32 | 5.80  | 147.32 |
| 8             | 8.50           | 215.90 | 8.50  | 215.90 | 8.10  | 205.74 | 8.10  | 205.74 | 7.75  | 196.85 | 7.75  | 196.85 | 7.75  | 196.85 |
| 10            | 10.56          | 288.22 | 10.56 | 268.22 | 10.05 | 255.27 | 10.05 | 255.27 | 9.69  | 246.13 | 9.69  | 246.13 | 9.69  | 246.13 |
| 12            | 12.50          | 317.50 | 12.50 | 317.50 | 12.10 | 307.34 | 12.10 | 307.34 | 11.50 | 292.10 | 11.50 | 292.10 | 11.50 | 292.10 |
| 14            | 13.75          | 549.28 | 13.75 | 349.25 | 13.50 | 342.80 | 13.50 | 342.90 | 12.63 | 320.80 | 12.63 | 320.80 | -     | -      |
| 16            | 15.75          | 400.05 | 15.75 | 400.05 | 15.35 | 389.89 | 15.35 | 389.89 | 14.75 | 374.65 | 14.50 | 388.30 | -     | -      |
| 18            | 17.69          | 449.33 | 17.69 | 449.33 | 17.25 | 438.15 | 17.25 | 438.15 | 16.75 | 425.45 | 16.75 | 425.45 | -     | -      |
| 20            | 19.69          | 500.13 | 19.69 | 500.13 | 19.25 | 488.95 | 19.25 | 488.95 | 19.00 | 482.60 | 18.75 | 476.25 | -     | -      |
| 24            | 23.75          | 603.25 | 23.75 | 603.25 | 23.25 | 590.55 | 23.25 | 590.65 | 23.25 | 590.55 | 22.75 | 577.85 | -     | -      |

DIMENSIONS IN INCHES & mm.

## STYLE CG & CGI TO SUIT ASME B16.5 & BS 1560 SMALL DIAMETER SCREWED OR SLIP-ON FLANGES

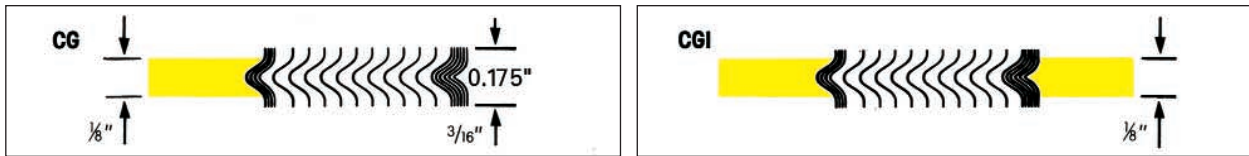

TABLE  
4

| Nom. Pipe Size | Inner Ring Inside Dia. |      | Sealing Element |      |              |      | Guide Ring Outside Diameter |      |           |      |           |      |           |      |           |      |            |      |
|----------------|------------------------|------|-----------------|------|--------------|------|-----------------------------|------|-----------|------|-----------|------|-----------|------|-----------|------|------------|------|
|                |                        |      | Inside Dia.     |      | Outside Dia. |      | Class 150                   |      | Class 300 |      | Class 400 |      | Class 600 |      | Class 900 |      | Class 1500 |      |
| 1/4            | -                      | -    | 1/16            | 14.3 | 7/8          | 22.2 | 1 1/4                       | 44.5 | 1 1/4     | 44.5 | 1 1/4     | 44.5 | 1 1/4     | 44.5 | -         | -    | -          | -    |
| 1/2            | 1/16                   | 14.3 | 15/16           | 23.8 | 1 1/4        | 31.8 | 1 1/8                       | 47.6 | 2 1/8     | 54.0 | 2 1/8     | 54.0 | 2 1/8     | 54.0 | 2 1/2     | 63.5 | 2 1/2      | 63.5 |
| 3/4            | 13/16                  | 20.6 | 1 1/16          | 30.2 | 1 1/16       | 39.7 | 2 1/4                       | 57.2 | 2 5/8     | 66.7 | 2 5/8     | 66.7 | 2 5/8     | 66.7 | 2 3/4     | 69.9 | 2 3/4      | 69.9 |
| 1              | 1 1/16                 | 27.0 | 1 1/16          | 36.5 | 1 7/8        | 47.6 | 2 5/8                       | 66.7 | 2 7/8     | 73.0 | 2 7/8     | 73.0 | 2 7/8     | 73.0 | 3 1/8     | 79.4 | 3 1/8      | 79.4 |
| 1 1/4          | 1 3/8                  | 34.9 | 1 7/8           | 47.6 | 2 3/8        | 60.3 | 3                           | 76.2 | 3 1/4     | 82.6 | 3 1/4     | 82.6 | 3 1/4     | 82.6 | 3 1/2     | 88.9 | 3 1/2      | 88.9 |
| 1 1/2          | 1 5/8                  | 41.3 | 2 1/8           | 54.0 | 2 3/4        | 69.9 | 3 3/8                       | 85.7 | 3 3/4     | 95.3 | 3 3/4     | 95.3 | 3 3/4     | 95.3 | 3 3/8     | 98.4 | 3 3/8      | 98.4 |

DIMENSIONS IN INCHES & mm.

NOTE: The above style CG & CGI spiral wound gaskets are dimensioned to suit existing screwed or slip-on flanges for NPS 1/4 to 1 1/2 ASME B16.5 & BS 1560 flanges.

# MAXIMUM BORE OF ASME B16.5 FLANGES

## FOR USE WITH STYLE CG & CGI SPIRAL WOUND GASKETS

This table shows the maximum bore of flanges for which the spiral-wound gasket dimensions shown are recommended considering the tolerances involved, possible eccentric installation, and the possibility that the gasket may extend into the assembled flange bore.

TABLE  
5

| FLANGE SIZE (NPS) | PRESSURE CLASS  |   |                             |   |  |                             |                             |                             |            |
|-------------------|---|---|-----------------------------|---|--|-----------------------------|-----------------------------|-----------------------------|------------|
|                   | 75  | 150   | 300                         | 400   | 600  | 900                         | 1500*                       | 2500*                       |            |
| 1/2               | No flanges  | WN flange only <sup>b</sup>   | No flanges<br>Use Class 600 | WN flange only <sup>b</sup>   | No flanges<br>Use Class 1500   | WN flange only <sup>b</sup> | WN flange only <sup>b</sup> | WN flange only <sup>b</sup> |            |
| 3/4               |   |   |                             |   |  |                             |                             |                             |            |
| 1                 |   |   |                             |   |  |                             |                             |                             |            |
| 1 1/4             |   | SO flange <sup>c</sup><br>WN flange <sup>b</sup>  |                             | SO flange <sup>c</sup><br>WN flange <sup>b</sup>  |  |                             |                             |                             |            |
| 1 1/2             |   | SO flange <sup>c</sup><br>WN flange, any bore <sup>b</sup>  |                             | SO flange <sup>c</sup><br>WN flange,<br>any bore  |  |                             |                             |                             |            |
| 2                 |   |   |                             |   |  |                             |                             |                             |            |
| 2 1/2             |   | SO flange<br>WN flange, any bore  |                             | SO flange <sup>c</sup><br>WN flange,<br>any bore  | WN flange with SW bore<br>(includes nozzle <sup>d</sup> but excludes<br>SO flange) |                             |                             |                             |            |
| 3                 |   |   |                             |   |  |                             |                             |                             |            |
| 4                 |   |   |                             |   |  |                             |                             |                             |            |
| 6                 |   | SO flange<br>WN flange, any bore  |                             | WN flange with<br>Schedule 10S bore<br>described in ASME B36.19M<br>(includes nozzle <sup>d</sup><br>but excludes<br>SO flange) | WN Flange with<br>Schedule 80 bore<br>(excludes nozzle<br>and<br>SO flange)        |                             |                             |                             | No flanges |
| 8                 |   |   |                             |   |  |                             |                             |                             |            |
| 10                |   |   |                             |   |  |                             |                             |                             |            |
| 12                |   |   |                             |   |  |                             |                             |                             |            |
| 14                |   | WN flange with<br>Schedule 10S bore described<br>in ASME B36.19M<br>(excludes nozzle <sup>d</sup><br>and<br>SO flange) <sup>e</sup> |                             | WN Flange with<br>Schedule 80 bore<br>(excludes nozzle<br>and<br>SO flange)   | No flanges   |                             |                             |                             |            |
| 16                |   |   |                             |   |  |                             |                             |                             |            |
| 18                |   |   |                             |   |  |                             |                             |                             |            |
| 20                |   |   |                             |   |  |                             |                             |                             |            |
| 24                | WN flange with<br>Schedule 10S bore described<br>in ASME B36.19M<br>(excludes nozzle <sup>d</sup><br>and<br>SO flange) <sup>e</sup> | WN Flange with<br>Schedule 80 bore<br>(excludes nozzle<br>and<br>SO flange)   | No flanges                  |   |  |                             |                             |                             |            |
| 24                |   |   |                             |   |  |                             |                             |                             |            |

Note: SO = slip on and threaded; WN = welding neck; SW = standard wall.

<sup>a</sup>Inner rings are required for Class 900 gaskets, NPS 24; Class 1500 gaskets, NPS 12 through NPS 24; and Class 2500 gaskets; NPS 4 through NPS 12. These inner rings may extend into the pipe bore a maximum of 0.06 inch (1.5 millimeters) under the worst combination of maximum bore, eccentric installation, and additive tolerances.

<sup>b</sup>In these sizes the gasket is suitable for welding-neck flange with a standard-wall bore, if the gasket and the flanges are assembled concentrically. This also applies to nozzle. It is the user's responsibility to determine if the gasket is satisfactory for a flange of any larger bore.

<sup>c</sup>Gaskets in these sizes are suitable for slip-on flanges only if the gaskets and flanges are assembled concentrically.

<sup>d</sup>A nozzle is a long welding neck; the bore equals the flange NPS.

<sup>e</sup>An NPS 24 gasket is suitable for nozzles.

\*Spiral wound gasket dimensions for use on screwed or slip-on flanges – see Table 4.

# STYLE CG & CGI TO ASME B16.20

## TO SUIT LARGE DIAMETER ASME B16.47 SERIES B FLANGES

### CLASS 75-300

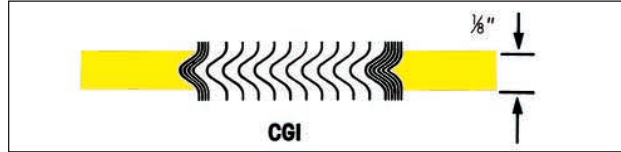
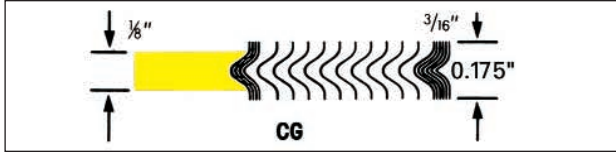

TABLE 6

| Nom. Pipe Size | CLASS 75        |              |                             |
|----------------|-----------------|--------------|-----------------------------|
|                | Sealing Element |              | Centering Ring Outside Dia. |
|                | Inside Dia.     | Outside Dia. |                             |
| 26             | 26 1/4          | 27           | 27 7/8                      |
| 28             | 28 1/4          | 29 1/8       | 29 7/8                      |
| 30             | 30 1/4          | 31 1/8       | 31 7/8                      |
| 32             | 32 1/4          | 33 1/8       | 33 7/8                      |
| 34             | 34 1/4          | 35 1/8       | 35 7/8                      |
| 36             | 36 1/4          | 37 1/4       | 38 9/16                     |
| 38             | -               | -            | -                           |
| 40             | -               | -            | -                           |
| 42             | 42 1/4          | 43 3/4       | 44 5/16                     |
| 44             | -               | -            | -                           |
| 46             | -               | -            | -                           |
| 48             | 48 3/8          | 49 1/2       | 50 1/2                      |
| 50             | -               | -            | -                           |
| 52             | -               | -            | -                           |
| 54             | 54 3/8          | 55 5/8       | 56 5/8                      |
| 56             | --              | -            | -                           |
| 58             | -               | -            | -                           |
| 60             | 60 1/2          | 61 3/4       | 62 7/8                      |

| Nom. Pipe Size | Inner Ring Inside Dia. | CLASS 150       |              | Centering Ring Outside Dia. |
|----------------|------------------------|-----------------|--------------|-----------------------------|
|                |                        | Sealing Element |              |                             |
|                |                        | Inside Dia.     | Outside Dia. |                             |
| 26             | 25 3/4                 | 26 1/2          | 27 1/2       | 28 9/16                     |
| 28             | 27 3/4                 | 28 1/2          | 29 1/2       | 30 9/16                     |
| 30             | 29 3/4                 | 30 1/2          | 31 1/2       | 32 9/16                     |
| 32             | 31 3/4                 | 32 1/2          | 33 1/2       | 34 11/16                    |
| 34             | 33 3/4                 | 34 1/2          | 35 3/4       | 36 13/16                    |
| 36             | 35 3/4                 | 36 1/2          | 37 3/4       | 38 7/8                      |
| 38             | 37 3/4                 | 38 3/8          | 39 3/4       | 41 1/8                      |
| 40             | 39 3/4                 | 40 1/4          | 41 7/8       | 43 7/8                      |
| 42             | 41 3/4                 | 42 1/2          | 43 7/8       | 45 7/8                      |
| 44             | 43 3/4                 | 44 1/4          | 45 7/8       | 47 7/8                      |
| 46             | 45 3/4                 | 46 1/2          | 48 3/16      | 49 7/16                     |
| 48             | 47 3/4                 | 48 1/2          | 50           | 51 7/16                     |
| 50             | 49 3/4                 | 50 1/2          | 52 3/16      | 53 7/16                     |
| 52             | 51 3/4                 | 52 1/2          | 54 3/16      | 55 7/16                     |
| 54             | 53 3/4                 | 54 1/2          | 56           | 57 5/8                      |
| 56             | 56                     | 56 7/8          | 58 3/16      | 59 5/8                      |
| 58             | 58 7/16                | 59 7/16         | 60 3/16      | 62 3/16                     |
| 60             | 60 7/16                | 61 5/16         | 62 7/16      | 64 3/16                     |

| Nom. Pipe Size | Inner Ring Inside Dia. | CLASS 300       |              | Centering Ring Outside Dia. |
|----------------|------------------------|-----------------|--------------|-----------------------------|
|                |                        | Sealing Element |              |                             |
|                |                        | Inside Dia.     | Outside Dia. |                             |
| 26             | 25 3/4                 | 26 1/2          | 28           | 30 3/8                      |
| 28             | 27 3/4                 | 28 1/2          | 30           | 32 1/2                      |
| 30             | 29 3/4                 | 30 1/2          | 32           | 34 7/8                      |
| 32             | 31 3/4                 | 32 1/2          | 34           | 37                          |
| 34             | 33 3/4                 | 34 1/2          | 36           | 39 7/8                      |
| 36             | 35 3/4                 | 36 1/2          | 38           | 41 1/4                      |
| 38             | 38 1/4                 | 39 3/4          | 41 1/4       | 43 1/4                      |
| 40             | 40 1/4                 | 41 3/4          | 43 3/4       | 45 1/4                      |
| 42             | 42 3/4                 | 43 3/4          | 45 1/4       | 47 1/4                      |
| 44             | 44 1/4                 | 45 3/4          | 47 1/4       | 49 1/4                      |
| 46             | 46 3/8                 | 47 7/8          | 49 3/8       | 51 7/8                      |
| 48             | 48 1/2                 | 49 3/4          | 51 5/8       | 53 7/8                      |
| 50             | 49 7/8                 | 51 7/8          | 53 3/8       | 55 7/8                      |
| 52             | 51 7/8                 | 53 3/8          | 55 3/8       | 57 7/8                      |
| 54             | 53 3/4                 | 55 1/4          | 57 1/4       | 60 1/4                      |
| 56             | 56 1/4                 | 58 1/4          | 60           | 62 3/4                      |
| 58             | 58 7/16                | 60 7/16         | 61 15/16     | 65 3/16                     |
| 60             | 61 5/16                | 62 7/16         | 64 3/16      | 67 3/16                     |

DIMENSIONS IN INCHES.

NOTE: Gasket dimensions to suit Class 75 flanges are not specified in ASME B16.20. These gaskets have been dimensioned to suit the flanges.

# STYLE CG & CGI TO ASME B16.20 TO SUIT LARGE DIAMETER ASME B16.47 SERIES B FLANGES CLASS 400-900

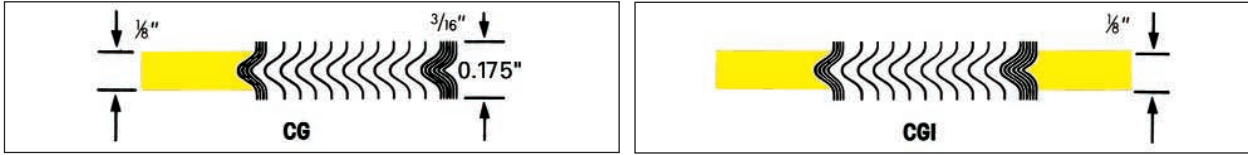

TABLE 6.1

| CLASS 400      |                                |                                |                                |                                | CLASS 600      |                                |                                |                                |                                | CLASS 900*     |                                |                                |                                |                                |
|----------------|--------------------------------|--------------------------------|--------------------------------|--------------------------------|----------------|--------------------------------|--------------------------------|--------------------------------|--------------------------------|----------------|--------------------------------|--------------------------------|--------------------------------|--------------------------------|
| Nom. Pipe Size | Inner Ring Inside Dia.         | Sealing Element                |                                | Centering Ring Outside Dia.    | Nom. Pipe Size | Inner Ring Inside Dia.         | Sealing Element                |                                | Centering Ring Outside Dia.    | Nom. Pipe Size | Inner Ring Inside Dia.         | Sealing Element                |                                | Centering Ring Outside Dia.    |
|                |                                | Inside Dia.                    | Outside Dia.                   |                                |                |                                | Inside Dia.                    | Outside Dia.                   |                                |                |                                | Inside Dia.                    | Outside Dia.                   |                                |
| 26             | 25 <sup>3</sup> / <sub>4</sub> | 26 <sup>1</sup> / <sub>4</sub> | 27 <sup>1</sup> / <sub>2</sub> | 29 <sup>3</sup> / <sub>8</sub> | 26             | 25 <sup>3</sup> / <sub>8</sub> | 26 <sup>1</sup> / <sub>8</sub> | 28 <sup>1</sup> / <sub>8</sub> | 30 <sup>1</sup> / <sub>8</sub> | 26             | 26 <sup>1</sup> / <sub>4</sub> | 27 <sup>1</sup> / <sub>4</sub> | 29 <sup>1</sup> / <sub>2</sub> | 33                             |
| 28             | 27 <sup>5</sup> / <sub>8</sub> | 28 <sup>1</sup> / <sub>8</sub> | 29 <sup>1</sup> / <sub>2</sub> | 31 <sup>1</sup> / <sub>2</sub> | 28             | 27                             | 27 <sup>3</sup> / <sub>4</sub> | 29 <sup>3</sup> / <sub>4</sub> | 32 <sup>1</sup> / <sub>4</sub> | 28             | 28 <sup>1</sup> / <sub>4</sub> | 29 <sup>1</sup> / <sub>4</sub> | 31 <sup>1</sup> / <sub>2</sub> | 35 <sup>1</sup> / <sub>2</sub> |
| 30             | 29 <sup>5</sup> / <sub>8</sub> | 30 <sup>1</sup> / <sub>8</sub> | 31 <sup>3</sup> / <sub>4</sub> | 33 <sup>3</sup> / <sub>4</sub> | 30             | 29 <sup>5</sup> / <sub>8</sub> | 30 <sup>5</sup> / <sub>8</sub> | 32 <sup>5</sup> / <sub>8</sub> | 34 <sup>5</sup> / <sub>8</sub> | 30             | 30 <sup>3</sup> / <sub>4</sub> | 31 <sup>3</sup> / <sub>4</sub> | 33 <sup>3</sup> / <sub>4</sub> | 37 <sup>3</sup> / <sub>4</sub> |
| 32             | 31 <sup>1</sup> / <sub>2</sub> | 32                             | 33 <sup>7</sup> / <sub>8</sub> | 35 <sup>7</sup> / <sub>8</sub> | 32             | 31 <sup>1</sup> / <sub>4</sub> | 32 <sup>3</sup> / <sub>4</sub> | 34 <sup>3</sup> / <sub>4</sub> | 36 <sup>3</sup> / <sub>4</sub> | 32             | 33                             | 34                             | 36                             | 40                             |
| 34             | 33 <sup>1</sup> / <sub>2</sub> | 34 <sup>1</sup> / <sub>8</sub> | 35 <sup>7</sup> / <sub>8</sub> | 37 <sup>7</sup> / <sub>8</sub> | 34             | 33 <sup>1</sup> / <sub>2</sub> | 35                             | 37                             | 39 <sup>1</sup> / <sub>4</sub> | 34             | 35 <sup>1</sup> / <sub>4</sub> | 36 <sup>1</sup> / <sub>4</sub> | 38 <sup>1</sup> / <sub>4</sub> | 42 <sup>1</sup> / <sub>4</sub> |
| 36             | 35 <sup>3</sup> / <sub>8</sub> | 36 <sup>1</sup> / <sub>8</sub> | 38                             | 40 <sup>1</sup> / <sub>4</sub> | 36             | 35 <sup>1</sup> / <sub>2</sub> | 37                             | 39                             | 41 <sup>1</sup> / <sub>4</sub> | 36             | 36 <sup>1</sup> / <sub>4</sub> | 37 <sup>1</sup> / <sub>4</sub> | 39 <sup>1</sup> / <sub>4</sub> | 44 <sup>1</sup> / <sub>4</sub> |
| 38             | 37 <sup>1</sup> / <sub>2</sub> | 38 <sup>1</sup> / <sub>4</sub> | 40 <sup>1</sup> / <sub>4</sub> | 42 <sup>1</sup> / <sub>4</sub> | 38             | 37 <sup>1</sup> / <sub>2</sub> | 39                             | 41                             | 43 <sup>1</sup> / <sub>2</sub> | 38             | 39 <sup>3</sup> / <sub>4</sub> | 40 <sup>3</sup> / <sub>4</sub> | 42 <sup>3</sup> / <sub>4</sub> | 47 <sup>1</sup> / <sub>4</sub> |
| 40             | 39 <sup>3</sup> / <sub>8</sub> | 40 <sup>3</sup> / <sub>8</sub> | 42 <sup>3</sup> / <sub>8</sub> | 44 <sup>3</sup> / <sub>8</sub> | 40             | 39 <sup>3</sup> / <sub>4</sub> | 41 <sup>1</sup> / <sub>4</sub> | 43 <sup>1</sup> / <sub>4</sub> | 45 <sup>1</sup> / <sub>2</sub> | 40             | 41 <sup>3</sup> / <sub>4</sub> | 43 <sup>3</sup> / <sub>4</sub> | 45 <sup>3</sup> / <sub>4</sub> | 49 <sup>1</sup> / <sub>4</sub> |
| 42             | 41 <sup>3</sup> / <sub>8</sub> | 42 <sup>3</sup> / <sub>8</sub> | 44 <sup>3</sup> / <sub>8</sub> | 46 <sup>3</sup> / <sub>8</sub> | 42             | 42                             | 43 <sup>1</sup> / <sub>2</sub> | 45 <sup>1</sup> / <sub>2</sub> | 48                             | 42             | 43 <sup>3</sup> / <sub>4</sub> | 45 <sup>3</sup> / <sub>4</sub> | 47 <sup>3</sup> / <sub>4</sub> | 51 <sup>1</sup> / <sub>4</sub> |
| 44             | 43 <sup>1</sup> / <sub>2</sub> | 44 <sup>1</sup> / <sub>2</sub> | 46 <sup>1</sup> / <sub>2</sub> | 48 <sup>1</sup> / <sub>2</sub> | 44             | 43 <sup>3</sup> / <sub>4</sub> | 45 <sup>3</sup> / <sub>4</sub> | 47 <sup>3</sup> / <sub>4</sub> | 50                             | 44             | 45 <sup>1</sup> / <sub>2</sub> | 47 <sup>1</sup> / <sub>2</sub> | 49 <sup>1</sup> / <sub>2</sub> | 53 <sup>7</sup> / <sub>8</sub> |
| 46             | 46                             | 47                             | 49                             | 50 <sup>3</sup> / <sub>4</sub> | 46             | 45 <sup>3</sup> / <sub>4</sub> | 47 <sup>3</sup> / <sub>4</sub> | 49 <sup>3</sup> / <sub>4</sub> | 52 <sup>1</sup> / <sub>4</sub> | 46             | 48                             | 50                             | 52                             | 56 <sup>1</sup> / <sub>2</sub> |
| 48             | 47 <sup>1</sup> / <sub>2</sub> | 49                             | 51                             | 53                             | 48             | 48                             | 50                             | 52                             | 54 <sup>3</sup> / <sub>4</sub> | 48             | 50                             | 52                             | 54                             | 58 <sup>1</sup> / <sub>2</sub> |
| 50             | 49 <sup>1</sup> / <sub>2</sub> | 51                             | 53                             | 55 <sup>1</sup> / <sub>4</sub> | 50             | 50                             | 52                             | 54                             | 57                             | 50             | -                              | -                              | -                              | -                              |
| 52             | 51 <sup>1</sup> / <sub>2</sub> | 53                             | 55                             | 57 <sup>1</sup> / <sub>4</sub> | 52             | 52                             | 54                             | 56                             | 59                             | 52             | -                              | -                              | -                              | -                              |
| 54             | 53 <sup>1</sup> / <sub>4</sub> | 55 <sup>1</sup> / <sub>4</sub> | 57 <sup>1</sup> / <sub>4</sub> | 59 <sup>3</sup> / <sub>4</sub> | 54             | 54 <sup>1</sup> / <sub>4</sub> | 56 <sup>1</sup> / <sub>4</sub> | 58 <sup>1</sup> / <sub>4</sub> | 61 <sup>1</sup> / <sub>4</sub> | 54             | -                              | -                              | -                              | -                              |
| 56             | 55 <sup>1</sup> / <sub>4</sub> | 57 <sup>1</sup> / <sub>4</sub> | 59 <sup>1</sup> / <sub>4</sub> | 61 <sup>3</sup> / <sub>4</sub> | 56             | 56 <sup>1</sup> / <sub>4</sub> | 58 <sup>1</sup> / <sub>4</sub> | 60 <sup>1</sup> / <sub>4</sub> | 63 <sup>1</sup> / <sub>2</sub> | 56             | -                              | -                              | -                              | -                              |
| 58             | 57 <sup>1</sup> / <sub>4</sub> | 59 <sup>1</sup> / <sub>4</sub> | 61 <sup>1</sup> / <sub>4</sub> | 63 <sup>3</sup> / <sub>4</sub> | 58             | 58                             | 60 <sup>1</sup> / <sub>2</sub> | 62 <sup>1</sup> / <sub>2</sub> | 65 <sup>1</sup> / <sub>2</sub> | 58             | -                              | -                              | -                              | -                              |
| 60             | 59 <sup>3</sup> / <sub>4</sub> | 61 <sup>3</sup> / <sub>4</sub> | 63 <sup>3</sup> / <sub>4</sub> | 66 <sup>1</sup> / <sub>4</sub> | 60             | 60 <sup>1</sup> / <sub>4</sub> | 62 <sup>3</sup> / <sub>4</sub> | 64 <sup>3</sup> / <sub>4</sub> | 68 <sup>1</sup> / <sub>4</sub> | 60             | -                              | -                              | -                              | -                              |

DIMENSIONS IN INCHES.

NOTE: There are no class 900 flanges NPS 50 and larger.  
\*Inner rings are mandatory for class 900 flanges, NPS 26 to 48.

# STYLE CG & CGI TO ASME B16.20 TO SUIT LARGE DIAMETER ASME B16.47 SERIES A FLANGES CLASS 150-300

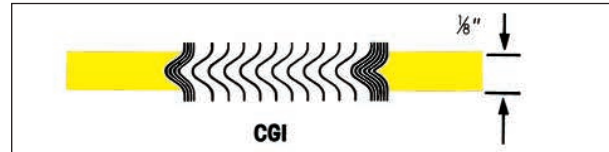
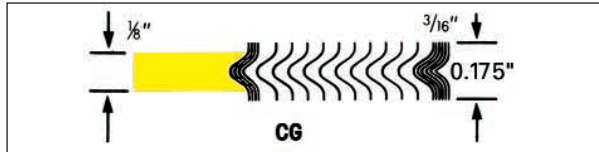

TABLE  
7

| CLASS 150      |                                |                                |                                |                                |
|----------------|--------------------------------|--------------------------------|--------------------------------|--------------------------------|
| Nom. Pipe Size | Inner Ring Inside Dia.         | Sealing Element                |                                | Centering Ring Outside Dia.    |
|                |                                | Inside Dia.                    | Outside Dia.                   |                                |
| 22             | —                              | 22 <sup>3</sup> / <sub>4</sub> | 24                             | 26                             |
| 26             | 25 <sup>3</sup> / <sub>4</sub> | 26 <sup>1</sup> / <sub>2</sub> | 27 <sup>3</sup> / <sub>4</sub> | 30 <sup>1</sup> / <sub>2</sub> |
| 28             | 27 <sup>3</sup> / <sub>4</sub> | 28 <sup>1</sup> / <sub>2</sub> | 29 <sup>3</sup> / <sub>4</sub> | 32 <sup>3</sup> / <sub>4</sub> |
| 30             | 29 <sup>3</sup> / <sub>4</sub> | 30 <sup>1</sup> / <sub>2</sub> | 31 <sup>3</sup> / <sub>4</sub> | 34 <sup>3</sup> / <sub>4</sub> |
| 32             | 31 <sup>3</sup> / <sub>4</sub> | 32 <sup>1</sup> / <sub>2</sub> | 33 <sup>7</sup> / <sub>8</sub> | 37                             |
| 34             | 33 <sup>3</sup> / <sub>4</sub> | 34 <sup>1</sup> / <sub>2</sub> | 35 <sup>7</sup> / <sub>8</sub> | 39                             |
| 36             | 35 <sup>3</sup> / <sub>4</sub> | 36 <sup>1</sup> / <sub>2</sub> | 38 <sup>1</sup> / <sub>8</sub> | 41 <sup>1</sup> / <sub>4</sub> |
| 38             | 37 <sup>3</sup> / <sub>4</sub> | 38 <sup>1</sup> / <sub>2</sub> | 40 <sup>1</sup> / <sub>8</sub> | 43 <sup>3</sup> / <sub>4</sub> |
| 40             | 39 <sup>3</sup> / <sub>4</sub> | 40 <sup>1</sup> / <sub>2</sub> | 42 <sup>1</sup> / <sub>8</sub> | 45 <sup>3</sup> / <sub>4</sub> |
| 42             | 41 <sup>3</sup> / <sub>4</sub> | 42 <sup>1</sup> / <sub>2</sub> | 44 <sup>1</sup> / <sub>4</sub> | 48                             |
| 44             | 43 <sup>3</sup> / <sub>4</sub> | 44 <sup>1</sup> / <sub>2</sub> | 46 <sup>3</sup> / <sub>8</sub> | 50 <sup>1</sup> / <sub>4</sub> |
| 46             | 45 <sup>3</sup> / <sub>4</sub> | 46 <sup>1</sup> / <sub>2</sub> | 48 <sup>3</sup> / <sub>8</sub> | 52 <sup>1</sup> / <sub>4</sub> |
| 48             | 47 <sup>3</sup> / <sub>4</sub> | 48 <sup>1</sup> / <sub>2</sub> | 50 <sup>3</sup> / <sub>8</sub> | 54 <sup>1</sup> / <sub>2</sub> |
| 50             | 49 <sup>3</sup> / <sub>4</sub> | 50 <sup>1</sup> / <sub>2</sub> | 52 <sup>1</sup> / <sub>2</sub> | 56 <sup>1</sup> / <sub>2</sub> |
| 52             | 51 <sup>3</sup> / <sub>4</sub> | 52 <sup>1</sup> / <sub>2</sub> | 54 <sup>1</sup> / <sub>2</sub> | 58 <sup>3</sup> / <sub>4</sub> |
| 54             | 53 <sup>1</sup> / <sub>2</sub> | 54 <sup>1</sup> / <sub>2</sub> | 56 <sup>1</sup> / <sub>2</sub> | 61                             |
| 56             | 55 <sup>1</sup> / <sub>2</sub> | 56 <sup>1</sup> / <sub>2</sub> | 58 <sup>1</sup> / <sub>2</sub> | 63 <sup>3</sup> / <sub>4</sub> |
| 58             | 57 <sup>1</sup> / <sub>2</sub> | 58 <sup>1</sup> / <sub>2</sub> | 60 <sup>1</sup> / <sub>2</sub> | 65 <sup>1</sup> / <sub>2</sub> |
| 60             | 59 <sup>1</sup> / <sub>2</sub> | 60 <sup>1</sup> / <sub>2</sub> | 62 <sup>1</sup> / <sub>2</sub> | 67 <sup>1</sup> / <sub>2</sub> |

| CLASS 300      |                                |                                |                                |                                |
|----------------|--------------------------------|--------------------------------|--------------------------------|--------------------------------|
| Nom. Pipe Size | Inner Ring Inside Dia.         | Sealing Element                |                                | Centering Ring Outside Dia.    |
|                |                                | Inside Dia.                    | Outside Dia.                   |                                |
| 22             | —                              | 22 <sup>3</sup> / <sub>4</sub> | 24 <sup>3</sup> / <sub>4</sub> | 27 <sup>3</sup> / <sub>4</sub> |
| 26             | 25 <sup>3</sup> / <sub>4</sub> | 27                             | 29                             | 32 <sup>7</sup> / <sub>8</sub> |
| 28             | 27 <sup>3</sup> / <sub>4</sub> | 29                             | 31                             | 35 <sup>3</sup> / <sub>8</sub> |
| 30             | 29 <sup>3</sup> / <sub>4</sub> | 31 <sup>1</sup> / <sub>4</sub> | 33 <sup>3</sup> / <sub>4</sub> | 37 <sup>1</sup> / <sub>2</sub> |
| 32             | 31 <sup>3</sup> / <sub>4</sub> | 33 <sup>1</sup> / <sub>2</sub> | 35 <sup>1</sup> / <sub>2</sub> | 39 <sup>5</sup> / <sub>8</sub> |
| 34             | 33 <sup>3</sup> / <sub>4</sub> | 35 <sup>1</sup> / <sub>2</sub> | 37 <sup>1</sup> / <sub>2</sub> | 41 <sup>5</sup> / <sub>8</sub> |
| 36             | 35 <sup>3</sup> / <sub>4</sub> | 37 <sup>3</sup> / <sub>8</sub> | 39 <sup>3</sup> / <sub>8</sub> | 44                             |
| 38             | 37 <sup>1</sup> / <sub>2</sub> | 38 <sup>1</sup> / <sub>2</sub> | 40                             | 41 <sup>1</sup> / <sub>2</sub> |
| 40             | 39 <sup>1</sup> / <sub>2</sub> | 40 <sup>1</sup> / <sub>4</sub> | 42 <sup>1</sup> / <sub>8</sub> | 43 <sup>7</sup> / <sub>8</sub> |
| 42             | 41 <sup>1</sup> / <sub>2</sub> | 42 <sup>3</sup> / <sub>4</sub> | 44 <sup>1</sup> / <sub>8</sub> | 45 <sup>7</sup> / <sub>8</sub> |
| 44             | 43 <sup>1</sup> / <sub>2</sub> | 44 <sup>1</sup> / <sub>2</sub> | 46 <sup>1</sup> / <sub>2</sub> | 48                             |
| 46             | 45 <sup>5</sup> / <sub>8</sub> | 46 <sup>3</sup> / <sub>8</sub> | 48 <sup>3</sup> / <sub>8</sub> | 50 <sup>5</sup> / <sub>8</sub> |
| 48             | 47 <sup>5</sup> / <sub>8</sub> | 48 <sup>5</sup> / <sub>8</sub> | 50 <sup>5</sup> / <sub>8</sub> | 52 <sup>5</sup> / <sub>8</sub> |
| 50             | 49                             | 51                             | 53                             | 54 <sup>1</sup> / <sub>4</sub> |
| 52             | 52                             | 53                             | 55                             | 56 <sup>1</sup> / <sub>4</sub> |
| 54             | 53 <sup>1</sup> / <sub>4</sub> | 55 <sup>1</sup> / <sub>4</sub> | 57 <sup>1</sup> / <sub>4</sub> | 58 <sup>3</sup> / <sub>4</sub> |
| 56             | 55 <sup>1</sup> / <sub>4</sub> | 57 <sup>1</sup> / <sub>4</sub> | 59 <sup>1</sup> / <sub>4</sub> | 60 <sup>3</sup> / <sub>4</sub> |
| 58             | 57                             | 59 <sup>1</sup> / <sub>2</sub> | 61 <sup>1</sup> / <sub>2</sub> | 62 <sup>3</sup> / <sub>4</sub> |
| 60             | 60                             | 61 <sup>1</sup> / <sub>2</sub> | 63 <sup>1</sup> / <sub>2</sub> | 64 <sup>3</sup> / <sub>4</sub> |

DIMENSIONS IN INCHES.

The above style CG gasket dimensions are also suitable for NPS 26 to 48 class 150 and NPS 26 to 36 class 300 BS 3293 flanges.

# STYLE CG & CGI TO ASME B16.20

## TO SUIT LARGE DIAMETER ASME B16.47 SERIES A FLANGES

### CLASS 400-600-900



TABLE 7.1

| CLASS 400      |                                |                                |                                |                                | CLASS 600      |                                |                                |                                |                                | CLASS 900*     |                                |                                |                                |                                |
|----------------|--------------------------------|--------------------------------|--------------------------------|--------------------------------|----------------|--------------------------------|--------------------------------|--------------------------------|--------------------------------|----------------|--------------------------------|--------------------------------|--------------------------------|--------------------------------|
| Nom. Pipe Size | Inner Ring Inside Dia.         | Sealing Element                |                                | Centering Ring Outside Dia.    | Nom. Pipe Size | Inner Ring Inside Dia.         | Sealing Element                |                                | Centering Ring Outside Dia.    | Nom. Pipe Size | Inner Ring Inside Dia.         | Sealing Element                |                                | Centering Ring Outside Dia.    |
|                |                                | Inside Dia.                    | Outside Dia.                   |                                |                |                                | Inside Dia.                    | Outside Dia.                   |                                |                |                                | Inside Dia.                    | Outside Dia.                   |                                |
| 22             | -                              | 22 <sup>3</sup> / <sub>4</sub> | 24 <sup>3</sup> / <sub>4</sub> | 27 <sup>5</sup> / <sub>8</sub> | 22             | -                              | 22 <sup>3</sup> / <sub>4</sub> | 24 <sup>3</sup> / <sub>4</sub> | 28 <sup>7</sup> / <sub>8</sub> | 22             | -                              | -                              | -                              | -                              |
| 26             | 26                             | 27                             | 29                             | 32 <sup>3</sup> / <sub>4</sub> | 26             | 25 <sup>1</sup> / <sub>2</sub> | 27                             | 29                             | 34 <sup>1</sup> / <sub>8</sub> | 26             | 26                             | 27                             | 29                             | 34 <sup>3</sup> / <sub>4</sub> |
| 28             | 28                             | 29                             | 31                             | 35 <sup>1</sup> / <sub>8</sub> | 28             | 27 <sup>1</sup> / <sub>2</sub> | 29                             | 31                             | 36                             | 28             | 28                             | 29                             | 31                             | 37 <sup>1</sup> / <sub>4</sub> |
| 30             | 29 <sup>3</sup> / <sub>4</sub> | 31 <sup>1</sup> / <sub>4</sub> | 33 <sup>1</sup> / <sub>4</sub> | 37 <sup>1</sup> / <sub>4</sub> | 30             | 29 <sup>3</sup> / <sub>4</sub> | 31 <sup>1</sup> / <sub>4</sub> | 33 <sup>1</sup> / <sub>4</sub> | 38 <sup>1</sup> / <sub>4</sub> | 30             | 30 <sup>1</sup> / <sub>4</sub> | 31 <sup>1</sup> / <sub>4</sub> | 33 <sup>1</sup> / <sub>4</sub> | 39 <sup>3</sup> / <sub>4</sub> |
| 32             | 32                             | 33 <sup>1</sup> / <sub>2</sub> | 35 <sup>1</sup> / <sub>2</sub> | 39 <sup>1</sup> / <sub>2</sub> | 32             | 32                             | 33 <sup>1</sup> / <sub>2</sub> | 35 <sup>1</sup> / <sub>2</sub> | 40 <sup>1</sup> / <sub>4</sub> | 32             | 32                             | 33 <sup>1</sup> / <sub>2</sub> | 35 <sup>1</sup> / <sub>2</sub> | 42 <sup>1</sup> / <sub>4</sub> |
| 34             | 34                             | 35 <sup>1</sup> / <sub>2</sub> | 37 <sup>1</sup> / <sub>2</sub> | 41 <sup>1</sup> / <sub>2</sub> | 34             | 34                             | 35 <sup>1</sup> / <sub>2</sub> | 37 <sup>1</sup> / <sub>2</sub> | 42 <sup>1</sup> / <sub>4</sub> | 34             | 34                             | 35 <sup>1</sup> / <sub>2</sub> | 37 <sup>1</sup> / <sub>2</sub> | 44 <sup>3</sup> / <sub>4</sub> |
| 36             | 36 <sup>1</sup> / <sub>8</sub> | 37 <sup>5</sup> / <sub>8</sub> | 39 <sup>5</sup> / <sub>8</sub> | 44                             | 36             | 36 <sup>1</sup> / <sub>8</sub> | 37 <sup>5</sup> / <sub>8</sub> | 39 <sup>5</sup> / <sub>8</sub> | 44 <sup>1</sup> / <sub>2</sub> | 36             | 36 <sup>1</sup> / <sub>4</sub> | 37 <sup>3</sup> / <sub>4</sub> | 39 <sup>3</sup> / <sub>4</sub> | 47 <sup>1</sup> / <sub>4</sub> |
| 38             | 37 <sup>1</sup> / <sub>2</sub> | 38 <sup>1</sup> / <sub>4</sub> | 40 <sup>1</sup> / <sub>4</sub> | 42 <sup>1</sup> / <sub>4</sub> | 38             | 37 <sup>1</sup> / <sub>2</sub> | 39                             | 41                             | 43 <sup>1</sup> / <sub>2</sub> | 38             | 39 <sup>3</sup> / <sub>4</sub> | 40 <sup>3</sup> / <sub>4</sub> | 42 <sup>3</sup> / <sub>4</sub> | 47 <sup>1</sup> / <sub>4</sub> |
| 40             | 39 <sup>3</sup> / <sub>8</sub> | 40 <sup>3</sup> / <sub>8</sub> | 42 <sup>3</sup> / <sub>8</sub> | 44 <sup>3</sup> / <sub>8</sub> | 40             | 39 <sup>3</sup> / <sub>4</sub> | 41 <sup>1</sup> / <sub>4</sub> | 43 <sup>1</sup> / <sub>4</sub> | 45 <sup>1</sup> / <sub>2</sub> | 40             | 41 <sup>3</sup> / <sub>4</sub> | 43 <sup>1</sup> / <sub>4</sub> | 45 <sup>1</sup> / <sub>4</sub> | 49 <sup>1</sup> / <sub>4</sub> |
| 42             | 41 <sup>3</sup> / <sub>8</sub> | 42 <sup>3</sup> / <sub>8</sub> | 44 <sup>3</sup> / <sub>8</sub> | 46 <sup>3</sup> / <sub>8</sub> | 42             | 42                             | 43 <sup>1</sup> / <sub>2</sub> | 45 <sup>1</sup> / <sub>2</sub> | 48                             | 42             | 43 <sup>3</sup> / <sub>4</sub> | 45 <sup>1</sup> / <sub>4</sub> | 47 <sup>1</sup> / <sub>4</sub> | 51 <sup>1</sup> / <sub>4</sub> |
| 44             | 43 <sup>1</sup> / <sub>2</sub> | 44 <sup>1</sup> / <sub>2</sub> | 46 <sup>1</sup> / <sub>2</sub> | 48 <sup>1</sup> / <sub>2</sub> | 44             | 43 <sup>3</sup> / <sub>4</sub> | 45 <sup>3</sup> / <sub>4</sub> | 47 <sup>3</sup> / <sub>4</sub> | 50                             | 44             | 45 <sup>1</sup> / <sub>2</sub> | 47 <sup>1</sup> / <sub>2</sub> | 49 <sup>1</sup> / <sub>2</sub> | 53 <sup>3</sup> / <sub>8</sub> |
| 46             | 46                             | 47                             | 49                             | 50 <sup>3</sup> / <sub>4</sub> | 46             | 45 <sup>3</sup> / <sub>4</sub> | 47 <sup>3</sup> / <sub>4</sub> | 49 <sup>3</sup> / <sub>4</sub> | 52 <sup>1</sup> / <sub>4</sub> | 46             | 48                             | 50                             | 52                             | 56 <sup>1</sup> / <sub>2</sub> |
| 48             | 47 <sup>1</sup> / <sub>2</sub> | 49                             | 51                             | 53                             | 48             | 48                             | 50                             | 52                             | 54 <sup>3</sup> / <sub>4</sub> | 48             | 50                             | 52                             | 54                             | 58 <sup>1</sup> / <sub>2</sub> |
| 50             | 49 <sup>1</sup> / <sub>2</sub> | 51                             | 53                             | 55 <sup>1</sup> / <sub>4</sub> | 50             | 50                             | 52                             | 54                             | 57                             | 50             | -                              | -                              | -                              | -                              |
| 52             | 51 <sup>1</sup> / <sub>2</sub> | 53                             | 55                             | 57 <sup>1</sup> / <sub>4</sub> | 52             | 52                             | 54                             | 56                             | 59                             | 52             | -                              | -                              | -                              | -                              |
| 54             | 53 <sup>1</sup> / <sub>4</sub> | 55 <sup>1</sup> / <sub>4</sub> | 57 <sup>1</sup> / <sub>4</sub> | 59 <sup>3</sup> / <sub>4</sub> | 54             | 54 <sup>1</sup> / <sub>4</sub> | 56 <sup>1</sup> / <sub>4</sub> | 58 <sup>1</sup> / <sub>4</sub> | 61 <sup>1</sup> / <sub>4</sub> | 54             | -                              | -                              | -                              | -                              |
| 56             | 55 <sup>1</sup> / <sub>4</sub> | 57 <sup>1</sup> / <sub>4</sub> | 59 <sup>1</sup> / <sub>4</sub> | 61 <sup>3</sup> / <sub>4</sub> | 56             | 56 <sup>1</sup> / <sub>4</sub> | 58 <sup>1</sup> / <sub>4</sub> | 60 <sup>1</sup> / <sub>4</sub> | 63 <sup>1</sup> / <sub>2</sub> | 56             | -                              | -                              | -                              | -                              |
| 58             | 57 <sup>1</sup> / <sub>4</sub> | 59 <sup>1</sup> / <sub>4</sub> | 61 <sup>1</sup> / <sub>4</sub> | 63 <sup>3</sup> / <sub>4</sub> | 58             | 58                             | 60 <sup>1</sup> / <sub>2</sub> | 62 <sup>1</sup> / <sub>2</sub> | 65 <sup>1</sup> / <sub>2</sub> | 58             | -                              | -                              | -                              | -                              |
| 60             | 59 <sup>3</sup> / <sub>4</sub> | 61 <sup>3</sup> / <sub>4</sub> | 63 <sup>3</sup> / <sub>4</sub> | 66 <sup>1</sup> / <sub>4</sub> | 60             | 60 <sup>1</sup> / <sub>4</sub> | 62 <sup>3</sup> / <sub>4</sub> | 64 <sup>3</sup> / <sub>4</sub> | 68 <sup>1</sup> / <sub>4</sub> | 60             | -                              | -                              | -                              | -                              |

DIMENSIONS IN INCHES.

NOTE: There are no class 900 flanges NPS 50 and larger.

\*Inner rings are mandatory for class 900 flanges, NPS 26 to 48.

For ASME B16.47 Series A flanges NPS 12 to 24 use gasket dimensions listed on page 10, for ASME B 16.5 flanges.

The above style CG gasket dimensions are also suitable for NPS 26 to 36 class 400 and 600 BS 3293 flanges.

# STYLE CG & CGI TO SUIT LARGE DIAMETER FLANGES CLASS 75-125

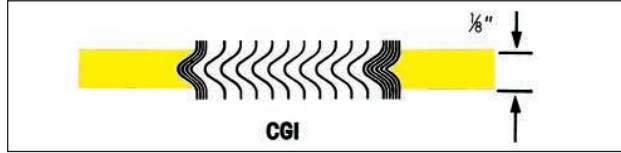
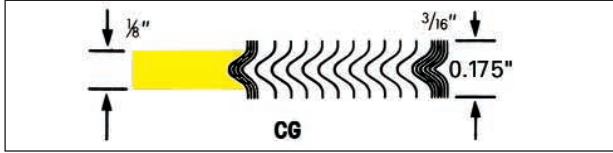

TABLE 8

| CLASS 75 - SLIP-ON AND BLIND† |                                |                                |                                | CLASS 75 - WELD-NECK AND BLIND† |                                |                                |                                | CLASS 125      |                                |                                 |                                 |
|-------------------------------|--------------------------------|--------------------------------|--------------------------------|---------------------------------|--------------------------------|--------------------------------|--------------------------------|----------------|--------------------------------|---------------------------------|---------------------------------|
| Nom. Pipe Size                | Sealing Element                |                                | Centering Ring Outside Dia.    | Nom. Pipe Size                  | Sealing Element                |                                | Centering Ring Outside Dia.    | Nom. Pipe Size | Sealing Element                |                                 | Centering Ring Outside Dia.     |
|                               | Inside Dia.                    | Outside Dia.                   |                                |                                 | Inside Dia.                    | Outside Dia.                   |                                |                | Inside Dia.                    | Outside Dia.                    |                                 |
| 26                            | 27                             | 28 <sup>1</sup> / <sub>4</sub> | 30 <sup>1</sup> / <sub>8</sub> | 26                              | 26 <sup>1</sup> / <sub>2</sub> | 27 <sup>3</sup> / <sub>4</sub> | 28 <sup>3</sup> / <sub>4</sub> | 26             | 26 <sup>1</sup> / <sub>2</sub> | 27 <sup>3</sup> / <sub>4</sub>  | 30 <sup>1</sup> / <sub>2</sub>  |
| 28                            | 29                             | 30 <sup>1</sup> / <sub>4</sub> | 32 <sup>1</sup> / <sub>8</sub> | 28                              | 28 <sup>1</sup> / <sub>2</sub> | 29 <sup>3</sup> / <sub>4</sub> | 30 <sup>3</sup> / <sub>4</sub> | 28             | 28 <sup>1</sup> / <sub>2</sub> | 29 <sup>3</sup> / <sub>4</sub>  | 32 <sup>3</sup> / <sub>4</sub>  |
| 30                            | 31                             | 32 <sup>1</sup> / <sub>4</sub> | 34 <sup>1</sup> / <sub>8</sub> | 30                              | 30 <sup>1</sup> / <sub>2</sub> | 31 <sup>3</sup> / <sub>4</sub> | 32 <sup>3</sup> / <sub>4</sub> | 30             | 30 <sup>1</sup> / <sub>2</sub> | 31 <sup>3</sup> / <sub>4</sub>  | 34 <sup>3</sup> / <sub>4</sub>  |
| 32                            | 33 <sup>3</sup> / <sub>8</sub> | 34 <sup>3</sup> / <sub>8</sub> | 36 <sup>3</sup> / <sub>8</sub> | 32                              | 32 <sup>1</sup> / <sub>2</sub> | 33 <sup>3</sup> / <sub>4</sub> | 35 <sup>1</sup> / <sub>8</sub> | 32             | 32 <sup>1</sup> / <sub>2</sub> | 33 <sup>3</sup> / <sub>8</sub>  | 37                              |
| 34                            | 35 <sup>1</sup> / <sub>8</sub> | 36 <sup>1</sup> / <sub>2</sub> | 38 <sup>3</sup> / <sub>8</sub> | 34                              | 34 <sup>1</sup> / <sub>2</sub> | 35 <sup>7</sup> / <sub>8</sub> | 37 <sup>1</sup> / <sub>8</sub> | 34             | 34 <sup>1</sup> / <sub>2</sub> | 35 <sup>5</sup> / <sub>8</sub>  | 39                              |
| 36                            | 37 <sup>1</sup> / <sub>8</sub> | 38 <sup>1</sup> / <sub>2</sub> | 40 <sup>3</sup> / <sub>8</sub> | 36                              | 36 <sup>1</sup> / <sub>2</sub> | 37 <sup>7</sup> / <sub>8</sub> | 39 <sup>1</sup> / <sub>8</sub> | 36             | 36 <sup>1</sup> / <sub>2</sub> | 38 <sup>1</sup> / <sub>8</sub>  | 41 <sup>1</sup> / <sub>4</sub>  |
| 38                            | -                              | -                              | -                              | 38                              | -                              | -                              | -                              | 38             | 38 <sup>1</sup> / <sub>2</sub> | 40 <sup>1</sup> / <sub>8</sub>  | 43 <sup>3</sup> / <sub>4</sub>  |
| 40                            | -                              | -                              | -                              | 40                              | -                              | -                              | -                              | 40             | 40 <sup>1</sup> / <sub>2</sub> | 42 <sup>1</sup> / <sub>8</sub>  | 45 <sup>3</sup> / <sub>4</sub>  |
| 42                            | 43 <sup>1</sup> / <sub>4</sub> | 44 <sup>3</sup> / <sub>4</sub> | 46 <sup>5</sup> / <sub>8</sub> | 42                              | 42 <sup>1</sup> / <sub>2</sub> | 44                             | 45 <sup>5</sup> / <sub>8</sub> | 42             | 42 <sup>1</sup> / <sub>2</sub> | 44 <sup>1</sup> / <sub>4</sub>  | 48                              |
| 44                            | -                              | -                              | -                              | 44                              | -                              | -                              | -                              | 44             | 44 <sup>1</sup> / <sub>2</sub> | 46 <sup>3</sup> / <sub>8</sub>  | 50 <sup>1</sup> / <sub>4</sub>  |
| 46                            | -                              | -                              | -                              | 46                              | -                              | -                              | -                              | 46             | 46 <sup>1</sup> / <sub>2</sub> | 48 <sup>3</sup> / <sub>8</sub>  | 52 <sup>1</sup> / <sub>4</sub>  |
| 48                            | 49 <sup>1</sup> / <sub>4</sub> | 50 <sup>1</sup> / <sub>8</sub> | 52 <sup>5</sup> / <sub>8</sub> | 48                              | 48 <sup>1</sup> / <sub>2</sub> | 50 <sup>1</sup> / <sub>8</sub> | 51 <sup>5</sup> / <sub>8</sub> | 48             | 48 <sup>1</sup> / <sub>2</sub> | 50 <sup>3</sup> / <sub>8</sub>  | 54 <sup>1</sup> / <sub>2</sub>  |
| 50                            | -                              | -                              | -                              | 50                              | -                              | -                              | -                              | 50             | 50 <sup>1</sup> / <sub>2</sub> | 52 <sup>1</sup> / <sub>2</sub>  | 56 <sup>1</sup> / <sub>2</sub>  |
| 52                            | -                              | -                              | -                              | 52                              | -                              | -                              | -                              | 52             | 52 <sup>1</sup> / <sub>2</sub> | 54 <sup>1</sup> / <sub>2</sub>  | 58 <sup>3</sup> / <sub>4</sub>  |
| 54                            | 55 <sup>3</sup> / <sub>8</sub> | 57 <sup>3</sup> / <sub>4</sub> | 59 <sup>1</sup> / <sub>8</sub> | 54                              | 54 <sup>1</sup> / <sub>2</sub> | 56 <sup>3</sup> / <sub>8</sub> | 57 <sup>1</sup> / <sub>8</sub> | 54             | 54 <sup>1</sup> / <sub>4</sub> | 56 <sup>1</sup> / <sub>2</sub>  | 61                              |
| 60                            | 61 <sup>3</sup> / <sub>8</sub> | 63 <sup>3</sup> / <sub>8</sub> | 65 <sup>1</sup> / <sub>8</sub> | 60                              | 60 <sup>1</sup> / <sub>2</sub> | 62 <sup>1</sup> / <sub>2</sub> | 63 <sup>1</sup> / <sub>8</sub> | 60             | 60 <sup>1</sup> / <sub>2</sub> | 62 <sup>1</sup> / <sub>2</sub>  | 67 <sup>1</sup> / <sub>2</sub>  |
| 66                            | 67 <sup>1</sup> / <sub>2</sub> | 69 <sup>1</sup> / <sub>2</sub> | 71 <sup>3</sup> / <sub>4</sub> | 66                              | 66 <sup>1</sup> / <sub>2</sub> | 68 <sup>1</sup> / <sub>2</sub> | 70 <sup>1</sup> / <sub>4</sub> | 66             | 71                             | 72 <sup>3</sup> / <sub>4</sub>  | 74 <sup>1</sup> / <sub>4</sub>  |
| 72                            | 73 <sup>1</sup> / <sub>2</sub> | 75 <sup>1</sup> / <sub>2</sub> | 77 <sup>3</sup> / <sub>4</sub> | 72                              | 72 <sup>1</sup> / <sub>2</sub> | 74 <sup>1</sup> / <sub>2</sub> | 76 <sup>1</sup> / <sub>4</sub> | 72             | 77 <sup>1</sup> / <sub>2</sub> | 79 <sup>1</sup> / <sub>4</sub>  | 80 <sup>3</sup> / <sub>4</sub>  |
| 84                            | -                              | -                              | -                              | 84                              | -                              | -                              | -                              | 84             | 90 <sup>1</sup> / <sub>4</sub> | 92                              | 93 <sup>1</sup> / <sub>2</sub>  |
| 96                            | -                              | -                              | -                              | 96                              | -                              | -                              | -                              | 96             | 103                            | 104 <sup>3</sup> / <sub>4</sub> | 106 <sup>1</sup> / <sub>4</sub> |

DIMENSIONS IN INCHES.

GASKET THICKNESS. TO ENSURE GREATER GASKET STABILITY; FOR LARGER DIAMETER ABOVE 39" (1000 mm) WE RECOMMEND 7.2 mm (0.285 in) THICK GASKETS WITH 5.0 mm (0.197 in) THICK GUIDE RINGS, OR 6.4 mm (0.250 in) THICK GASKETS WITH 4.8 mm (0.188 in) THICK GUIDE RINGS.

†OUTSIDE DIAMETER, FACING DIAMETER AND DRILLING OF CLASS 75 BLIND FLANGES DEPEND ON WHETHER THEY ARE TO BE USED AGAINST WELD-NECK OR SLIP-ON FLANGES.

\*WHERE STYLE CGI GASKETS ARE REQUIRED, INNER RING I.D. MUST BE SPECIFIED. STANDARD PRACTICE IS TO USE INNER RINGS WITH AN I.D. THAT IS 3.2 mm (0.125 in.) GREATER THAN THE FLANGE BORE.

# STYLE CG & CGI

## TO SUIT LARGE DIAMETER FLANGES

### CLASS 175-350

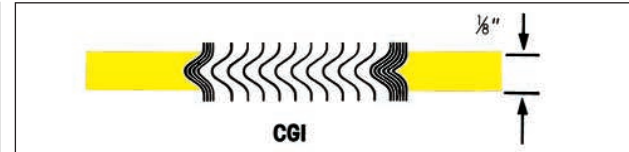
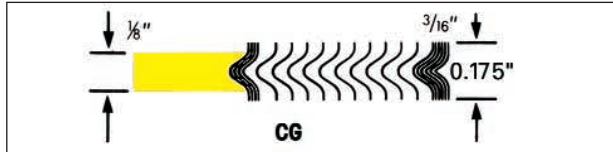

TABLE 8.1

| Nom. Pipe Size | Sealing Element |              | Centering Ring Outside Dia. |
|----------------|-----------------|--------------|-----------------------------|
|                | Inside Dia.     | Outside Dia. |                             |
| 26             | 26½             | 27¾          | 29⅛                         |
| 28             | 28½             | 29¾          | 31⅞                         |
| 30             | 30½             | 31¾          | 33⅞                         |
| 32             | 32½             | 33¾          | 35⅞                         |
| 34             | 34½             | 35⅞          | 37½                         |
| 36             | 36½             | 37⅞          | 39½                         |
| 38             | 38½             | 39⅞          | 41½                         |
| 40             | 40½             | 42           | 43½                         |
| 42             | 42½             | 44           | 45⅞                         |
| 44             | 44½             | 46           | 47⅞                         |
| 46             | 46½             | 48           | 49⅞                         |
| 48             | 48½             | 50⅞          | 51⅞                         |
| 50             | 50½             | 52¼          | 53⅞                         |
| 52             | 52½             | 54⅞          | 56⅞                         |
| 54             | 54½             | 56⅞          | 58⅞                         |
| 60             | 60½             | 62½          | 64⅞                         |
| 66             | 67⅞             | 68⅞          | 70⅞                         |
| 72             | 73⅞             | 75⅞          | 76⅞                         |
| 84             | 87              | 88¾          | 90¼                         |
| 96             | 99              | 100¾         | 102¼                        |

| Nom. Pipe Size | Sealing Element |              | Centering Ring Outside Dia. |
|----------------|-----------------|--------------|-----------------------------|
|                | Inside Dia.     | Outside Dia. |                             |
| 26             | 26½             | 27¾          | 32¾                         |
| 28             | 28½             | 29¾          | 35¼                         |
| 30             | 30½             | 31¾          | 37½                         |
| 32             | 32½             | 33⅞          | 39¾                         |
| 34             | 34½             | 35⅞          | 41¾                         |
| 36             | 36½             | 38⅞          | 44                          |
| 38             | 38½             | 40⅞          | 46                          |
| 40             | 40½             | 42⅞          | 48¼                         |
| 42             | 42½             | 44¼          | 50¼                         |
| 44             | 44½             | 46⅞          | 53                          |
| 46             | 46½             | 48⅞          | 55¼                         |
| 48             | 48½             | 50⅞          | 58¼                         |
| 50             | -               | -            | -                           |
| 52             | -               | -            | -                           |
| 54             | -               | -            | -                           |
| 60             | -               | -            | -                           |
| 66             | -               | -            | -                           |
| 72             | -               | -            | -                           |
| 84             | -               | -            | -                           |
| 96             | -               | -            | -                           |

| Nom. Pipe Size | Sealing Element |              | Centering Ring Outside Dia. |
|----------------|-----------------|--------------|-----------------------------|
|                | Inside Dia.     | Outside Dia. |                             |
| 26             | 26½             | 27¾          | 29⅞                         |
| 28             | 28½             | 29¾          | 31⅞                         |
| 30             | 30½             | 31¾          | 33⅞                         |
| 32             | 32½             | 33⅞          | 35⅞                         |
| 34             | 34½             | 35⅞          | 37⅞                         |
| 36             | 36½             | 38⅞          | 40⅞                         |
| 38             | 38½             | 40⅞          | 42⅞                         |
| 40             | 40½             | 42⅞          | 44⅞                         |
| 42             | 42½             | 44¼          | 46⅞                         |
| 44             | 44½             | 46⅞          | 49                          |
| 46             | 46½             | 48⅞          | 51                          |
| 48             | 48½             | 50⅞          | 53                          |
| 50             | -               | -            | -                           |
| 52             | 52½             | 54¼          | 57⅞                         |
| 54             | 54½             | 56½          | 59⅞                         |
| 60             | 60½             | 62½          | 65⅞                         |
| 66             | 66½             | 68½          | 72½                         |
| 72             | 75¼             | 77           | 78½                         |
| 84             | 88⅞             | 90⅞          | 91⅞                         |
| 96             | 103¾            | 102½         | 104                         |

DIMENSIONS IN INCHES.

# STYLE CG & CGI TO BS3381 TO SUIT BS1560 & ASME B16.5 FLANGES

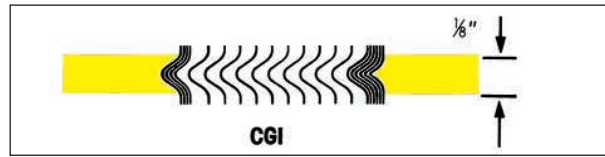
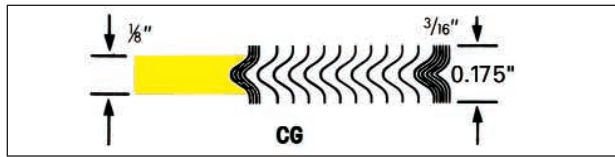

TABLE 9

| Nominal Pipe Size | INNER RING | CLASS 150       |             |                | CLASS 300 to 1500 |             | CLASS 300      | CLASS 400        | CLASS 600 | CLASS 900 | CLASS 1500 | CLASS 2500      |             |                |
|-------------------|------------|-----------------|-------------|----------------|-------------------|-------------|----------------|------------------|-----------|-----------|------------|-----------------|-------------|----------------|
|                   |            | SEALING ELEMENT |             | CENTERING RING | SEALING ELEMENT   |             | CENTERING RING |                  |           |           |            | SEALING ELEMENT |             | CENTERING RING |
|                   |            | INSIDE DIA.     | INSIDE DIA. | OUTSIDE DIA.   | OUTSIDE DIA.      | INSIDE DIA. | OUTSIDE DIA.   | OUTSIDE DIAMETER |           |           |            |                 | INSIDE DIA. | OUTSIDE DIA.   |
| 1/4               | -          | 1/2*            | 7/8         | 1 3/4          | 1/2*              | 7/8         | 1 3/4          | 1 3/4            | 1 3/4     | -         | -          | -               | -           | -              |
| 1/2               | 9/16       | 3/4*            | 1 1/4       | 1 7/8          | 3/4*              | 1 1/4       | 2 1/8          | 2 1/8            | 2 1/8     | 2 1/2     | 2 1/2      | 3/4             | 1 1/4       | 2 3/4          |
| 3/4               | 1 1/16     | 1 1/16*         | 1 9/16      | 2 1/4          | 1*                | 1 9/16      | 2 5/8          | 2 5/8            | 2 5/8     | 2 3/4     | 2 3/4      | 1               | 1 9/16      | 3              |
| 1                 | 1 1/16     | 1 5/16*         | 1 7/8       | 2 5/8          | 1 1/4             | 1 7/8       | 2 7/8          | 2 7/8            | 2 7/8     | 3 3/8     | 3 3/8      | 1 1/4           | 1 7/8       | 3 3/8          |
| 1 1/4             | 1 3/8      | 1 13/16*        | 2 3/8       | 3              | 1 3/4             | 2 3/8       | 3 1/4          | 3 1/4            | 3 1/4     | 3 1/2     | 3 1/2      | 1 9/16          | 2 3/8       | 4 1/8          |
| 1 1/2             | 1 5/8      | 2 1/8           | 2 3/4       | 3 3/8          | 2*                | 2 3/4       | 3 3/4          | 3 3/4            | 3 3/4     | 3 7/8     | 3 7/8      | 1 7/8           | 2 3/4       | 4 5/8          |
| 2                 | 2 1/16     | 2 3/4           | 3 3/8       | 4 1/8          | 2 5/8             | 3 3/8       | 4 3/8          | 4 3/8            | 4 3/8     | 5 5/8     | 5 5/8      | 2 5/16          | 3 3/8       | 5 3/4          |
| 2 1/2             | 2 1/2      | 3 1/4           | 3 7/8       | 4 7/8          | 3 1/8             | 3 7/8       | 5 1/8          | 5 1/8            | 5 1/8     | 6 1/2     | 6 1/2      | 2 3/4           | 3 7/8       | 6 5/8          |
| 3                 | 3 1/16     | 4               | 4 3/4       | 5 3/8          | 3 3/4             | 4 3/4       | 5 7/8          | 5 7/8            | 5 7/8     | 6 5/8     | 6 7/8      | 3 5/8           | 4 3/4       | 7 3/4          |
| 3 1/2             | 3 9/16     | 4 1/2           | 5 1/4       | 6 3/8          | 4 1/4             | 5 1/4       | 6 1/2          | 6 3/8            | 6 3/8     | -         | -          | -               | -           | -              |
| 4                 | 4 1/16     | 5               | 5 7/8       | 6 7/8          | 4 3/4             | 5 7/8       | 7 1/8          | 7                | 7 5/8     | 8 3/8     | 8 1/4      | 4 3/4           | 5 7/8       | 9 1/4          |
| 4 1/2             | 4 9/16     | 5 9/16          | 6 1/2       | 7              | 5 5/16            | 6 1/2       | 7 3/4          | -                | -         | -         | -          | -               | -           | -              |
| 5                 | 5 1/16     | 6 1/16          | 7           | 7 3/4          | 5 13/16           | 7           | 8 1/2          | 8 3/8            | 9 1/2     | 9 3/4     | 10         | 5 13/16         | 7           | 11             |
| 6                 | 6 1/16     | 7 1/8           | 8 1/4       | 8 3/4          | 6 7/8             | 8 1/4       | 9 7/8          | 9 3/4            | 10 1/2    | 11 3/8    | 11 1/8     | 6 7/8           | 8 1/4       | 12 1/2         |
| 8                 | 8          | 9 1/8           | 10 3/8      | 11             | 8 7/8             | 10 3/8      | 12 1/8         | 12               | 12 5/8    | 14 1/8    | 13 7/8     | 8 7/8           | 10 3/8      | 15 1/4         |
| 10                | 10         | 11 5/16         | 12 1/2      | 13 3/8         | 11 1/16           | 12 1/2      | 14 1/4         | 14 7/8           | 15 3/4    | 17 1/8    | 17 1/8     | 11 1/16         | 12 1/2      | 18 3/4         |
| 12                | 11 15/16   | 13 3/8          | 14 3/4      | 16 1/8         | 13 3/8            | 14 3/4      | 16 5/8         | 16 1/2           | 18        | 19 5/8    | 20 1/2     | 13 3/8          | 14 3/4      | 21 5/8         |
| 14                | 13 1/2     | 14 5/8          | 16          | 17 3/4         | 14 3/8            | 16          | 19 1/8         | 19               | 19 3/8    | 20 1/2    | 22 3/4     | -               | -           | -              |
| 16                | 15 1/2     | 16 5/8          | 18 1/4      | 20 1/4         | 16 3/8            | 18 1/4      | 21 1/4         | 21 1/8           | 22 1/4    | 22 5/8    | 25 1/4     | -               | -           | -              |
| 18                | 17 1/2     | 18 3/4          | 20 3/4      | 21 5/8         | 18 1/2            | 20 3/4      | 23 1/2         | 23 3/8           | 24 7/8    | 25 1/8    | 27 3/4     | -               | -           | -              |
| 20                | 19 1/2     | 20 3/4          | 22 3/4      | 23 7/8         | 20 1/2            | 22 3/4      | 25 3/4         | 25 1/2           | 26 7/8    | 27 1/2    | 29 3/4     | -               | -           | -              |
| 24                | 23 1/2     | 24 7/8          | 27          | 28 1/4         | 24 5/8            | 27          | 30 1/2         | 30 1/4           | 31 1/8    | 33        | 35 1/2     | -               | -           | -              |

DIMENSIONS IN INCHES.

\*These gasket dimensions are not suitable for use with threaded or slip on flanges.  
See Table 4 for special sizes.

In accordance with BS 3381 all class 900, 1500 and 2500 gaskets and all gaskets containing PTFE filler material shall have an inner ring.

# STYLE CG & CGI TO BS3381 TO SUIT BS1560 & ASME B16.5 FLANGES

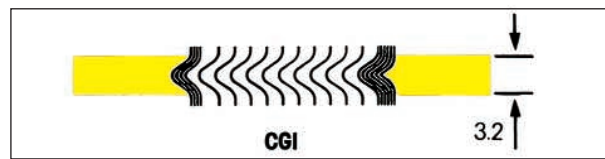
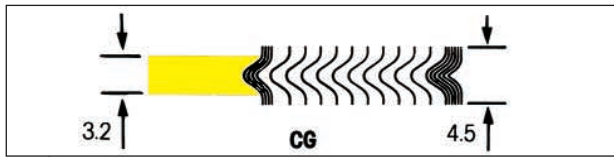

TABLE 10

| Nominal Pipe Size | INNER RING | CLASS 150       |             |                | CLASS 300 to 1500 |             | CLASS 300      | CLASS 400        | CLASS 600 | CLASS 900 | CLASS 1500 | CLASS 2500      |             |                |
|-------------------|------------|-----------------|-------------|----------------|-------------------|-------------|----------------|------------------|-----------|-----------|------------|-----------------|-------------|----------------|
|                   |            | SEALING ELEMENT |             | CENTERING RING | SEALING ELEMENT   |             | CENTERING RING |                  |           |           |            | SEALING ELEMENT |             | CENTERING RING |
|                   |            | INSIDE DIA.     | INSIDE DIA. | OUTSIDE DIA.   | OUTSIDE DIA.      | INSIDE DIA. | OUTSIDE DIA.   | OUTSIDE DIAMETER |           |           |            |                 | INSIDE DIA. | OUTSIDE DIA.   |
| 1/4               | -          | 12.7*           | 22.2        | 44.5           | 12.7*             | 22.2        | 44.5           | 44.5             | 44.5      | -         | -          | -               | -           | -              |
| 1/2               | 14.3       | 19.1*           | 31.8        | 47.6           | 19.1*             | 31.8        | 54.0           | 54.0             | 54.0      | 63.5      | 63.5       | 19.1            | 31.8        | 69.9           |
| 3/4               | 20.6       | 27.0*           | 39.7        | 57.2           | 25.4*             | 39.7        | 66.7           | 66.7             | 66.7      | 69.9      | 69.9       | 25.4            | 39.7        | 76.2           |
| 1                 | 27.0       | 33.3*           | 47.6        | 66.7           | 31.8*             | 47.6        | 73.0           | 73.0             | 73.0      | 79.4      | 79.4       | 31.8            | 47.6        | 85.7           |
| 1 1/4             | 34.9       | 46.0*           | 60.3        | 76.2           | 44.5*             | 60.3        | 82.6           | 82.6             | 82.6      | 88.9      | 88.9       | 39.7            | 60.3        | 104.8          |
| 1 1/2             | 41.3       | 54.0            | 69.9        | 85.7           | 50.8*             | 69.9        | 95.3           | 95.3             | 95.3      | 98.4      | 98.4       | 47.6            | 69.9        | 117.5          |
| 2                 | 52.4       | 69.9            | 85.7        | 104.8          | 66.7              | 85.7        | 111.1          | 111.1            | 111.1     | 142.9     | 142.9      | 58.7            | 85.7        | 146.1          |
| 2 1/2             | 63.5       | 82.6            | 98.4        | 123.8          | 79.4              | 98.4        | 130.2          | 130.2            | 130.2     | 165.1     | 165.1      | 69.9            | 98.4        | 168.3          |
| 3                 | 77.8       | 101.6           | 120.7       | 136.5          | 95.3              | 120.7       | 149.2          | 149.2            | 149.2     | 168.3     | 174.6      | 92.1            | 120.7       | 196.9          |
| 3 1/2             | 90.5       | 114.3           | 133.4       | 161.9          | 108.0             | 133.4       | 165.1          | 161.9            | 161.9     | -         | -          | -               | -           | -              |
| 4                 | 103.2      | 127.0           | 149.2       | 174.6          | 120.7             | 149.2       | 181.0          | 177.8            | 193.7     | 206.4     | 209.6      | 120.7           | 149.2       | 235.0          |
| 4                 | 115.9      | 141.3           | 165.1       | 177.8          | 134.9             | 165.1       | 196.9          | -                | -         | -         | -          | -               | -           | -              |
| 5                 | 128.6      | 154.0           | 177.8       | 196.9          | 147.6             | 177.8       | 215.9          | 212.7            | 241.3     | 247.7     | 254.0      | 147.6           | 177.8       | 279.4          |
| 6                 | 154.0      | 181.0           | 209.6       | 222.3          | 174.6             | 209.6       | 250.8          | 247.7            | 266.7     | 288.9     | 282.6      | 174.6           | 209.6       | 317.5          |
| 8                 | 203.2      | 231.8           | 263.5       | 279.4          | 225.4             | 263.5       | 308.0          | 304.8            | 320.7     | 358.8     | 352.4      | 225.4           | 263.5       | 387.4          |
| 10                | 254.0      | 287.3           | 317.5       | 339.7          | 281.0             | 317.5       | 362.0          | 358.8            | 400.1     | 435.0     | 435.0      | 281.0           | 317.5       | 476.3          |
| 12                | 303.2      | 339.7           | 374.7       | 409.6          | 333.4             | 374.7       | 422.3          | 419.1            | 457.2     | 498.5     | 520.7      | 333.4           | 374.7       | 549.3          |
| 14                | 342.9      | 371.5           | 406.4       | 450.9          | 365.1             | 406.4       | 485.8          | 482.6            | 492.1     | 520.7     | 577.9      | -               | -           | -              |
| 16                | 393.7      | 422.3           | 463.6       | 514.4          | 415.9             | 463.6       | 539.8          | 536.6            | 565.2     | 574.7     | 641.4      | -               | -           | -              |
| 18                | 444.5      | 476.3           | 527.1       | 549.3          | 469.9             | 527.1       | 596.9          | 593.7            | 612.8     | 638.2     | 704.9      | -               | -           | -              |
| 20                | 495.3      | 527.1           | 577.9       | 606.4          | 520.7             | 577.9       | 654.1          | 647.7            | 682.6     | 698.5     | 755.7      | -               | -           | -              |
| 24                | 596.9      | 631.8           | 685.8       | 717.6          | 625.5             | 685.8       | 774.7          | 768.4            | 790.6     | 838.2     | 901.7      | -               | -           | -              |

DIMENSIONS IN mm.

\*These gasket dimensions are not suitable for use with threaded or slip on flanges.  
See Table 4 for special sizes.

In accordance with BS 3381 all class 900, 1500 and 2500 gaskets and all gaskets containing PTFE filler material shall have an inner ring.

# STYLE CG & CGI TO SUIT BS10 FLANGES

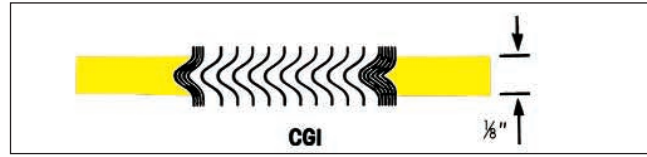
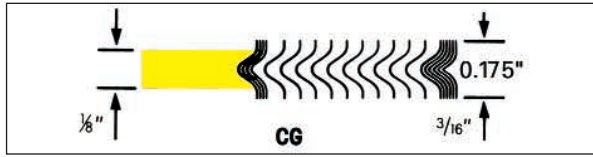

TABLE  
11

| Nominal Pipe Size | TABLE D-R  | TABLE D & E     |         | TABLE D        | TABLE E | TABLE F to R    |         | TABLE F          | TABLE H | TABLE J | TABLE K | TABLE R | TABLE S         |                |                 | TABLE T        |        |        |
|-------------------|------------|-----------------|---------|----------------|---------|-----------------|---------|------------------|---------|---------|---------|---------|-----------------|----------------|-----------------|----------------|--------|--------|
|                   | INNER RING | SEALING ELEMENT |         | CENTERING RING |         | SEALING ELEMENT |         | CENTERING RING   |         |         |         |         | SEALING ELEMENT | CENTERING RING | SEALING ELEMENT | CENTERING RING |        |        |
|                   | ID         | ID              | OD      | OD             | OD      | ID              | OD      | OUTSIDE DIAMETER |         |         |         |         | ID              | OD             | OD              | ID             | OD     | OD     |
| 1/2               | 9/16       | 1 1/32          | 1 15/32 | 2 1/8          | 2 1/8   | 1 1/32          | 1 17/32 | 2 1/8            | 2 5/8   | 2 5/8   | 2 5/8   | 2 5/8   | 3/4             | 1 1/4          | 2 3/4           | 3/4            | 1 1/4  | 3 1/4  |
| 3/4               | 1 3/16     | 1 1/4           | 1 11/16 | 2 3/8          | 2 3/8   | 1 1/4           | 1 3/4   | 2 3/8            | 2 5/8   | 2 5/8   | 2 5/8   | 2 5/8   | 1               | 1 1/16         | 2 3/4           | 1              | 1 1/16 | 3 1/4  |
| 1                 | 1 1/16     | 1 1/16          | 2 1/16  | 2 3/4          | 2 3/4   | 1 9/16          | 2 3/16  | 2 13/16          | 2 13/16 | 2 13/16 | 3 1/8   | 3 3/8   | 1 1/4           | 1 7/8          | 3 1/4           | 1 1/4          | 1 7/8  | 3 1/2  |
| 1 1/4             | 1 5/16     | 1 7/8           | 2 3/8   | 2 15/16        | 2 15/16 | 1 7/8           | 2 1/2   | 3 1/4            | 3 1/4   | 3 1/4   | 3 1/4   | 3 1/4   | 1 1/2           | 2 3/16         | 3 1/2           | 1 5/8          | 2 5/16 | 3 3/8  |
| 1 1/2             | 1 1/16     | 2 1/8           | 2 5/8   | 3 3/8          | 3 3/8   | 2 1/8           | 2 3/4   | 3 1/2            | 3 1/2   | 3 1/2   | 3 3/4   | 3 3/4   | 1 3/4           | 2 1/2          | 4               | 1 7/8          | 2 5/8  | 4 1/2  |
| 2                 | 2 1/16     | 2 5/8           | 3 3/8   | 3 7/8          | 3 7/8   | 2 5/8           | 3 1/4   | 4 3/8            | 4 3/8   | 4 1/4   | 4 3/8   | 4 3/8   | 2 1/4           | 3 3/8          | 4 1/2           | 2 3/8          | 3 1/4  | 5      |
| 2 1/2             | 2 9/16     | 3 1/4           | 3 7/8   | 4 3/8          | 4 3/8   | 3 1/4           | 4       | 5 1/8            | 5 1/8   | 5       | 5       | 5       | 2 7/8           | 3 3/4          | 5               | 3              | 3 7/8  | 5 5/8  |
| 3                 | 3 1/16     | 3 13/16         | 4 7/16  | 5 1/8          | 5 1/8   | 3 13/16         | 4 9/16  | 5 7/8            | 5 7/8   | 5 3/4   | 5 3/4   | 5 3/4   | 3 3/8           | 4 1/4          | 5 5/8           | 3 1/2          | 4 1/2  | 6 1/2  |
| 3 1/2             | 3 9/16     | 4 5/16          | 4 15/16 | 5 7/8          | 5 7/8   | 4 5/16          | 5 1/16  | 6 3/8            | 6 3/8   | 6 1/4   | 6 3/8   | 6 3/8   | 3 7/8           | 4 3/4          | 6 3/8           | 4              | 5 1/8  | 7 3/8  |
| 4                 | 4 1/16     | 4 7/8           | 5 1/2   | 6 3/8          | 6 3/8   | 4 7/8           | 5 5/8   | 6 7/8            | 6 7/8   | 6 3/4   | 6 7/8   | 6 7/8   | 4 3/8           | 5 3/8          | 7               | 4 1/2          | 5 5/8  | 8 1/8  |
| 4 1/2             | 4 9/16     | 5 3/8           | 6       | 6 7/8          | 6 7/8   | 5 3/8           | 6 1/4   | 7 1/2            | 7 1/2   | 7 3/8   | 7 3/8   | 7 3/8   | 4 7/8           | 5 7/8          | 7 1/2           | 5              | 6 1/4  | 9      |
| 5                 | 5 1/16     | 5 7/8           | 6 1/2   | 7 5/8          | 7 5/8   | 5 7/8           | 6 3/4   | 8 1/2            | 8 1/2   | 8 3/8   | 8 3/8   | 8 3/8   | 5 3/8           | 6 3/8          | 8 3/8           | 5 1/2          | 6 3/4  | 9 5/8  |
| 6                 | 6 1/16     | 6 7/8           | 7 1/2   | 8 5/8          | 8 1/2   | 6 7/8           | 7 3/4   | 9 1/2            | 9 1/2   | 9 3/8   | 9 3/8   | 9 3/8   | 6 3/8           | 7 3/8          | 9 3/4           | 6 1/2          | 7 3/4  | 11 1/4 |
| 7                 | 7 1/16     | 7 7/8           | 8 5/8   | 9 5/8          | 9 1/2   | 7 7/8           | 8 7/8   | 10 3/4           | 10 3/4  | 10 5/8  | 10 1/2  | 10 1/2  | 7 3/8           | 8 5/8          | 11 3/8          | 7 1/2          | 9      | 13 3/8 |
| 8                 | 8 1/16     | 8 7/8           | 9 5/8   | 10 7/8         | 10 3/4  | 8 7/8           | 9 7/8   | 12               | 12      | 11 7/8  | 11 1/2  | 11 3/4  | 8 3/8           | 9 5/8          | 12 3/4          | 8 1/2          | 10     | 14 1/2 |
| 9                 | 9 1/16     | 9 7/8           | 10 5/8  | 12 1/8         | 12      | 9 7/8           | 10 7/8  | 13 3/8           | 13 3/8  | 13      | 13      | 13      | 9 1/2           | 10 3/4         | 14 1/8          | 9 5/8          | 11 1/4 | 16 1/8 |
| 10                | 10 1/16    | 10 7/8          | 11 5/8  | 13 1/4         | 13 1/4  | 11              | 12      | 14 1/8           | 14 1/8  | 14      | 14      | 14 1/4  | 10 1/2          | 11 7/8         | 15 1/2          | 10 5/8         | 12 1/4 | 17 3/4 |
| 11                | 11 1/16    | 11 7/8          | 12 5/8  | 14 1/4         | 14 1/4  | 12              | 13      | 15 1/8           | 15 1/8  | 15      | 15 1/8  | 15 7/8  | 11 1/2          | 12 7/8         | 17 1/8          | 11 5/8         | 13 1/4 | 19 1/4 |
| 12                | 12 1/16    | 12 7/8          | 13 3/4  | 15 1/4         | 15 1/8  | 13              | 14 1/8  | 16 3/8           | 16 3/8  | 16 1/4  | 15 7/8  | 16 7/8  | 12 5/8          | 14             | 18 1/2          | 12 3/4         | 14 1/2 | 20 3/4 |
| 13                | 13 1/16    | 14 1/2          | 15 5/8  | 16 1/2         | 16 3/8  | 14 1/4          | 15 5/8  | 17 1/2           | 17 1/2  | 17 3/8  | 17 3/4  | 18 1/4  | 13 5/8          | 15 5/8         | 19 3/4          | 13 3/4         | 15 1/2 | 22     |
| 14                | 14 1/16    | 15 1/2          | 16 3/8  | 17 5/8         | 17 5/8  | 15 1/4          | 16 3/8  | 18 1/2           | 18 1/2  | 18 3/8  | 18 3/4  | 19 1/2  | 14 5/8          | 16 1/8         | 21 1/4          | -              | -      | -      |
| 15                | 15 1/16    | 16 1/2          | 17 3/8  | 18 5/8         | 18 5/8  | 16 1/4          | 17 3/8  | 19 1/2           | 19 1/2  | 19 3/8  | 20      | 20 1/2  | 15 3/4          | 17 1/4         | 22 7/8          | -              | -      | -      |
| 16                | 16 1/16    | 17 1/2          | 18 3/8  | 19 5/8         | 19 5/8  | 17 1/2          | 18 3/4  | 20 3/4           | 20 3/4  | 20 5/8  | 21      | 21 3/4  | 16 3/4          | 18 3/8         | 24 1/4          | -              | -      | -      |
| 17                | 17 1/16    | 18 5/8          | 19 5/8  | 20 7/8         | 20 3/4  | 18 1/2          | 19 7/8  | 22               | 22      | 21 7/8  | 22 1/4  | 22 3/4  | -               | -              | -               | -              | -      | -      |
| 18                | 18 1/16    | 19 5/8          | 20 5/8  | 22 1/8         | 22 1/8  | 19 1/2          | 20 7/8  | 22 7/8           | 22 7/8  | 22 3/4  | 24 3/8  | 25 1/8  | -               | -              | -               | -              | -      | -      |
| 19                | 19 1/16    | 20 5/8          | 21 5/8  | 23 3/8         | 23 3/8  | 20 5/8          | 22 1/8  | 24 1/8           | 24 1/8  | 24      | -       | -       | -               | -              | -               | -              | -      | -      |
| 20                | 20 1/16    | 21 5/8          | 22 5/8  | 24 3/8         | 24 3/8  | 21 5/8          | 23 3/8  | 25 3/8           | 25 3/8  | 25 1/4  | 26 1/2  | 27 1/4  | -               | -              | -               | -              | -      | -      |
| 21                | 21 1/16    | 22 5/8          | 23 3/4  | 25 5/8         | 25 1/2  | 22 5/8          | 24 3/8  | 26 3/8           | 26 3/8  | 26 1/4  | -       | -       | -               | -              | -               | -              | -      | -      |
| 22                | 22 1/16    | 23 5/8          | 24 3/4  | 26 1/2         | 26 1/2  | 23 5/8          | 25 3/8  | 27 3/8           | 27 3/8  | 27 1/4  | 28 3/4  | 29 3/4  | -               | -              | -               | -              | -      | -      |
| 23                | 23 1/16    | 24 5/8          | 25 3/4  | 27 1/2         | 27 1/2  | 24 5/8          | 26 3/8  | 28 1/2           | 28 1/2  | 28 3/8  | -       | -       | -               | -              | -               | -              | -      | -      |
| 24                | 24 1/16    | 25 5/8          | 26 3/4  | 28 3/4         | 28 5/8  | 25 5/8          | 27 3/8  | 29 1/2           | 29 1/2  | 29 3/8  | -       | -       | -               | -              | -               | -              | -      | -      |

DIMENSIONS IN INCHES.

NOTE: Special gasket dimensions are required when an inner ring is fitted to gaskets for Tables S and T. Please request details.

## STYLE CG & CGI TO BS 4865 PART 2 TO SUIT BS 4504 FLANGES

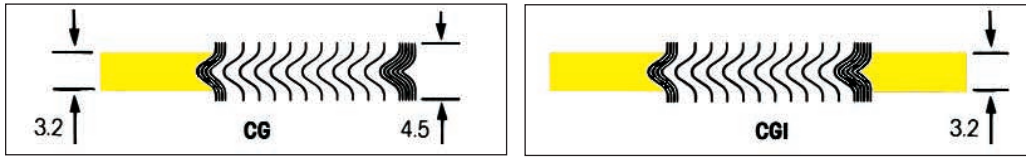

TABLE  
12

| Nominal Pipe Size | Inner Ring Inside Diameter | Sealing Element PN10-PN40 |              | Centering Ring Outside Diameter |      |      |      |
|-------------------|----------------------------|---------------------------|--------------|---------------------------------|------|------|------|
|                   |                            | Inside Dia.               | Outside Dia. | PN10                            | PN16 | PN25 | PN40 |
| 10                | 15                         | 23.6                      | 36.4         | 48                              | 48   | 48   | 48   |
| 15                | 19                         | 27.6                      | 40.4         | 53                              | 53   | 53   | 53   |
| 20                | 24                         | 33.6                      | 47.4         | 63                              | 63   | 63   | 63   |
| 25                | 30                         | 40.6                      | 55.4         | 73                              | 73   | 73   | 73   |
| 32                | 39                         | 49.6                      | 66.4         | 84                              | 84   | 84   | 84   |
| 40                | 45                         | 55.6                      | 72.4         | 94                              | 94   | 94   | 94   |
| 50                | 56                         | 67.6                      | 86.4         | 109                             | 109  | 109  | 109  |
| 65                | 72                         | 83.6                      | 103.4        | 129                             | 129  | 129  | 129  |
| 80                | 84                         | 96.6                      | 117.4        | 144                             | 144  | 144  | 144  |
| 100               | 108                        | 122.6                     | 144.4        | 164                             | 164  | 170  | 170  |
| 125               | 133                        | 147.6                     | 170.4        | 194                             | 194  | 196  | 196  |
| 150               | 160                        | 176.6                     | 200.4        | 220                             | 220  | 226  | 226  |
| 200               | 209                        | 228.6                     | 255.4        | 275                             | 275  | 286  | 293  |
| 250               | 262                        | 282.4                     | 310.4        | 330                             | 331  | 343  | 355  |
| 300               | 311                        | 331.6                     | 360.4        | 380                             | 386  | 403  | 420  |
| 350               | 355                        | 374.6                     | 405.4        | 440                             | 446  | 460  | 477  |
| 400               | 406                        | 425.6                     | 458.4        | 491                             | 498  | 517  | 549  |
| 450               | 452                        | 476.6                     | 512.4        | 541                             | 558  | 567  | 574  |
| 500               | 508                        | 527.6                     | 566.4        | 596                             | 620  | 627  | 631  |
| 600               | 610                        | 634.6                     | 675.4        | 698                             | 737  | 734  | 750  |
| 700               | 710                        | 734.0                     | 778.5        | 813                             | 807  | 836  | -    |
| 800               | 811                        | 835.0                     | 879.5        | 920                             | 914  | 945  | -    |
| 900               | 909                        | 933.0                     | 980.5        | 1020                            | 1014 | 1045 | -    |

DIMENSIONS IN mm.

The use of an inner ring is recommended for gaskets for use with PN25 and PN40 flanges.  
Inner rings may be fitted also to gaskets for use with PN10 and PN16 flanges.

# STYLE CG & CGI TO SUIT DIN FLANGES PN 10-PN 250

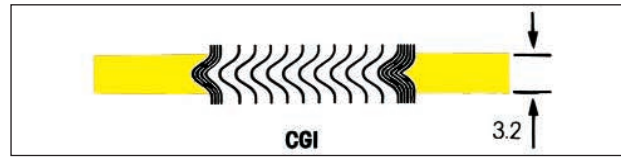
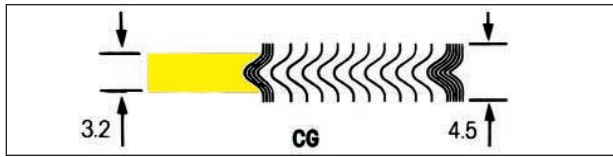

TABLE  
13

| NOMINAL PIPE SIZE (DN) | INNER RING INSIDE DIAMETER | SEALING ELEMENT INSIDE DIAMETER | SEALING ELEMENT OUTSIDE DIAMETER |            | (DN) |      |      |      |      |       |       |       |
|------------------------|----------------------------|---------------------------------|----------------------------------|------------|------|------|------|------|------|-------|-------|-------|
|                        |                            |                                 | PN10-PN40                        | PN64-PN250 | PN10 | PN16 | PN25 | PN40 | PN64 | PN100 | PN160 | PN250 |
| 10                     | 18                         | 24                              | 36                               | 36         | 46   | 46   | 46   | 46   | 56   | 56    | 56    | 67    |
| 15                     | 24                         | 30                              | 42                               | 42         | 51   | 51   | 51   | 51   | 61   | 61    | 61    | 72    |
| 20                     | 27                         | 33                              | 47                               | 47         | 61   | 61   | 61   | 61   | 72   | 72    | -     | -     |
| 25                     | 34                         | 40                              | 54                               | 54         | 71   | 71   | 71   | 71   | 82   | 82    | 82    | 83    |
| 32                     | 44                         | 50                              | 66                               | 66         | 82   | 82   | 82   | 82   | 87   | 87    | -     | -     |
| 40                     | 51                         | 57                              | 73                               | 73         | 92   | 92   | 92   | 92   | 103  | 103   | 103   | 109   |
| 50                     | 59                         | 69                              | 87                               | 87         | 107  | 107  | 107  | 107  | 113  | 119   | 119   | 124   |
| 65                     | 73                         | 83                              | 103                              | 105        | 127  | 127  | 127  | 127  | 138  | 144   | 144   | 154   |
| 80                     | 87                         | 97                              | 117                              | 121        | 142  | 142  | 142  | 142  | 148  | 154   | 154   | 170   |
| 100                    | 114                        | 124                             | 144                              | 148        | 162  | 162  | 168  | 168  | 174  | 180   | 180   | 202   |
| 125                    | 140                        | 150                             | 172                              | 176        | 192  | 192  | 194  | 194  | 210  | 217   | 217   | 242   |
| 150                    | 168                        | 178                             | 200                              | 204        | 217  | 217  | 224  | 224  | 247  | 257   | 257   | 284   |
| 175                    | 189                        | 199                             | 225                              | 231        | 247  | 247  | 254  | 265  | 277  | 287   | 284   | 316   |
| 200                    | 220                        | 230                             | 256                              | 262        | 272  | 272  | 284  | 290  | 309  | 324   | 324   | 358   |
| 250                    | 269                        | 279                             | 307                              | 315        | 327  | 328  | 340  | 352  | 364  | 391   | 388   | 442   |
| 300                    | 319                        | 329                             | 357                              | 365        | 377  | 383  | 400  | 417  | 424  | 458   | 458   | 538   |
| 350                    | 365                        | 375                             | 405                              | 413        | 437  | 443  | 457  | 474  | 486  | 512   | -     | -     |
| 400                    | 416                        | 426                             | 458                              | 466        | 488  | 495  | 514  | 546  | 543  | 572   | -     | -     |
| 500                    | 520                        | 530                             | 566                              | 574        | 593  | 617  | 624  | 628  | 657  | 704   | -     | -     |
| 600                    | 615                        | 630                             | 666                              | 674        | 695  | 734  | 731  | 747  | 764  | 813   | -     | -     |
| 700                    | 715                        | 730                             | 770                              | 778        | 810  | 804  | 833  | 852  | 879  | -     | -     | -     |
| 800                    | 815                        | 830                             | 874                              | 882        | 917  | 911  | 942  | 974  | 988  | -     | -     | -     |
| 900                    | 915                        | 930                             | 974                              | 982        | 1017 | 1011 | 1042 | 1084 | 1108 | -     | -     | -     |
| 1000                   | 1015                       | 1030                            | 1078                             | 1086       | 1124 | 1128 | 1154 | 1194 | 1220 | -     | -     | -     |

DIMENSIONS IN mm.

The use of an inner ring is recommended for gaskets for use with PN100 Flanges and above.  
Gasket dimensions are available to suit PN320 Flanges, consult the technical department.

# STYLE R

## FOR USE WITH MALE & FEMALE AND TONGUE & GROOVE ASME B16.5 & BS 1560 FLANGES

Standard Style R gaskets embody all the exclusive features of Flexitallc design for keeping compression values in balance with bolting and providing adequate resilience to compensate for variable stresses encountered in service. Standard Style R gaskets are manufactured to a nominal thickness of .125" (3.2mm). Optimum compression is in the range of .090" to .100" (2.3mm to 2.5mm) thick.

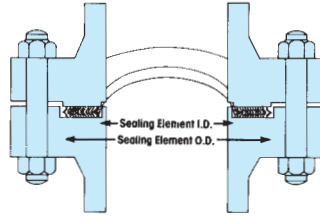

There are three types of Style R gaskets:

- (a) Style R-1 indicates gaskets for use with large male and female flanges.\*
- (b) Style R-3 indicates gaskets for use with large tongue and groove flanges.
- (c) Style R-4 indicates gaskets for use with small tongue and groove flanges.

\*As a general rule, the use of Flexitallc Spiral-Wound Gaskets with small male and female flange facings is not recommended.

Dimensional limitations established by the proportions of the small tongue and groove facings limit the possibility of increasing gasket dimensions to improve the load carrying capacity in the higher pressure series. For this reason, it is suggested that large tongue and groove facings be selected for new construction when class 900, 1500 and 2500 flanges are to be used. Style R-4 gaskets maybe compressed an additional amount when exposed to the higher bolt loads, but not to the degree that the gasket will be crushed due to the radial support provided by the confining groove.

Special Style R gaskets are adaptable to non-standard flanges and can be designed and manufactured according to specifications for high and low pressure applications and for severe corrosive conditions.

When ordering special Style R gaskets for non-standard flanges and for special applications, furnish complete data on Flexitallc Gasket Engineering Data Form.

NOTE - The following Style R gaskets are interchangeable:

Style R-1 and R-3 gaskets

- 1/4" sizes - Classes 150, 300, 400 and 600 are interchangeable.
- 1/2" sizes - Classes 150, 300, 400, 600, 900, 1500 and 2500 (R-3 only) are interchangeable.
- All R-1 and R-3 gaskets in Classes 300, 400 and 600 are interchangeable within their size category.
- All R-1 and R-3 gaskets in Classes 900 and 1500 are interchangeable within their size category.

Style R-4 gaskets

- 1/2" sizes - interchangeable with all NPS 1/2" R-1 and R-3 gaskets within the same pressure rating.
- 3/4" interchangeable with all 3/4" R-1 and R-3 gaskets within the same pressure rating.
- All R-4 gaskets in Classes 300 through 2500 are interchangeable within their size category.

TABLE 14

| Nominal Pipe Size | Style R1 for Large Male and Female |       |        |       |                            |       |        |       | Style R3 for Large Tongue and Groove |       |        |       | Style R4 for Small Tongue and Groove |       |         |       |
|-------------------|------------------------------------|-------|--------|-------|----------------------------|-------|--------|-------|--------------------------------------|-------|--------|-------|--------------------------------------|-------|---------|-------|
|                   | Sealing Element Class 150-1500     |       |        |       | Sealing Element Class 2500 |       |        |       | Sealing Element Class 150-2500       |       |        |       | Sealing Element Class 150-2500       |       |         |       |
|                   | ID                                 | OD    | ID     | OD    | ID                         | OD    | ID     | OD    | ID                                   | OD    | ID     | OD    | ID                                   | OD    |         |       |
| 1/4               | 1/2                                | 12.7  | 1      | 25.4  | -                          | -     | -      | -     | 1/2                                  | 12.7  | 1      | 25.4  | -                                    | -     | -       | -     |
| 1/2               | 1                                  | 25.4  | 1 3/8  | 34.9  | 1 3/16                     | 20.6  | 1 3/8  | 34.9  | 1                                    | 25.4  | 1 3/8  | 34.9  | 1                                    | 25.4  | 1 3/8   | 34.9  |
| 3/4               | 1 1/16                             | 33.3  | 1 1/16 | 42.9  | 1 1/16                     | 27.0  | 1 1/16 | 42.9  | 1 1/16                               | 33.3  | 1 1/16 | 42.9  | 1 1/16                               | 33.3  | 1 1/16  | 42.9  |
| 1                 | 1 1/2                              | 38.1  | 2      | 50.8  | 1 1/4                      | 31.8  | 2      | 50.8  | 1 1/2                                | 38.1  | 2      | 50.8  | 1 1/2                                | 38.1  | 1 3/8   | 47.6  |
| 1 1/4             | 1 7/8                              | 47.6  | 2 1/2  | 63.5  | 1 5/8                      | 41.3  | 2 1/2  | 63.5  | 1 7/8                                | 47.6  | 2 1/2  | 63.5  | 1 7/8                                | 47.6  | 2 1/4   | 57.2  |
| 1 1/2             | 2 1/8                              | 54.0  | 2 7/8  | 73.0  | 1 7/8                      | 47.6  | 2 7/8  | 73.0  | 2 1/8                                | 54.0  | 2 7/8  | 73.0  | 2 1/8                                | 54.0  | 2 1/2   | 63.5  |
| 2                 | 2 3/8                              | 73.0  | 3 5/8  | 91.1  | 2 3/8                      | 60.3  | 3 5/8  | 92.1  | 2 3/8                                | 73.0  | 3 5/8  | 92.1  | 2 3/8                                | 73.0  | 3 1/4   | 82.6  |
| 2 1/2             | 3 3/8                              | 85.7  | 4 1/8  | 104.8 | 3                          | 76.2  | 4 1/8  | 104.8 | 3 3/8                                | 85.7  | 4 1/8  | 104.8 | 3 3/8                                | 85.7  | 3 3/4   | 95.3  |
| 3                 | 4 1/4                              | 108.0 | 5      | 127.0 | 3 3/4                      | 95.3  | 5      | 127.0 | 4 1/4                                | 108.0 | 5      | 127.0 | 4 1/4                                | 108.0 | 4 5/8   | 117.5 |
| 3 1/2             | 4 3/4                              | 120.7 | 5 1/2  | 139.7 | -                          | -     | -      | -     | 4 3/4                                | 120.7 | 5 1/2  | 139.7 | 4 3/4                                | 120.7 | 5 1/8   | 130.2 |
| 4                 | 5 1/16                             | 131.8 | 6 3/16 | 157.2 | 4 3/4                      | 120.7 | 6 3/16 | 157.2 | 5 1/16                               | 131.8 | 6 3/16 | 157.2 | 5 1/16                               | 131.8 | 5 1/16  | 144.5 |
| 4 1/2             | 5 11/16                            | 144.5 | 6 3/4  | 171.5 | -                          | -     | -      | -     | 5 11/16                              | 144.5 | 6 3/4  | 171.5 | -                                    | -     | -       | -     |
| 5                 | 6 5/16                             | 160.3 | 7 5/16 | 185.7 | 5 3/4                      | 146.1 | 7 5/16 | 185.7 | 6 5/16                               | 160.3 | 7 5/16 | 185.7 | 6 5/16                               | 160.3 | 6 13/16 | 173.0 |
| 6                 | 7 1/2                              | 190.5 | 8 1/2  | 215.9 | 6 3/4                      | 171.5 | 8 1/2  | 215.9 | 7 1/2                                | 190.5 | 8 1/2  | 215.9 | 7 1/2                                | 190.5 | 8       | 203.2 |
| 8                 | 9 3/8                              | 238.1 | 10 5/8 | 269.9 | 8 3/4                      | 222.3 | 10 5/8 | 269.9 | 9 3/8                                | 238.1 | 10 5/8 | 269.9 | 9 3/8                                | 238.1 | 10      | 254.0 |
| 10                | 11 1/4                             | 285.8 | 12 3/4 | 323.9 | 10 3/4                     | 273.1 | 12 3/4 | 323.9 | 11 1/4                               | 285.8 | 12 3/4 | 323.9 | 11 1/4                               | 285.8 | 12      | 304.8 |
| 12                | 13 1/2                             | 342.9 | 15     | 381.0 | 13                         | 330.2 | 15     | 381.0 | 13 1/2                               | 342.9 | 15     | 381.0 | 13 1/2                               | 342.9 | 14 1/4  | 362.0 |
| 14                | 14 3/4                             | 374.7 | 16 1/4 | 412.8 | -                          | -     | -      | -     | 14 3/4                               | 374.7 | 16 1/4 | 412.8 | 14 3/4                               | 374.7 | 15 1/2  | 393.7 |
| 16                | 17                                 | 425.5 | 18 1/2 | 469.9 | -                          | -     | -      | -     | 17                                   | 425.5 | 18 1/2 | 469.9 | 16 3/4                               | 425.5 | 17 5/8  | 447.7 |
| 18                | 19 3/4                             | 489.0 | 21     | 533.4 | -                          | -     | -      | -     | 19 3/4                               | 489.0 | 21     | 533.4 | 19 3/4                               | 489.0 | 20 1/8  | 511.2 |
| 20                | 21                                 | 533.4 | 23     | 584.2 | -                          | -     | -      | -     | 21                                   | 533.4 | 23     | 584.2 | 21                                   | 533.4 | 22      | 558.2 |
| 24                | 25 1/4                             | 641.4 | 27 1/4 | 692.2 | -                          | -     | -      | -     | 25 1/4                               | 641.4 | 27 1/4 | 692.2 | 25 1/4                               | 641.4 | 26 1/4  | 666.8 |

DIMENSIONS IN INCHES & mm.

NOTE: Style R3 for NPS 1/4 are for class 150 to 600 only. Style R3 for NPS 4 1/2 are for class 150 to 1500 only.

# STYLE RIR

FOR USE WITH LARGE MALE & FEMALE ASME B16.5 and BS1560 FLANGES

TABLE 15

| Nominal Pipe Size | Style R1 for Large Male and Female |       |                            |       |         |       |                                |       |         |       |
|-------------------|------------------------------------|-------|----------------------------|-------|---------|-------|--------------------------------|-------|---------|-------|
|                   | Inner Ring                         |       | Sealing Element Class 2500 |       |         |       | Sealing Element Class 150-2500 |       |         |       |
|                   | ID                                 |       | ID                         | OD    |         | ID    | OD                             |       | ID      | OD    |
| 1/4               | -                                  | -     | 1/2                        | 12.7  | 1       | 25.4  | -                              | -     | -       | -     |
| 1/2               | 9/16                               | 14.3  | 1                          | 25.4  | 1 3/8   | 34.9  | 1 3/16                         | 20.6  | 1 3/8   | 34.9  |
| 3/4               | 1 3/16                             | 20.6  | 1 5/16                     | 33.3  | 1 11/16 | 42.9  | 1 1/16                         | 27.0  | 1 11/16 | 42.9  |
| 1                 | 1 1/16                             | 27.0  | 1 1/2                      | 38.1  | 2       | 50.8  | 1 1/4                          | 31.8  | 2       | 50.8  |
| 1 1/4             | 1 3/8                              | 34.9  | 1 7/8                      | 47.6  | 2 1/2   | 63.5  | 1 5/8                          | 41.3  | 2 1/2   | 63.5  |
| 1 1/2             | 1 5/8                              | 41.3  | 2 1/8                      | 54.0  | 2 7/8   | 73.0  | 1 7/8                          | 47.6  | 2 7/8   | 73.0  |
| 2                 | 2 1/16                             | 52.4  | 2 3/8                      | 73.0  | 3 5/8   | 92.1  | 2 3/8                          | 60.3  | 3 5/8   | 92.1  |
| 2 1/2             | 2 1/2                              | 63.5  | 3 3/8                      | 85.7  | 4 1/8   | 104.8 | 3                              | 76.2  | 4 1/8   | 104.8 |
| 3                 | 3 1/16                             | 77.8  | 4 1/4                      | 108.0 | 5       | 127.0 | 3 3/4                          | 95.3  | 5       | 127.0 |
| 3 1/2             | 3 1/16                             | 90.5  | 4 3/4                      | 120.7 | 5 1/2   | 139.7 | -                              | -     | -       | -     |
| 4                 | 4 1/16                             | 103.2 | 5 3/16                     | 131.8 | 6 3/16  | 157.2 | 4 3/4                          | 120.7 | 6 3/16  | 157.2 |
| 4 1/2             | 4 9/16                             | 115.9 | 5 11/16                    | 144.5 | 6 3/4   | 171.5 | -                              | -     | -       | -     |
| 5                 | 5 1/16                             | 128.6 | 6 5/16                     | 160.3 | 7 5/16  | 185.7 | 5 3/4                          | 146.1 | 7 5/16  | 185.7 |
| 6                 | 6 1/16                             | 154.0 | 7 1/2                      | 190.5 | 8 1/2   | 215.9 | 6 3/4                          | 171.5 | 8 1/2   | 215.9 |
| 8                 | 8                                  | 203.2 | 9 3/8                      | 238.1 | 10 5/8  | 269.9 | 8 3/4                          | 222.3 | 10 5/8  | 269.9 |
| 10                | 10                                 | 254.0 | 11 1/4                     | 285.8 | 12 3/4  | 323.9 | 10 3/4                         | 273.1 | 12 3/4  | 323.9 |
| 12                | 11 15/16                           | 303.2 | 13 1/2                     | 342.9 | 15      | 381.0 | 13                             | 330.2 | 15      | 381.0 |
| 14                | 13 1/2                             | 342.9 | 14 3/4                     | 374.7 | 16 1/4  | 412.8 | -                              | -     | -       | -     |
| 16                | 15 1/2                             | 393.7 | 16 3/4                     | 425.5 | 18 1/2  | 469.9 | -                              | -     | -       | -     |
| 18                | 17 1/2                             | 444.5 | 19 1/4                     | 489.0 | 21      | 533.4 | -                              | -     | -       | -     |
| 20                | 19 1/2                             | 495.3 | 21                         | 533.4 | 23      | 584.2 | -                              | -     | -       | -     |
| 24                | 23 1/2                             | 596.9 | 25 1/4                     | 641.4 | 27 1/4  | 692.2 | -                              | -     | -       | -     |

DIMENSIONS IN INCHES & mm.

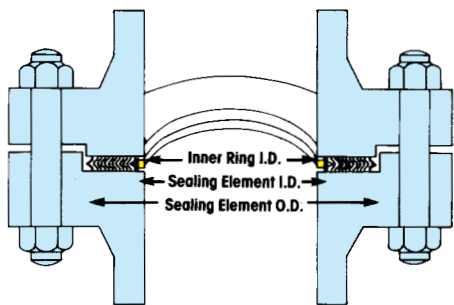

Standard 'RIR' gaskets are manufactured to 0.125" (3.2mm) thickness. The gasket features a solid metal inner ring nominally 0.090" (2.3mm) thick, as an integrated part of its design. The inner ring provides a positive stop preventing the gasket from over compression and possible damage. Special styles are available in other thickness.

## STYLE CG & CGI TO SUIT JIS FLANGES PRESSURE RATING 10Kgf/cm<sup>2</sup> – 16-20Kgf/cm<sup>2</sup>

TABLE 16

| Nom. Pipe Size | Inner Ring Inside Dia. | Sealing Element |              | Centering Ring Outside Dia. |
|----------------|------------------------|-----------------|--------------|-----------------------------|
|                |                        | Inside Dia.     | Outside Dia. |                             |
|                |                        | 10              | -            |                             |
| 15             | -                      | 28              | 41           | 57                          |
| 20             | -                      | 34              | 47           | 62                          |
| 25             | -                      | 40              | 53           | 74                          |
| 32             | -                      | 51              | 67           | 84                          |
| 40             | -                      | 57              | 73           | 89                          |
| 50             | -                      | 69              | 89           | 104                         |
| 65             | -                      | 87              | 107          | 124                         |
| 80             | -                      | 98              | 118          | 134                         |
| 90             | -                      | 110             | 130          | 144                         |
| 100            | -                      | 123             | 143          | 159                         |
| 125            | -                      | 148             | 173          | 190                         |
| 150            | -                      | 174             | 199          | 220                         |
| 175            | -                      | 201             | 226          | 245                         |
| 200            | -                      | 227             | 252          | 270                         |
| 225            | -                      | 252             | 277          | 290                         |
| 250            | -                      | 278             | 310          | 332                         |
| 300            | -                      | 329             | 361          | 377                         |
| 350            | -                      | 366             | 406          | 422                         |
| 400            | -                      | 417             | 457          | 484                         |
| 450            | -                      | 468             | 518          | 539                         |
| 500            | -                      | 518             | 568          | 594                         |
| 550            | -                      | 569             | 619          | 650                         |
| 600            | -                      | 620             | 670          | 700                         |

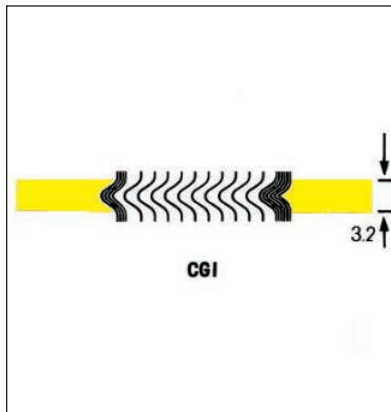
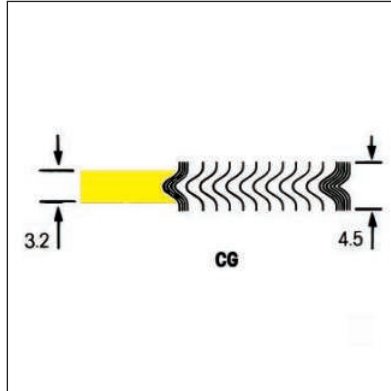

| Nom. Pipe Size | Inner Ring Inside Dia. | Sealing Element |              | Centering Ring Outside Dia. |
|----------------|------------------------|-----------------|--------------|-----------------------------|
|                |                        | Inside Dia.     | Outside Dia. |                             |
|                |                        | 10              | 18           |                             |
| 15             | 22                     | 28              | 41           | 57                          |
| 20             | 28                     | 34              | 47           | 62                          |
| 25             | 34                     | 40              | 53           | 74                          |
| 32             | 43                     | 51              | 67           | 84                          |
| 40             | 49                     | 57              | 73           | 89                          |
| 50             | 61                     | 69              | 89           | 104                         |
| 65             | 77                     | 87              | 107          | 124                         |
| 80             | 89                     | 99              | 119          | 140                         |
| 90             | 102                    | 114             | 139          | 150                         |
| 100            | 115                    | 127             | 152          | 165                         |
| 125            | 140                    | 152             | 177          | 202                         |
| 150            | 166                    | 182             | 214          | 237                         |
| 175            | -                      | -               | -            | -                           |
| 200            | 217                    | 233             | 265          | 282                         |
| 225            | -                      | -               | -            | -                           |
| 250            | 268                    | 288             | 328          | 354                         |
| 300            | 319                    | 339             | 379          | 404                         |
| 350            | 356                    | 376             | 416          | 450                         |
| 400            | 407                    | 432             | 482          | 508                         |
| 450            | 458                    | 483             | 533          | 573                         |
| 500            | 508                    | 533             | 583          | 628                         |
| 550            | 559                    | 584             | 634          | 684                         |
| 600            | 610                    | 635             | 685          | 734                         |

DIMENSIONS IN mm.

## STYLE CG & CGI TO SUIT JIS FLANGES PRESSURE RATING 30Kgf/cm<sup>2</sup> - 63Kgf/cm<sup>2</sup>

TABLE 17

| Nom. Pipe Size | Inner Ring Inside Dia. | Sealing Element |              | Centering Ring Outside Dia. |
|----------------|------------------------|-----------------|--------------|-----------------------------|
|                |                        | Inside Dia.     | Outside Dia. |                             |
|                |                        | 10              | 18           |                             |
| 15             | 22                     | 28              | 41           | 64                          |
| 20             | 28                     | 34              | 47           | 69                          |
| 25             | 34                     | 40              | 53           | 79                          |
| 32             | 43                     | 51              | 67           | 89                          |
| 40             | 49                     | 57              | 73           | 100                         |
| 50             | 61                     | 69              | 89           | 114                         |
| 65             | 68                     | 78              | 98           | 140                         |
| 80             | 80                     | 90              | 110          | 150                         |
| 90             | 92                     | 102             | 127          | 162                         |
| 100            | 104                    | 116             | 141          | 172                         |
| 125            | 128                    | 140             | 165          | 207                         |
| 150            | 153                    | 165             | 197          | 249                         |
| 200            | 202                    | 218             | 250          | 294                         |
| 250            | 251                    | 271             | 311          | 360                         |
| 300            | 300                    | 320             | 360          | 418                         |
| 350            | 336                    | 356             | 396          | 463                         |
| 400            | 383                    | 403             | 453          | 524                         |

| Nom. Pipe Size | Inner Ring Inside Dia. | Sealing Element |              | Centering Ring Outside Dia. |
|----------------|------------------------|-----------------|--------------|-----------------------------|
|                |                        | Inside Dia.     | Outside Dia. |                             |
|                |                        | 10              | 15           |                             |
| 15             | 18                     | 24              | 37           | 64                          |
| 20             | 23                     | 29              | 42           | 69                          |
| 25             | 29                     | 35              | 48           | 79                          |
| 32             | 38                     | 44              | 60           | 89                          |
| 40             | 43                     | 51              | 67           | 100                         |
| 50             | 55                     | 63              | 79           | 114                         |
| 65             | 68                     | 78              | 98           | 140                         |
| 80             | 80                     | 90              | 110          | 150                         |
| 90             | 92                     | 102             | 127          | 162                         |
| 100            | 104                    | 116             | 141          | 182                         |
| 125            | 128                    | 140             | 165          | 224                         |
| 150            | 153                    | 165             | 197          | 265                         |
| 200            | 202                    | 218             | 250          | 315                         |
| 250            | 251                    | 271             | 311          | 378                         |
| 300            | 300                    | 320             | 360          | 434                         |
| 350            | 336                    | 356             | 396          | 479                         |
| 400            | 383                    | 403             | 453          | 531                         |

| Nom. Pipe Size | Inner Ring Inside Dia. | Sealing Element |              | Centering Ring Outside Dia. |
|----------------|------------------------|-----------------|--------------|-----------------------------|
|                |                        | Inside Dia.     | Outside Dia. |                             |
|                |                        | 10              | 15           |                             |
| 15             | 18                     | 24              | 37           | 69                          |
| 20             | 23                     | 29              | 42           | 75                          |
| 25             | 29                     | 35              | 48           | 80                          |
| 32             | 38                     | 44              | 60           | 90                          |
| 40             | 43                     | 51              | 67           | 107                         |
| 50             | 55                     | 63              | 79           | 125                         |
| 65             | 68                     | 78              | 98           | 152                         |
| 80             | 80                     | 90              | 110          | 162                         |
| 90             | 92                     | 102             | 127          | 179                         |
| 100            | 104                    | 116             | 141          | 194                         |
| 125            | 128                    | 140             | 165          | 235                         |
| 150            | 153                    | 165             | 197          | 275                         |
| 200            | 202                    | 218             | 250          | 328                         |
| 250            | 251                    | 271             | 311          | 394                         |
| 300            | 300                    | 320             | 360          | 446                         |
| 350            | 336                    | 356             | 396          | 488                         |
| 400            | 383                    | 403             | 453          | 545                         |

DIMENSIONS IN mm.

# STYLE CG-RJ & CGI-RJ SPIRAL-WOUND GASKETS FOR USE IN ASME B16.5 AND API 6A RING-JOINT FLANGES

CG-RJ and CGI-RJ spiral wound gaskets are designed for use, as a replacement maintenance item, of standard oval and octagonal ring joint gaskets.

These gaskets are available for NPS 1/2 to 24 and pressure classes 150 to 1500.

Gasket thickness is 0.175" ( 4.5mm) and the outer ring thickness is 0.125" (3.2mm).

Style CGI-RJ gaskets are fitted with an inner ring 0.125 (3.2mm) thick.

Flexitallic recommends CGI-RJ gaskets for pressure classes 900 and above, and where operating temperatures are above 572 F (300 C).

Consult our technical department for CGI-RJ gasket dimensions.

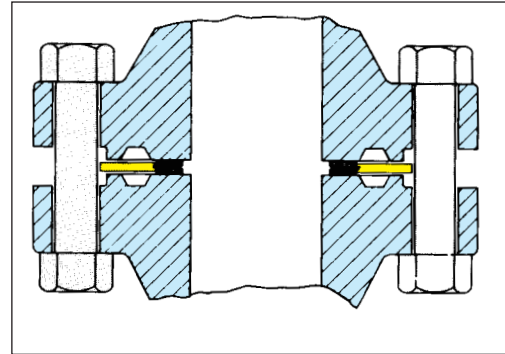

Note: Clearance dimensions between flange faces should be checked on close coupling pipework prior to installation of CG-RJ and CGI-RJ gaskets to ensure that optimum compression can be achieved without over stressing bolts and or flanges.

It is the user's responsibility to ensure that there is sufficient clearance between the flange bore and ring groove for proper seating of the gasket.

Dimensions are listed below for CG-RJ spiral wound gaskets. Flexitallic's technical department should be consulted for CGI-RJ and API gasket sizes.

TABLE  
18

| Nom. Pipe Size | PRESSURE CLASS |           |         |           |           |         |           |           |         |           |           |         |           |           |         |           |           |         |
|----------------|----------------|-----------|---------|-----------|-----------|---------|-----------|-----------|---------|-----------|-----------|---------|-----------|-----------|---------|-----------|-----------|---------|
|                | 150            |           |         | 300       |           |         | 400       |           |         | 600       |           |         | 900       |           |         | 1500      |           |         |
|                | Gasket ID      | Gasket OD | Ring OD | Gasket ID | Gasket OD | Ring OD | Gasket ID | Gasket OD | Ring OD | Gasket ID | Gasket OD | Ring OD | Gasket ID | Gasket OD | Ring OD | Gasket ID | Gasket OD | Ring OD |
| 1/2            | -              | -         | -       | 1 1/16    | 1 1/16    | 2 1/8   | 1 1/16    | 1 1/16    | 2 1/8   | 1 1/16    | 1 1/16    | 2 1/8   | 1 1/16    | 1 1/16    | 2 1/2   | 1 1/16    | 1 1/16    | 2 1/2   |
| 3/4            | -              | -         | -       | 7/8       | 1 5/16    | 2 5/8   | 7/8       | 1 5/16    | 2 5/8   | 7/8       | 1 5/16    | 2 5/8   | 7/8       | 1 3/8     | 2 3/4   | 7/8       | 1 3/8     | 2 3/4   |
| 1              | 1 1/8          | 1 5/8     | 2 5/8   | 1 1/8     | 1 5/8     | 2 7/8   | 1 1/8     | 1 5/8     | 2 7/8   | 1 1/8     | 1 5/8     | 2 7/8   | 1 1/8     | 1 5/8     | 3 1/8   | 1 1/8     | 1 5/8     | 3 1/8   |
| 1 1/4          | 1 7/16         | 1 7/8     | 3       | 1 7/16    | 2         | 3 1/4   | 1 7/16    | 2         | 3 1/4   | 1 7/16    | 2         | 3 1/4   | 1 7/16    | 2         | 3 1/2   | 1 7/16    | 2         | 3 1/2   |
| 1 1/2          | 1 11/16        | 2 3/16    | 3 3/8   | 1 11/16   | 2 3/8     | 3 3/4   | 1 11/16   | 2 3/8     | 3 3/4   | 1 11/16   | 2 3/8     | 3 3/4   | 1 11/16   | 2 3/8     | 3 3/8   | 1 11/16   | 2 3/8     | 3 3/8   |
| 2              | 2 1/8          | 2 7/8     | 4 1/8   | 2 1/8     | 2 3/4     | 4 3/8   | 2 1/8     | 2 3/4     | 4 3/8   | 2 1/8     | 2 3/4     | 4 3/8   | 2 1/8     | 3 1/4     | 5 5/8   | 2 1/8     | 3 1/4     | 5 5/8   |
| 2 1/2          | 2 3/4          | 3 5/16    | 4 7/8   | 2 3/4     | 3 5/16    | 5 1/8   | 2 3/4     | 3 5/16    | 5 1/8   | 2 3/4     | 3 5/16    | 5 1/8   | 2 3/4     | 3 3/8     | 6 1/2   | 2 3/4     | 3 3/8     | 6 1/2   |
| 3              | 3 5/16         | 3 15/16   | 5 3/8   | 3 5/16    | 3 15/16   | 5 7/8   | 3 5/16    | 3 15/16   | 5 7/8   | 3 5/16    | 3 15/16   | 5 7/8   | 3 5/16    | 4 3/16    | 6 5/8   | 3 5/16    | 4 11/16   | 6 7/8   |
| 4              | 4 5/16         | 5 3/16    | 6 7/8   | 4 5/16    | 5 3/16    | 7 1/8   | 4 5/16    | 5 3/16    | 7 1/8   | 4 5/16    | 5 3/16    | 7 1/8   | 4 5/16    | 5 3/16    | 8 1/8   | 4 5/16    | 5 11/16   | 8 1/4   |
| 5              | 5 5/16         | 6 3/16    | 7 3/4   | 5 5/16    | 6 7/16    | 8 1/2   | 5 5/16    | 6 7/16    | 8 3/8   | 5 5/16    | 6 7/16    | 9 1/2   | 5 5/16    | 6 7/16    | 9 3/4   | 5 5/16    | 6 15/16   | 10      |
| 6              | 6 5/16         | 7 3/16    | 8 3/4   | 6 1/16    | 7 5/8     | 9 7/8   | 6 1/16    | 7 5/8     | 9 3/4   | 6 1/16    | 7 5/8     | 10 1/2  | 6 5/16    | 7 5/8     | 11 3/8  | 6 5/16    | 7 9/16    | 11 1/8  |
| 8              | 8 1/4          | 9 3/16    | 11      | 8 1/4     | 9 15/16   | 12 1/8  | 8 1/4     | 9 15/16   | 12      | 8 1/4     | 9 15/16   | 12 5/8  | 8 1/4     | 9 15/16   | 14 1/8  | 8 1/4     | 9 3/4     | 13 3/8  |
| 10             | 10 5/16        | 11 7/16   | 13 3/8  | 10 5/16   | 12        | 14 1/4  | 10 5/16   | 12        | 14 1/8  | 10 5/16   | 12        | 15 3/4  | 10 5/16   | 12        | 17 1/8  | 10 1/4    | 11 7/8    | 17 1/8  |
| 12             | 12 3/16        | 13 9/16   | 16 1/8  | 12 3/16   | 14 1/4    | 16 5/8  | 12 3/16   | 14 1/4    | 16 1/2  | 12 3/16   | 14 1/4    | 18      | 12 3/16   | 14 1/4    | 19 9/8  | 11 15/16  | 13 13/16  | 20 1/2  |
| 14             | 13 7/16        | 14 15/16  | 17 3/4  | 14 1/4    | 15 3/4    | 19 1/8  | 14 1/4    | 15 3/4    | 19      | 14 1/4    | 15 3/4    | 19 3/8  | 13 13/16  | 15 5/8    | 20 1/2  | 13 7/16   | 15 3/8    | 22 3/4  |
| 16             | 15 1/2         | 16 15/16  | 20 1/4  | 16 1/4    | 17 3/4    | 21 1/4  | 16 1/4    | 17 3/4    | 21 1/8  | 16 1/4    | 17 3/4    | 22 1/4  | 15 5/16   | 17 9/16   | 22 5/8  | 15        | 17        | 25 1/4  |
| 18             | 17 1/4         | 19        | 21 5/8  | 18 1/4    | 20 1/4    | 23 1/2  | 18 1/4    | 20 1/4    | 23 3/8  | 18 1/4    | 20 1/4    | 24 1/8  | 17 11/16  | 19 5/16   | 25 1/8  | 17 1/4    | 19 1/2    | 27 3/4  |
| 20             | 19 3/4         | 21 1/8    | 23 7/8  | 20 1/4    | 22 3/16   | 25 3/4  | 20 1/4    | 22 3/16   | 25 1/2  | 20 1/4    | 22 3/16   | 26 7/8  | 19 11/16  | 21 5/16   | 27 1/2  | 19 3/16   | 21 7/16   | 29 3/4  |
| 24             | 23 1/2         | 25 1/4    | 28 1/4  | 24 1/4    | 26 5/16   | 30 1/2  | 24 1/4    | 26 5/16   | 30 1/4  | 24 1/4    | 26 5/16   | 31 1/8  | 23 3/16   | 25 5/16   | 33      | 23 1/4    | 25 1/2    | 35 1/2  |

DIMENSIONS IN INCHES.

# STYLE 625 GASKETS

## FOR CLAMP-TYPE AND OTHER NON-STANDARD FLANGE ASSEMBLIES

Style 625 gaskets were originally designed by Flexitallic for clamp-type closures in aircraft, but are now widely used wherever space limitations indicate the need for a wafer-thin or narrow spiral wound gasket.

Style 625 gaskets are manufactured to a nominal thickness of .0625", with compression to .050" - .055".

Style 625 gaskets embody all of the exclusive features of Flexitallic design for keeping compression values in balance with bolting and providing correct resiliency to compensate for variable stresses encountered in service.

Style 625 gaskets can be manufactured from any combination of materials shown on page 7. Please check with Flexitallic for manufacturing limitations on Style 625 gasket larger than 8" I.D. or 3/8" radial width.

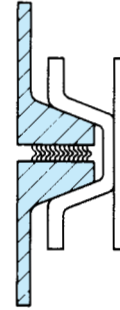

TABLE  
19

| GASKET I.D. (Inches) | GASKET O.D. (Inches) | GASKET IDENTIFICATION NUMBER | ORIGINAL PART NUMBER |
|----------------------|----------------------|------------------------------|----------------------|
| 1 1/8                | 1 5/8                | VC-06-1.00                   | 750244-3             |
| 1 3/8                | 1 7/8                | VC-06-1.25                   | 750244-4             |
| 1 5/8                | 2 1/8                | VC-06-1.50                   | 750244-5             |
| 1 7/8                | 2 3/8                | VC-06-1.75                   | 750244-6             |
| 2 1/8                | 2 5/8                | VC-06-2.00                   | 750244-7             |
| 2 3/8                | 2 7/8                | VC-06-2.25                   | 750244-8             |
| 2 5/8                | 3 1/8                | VC-06-2.50                   | 750244-9             |
| 2 7/8                | 3 3/8                | VC-06-2.75                   | 750244-10            |
| 3 1/8                | 3 5/8                | VC-06-3.00                   | 750244-11            |
| 3 1/4                | 3 3/4                | VC-06-3.15                   | 750244-12            |
| 3 3/8                | 3 7/8                | VC-06-3.25                   | 750244-13            |
| 3 5/8                | 4 1/8                | VC-06-3.50                   | 750244-14            |
| 3 7/8                | 4 3/8                | VC-06-3.75                   | 750244-15            |
| 4 1/8                | 4 5/8                | VC-06-4.00                   | 750244-16            |
| 4 5/8                | 5 1/8                | VC-06-4.50                   | 750244-17            |
| 5 1/8                | 5 5/8                | VC-06-5.00                   | 750244-18            |
| 5 5/8                | 6 1/8                | VC-06-5.50                   | 750244-19            |
| 6 1/8                | 6 5/8                | VC-06-6.00                   | 750244-20            |

DIMENSIONS IN INCHES.

# USEFUL TECHNICAL DATA

## Gasket Style Selection

Ensure that the correct style of gasket has been selected for the appropriate application.

### Note:

Flexitallic recommended Style CG Spiral Wound Gaskets up to and including Class 600 rating.

Style CGI Gaskets should be employed for pressure Classes 900 and above.

All PTFE filled Spiral Wound Gaskets for raised face and flat face flanges should utilize an inner and outer guide ring.

When using Style 'R' Spiral Wound Gaskets ensure that a compression stop is incorporated into the flange arrangement.

## Required Gasket Compression

For optimum sealing performance Flexitallic Spiral Wound Gaskets should be compressed to the following thicknesses:

| INITIAL GASKET THICKNESS | RECOMMENDED COMPRESSED THICKNESS |
|--------------------------|----------------------------------|
| 1.6mm (0.0625in)         | 1.3/1.4mm (0.050in/0.055in)      |
| 2.5mm (0.100in)          | 1.9/2.0mm (0.075in/0.080in)      |
| 3.2mm (0.125in)          | 2.3/2.5mm (0.090in/0.100in)      |
| 4.5mm (0.175in)          | 3.2/3.4mm (0.125in/0.135in)      |
| 6.4mm (0.250in)          | 4.6/5.1mm (0.180in/0.200in)      |
| 7.2mm (0.285in)          | 5.1/5.6mm (0.200in/0.220in)      |

Spiral Wound Gaskets with internal or external guide rings i.e. Style CG and CGI, should be fully compressed to the guide ring. This will not damage the gasket or affect the sealing performance, since the rings are provided as a compression limiting stop.

# USEFUL ASSEMBLY TECHNIQUES

## Flanges

Check that the flange faces are clean, in good condition and with a turned surface finish within the following range Ra 3.2 to 6.3 micro metres (125 to 250 micro inches).

## Bolting

Ensure that the correct bolting material is utilized to suit the operating conditions, taking into account the limitation of low yield strength bolts.

Ensure that the use of bolt lubrication is employed. For torque tightening methods Flexitallic recommends the use of molybdenum disulphide bolt lubrication or similar nickel based compound. Do not apply any lubricants when using PTFE coated fasteners. Consult with the coating manufacturers for product specific friction coefficients.

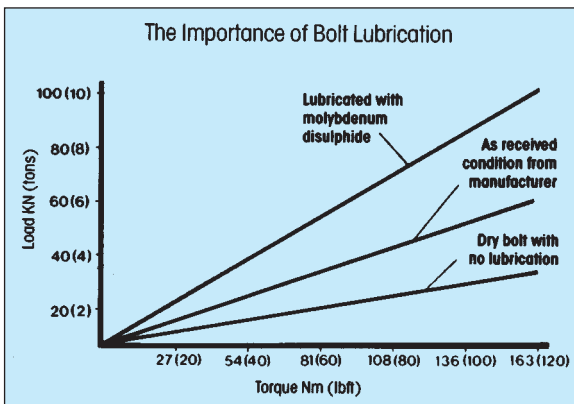
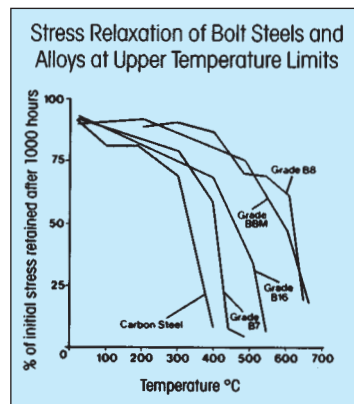

## Tightening Procedures

Controlled tightening procedures should be used when installing spiral wound gaskets. Flexitallic recommends that the use of hydraulic tensioning equipment be considered where possible for bolt diameters 1 1/4" and above.

Please refer to Flexitallic's Design Criteria for further technical information.

# USEFUL TECHNICAL DATA

## TORQUE REQUIRED TO PRODUCE BOLT STRESS

The torque or turning effort required to produce a certain stress in bolting is dependent upon a number of conditions, some of which are:

1. Diameter of bolt.
2. Type and number of threads on bolt.
3. Material of bolt.
4. Condition of nut bearing surfaces.
5. Lubrication of bolt threads and nut bearing surfaces.

Generally, standard Flexitallic spiral wound gaskets will require a minimum of 30,000 psi bolt stress for proper gasket seating. However, it is the users responsibility to follow ASME Code calculations, and to ensure that sufficient pre-load is applied to withstand internal pressure, properly seat the gasket, and compensate for the effects of bolt relaxation.

The table below reflect the results of many tests to determine the relation between torque and bolt stress. Values are based on steel bolting well lubricated with a heavy graphite and oil mixture.

### TORQUE DATA FOR USE WITH ALLOY STEEL STUD BOLTS

#### Load in Pounds on Stud Bolts when Torque Loads are Applied

TABLE  
20

| NOMINAL<br>DIAMETER<br>BOLT<br>(Inches) | NUMBER<br>OF<br>THREADS<br>(Per Inch) | DIAMETER<br>AT ROOT<br>OF THREAD<br>(Inches) | AREA<br>AT ROOT<br>OF THREAD<br>Sq. Inch | STRESS           |                     |                  |                     |                  |                     |
|---|---------------------------------------|--|--|------------------|---------------------|------------------|---------------------|------------------|---------------------|
|   |                                       |  |  | 30,000 PSI       |                     | 45,000 PSI       |                     | 60,000 PSI       |                     |
|   |                                       |  |  | Torque<br>Ft/lbs | Compression<br>lbs. | Torque<br>Ft/lbs | Compression<br>lbs. | Torque<br>Ft/lbs | Compression<br>lbs. |
| 1/4                                     | 20                                    | .185   | .027                                     | 4                | 810                 | 6                | 1215                | 8                | 1620                |
| 5/16                                    | 18                                    | .240   | .045                                     | 8                | 1350                | 12               | 2025                | 16               | 2700                |
| 3/8                                     | 16                                    | .294   | .068                                     | 12               | 2040                | 18               | 3060                | 24               | 4080                |
| 7/16                                    | 14                                    | .345   | .093                                     | 20               | 2790                | 30               | 4185                | 40               | 5580                |
| 1/2                                     | 13                                    | .400   | .126                                     | 30               | 3780                | 45               | 5670                | 60               | 7560                |
| 5/8                                     | 12                                    | .454   | .162                                     | 45               | 4860                | 68               | 7290                | 90               | 9720                |
| 3/4                                     | 11                                    | .507   | .202                                     | 60               | 6060                | 90               | 9090                | 120              | 12120               |
| 7/8                                     | 10                                    | .620   | .302                                     | 100              | 9060                | 150              | 13590               | 200              | 18120               |
| 1                                       | 9                                     | .731   | .419                                     | 160              | 12570               | 240              | 18855               | 320              | 25140               |
| 1 1/8                                   | 8                                     | .838   | .551                                     | 245              | 16530               | 368              | 24795               | 490              | 33060               |
| 1 1/8                                   | 8                                     | .963   | .728                                     | 355              | 21840               | 533              | 32760               | 710              | 43680               |
| 1 1/4                                   | 8                                     | 1.088  | .929                                     | 500              | 27870               | 750              | 41805               | 1000             | 55740               |
| 1 3/8                                   | 8                                     | 1.213  | 1.155                                    | 680              | 34650               | 1020             | 51975               | 1360             | 69300               |
| 1 1/2                                   | 8                                     | 1.338  | 1.405                                    | 800              | 42150               | 1200             | 63225               | 1600             | 84300               |
| 1 5/8                                   | 8                                     | 1.463  | 1.680                                    | 1100             | 50400               | 1650             | 75600               | 2200             | 100800              |
| 1 3/4                                   | 8                                     | 1.588  | 1.980                                    | 1500             | 59400               | 2250             | 89100               | 3000             | 118800              |
| 1 7/8                                   | 8                                     | 1.713  | 2.304                                    | 2000             | 69120               | 3000             | 103680              | 4000             | 138240              |
| 2                                       | 8                                     | 1.838  | 2.652                                    | 2200             | 79560               | 3300             | 119340              | 4400             | 159120              |
| 2 1/4                                   | 8                                     | 2.088  | 3.423                                    | 3180             | 102690              | 4770             | 154035              | 6360             | 205380              |
| 2 1/2                                   | 8                                     | 2.338  | 4.292                                    | 4400             | 128760              | 6600             | 193140              | 8800             | 257520              |
| 2 3/4                                   | 8                                     | 2.588  | 5.259                                    | 5920             | 157770              | 8880             | 236655              | 11840            | 315540              |
| 3                                       | 8                                     | 2.838  | 6.324                                    | 7720             | 189720              | 11580            | 284580              | 15440            | 379440              |

Reprinted with permission of Crane Co. (Page 383, Crane No.60 Valve Catalog.)

# USEFUL TECHNICAL DATA

## BOLTING DATA FOR ASME B16.5 & BS 1560 FLANGES

TABLE 21

| NOMINAL PIPE SIZE | CLASS 150   |              |           |           | CLASS 300   |              |           |           | CLASS 400   |              |           |           | CLASS 600   |              |           |           |
|-------------------|-------------|--------------|-----------|-----------|-------------|--------------|-----------|-----------|-------------|--------------|-----------|-----------|-------------|--------------|-----------|-----------|
|                   | FLANGE DIA. | NO. OF BOLTS | BOLT DIA. | B.C. DIA. | FLANGE DIA. | NO. OF BOLTS | BOLT DIA. | B.C. DIA. | FLANGE DIA. | NO. OF BOLTS | BOLT DIA. | B.C. DIA. | FLANGE DIA. | NO. OF BOLTS | BOLT DIA. | B.C. DIA. |
| 1/4               | 3 3/8       | 4            | 1/2       | 2 1/4     | 3 3/8       | 4            | 1/2       | 2 1/4     | 3 3/8       | 4            | 1/2       | 2 1/4     | 3 3/8       | 4            | 1/2       | 2 1/4     |
| 1/2               | 3 1/2       | 4            | 1/2       | 2 3/8     | 3 3/4       | 4            | 1/2       | 2 5/8     | 3 3/4       | 4            | 1/2       | 2 5/8     | 3 3/4       | 4            | 1/2       | 2 5/8     |
| 3/4               | 3 7/8       | 4            | 1/2       | 2 3/4     | 4 5/8       | 4            | 5/8       | 3 1/4     | 4 5/8       | 4            | 5/8       | 3 1/4     | 4 5/8       | 4            | 5/8       | 3 1/4     |
| 1                 | 4 1/4       | 4            | 1/2       | 3 1/8     | 4 7/8       | 4            | 5/8       | 3 1/2     | 4 7/8       | 4            | 5/8       | 3 1/2     | 4 7/8       | 4            | 5/8       | 3 1/2     |
| 1 1/4             | 4 5/8       | 4            | 1/2       | 3 1/2     | 5 1/4       | 4            | 5/8       | 3 7/8     | 5 1/4       | 4            | 5/8       | 3 7/8     | 5 1/4       | 4            | 5/8       | 3 7/8     |
| 1 1/2             | 5           | 4            | 1/2       | 3 7/8     | 6 1/8       | 4            | 3/4       | 4 1/2     | 6 1/8       | 4            | 3/4       | 4 1/2     | 6 1/8       | 4            | 3/4       | 4 1/2     |
| 2                 | 6           | 4            | 5/8       | 4 3/4     | 6 1/2       | 8            | 5/8       | 5         | 6 1/2       | 8            | 5/8       | 5         | 6 1/2       | 8            | 5/8       | 5         |
| 2 1/2             | 7           | 4            | 5/8       | 5 1/2     | 7 1/2       | 8            | 3/4       | 5 7/8     | 7 1/2       | 8            | 3/4       | 5 7/8     | 7 1/2       | 8            | 3/4       | 5 7/8     |
| 3                 | 7 1/2       | 4            | 5/8       | 6         | 8 1/4       | 8            | 3/4       | 6 5/8     | 8 1/4       | 8            | 3/4       | 6 5/8     | 8 1/4       | 8            | 3/4       | 6 5/8     |
| 3 1/2             | 8 1/2       | 8            | 5/8       | 7         | 9           | 8            | 3/4       | 7 1/4     | 9           | 8            | 7/8       | 7 1/4     | 9           | 8            | 7/8       | 7 1/4     |
| 4                 | 9           | 8            | 5/8       | 7 1/2     | 10          | 8            | 3/4       | 7 7/8     | 10          | 8            | 7/8       | 7 7/8     | 10 3/4      | 8            | 7/8       | 8 1/2     |
| 5                 | 10          | 8            | 3/4       | 8 1/2     | 11          | 8            | 3/4       | 9 1/4     | 11          | 8            | 7/8       | 9 1/4     | 13          | 8            | 1         | 10 1/2    |
| 6                 | 11          | 8            | 3/4       | 9 1/2     | 12 1/2      | 12           | 3/4       | 10 5/8    | 12 1/2      | 12           | 7/8       | 10 5/8    | 14          | 12           | 1         | 11 1/2    |
| 8                 | 13 1/2      | 8            | 3/4       | 11 3/4    | 15          | 12           | 7/8       | 13        | 15          | 12           | 1         | 13        | 16 1/2      | 12           | 1 1/8     | 13 3/4    |
| 10                | 16          | 12           | 7/8       | 14 1/4    | 17 1/2      | 16           | 1         | 15 1/4    | 17 1/2      | 16           | 1 1/8     | 15 1/4    | 20          | 16           | 1 1/4     | 17        |
| 12                | 19          | 12           | 7/8       | 17        | 20 1/2      | 16           | 1 1/8     | 17 3/4    | 20 1/2      | 16           | 1 1/4     | 17 3/4    | 22          | 20           | 1 1/4     | 19 1/4    |
| 14                | 21          | 12           | 1         | 18 3/4    | 23          | 20           | 1 1/8     | 20 1/4    | 23          | 20           | 1 1/4     | 20 1/4    | 23 3/4      | 20           | 1 3/8     | 20 3/4    |
| 16                | 23 1/2      | 16           | 1         | 21 1/4    | 25 1/2      | 20           | 1 1/4     | 22 1/2    | 25 1/2      | 20           | 1 3/8     | 22 1/2    | 27          | 20           | 1 1/2     | 23 3/4    |
| 18                | 25          | 16           | 1 1/8     | 22 3/4    | 28          | 24           | 1 1/4     | 24 3/4    | 28          | 24           | 1 3/8     | 24 3/4    | 29 1/4      | 20           | 1 5/8     | 25 3/4    |
| 20                | 27 1/2      | 20           | 1 1/8     | 25        | 30 1/2      | 24           | 1 1/4     | 27        | 30 1/2      | 24           | 1 1/2     | 27        | 32          | 24           | 1 5/8     | 28 1/2    |
| 24                | 32          | 20           | 1 1/4     | 29 1/2    | 36          | 24           | 1 1/2     | 32        | 36          | 24           | 1 3/4     | 32        | 37          | 24           | 1 7/8     | 33        |

DIMENSIONS IN INCHES

TABLE 22

| NOMINAL PIPE SIZE | CLASS 900   |              |           |           | CLASS 1500  |              |           |           | CLASS 2500  |              |           |           |
|-------------------|-------------|--------------|-----------|-----------|-------------|--------------|-----------|-----------|-------------|--------------|-----------|-----------|
|                   | FLANGE DIA. | NO. OF BOLTS | BOLT DIA. | B.C. DIA. | FLANGE DIA. | NO. OF BOLTS | BOLT DIA. | B.C. DIA. | FLANGE DIA. | NO. OF BOLTS | BOLT DIA. | B.C. DIA. |
| 1/2               | 4 3/4       | 4            | 3/4       | 3 1/4     | 4 3/4       | 4            | 3/4       | 3 1/4     | 5 1/4       | 4            | 3/4       | 3 1/2     |
| 3/4               | 5 1/8       | 4            | 3/4       | 3 1/2     | 5 1/8       | 4            | 3/4       | 3 1/2     | 5 1/2       | 4            | 3/4       | 3 3/4     |
| 1                 | 5 7/8       | 4            | 7/8       | 4         | 5 7/8       | 4            | 7/8       | 4         | 6 1/4       | 4            | 7/8       | 4 1/4     |
| 1 1/4             | 6 1/4       | 4            | 7/8       | 4 3/8     | 6 1/4       | 4            | 7/8       | 4 3/8     | 7 1/4       | 4            | 1         | 5 1/8     |
| 1 1/2             | 7           | 4            | 1         | 4 7/8     | 7           | 4            | 1         | 4 7/8     | 8           | 4            | 1 1/8     | 5 3/4     |
| 2                 | 8 1/2       | 8            | 7/8       | 6 1/2     | 8 1/2       | 8            | 7/8       | 6 1/2     | 9 1/4       | 8            | 1         | 6 3/4     |
| 2 1/2             | 9 5/8       | 8            | 1         | 7 1/2     | 9 5/8       | 8            | 1         | 7 1/2     | 10 1/2      | 8            | 1 1/8     | 7 3/4     |
| 3                 | 9 1/2       | 8            | 7/8       | 7 1/2     | 10 1/2      | 8            | 1 1/8     | 8         | 12          | 8            | 1 1/4     | 9         |
| 4                 | 11 1/2      | 8            | 1 1/8     | 9 1/4     | 12 1/4      | 8            | 1 1/4     | 9 1/2     | 14          | 8            | 1 1/2     | 10 3/4    |
| 5                 | 13 3/4      | 8            | 1 1/4     | 11        | 14 3/4      | 8            | 1 1/2     | 11 1/2    | 16 1/2      | 8            | 1 3/4     | 12 3/4    |
| 6                 | 15          | 12           | 1 1/8     | 12 1/2    | 15 1/2      | 12           | 1 3/8     | 12 1/2    | 19          | 8            | 2         | 14 1/2    |
| 8                 | 18 1/2      | 12           | 1 3/8     | 15 1/2    | 19          | 12           | 1 5/8     | 15 1/2    | 21 3/4      | 12           | 2         | 17 1/4    |
| 10                | 21 1/2      | 16           | 1 3/8     | 18 1/2    | 23          | 12           | 1 7/8     | 19        | 26 1/2      | 12           | 2 1/2     | 21 1/4    |
| 12                | 24          | 20           | 1 3/8     | 21        | 26 1/2      | 16           | 2         | 22 1/2    | 30          | 12           | 2 3/4     | 24 3/8    |
| 14                | 25 1/4      | 20           | 1 1/2     | 22        | 29 1/2      | 16           | 2 1/4     | 25        | -           | -            | -         | -         |
| 16                | 27 3/4      | 20           | 1 5/8     | 24 1/4    | 32 1/2      | 16           | 2 1/2     | 27 3/4    | -           | -            | -         | -         |
| 18                | 31          | 20           | 1 7/8     | 27        | 36          | 16           | 2 3/4     | 30 1/2    | -           | -            | -         | -         |
| 20                | 33 3/4      | 20           | 2         | 29 1/2    | 38 3/4      | 16           | 3         | 32 3/4    | -           | -            | -         | -         |
| 24                | 41          | 20           | 2 1/2     | 35 1/2    | 46          | 16           | 3 1/2     | 39        | -           | -            | -         | -         |

DIMENSIONS IN INCHES

# USEFUL TECHNICAL DATA

## FACING DIMENSIONS FOR ASME B16.5 & BS 1560 FLANGES

CLASS 150, 300, 400, 600, 900, 1500 AND 2500

TABLE  
23

| NOMINAL<br>PIPE<br>SIZE | OUTSIDE DIAMETER See Note 3   |  |                                    |   | I.D. OF<br>LARGE<br>& SMALL<br>TONGUE<br>See Notes<br>3 & 5<br>U | OUTSIDE DIAMETER See Note 3                      |                                    |   | I.D. OF<br>LARGE &<br>SMALL<br>GROOVE<br>See Note 3<br>See Note 5<br>Z | HEIGHT  |      | DEPTH OF<br>GROOVE OR<br>FEMALE |
|-------------------------|---|--|------------------------------------|---|--|--|------------------------------------|---|--|---|------|---------------------------------|
|                         | RAISED FACE,<br>LAPPED,<br>LARGE MALE,<br>& LARGE<br>TONGUES<br>See Note 5<br>R | SMALL<br>MALE<br>See Notes<br>4&5<br>S | SMALL<br>TONGUE<br>See Note 5<br>T | LARGE<br>FEMALE &<br>LARGE<br>GROOVE<br>See Note 5<br>w |  | SMALL<br>FEMALE<br>See Note 4<br>See Note 5<br>X | SMALL<br>GROOVE<br>See Note 5<br>V | RAISED FACE<br>CLASS<br>150 & 300<br>See Note 1 |  | RAISED FACE<br>LARGE &<br>SMALL MALE<br>& TONGUE<br>CLASS<br>400, 600, 900<br>1500 & 2500<br>See Note 2 |      |                                 |
|                         |   |  |                                    |   |  |  |                                    |   |  |   |      |                                 |
| 1/2                     | 1 3/8   | 22/32                                  | 1 3/8                              | 1   | 1 7/16   | 25/32  | 1 7/16                             | 1 5/16  | 1/16   | 1/4   | 3/16 |                                 |
| 3/4                     | 1 11/16   | 15/16                                  | 1 11/16                            | 1 5/16  | 1 3/4  | 1  | 1 3/4                              | 1 1/4   | 1/16   | 1/4   | 3/16 |                                 |
| 1                       | 2   | 1 3/16                                 | 1 7/8                              | 1 1/2   | 2 1/16   | 1 1/4  | 1 15/16                            | 1 7/16  | 1/16   | 1/4   | 3/16 |                                 |
| 1 1/4                   | 2 1/2   | 1 1/2                                  | 2 1/4                              | 1 7/8   | 2 9/16   | 1 9/16   | 2 5/16                             | 1 13/16   | 1/16   | 1/4   | 3/16 |                                 |
| 1 1/2                   | 2 7/8   | 1 3/4                                  | 2 1/2                              | 2 1/8   | 2 15/16  | 1 13/16  | 2 9/16                             | 2 1/16  | 1/16   | 1/4   | 3/16 |                                 |
| 2                       | 3 5/8   | 2 1/4                                  | 3 1/4                              | 2 7/8   | 3 11/16  | 2 5/16   | 3 5/16                             | 2 13/16   | 1/16   | 1/4   | 3/16 |                                 |
| 2 1/2                   | 4 1/8   | 2 11/16                                | 3 3/4                              | 3 3/8   | 4 3/16   | 2 3/4  | 3 13/16                            | 3 5/16  | 1/16   | 1/4   | 3/16 |                                 |
| 3                       | 5   | 3 5/16                                 | 4 5/8                              | 4 1/4   | 5 1/16   | 3 3/8  | 4 11/16                            | 4 3/16  | 1/16   | 1/4   | 3/16 |                                 |
| 3 1/2                   | 5 1/2   | 3 13/16                                | 5 1/8                              | 4 3/4   | 5 9/16   | 3 7/8  | 5 3/16                             | 4 11/16   | 1/16   | 1/4   | 3/16 |                                 |
| 4                       | 6 3/16  | 4 5/16                                 | 5 11/16                            | 5 3/16  | 6 1/4  | 4 3/8  | 5 3/4                              | 5 5/8   | 1/16   | 1/4   | 3/16 |                                 |
| 5                       | 7 5/16  | 5 3/8                                  | 6 13/16                            | 6 5/16  | 7 3/8  | 5 7/16   | 6 7/8                              | 6 1/4   | 1/16   | 1/4   | 3/16 |                                 |
| 6                       | 8 1/2   | 6 3/8                                  | 8                                  | 7 1/2   | 8 9/16   | 6 7/16   | 8 1/16                             | 7 7/16  | 1/16   | 1/4   | 3/16 |                                 |
| 8                       | 10 5/8  | 8 3/8                                  | 10                                 | 9 3/8   | 10 11/16   | 8 7/16   | 10 1/16                            | 9 5/16  | 1/16   | 1/4   | 3/16 |                                 |
| 10                      | 12 3/4  | 10 1/2                                 | 12                                 | 11 1/4  | 12 13/16   | 10 9/16  | 12 1/16                            | 11 3/16   | 1/16   | 1/4   | 3/16 |                                 |
| 12                      | 15  | 12 1/2                                 | 14 1/4                             | 13 1/2  | 15 1/16  | 12 9/16  | 14 5/16                            | 13 7/16   | 1/16   | 1/4   | 3/16 |                                 |
| 14                      | 16 1/4  | 13 3/4                                 | 15 1/2                             | 14 3/4  | 16 5/16  | 13 13/16   | 15 9/16                            | 14 11/16  | 1/16   | 1/4   | 3/16 |                                 |
| 16                      | 18 1/2  | 15 3/4                                 | 17 5/8                             | 16 3/4  | 18 9/16  | 15 13/16   | 17 11/16                           | 16 11/16  | 1/16   | 1/4   | 3/16 |                                 |
| 18                      | 21  | 17 3/4                                 | 20 1/8                             | 19 1/4  | 21 1/16  | 17 13/16   | 20 3/16                            | 19 3/16   | 1/16   | 1/4   | 3/16 |                                 |
| 20                      | 23  | 19 3/4                                 | 22                                 | 21  | 23 1/16  | 19 13/16   | 22 1/16                            | 20 15/16  | 1/16   | 1/4   | 3/16 |                                 |
| 24                      | 27 1/4  | 23 3/4                                 | 26 1/4                             | 25 1/4  | 27 5/16  | 23 13/16   | 26 5/16                            | 25 3/16   | 1/16   | 1/4   | 3/16 |                                 |

DIMENSIONS IN INCHES

### NOTES

- Regular facing for class 150 and 300 steel flanged fittings and companion flange standards is a 1/16" raised face included in the minimum flange thickness dimensions. A 3/16" raised face may be supplied also on the class 400, 600, 900, 1500, and 2500 flange standards, but it must be added to the minimum flange thickness.
- Regular facing for class 400, 600, 900, 1500, and 2500 flange thickness dimensions.
- Tolerance of plus or minus 0.016 in. 1/64" is allowed on the inside and outside diameters of all facings.
- For small male and female joints care should be taken in the use of these dimensions to insure that pipe used is thick enough to permit sufficient bearing surface to prevent the crushing of the gasket. The dimensions apply particularly on lines where the joint is made on the end of the pipe. Screwed companion flanges for small male and female joints are furnished with plain face and are threaded with American Standard Locknut Thread.
- Gaskets for male-female and tongue-groove joints shall cover the bottom of the recess with minimum clearances taking into account the tolerances prescribed in Note 3.

# SPECIAL HEAT EXCHANGER GASKETS

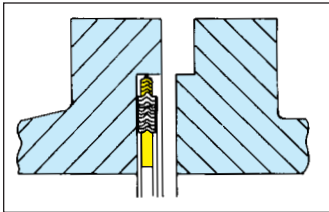
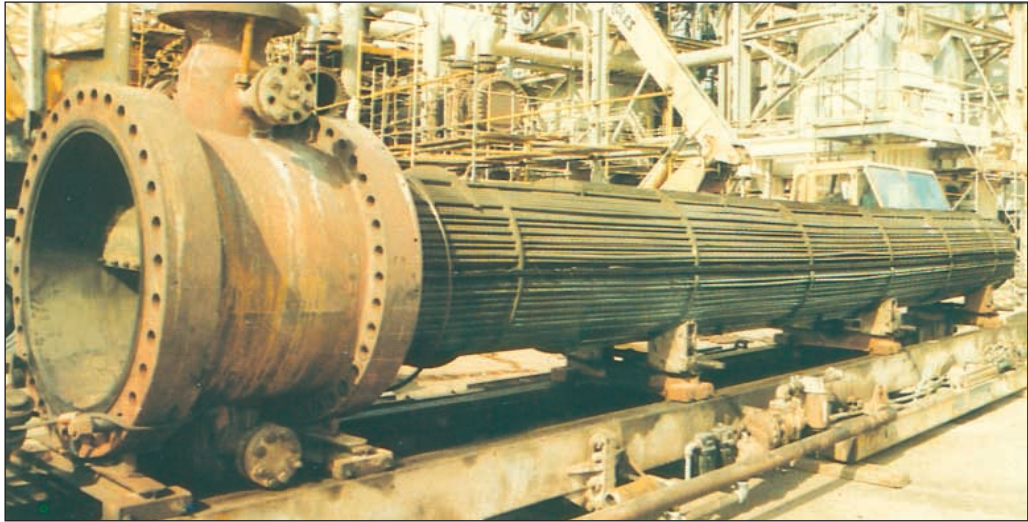

## Special HE-CGI Gaskets with spiral wound outer ring (ALTERNATIVES HE-CG, HE-CGI)

Flexitallic special HE-CGI Gaskets with spiral wound outer ring are primarily designed for TEMA male and female flanges and are custom built to suit the design conditions of individual heat exchanger vessels. These gaskets are available in an extensive range of materials.

*This style incorporates several special features, as follows:*

1. The outer wound nose to ensure correct sealing element location in the flange recess.
2. A spiral wound sealing element to ensure a positive seal under fluctuating temperature and pressure conditions.
3. A solid metal inner ring to protect the sealing element and act as a compression stop. As an optional extra, inner rings can also be supplied with nylon location screws to secure the gasket to the flange on assembly.
4. Can be supplied with pass partition bars in any configuration. Pass bars are secured to the inner ring and can be supplied in either solid metal or double jacketed construction.

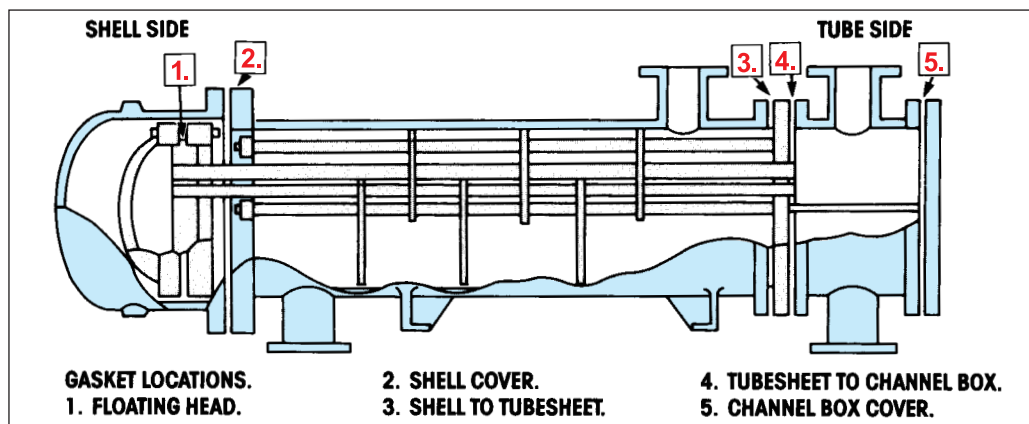
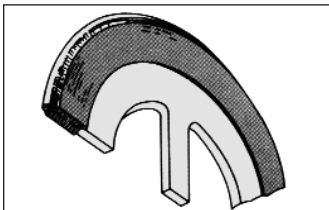
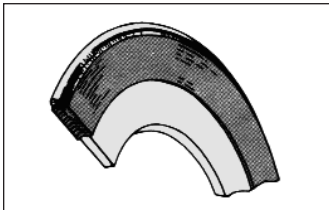

Heat exchangers with flat face or raised face flanges should utilize style CG and CGI spiral wound gaskets.

# CARRIER RING GASKETS

The carrier ring concept consists of a solid metal ring with a machined recess in each face. Spiral wound gaskets are then located in each of the machined recesses.

This type of arrangement has been successfully used in sealing problematic flanges and vessels in the nuclear, power and petrochemical industries. The major benefits of the carrier ring assembly are due to the double spiral wound gasket being present. This results in a very high recovery gasket, ensuring that the bolt load is maintained on the sealing elements when arduous pressure/temperature cycling occurs in service, thus maintaining a seal.

Carrier rings can be used on flat face, raised face or tongue and groove type flange,

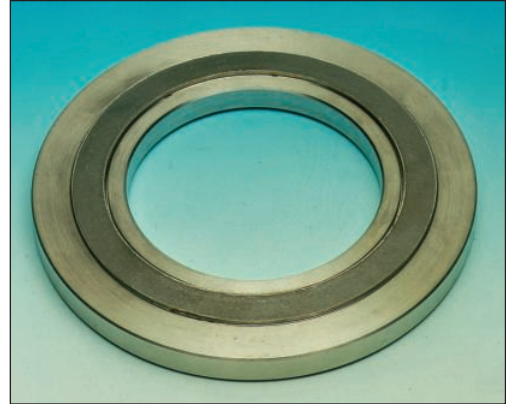

as well as non standard flange configurations. They can be supplied for both small and large diameter nominal bores up to class 2500 pressure rating. Carrier rings are also tailor made to suit specific flange arrangements and design conditions.



## Typical Applications

The carrier ring concept has been extensively used in the power generation industries, petrochemical and nuclear industries. Typical applications are as follows:

Heat Exchanger  
Operating Pressure: 2900 psi  
Temperature: 200°C  
Tube Sheet

H.P. Heaters, Fossil Fired Generators,  
H.O.T. Construction, Steam Service  
Operating Pressure: 700 psi  
Temperature: 370°C

Materials Utilized  
316L/Flexicarb®  
17-7PH/Flexicarb®  
Inc X750 HT (Special high recovery material)

Catalytic Crackers  
720°C, Regenerators, 2980 mm OD  
Hydrocarbon Service, Refineries

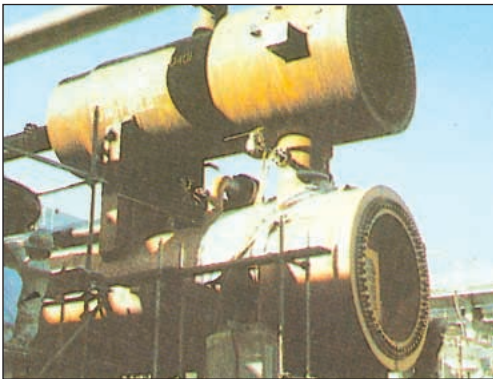

# STYLE LS™ & LSI LOW STRESS RANGE OF SPIRAL WOUND GASKETS

The LS gasket offers the same high integrity seal associated with the spiral wound gasket however, the LS and LSI has been designed in such a way that compression and sealing requirements are achieved under very low seating stresses. These gaskets are intended for use on class 150 and 300 applications, where customers traditionally do not use spiral wound gaskets due to concerns about exceeding allowable design stresses.

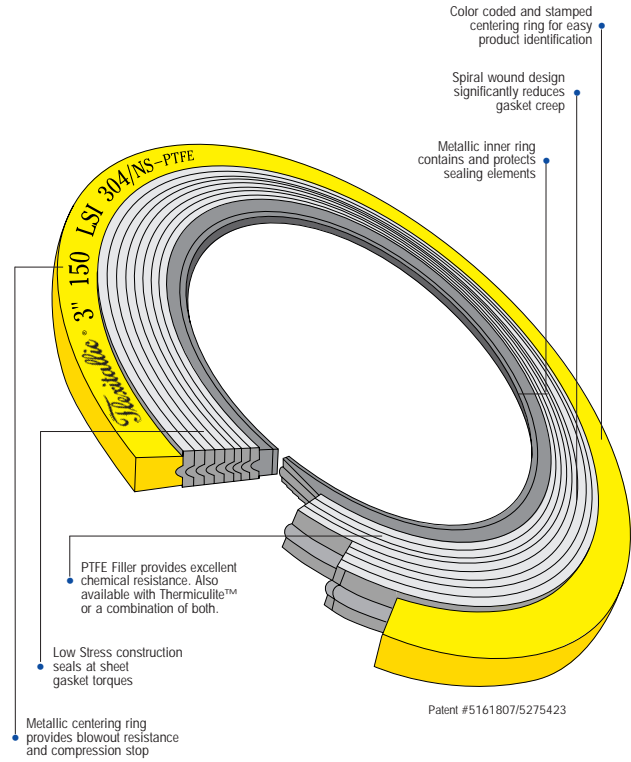
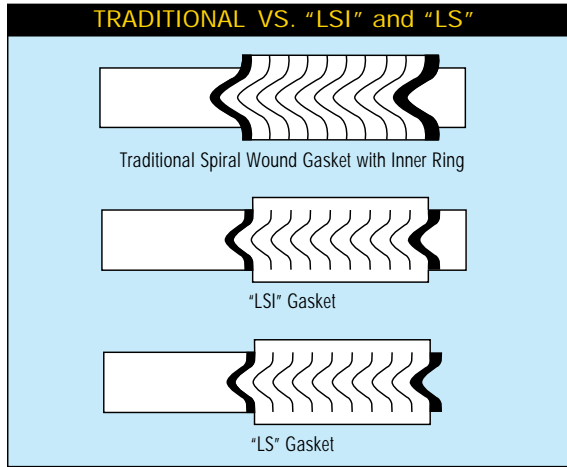

The traditional spiral wound gasket has its steel windings protruding above the compression stop; this requires a significant loading stress to compress the gasket to its optimum operating thickness. The LS and LSI gaskets have only soft Flexicarb or PTFE filler protruding above metal windings and guide ring; therefore as the gasket is compressed, the Flexicarb®, Thermiculite™ 836, or PTFE filler is readily compressed thus producing the sealing mechanism at an earlier stage as compared to the conventionally manufactured spiral-wound gasket.

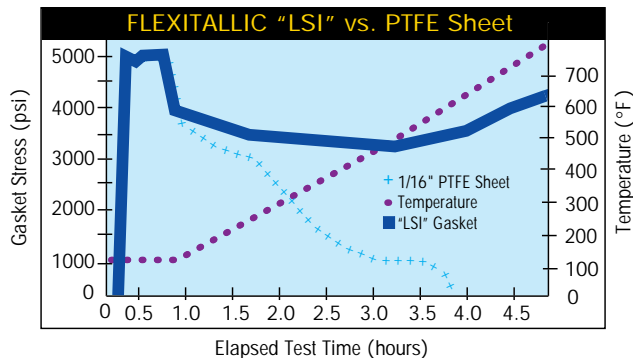

The "LSI" gasket retains more of its initial stress or tightness, even when subjected to high temperatures, unlike PTFE sheet gaskets.

AVAILABLE IN A VARIETY OF METALS,  
ENGINEERED TO SUIT SPECIFIC APPLICATIONS.

## LOWER BOLT STRESS-REDUCED FUGITIVE EMISSIONS

Flexitallic recommended minimum bolt torque figures for use with the "LSI" gasket on ASME/B16.5 flanges.\*

| NPS (Ins) | TORQUE FT. LBS. | NPS (Ins) | TORQUE FT. LBS. |
|-----------|-----------------|-----------|-----------------|
| 1/2       | 25              | 5         | 83              |
| 3/4       | 25              | 6         | 83              |
| 1         | 25              | 8         | 83              |
| 1 1/4     | 25              | 10        | 133             |
| 1 1/2     | 25              | 12        | 133             |
| 2         | 50              | 14        | 204             |
| 2 1/2     | 50              | 16        | 204             |
| 3         | 50              | 18        | 296             |
| 3 1/2     | 50              | 20        | 296             |
| 4         | 50              | 24        | 417             |

Note: Minimum required torques may be even lower depending on gasket size and bolt material. Please contact Flexitallic's Technical Services Department for more information.

\*Above torque values are for class 150 ASME flanges  
TORQUE VALVES FOR 300 # AVAILABLE ON REQUEST.

# SPIRAL WOUND GASKETS FOR BOILER CAP AND MANHOLE COVER ASSEMBLIES

Gaskets for boiler handhole, tubecap and manhole covers incorporating the unique Flexitallic spiral wound profile and specially manufactured with Flexicarb® filler, are ideal for corrosive, high pressure or temperature duties. Flexitallic's anticipation of developments in modern steam generating and engineering equipment and ability to design to specific requirements are the guarantee of the perfect seal at minimum maintenance cost with consistently high standards of performance.

- High safety factor related to specific operating conditions
- Compression loadings proportional to safe stresses of cover assemblies
- Resilient under concentrated and fluctuating loads
- Prolonged trouble-free service
- Reduced seat cleaning time

## Style M & MC & MCS

Spiral Wound Gaskets for Boiler Manhole Cover Assemblies

The Flexitallic manhole gasket spiral constructions incorporate modified compression values to provide seating loads within the normal range of cover assemblies.

### Size/Range Specification

Available in circular, obround, and oval shapes to suit standard manhole plate configurations.



Style M Gaskets



Style MC Gaskets

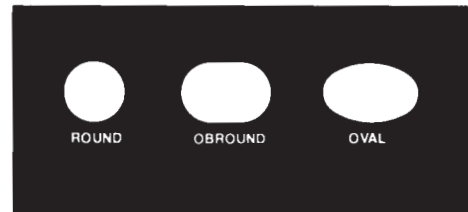

Standard Style M

## Style T

Spiral Wound Gaskets for Boiler Handhole and Tubecap Assemblies

The design features of the basic Flexitallic spiral wound construction alleviate the need for sealing compound. Particularly suitable where old and pitted faces have rendered other gaskets ineffective.

### Size/Range Specification

Available in several standard shapes:-



Basic spiral construction of Style T Gaskets

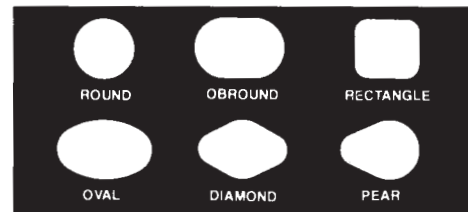

Style T Pear

Supplied in thicknesses of 3.2mm (0.125in.) or 4.5mm (0.175 in.). The standard thickness of 4.5mm (0.175in.) is recommended for use in assemblies where the seat is relatively broad and bolting load is low.

## Materials

Standard materials are Type 304 Stainless Steel and Flexicarb windings. Special materials to suit specific operating conditions are available.

## To Order

With all orders or inquiries please submit following:

- Name of boiler or equipment manufacturer
- Gasket style
- Dimensions of gasket
- Gasket thickness
- Flange width of gasket
- Pressure service rating
- Gasket material preference

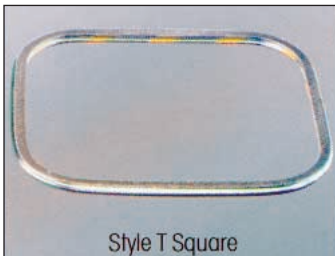

Style T Square

## STYLES M & MC FOR MANHOLE COVER ASSEMBLIES

TABLE  
24

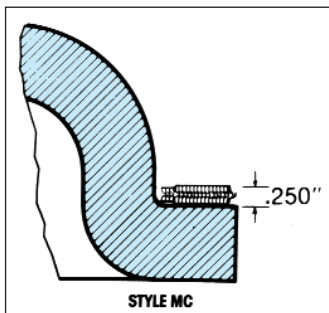
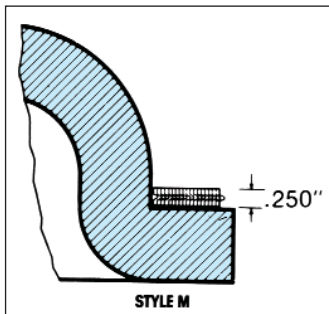
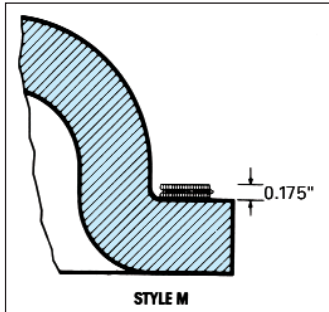

| STYLE    | NOMINAL I.D. DIMENSIONS (inches)                                  | THICKNESS (inches) | FLANGE WIDTH (inches)         |
|----------|---|--------------------|-------------------------------|
| M-Oval   | 10 x 15   | .250               | <sup>15</sup> / <sub>16</sub> |
| M-Oval   | 10 x 16   | .250               | <sup>15</sup> / <sub>16</sub> |
| M-Oval   | 11 x 15   | .250               | <sup>15</sup> / <sub>16</sub> |
| MC-Oval  | 11 x 15   | .250               | <sup>13</sup> / <sub>16</sub> |
| M-Oval   | 11 x 15   | .175               | <sup>3</sup> / <sub>4</sub>   |
| M-Oval   | 11 x 15   | .175               | <sup>15</sup> / <sub>16</sub> |
| M-Oval   | 11 x 15   | .175               | <sup>1</sup> / <sub>2</sub>   |
| M-Oval   | 11 x 15   | .175               | 1 <sup>1</sup> / <sub>4</sub> |
| M-Oval   | 11 x 15   | .250               | 1 <sup>1</sup> / <sub>4</sub> |
| M-Oround | 11 <sup>1</sup> / <sub>16</sub> x 14 <sup>7</sup> / <sub>8</sub>  | .250               | <sup>15</sup> / <sub>16</sub> |
| M-Oround | 11 <sup>1</sup> / <sub>16</sub> x 15 <sup>1</sup> / <sub>16</sub> | .250               | <sup>15</sup> / <sub>16</sub> |
| M-Oval   | 12 x 16   | .250               | <sup>15</sup> / <sub>16</sub> |
| MC-Oval  | 12 x 16   | .250               | <sup>13</sup> / <sub>16</sub> |
| MOval    | 12 x 16   | .175               | <sup>1</sup> / <sub>2</sub>   |
| M-Oval   | 12 x 16   | .175               | <sup>3</sup> / <sub>4</sub>   |
| M-Oval   | 12 x 16   | .175               | <sup>15</sup> / <sub>16</sub> |
| M-Oval   | 12 x 16   | .175               | 1 <sup>1</sup> / <sub>4</sub> |
| M-Oval   | 12 x 16   | .250               | 1 <sup>1</sup> / <sub>4</sub> |
| M-Oround | 12 x 16   | .250               | <sup>15</sup> / <sub>16</sub> |
| M-Oround | 12 x 16   | .250               | 1 <sup>1</sup> / <sub>4</sub> |
| MC-Oval  | 12 <sup>7</sup> / <sub>8</sub> x 16 <sup>7</sup> / <sub>8</sub>   | .250               | <sup>13</sup> / <sub>16</sub> |
| M-Oround | 14 x 16   | .175               | <sup>3</sup> / <sub>4</sub>   |
| M-Round  | 14  | .175               | <sup>3</sup> / <sub>4</sub>   |
| M-Round  | 16 <sup>1</sup> / <sub>16</sub>                                   | .175               | <sup>3</sup> / <sub>4</sub>   |

NOTE: When ordering gaskets specify operating pressure and temperature and type of steel desired.

## FLEXITALLIC STYLE MCS SPIRAL WOUND GASKETS

In keeping with our tradition of taking a leadership role in the gasket industry we are pleased to introduce the Flexitallic style MCS spiral wound gasket for use on boiler manhole cover assemblies. The style MCS gasket is an exclusive Flexitallic design, consisting of a Flexitallic spiral wound gasket with an integral solid metal inner and/or outer ring. The spiral wound sealing element provides resilience, strength, blowout resistance and superior sealability. The solid metal rings prevent over-compression of the gasket, which is especially important on high pressure boilers. In addition, the rings provide stability and facilitate proper positioning of the gasket on the cover which prevents pinching, shouldering, and other gasket damage resulting from misalignment, irregular plate contours and fillets.

Flexitallic style MCS spiral wound gaskets are available in a wide range of materials for standard, as well as special design manhole cover assemblies, in pressure classes of 0-499 psi, 0-999 psi, and 1000 psi and higher. For additional information on Flexitallic style MCS spiral wound gaskets, contact the Flexitallic plant nearest you.

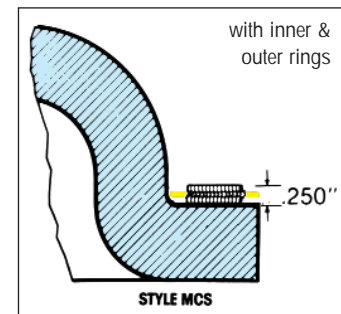
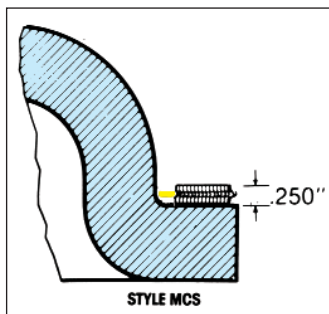



# THE BAKER\*GASKET

## FOR HF ACID & OTHER HAZARDOUS CHEMICAL APPLICATIONS

### Problem

A leak occurs on HF service

- HF can attack the bolts causing bolt failure.
- A small emission goes undetected.

### Solution

- Prevents HF attacking the bolts.
- Early detection of small leaks.
- Containment of HF emissions.
- Improves maintenance (detect & repair).
- Requires no modification to the flanges.
- Designed to suit Class 150 & 300 flanges.
- Contains no respirable fibers.

### What are the benefits?

The Baker gasket offers the user the reliability of a spiral wound gasket with the additional back-up of an emissions containment system should a leak occur. Reduced maintenance costs through an improved 'Detect & Repair' program. Improvements in plant operators Health & Safety profile.

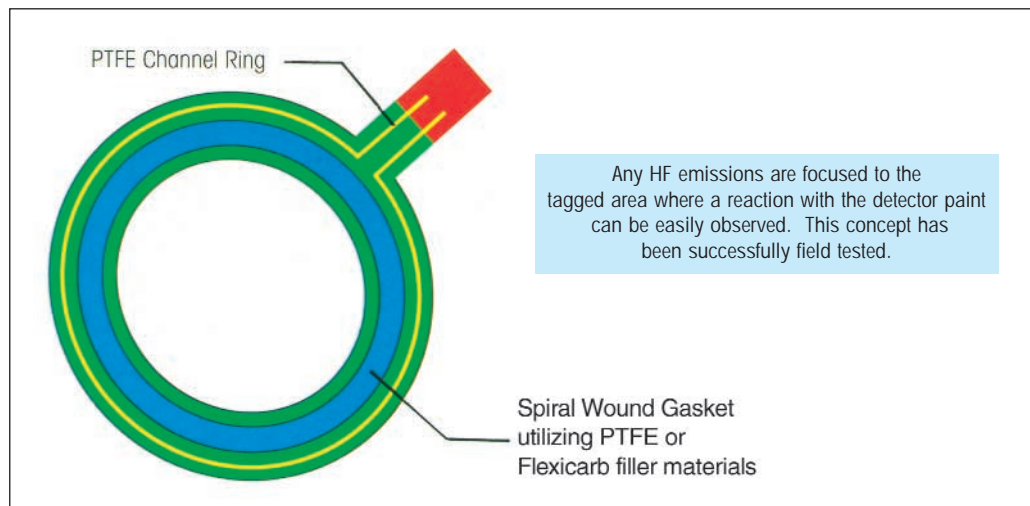
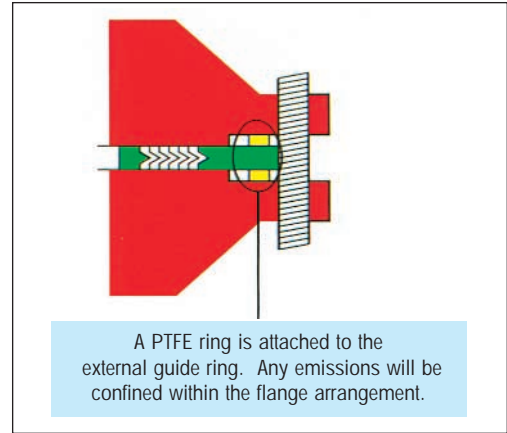
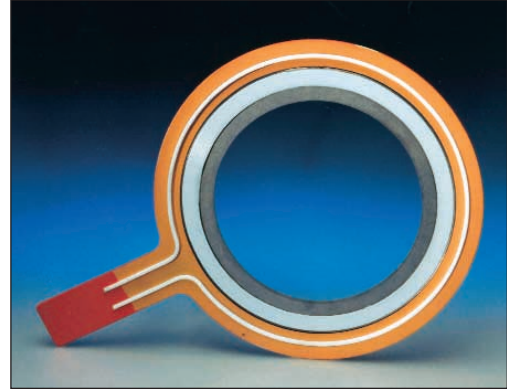

\*Patent Pending

## Multi-Class Spiral Wound Gasket

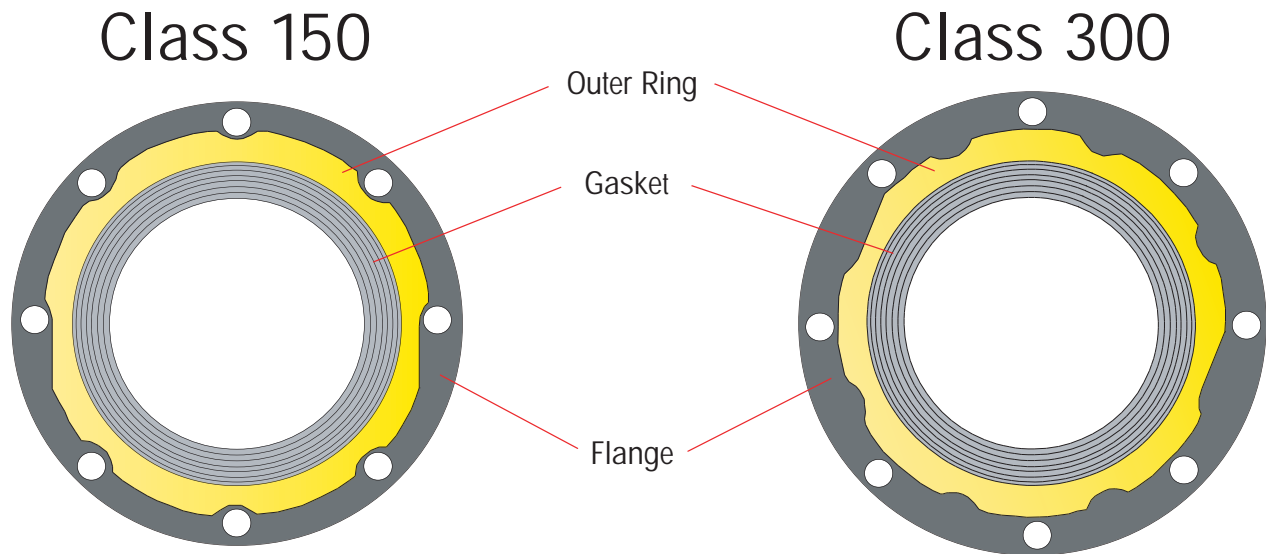

- One gasket accommodates both Class 150 and 300 flanges (Class 150 to 600 in NPS 1/2 through NPS 3)
- Reduces inventory requirements
- Easy to install... Less than half the studs
- Multiple metal windings & fillers available
- Also available with inner rings