

NIPPLES

FITTINGS AND NIPPLES

NIPPLES & FITTINGS**BRASS & BRONZE**

Brass Nipples - Sch 40
 C/P Brass Nipples
 Bronze Fittings
 Lead Free Bronze Fittings
 C/P Fittings
 Bronze Drop Ear Elbows
 Bronze Barbs for PL. Pipe
 Steel Barbs for PL. Pipe
 Lead Free Bronze Barbs for PL. Pipe
 Stainless Steel Barbs for PL. Pipe
 Stainless Steel Well Couplings
 Stainless Steel Merchant Couplings

STAINLESS STEEL

Stainless Nipples
 150# Cast SS Fittings

BLACK & GALVANIZED

Sch. 40 Welded Steel Nipples
 Single Run
 Nipple Assortments
 Sch. 80 Seamless Steel nipple
 Sch. XXS Seamless Steel Nipple
 Groove Nipples
 Merchant Couplings
 API Line Couplings
 Malleable Fittings
 Steel Fittings
 300# Malleable
 Bull Plugs and Swages
 Forged Steel Fanges
 Companion Flanges
 Blind Flanges

WARNING: This product can expose you to chemicals, including Nickel, which are known to the State of California to cause cancer.
 For more information, visit www.P65Warnings.ca.gov



BRASS NIPPLES



We hereby certify that to the best of our knowledge and belief the CDA 230 alloy seamless Red Brass Pipe from which our nipples are produced meet the requirements of ASTM Specifications B43 and is free of mercury contamination. The chemical analysis is 85% copper, 15% Zinc and conforms to federal Specifications WWN-351. Our brass nipples meet ANSI/ASTM B687-96 and MS51846 for standard brass nipples, and MS51872 for extra heavy brass nipples.

Threads: Nipples are threaded with American Standard taper pipe threads (NPT) in accordance with screw-thread standard for Federal Services Handbook H-58. ANSI B1.20.1

This product is certified by NSF to NSF/ANSI 61 for use in drinking water supplies of pH 6.5 and above.

- ASTM B43
- ANSI B1.20.1, WW-N-351
- ANSI/ ASTM B687-96
- NSF-61 Approved
- MS51846 STD Brass Nipples
- RoHS compliant

SEE OUR WEBSITE FOR EXTRA HEAVY BRASS NIPPLES AND EXTRA HEAVY BRONZE FITTINGS

STANDARD RED BRASS 85% PIPE WITH THREADED ENDS SPECIFICATIONS:			
PIPE SIZE IN INCHES	DIMENSION IN INCHES		
	O.D.	I.D.	WALL THICKNESS
1/8"	.405	.281	.062
1/4"	.540	.376	.082
3/8"	.675	.495	.090
1/2"	.840	.626	.107
3/4"	1.050	.822	.114
1"	1.315	1.063	.126
1-1/4"	1.660	1.368	.146
1-1/2"	1.900	1.600	.150
2"	2.375	2.063	.156
2-1/2"	2.875	2.501	.187
3"	3.500	3.062	.219
3-1/2"	4.000	3.500	.250
4"	4.500	4.000	.250
4-1/2"	5.000	4.500	.250
5"	5.563	5.063	.250
6"	6.625	6.125	.250

STANDARD SIZE (INCHES)	ALLOWABLE PRESSURE POUNDS PER SQUARE INCH			
	@ 100° F	@ 200° F	@ 300° F	@ 400° F
1/8"	370	370	320	140
1/4"	870	870	760	330
3/8"	890	890	780	340
1/2"	900	900	790	340
3/4"	810	810	710	310
1"	630	630	560	240
1-1/4"	690	690	610	260
1-1/2"	630	630	560	240
2"	540	540	480	210
2-1/2"	450	450	390	170
3"	510	510	450	190
3-1/2"	570	570	500	220
4"	510	510	440	190
5"	410	410	360	160
6"	340	340	300	130

No-Lead 125LB seamless Threaded Red Brass Nipples - 2200



WARNING: This product can expose you to chemicals, including Nickel, which are known to the State of California to cause cancer. For more information, visit www.P65Warnings.ca.gov

BRASS SCH 40 SEAMLESS

FITTINGS AND NIPPLES

FITTINGS & NIPPLES

113RB



1/8" - 27



1/8" DIAMETER SCH 40 SEAMLESS

PART #	LENGTH	BOX/CASE	APPROX. WT. LBS.	LIST
40001	Close (3/4")	25/400	0.02	---
40002	x 1-1/2"	25/400	0.03	---
40003	x 2"	25/400	0.04	---
40004	x 2-1/2"	25/400	0.05	---
40005	x 3"	25/400	0.06	---
40006	x 3-1/2"	25/400	0.07	---
40007	x 4"	25/400	0.08	---
40008	x 4-1/2"	25/400	0.10	---
40009	x 5"	25/400	0.11	---
40010	x 5-1/2"	25/400	0.12	---
40011	x 6"	25/400	0.13	---
40012	x 7"	25/400	0.15	---
40013	x 8"	25/400	0.17	---
40014	x 9"	25/400	0.19	---
40015	x 10"	25/400	0.21	---
40017	x 12"	25/400	0.25	---



1/4"-18

1/4" DIAMETER SCH 40 SEAMLESS

PART #	LENGTH	BOX/CASE	APPROX. WT. LBS.	LIST
40020	Close (7/8")	25/400	0.03	---
40021	x 1-1/2"	25/400	0.05	---
40022	x 2"	25/400	0.07	---
40023	x 2-1/2"	25/400	0.09	---
40024	x 3"	25/400	0.11	---
40025	x 3-1/2"	25/400	0.13	---
40026	x 4"	25/400	0.14	---
40027	x 4-1/2"	25/400	0.16	---
40028	x 5"	25/400	0.18	---
40029	x 5-1/2"	25/400	0.20	---
40030	x 6"	25/400	0.22	---
40031	x 7"	25/200	0.25	---
40032	x 8"	25/200	0.29	---
40034	x 10"	25/200	0.36	---
40035	x 11"	25/200	0.40	---
40036	x 12"	25/200	0.43	---

WARNING: This product can expose you to chemicals, including Nickel, which are known to the State of California to cause cancer. For more information, visit www.P65Warnings.ca.gov



BRASS SCH 40 SEAMLESS

FITTINGS AND NIPPLES



**LEAD
FREE**

3/8"-18

3/8" DIAMETER SCH 40 SEAMLESS

PART #	LENGTH	BOX/CASE	APPROX. WT. LBS.	LIST
40040	Close (1")	25/400	0.05	---
40041	x 1-1/2"	25/400	0.08	---
40042	x 2"	25/400	0.10	---
40043	x 2-1/2"	25/400	0.13	---
40044	x 3"	25/400	0.16	---
40045	x 3-1/2"	25/400	0.18	---
40046	x 4"	25/400	0.21	---
40047	x 4-1/2"	25/300	0.23	---
40048	x 5"	25/300	0.26	---
40049	x 5-1/2"	25/300	0.29	---
40050	x 6"	25/300	0.31	---
40051	x 7"	25/200	0.36	---
40052	x 8"	25/150	0.42	---
40054	x 10"	25/100	0.52	---
40056	x 12"	25/100	0.62	---

113RB



**LEAD
FREE**

1/2" - 14

1/2" DIAMETER SCH 40 SEAMLESS

PART #	LENGTH	BOX/CASE	APPROX. WT. LBS.	LIST
40060	Close (1-1/8")	25/400	0.09	---
40061	x 1-1/2"	25/400	0.12	---
40062	x 2"	25/400	0.16	---
40063	x 2-1/2"	25/300	0.20	---
40064	x 3"	25/300	0.23	---
40065	x 3-1/2"	25/300	0.27	---
40066	x 4"	25/200	0.31	---
40067	x 4-1/2"	25/200	0.35	---
40068	x 5"	25/200	0.39	---
40069	x 5-1/2"	25/200	0.43	---
40070	x 6"	25/200	0.47	---
40071	x 7"	25/100	0.55	---
40072	x 8"	25/100	0.62	---
40073	x 9"	25/100	0.70	---
40074	x 10"	25/75	0.78	---
40075	x 11"	25/75	0.86	---
40076	x 12"	25/75	0.94	---
40079	x 24"			
40245	x 36"			

WARNING: This product can expose you to chemicals, including Nickel, which are known to the State of California to cause cancer. For more information, visit www.P65Warnings.ca.gov

FITTINGS & NIPPLES



BRASS SCH 40 SEAMLESS

FITTINGS AND NIPPLES

FITTINGS & NIPPLES



**LEAD
FREE**

3/4" - 14

3/4" DIAMETER SCH 40 SEAMLESS

PART #	LENGTH	BOX/CASE	APPROX. WT. LBS.	LIST
40080	Close (1- 3/8")	25/400	0.15	---
40081	x 1-1/2"	25/400	0.16	---
40082	x 2"	25/300	0.21	---
40083	x 2-1/2"	25/300	0.27	---
40084	x 3"	25/200	0.32	---
40085	x 3-1/2"	25/200	0.37	---
40086	x 4"	25/150	0.43	---
40087	x 4-1/2"	25/150	0.48	---
40088	x 5"	25/100	0.53	---
40089	x 5-1/2"	25/100	0.59	---
40090	x 6"	25/100	0.64	---
40091	x 7"	25/75	0.75	---
40092	x 8"	25/75	0.85	---
40093	x 9"	25/75	0.96	---
40094	x 10"	25/50	1.06	---
40095	x 11"	25/50	1.17	---
40096	x 12"	25/50	1.28	---
40097	x 18"	1/1	1.92	---
40098	x 24"	1/1	2.56	---
40099	x 36"	1/1	3.84	---

113RB



**LEAD
FREE**

1" - 11 1/2

1" DIAMETER SCH 40 SEAMLESS

PART #	LENGTH	BOX/CASE	APPROX. WT. LBS.	LIST
40100	Close (1-1/2")	25/200	0.23	---
40101	x 2"	25/200	0.30	---
40102	x 2-1/2"	25/150	0.38	---
40103	x 3"	25/150	0.45	---
40104	x 3-1/2"	25/100	0.53	---
40105	x 4"	25/100	0.60	---
40106	x 4-1/2"	25/100	0.68	---
40107	x 5"	25/75	0.75	---
40108	x 5-1/2"	25/75	0.83	---
40109	x 6"	25/50	0.94	---
40110	x 7"	25/50	1.05	---
40111	x 8"	25/50	1.20	---
40112	x 9"	25/50	1.35	---
40113	x 10"	25/50	1.50	---
40114	x 11"	25/50	1.65	---
40115	x 12"	20/40	1.80	---
40118	x 18"			
40119	x 24"			
40262	x 36"			

WARNING: This product can expose you to chemicals, including Nickel, which are known to the State of California to cause cancer. For more information, visit www.P65Warnings.ca.gov

BRASS SCH 40 SEAMLESS

FITTINGS AND NIPPLES



**LEAD
FREE**

1 1/4" - 11 1/2"

1-1/4" DIAMETER SCH 40 SEAMLESS

PART #	LENGTH	BOX/CASE	APPROX. WT. LBS.	LIST
40120	Close (1-5/8")	25/100	0.36	---
40121	x 2"	25/100	0.44	---
40122	x 2-1/2"	25/100	0.56	---
40123	x 3"	25/100	0.67	---
40124	x 3-1/2"	25/100	0.78	---
40125	x 4"	25/50	0.89	---
40126	x 4-1/2"	25/50	1.00	---
40127	x 5"	25/50	1.11	---
40128	x 5-1/2"	25/50	1.22	---
40129	x 6"	25/50	1.33	---
40131	x 8"	25/50	1.78	---
40135	x 12"	25/50	2.67	---

113RB



**LEAD
FREE**

1-1/2" - 11 1/2"

1-1/2" DIAMETER SCH 40 SEAMLESS

PART #	LENGTH	BOX/CASE	APPROX. WT. LBS.	LIST
40140	Close (1-3/4")	25/100	0.46	---
40141	x 2"	25/100	0.53	---
40142	x 2-1/2"	25/50	0.66	---
40143	x 3"	25/50	0.79	---
40144	x 3-1/2"	25/50	0.93	---
40145	x 4"	25/50	1.06	---
40146	x 4-1/2"	25/50	1.19	---
40147	x 5"	20/40	1.32	---
40148	x 5-1/2"	20/40	1.46	---
40149	x 6"	20/40	1.59	---
40151	x 8"	20/40	2.12	---
40153	x 10"	20/40	2.65	---
40155	x 12"	1/15	3.18	---

WARNING: This product can expose you to chemicals, including Nickel, which are known to the State of California to cause cancer. For more information, visit www.P65Warnings.ca.gov

FITTINGS & NIPPLES

BRASS SCH 40 SEAMLESS

FITTINGS AND NIPPLES

FITTINGS & NIPPLES



**LEAD
FREE**

2" - 11 1/2

2" DIAMETER SCH 40 SEAMLESS

PART #	LENGTH	BOX/CASE	APPROX. WT. LBS.	LIST
40160	Close (2")	25/50	0.69	---
40161	x 2-1/2"	25/50	0.86	---
40162	x 3"	25/50	1.03	---
40163	x 3-1/2"	25/50	1.20	---
40164	x 4"	1/25	1.37	---
40165	x 4-1/2"	1/25	1.54	---
40166	x 5"	1/25	1.72	---
40167	x 5-1/2"	1/25	1.89	---
40168	x 6"	1/25	2.06	---
40169	x 7"	1/20	2.40	---
40170	x 8"	1/18	2.74	---
40171	x 9"	1/18	3.09	---
40172	x 10"	1/18	3.43	---
40174	x 12"	1/14	4.12	---
40175	x 18"	1/1	6.18	---
40176	x 24"	1/1	8.24	---
40177	x 30"			
40178	x 36"	1/1	12.36	---
40179	x 48"	1/1	16.48	---

113RB



**LEAD
FREE**

2 1/2" - 8

2-1/2" DIAMETER SCH 40 SEAMLESS

PART #	LENGTH	BOX/CASE	APPROX. WT. LBS.	LIST
40180	Close (2-1/2")	1/36	1.26	---
40181	x 3"	1/36	1.51	---
40182	x 3-1/2"	1/30	1.76	---
40183	x 4"	1/30	2.02	---
40184	x 4-1/2"	1/30	2.27	---
40185	x 5"	1/20	2.52	---
40186	x 5-1/2"	1/20	2.77	---
40187	x 6"	1/20	3.03	---
40193	x 12"			

See our Valve section for 2-1/2, 3 and 4" Valves

WARNING: This product can expose you to chemicals, including Nickel, which are known to the State of California to cause cancer. For more information, visit www.P65Warnings.ca.gov

BRASS SCH 40 SEAMLESS

FITTINGS AND NIPPLES



LEAD
FREE

3" DIAMETER SCH 40 SEAMLESS

PART #	LENGTH	BOX/CASE	APPROX. WT. LBS.	LIST
40200	Close (2-5/8")	1/24	1.89	---
40201	x 3"	1/20	2.16	---
40203	x 4"	1/18	2.88	---
40205	x 5"	1/18	3.60	---
40206	x 5-1/2"	1/18	3.96	---
40207	x 6"	1/12	4.32	---
40209	x 8"	1/1	5.76	---
40211	x 10"			
40213	x 12"	1/1		---

113RB



LEAD
FREE

4" DIAMETER SCH 40 SEAMLESS

PART #	LENGTH	BOX/CASE	APPROX. WT. LBS.	LIST
40220	Close (2-7/8)	1/20	2.40	---
40234	x 6"	1/5	6.36	---

 **WARNING:** This product can expose you to chemicals, including Nickel, which are known to the State of California to cause cancer. For more information, visit www.P65Warnings.ca.gov

FITTINGS & NIPPLES

CHROME PLATED

FITTINGS AND NIPPLES

113CP



3/8" DIAMETER CHROME PLATED

PART #	LENGTH	BOX/CASE	APPROX. WT. LBS.	LIST
41040	X Close	5/25	0.05	---
41041	x 1-1/2"	5/25	0.08	---
41042	x 2"	5/25	0.10	---
41043	x 2-1/2"	5/25	0.13	---
41044	x 3"	5/25	0.16	---
41045	x 3-1/2"	5/25	0.18	---
41046	x 4"	5/25	0.21	---
41047	x 4-1/2"	5/25	0.23	---
41048	x 5"	5/25	0.26	---
41050	x 6"	5/25	0.31	---
41054	x 10"	1/1	0.52	---



1/2" DIAMETER CHROME PLATED

PART #	LENGTH	BOX/CASE	APPROX. WT. LBS.	LIST
41060	X Close	5/25	0.09	---
41061	x 1-1/2"	5/25	0.12	---
41062	x 2"	5/25	0.16	---
41063	x 2-1/2"	5/25	0.20	---
41064	x 3"	5/25	0.23	---
41065	x 3-1/2"	5/25	0.27	---
41066	x 4"	5/25	0.31	---
41067	x 4-1/2"	5/25	0.35	---
41068	x 5"	5/25	0.39	---
41069	x 5-1/2"	5/25	0.43	---
41070	x 6"	5/25	0.47	---
41072	x 8"			
41074	x 10"	1/1	0.78	---
41076	x 12"	1/1	0.94	---

WARNING: This product can expose you to chemicals, including Nickel, which are known to the State of California to cause cancer. For more information, visit www.P65Warnings.ca.gov

BRONZE FITTINGS

FITTINGS AND NIPPLES

BRONZE FITTINGS



UL842, UL258, UL125,FM



CLASS 125 (150) FOR STEAM, WATER, GAS, OIL AND AIR SERVICE STANDARD SPECIFICATIONS

Materials - ASTM B62-93 (85,5,5,5) C83600

Dimensions - ANSI B 16.15

Threads - ANSI B2.1 or BA 21 and Fed. WW-P-460C, MSS-SP-106, ANSI/ASME B1.20.1

- UL/ FM Approved
- ISO 9001:2000
- Not Lead Free
- RoHS Compliant

Bronze threaded fittings are manufactured from smooth-cored castings, designed to provide full flow with minimum restriction. All threads are accurately machined and gauged to ensure a perfect fit with the pipe. All fittings are individually tested under water to ensure quality. Bronze provides a tighter seal and is easier to install than other metals. Can be used for water, plumbing, heating, pneumatic and marine applications, able to resist the harmful effects of corrosion when coming into contact with salt water or fresh water polluted with mineral acids or peaty soils.

LEAD FREE BRASS FITTINGS

LEAD
FREE



- Approved to ANSI/NSF 61-4 California AB 1953
- Meets Federal State Drinking Water Act, Lead Free Requirement
- Brass fittings conform to AWWA C800
- Brass castings conform to ASTM B584, UNS Alloy C8933
- Brass fittings dimensions conform to ASME B16.15
- NPT threads on all fittings conform to ASME B1.20.1
- Brass unions conform to specification A-A-59617
- Manufacturing facilities are ISO 9001:2008

WARNING: This product can expose you to chemicals, including Nickel, which are known to the State of California to cause cancer. For more information, visit www.P65Warnings.ca.gov

FITTINGS & NIPPLES

BRONZE/ LEAD FREE BRONZE

FITTINGS AND NIPPLES

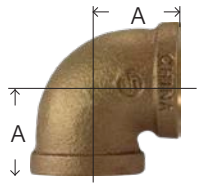

100RB

738100



90° ELBOWS

PART #	LIST	BOX/CASE	SIZE	PART #	LIST
44100	---	50/600	1/8"	44100LF	---
44101	---	35/420	1/4"	44101LF	---
44102	---	90/360	3/8"	44102LF	---
44103	---	50/200	1/2"	44103LF	---
44104	---	35/105	3/4"	44104LF	---
44105	---	20/60	1"	44105LF	---
44106	---	20/40	1-1/4"	44106LF	---
44107	---	15/30	1-1/2"	44107LF	---
44108	---	8/16	2"	44108LF	---
44109	---	1/12	2-1/2"	44109LF	---
44110	---	1/4	3"	44110LF	---

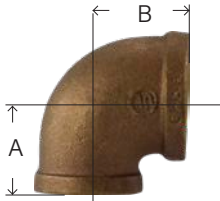

100RRB

738105



90° REDUCING ELBOWS

PART #	LIST	BOX/CASE	SIZE	PART #	LIST
44121	---		3/8 x 1/8	44121LF	---
	---		3/8 x 1/4	44122LF	---
	---	60/240	1/2 x 1/4	44123LF	---
44124	---	60/240	1/2 x 3/8	44124LF	---
	---	40/160	3/4 x 1/4	44125LF	---
44127	---		3/4 x 1/2	44127LF	---
	---		1 x 1/2	44130LF	---
44131	---	50/100	1 x 3/4	44131LF	---
44134	---	25/50	1 1/4 x 1	44134LF	---
	---		1 1/2 x 1 1/4	44138LF	---
	---		2 x 1 1/2	44142LF	---
	---		2 1/2 x 2	44146LF	---

WARNING: This product can expose you to chemicals, including Nickel, which are known to the State of California to cause cancer. For more information, visit www.P65Warnings.ca.gov

BRONZE/ LEAD FREE BRONZE

FITTINGS AND NIPPLES

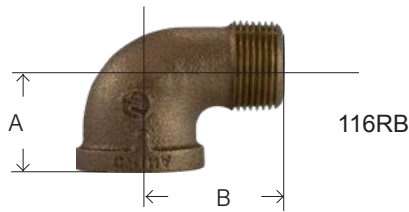

738116



90° STREET ELLS

PART #	LIST	BOX/CASE	SIZE	PART #	LIST
44160	---	60/720	1/8"	44160LF	---
44161	---	35/420	1/4"	44161LF	---
44162	---	60/240	3/8"	44162LF	---
44163	---	60/180	1/2"	44163LF	---
44164	---	35/105	3/4"	44164LF	---
44165	---	45/90	1"	44165LF	---
44166	---	25/50	1-1/4"	44166LF	---
44167	---	9/27	1-1/2"	44167LF	---
44168	---	8/16	2"	44168LF	---

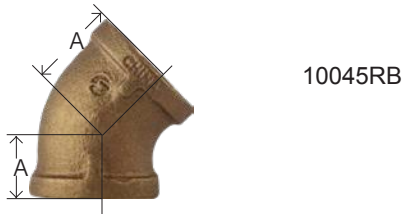

738107



45° ELBOWS

PART #	LIST	BOX/CASE	SIZE	PART #	LIST
44180	---	50/600	1/8"	44180LF	---
44181	---	30/360	1/4"	44181LF	---
44182	---	75/300	3/8"	44182LF	---
44183	---	50/200	1/2"	44183LF	---
44184	---	40/120	3/4"	44184LF	---
44185	---	20/60	1"	44185LF	---
44186	---	20/40	1-1/4"	44186LF	---
44187	---	10/30	1-1/2"	44187LF	---
44188	---	12/24	2"	44188LF	---
44189	---	1/12	2-1/2"		---

DROP EAR ELBOWS



• LEAD FREE BRONZE • LEAD FREE BRASS



• LEAD FREE BRASS



• LEAD FREE BRONZE

PART #	SWT X FIP	LIST PRICE
44840LF	1/2 x 1/2 Bronze	---
44841LF	1/2 x 1/2 Brass	---
44842LF	3/4 x 1/2 Brass	---
44843LF	1/2 x 3/4 Brass	---

PART #	SWT X SWT	LIST PRICE
44844LF	1/2 x 1/2	---

PART #	PEX X FIP	LIST PRICE
44845LF	1/2 x 1/2	---

WARNING: This product can expose you to chemicals, including Nickel, which are known to the State of California to cause cancer. For more information, visit www.P65Warnings.ca.gov

FITTINGS & NIPPLES

BRONZE/ LEAD FREE BRONZE

FITTINGS AND NIPPLES

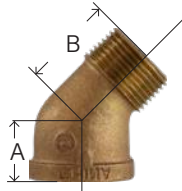

124RB

738124



45° STREET ELBOWS

PART #	LIST	BOX/CASE	SIZE	PART #	LIST
44200	---	70/840	1/8"	44200LF	---
44201	---	100/400	1/4"	44201LF	---
44202	---	100/400	3/8"	44202LF	---
44203	---	75/225	1/2"	44203LF	---
44204	---	40/120	3/4"	44204LF	---
44205	---	25/75	1"	44205LF	---
44206	---	10/40	1-1/4"	44206LF	---
44207	---	10/30	1-1/2"	44207LF	---
44208	---	12/24	2"	44208LF	---



102RB

738102



CROSSES

PART #	LIST	BOX/CASE	SIZE	PART #	LIST
44391	---	60/240	1/4"	44391LF	---
44392	---	50/150	3/8"	44392LF	---
44393	---	30/90	1/2"	44393LF	---
44394	---	20/60	3/4"	44394LF	---
44395	---	15/30	1"	44395LF	---
44396	---	10/20	1-1/4"	44396LF	---
44397	---	8/16	1-1/2"	44397LF	---
44398	---	5/10	2"	44398LF	---
38102-32					

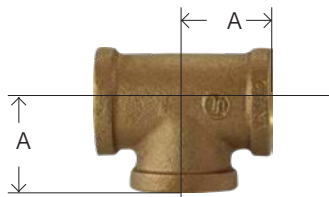

101RB



TEES

PART #	LIST	BOX/CASE	SIZE	PART #	LIST
44250	---	120/480	1/8"	44250LF	---
44251	---	75/300	1/4"	44251LF	---
44252	---	45/180	3/8"	44252LF	---
44253	---	40/120	1/2"	44253LF	---
44254	---	35/70	3/4"	44254LF	---
44255	---	20/40	1"	44255LF	---
44256	---	14/28	1-1/4"	44256LF	---
44257	---	12/24	1-1/2"	44257LF	---
44258	---	8/16	2"	44258LF	---
44259	---	1/6	2-1/2"	44259LF	---
44260	---	1/6	3"	44260LF	---
			4"	44261LF	---

WARNING: This product can expose you to chemicals, including Nickel, which are known to the State of California to cause cancer. For more information, visit www.P65Warnings.ca.gov

BRONZE/ LEAD FREE BRONZE

FITTINGS AND NIPPLES

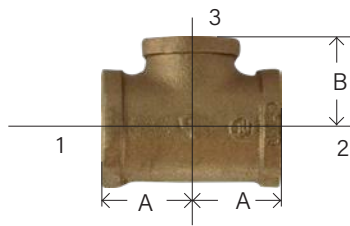

101RRB

738106



REDUCING TEES REDUCING ON THE BRANCH

PART #	LIST	BOX/CASE	SIZE 1 X 2 X 3	PART #	LIST
			1/4 x 1/4 x 1/8	44270LF	---
44276	---	40/160	1/2 x 1/2 x 1/4	44276LF	---
			1/2 x 1/2 x 3/8	44279LF	---
	---	40/160	1/2 x 1/2 x 3/4	44280LF	---
44287	---		3/4 x 1/2 x 1/2	44287LF	---
44288			3/4 x 1/2 x 3/4	44288LF	---
44282	---	25/100	3/4 x 3/4 x 1/4	44282LF	---
	---	25/100	3/4 x 3/4 x 3/8	44283LF	---
44286	---	20/80	3/4 x 3/4 x 1/2	44286LF	---
			1 x 1/2 x 1/2	44292LF	---
			1 x 1/2 x 3/4	44293LF	---
44296	---		1 x 3/4 x 3/4	44296LF	---
			1 x 1 x 1/4	44268LF	---
			1 x 1 x 3/8	44290LF	---
	---	15/60	1 x 1 x 1/2	44291LF	---
44298	---	12/48	1 x 1 x 3/4	44298LF	---
			1 1/4 x 1/2 x 1 1/4	44314LF	---
	---	20/40	1 1/4 x 1 1/4 x 1/2	44301LF	---
44303	---	20/40	1 1/4 x 1 1/4 x 3/4	44303LF	---
	---	20/40	1 1/4 x 1 1/4 x 1	44306LF	---
			1 1/2 x 1 1/2 x 1/2	44315LF	---
			1 1/2 x 1 1/2 x 3/4	44316LF	---
			1 1/2 x 1 1/2 x 1	44318LF	---
			1 1/2 x 1 1/2 x 1 1/4	44322LF	---
			2 x 2 x 1/2	44327LF	---
			2 x 2 x 3/4	44328LF	---
			2 x 2 x 1	44330LF	---
			2 x 2 x 1 1/2	44336LF	---
			3 x 3 x 2	44351LF	---

WARNING: This product can expose you to chemicals, including Nickel, which are known to the State of California to cause cancer. For more information, visit www.P65Warnings.ca.gov

FITTINGS & NIPPLES

BRONZE/ LEAD FREE BRONZE

FITTINGS AND NIPPLES

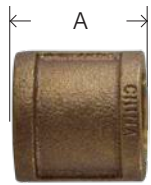

103RB

738103

COUPLINGS



PART #	LIST	BOX/CASE	SIZE	PART #	LIST
44410	---	70/840	1/8"	44410LF	---
44411	---	40/480	1/4"	44411LF	---
44412	---	40/480	3/8"	44412LF	---
44413	---	60/240	1/2"	44413LF	---
44414	---	50/150	3/4"	44414LF	---
44415	---	25/100	1"	44415LF	---
44416	---	16/64	1-1/4"	44416LF	---
44417	---	18/36	1-1/2"	44417LF	---
44418	---	12/24	2"	44418LF	---
44419	---	1	2-1/2"	44419LF	---
44420	---	1	3"	44420LF	---
			4"	44421LF	---



119RB

738119

REDUCING COUPLINGS



PART #	LIST	BOX/CASE	SIZE	PART #	LIST
44430	---	70/840	1/4" x 1/8"	44430LF	---
44431	---	35/420	3/8" x 1/8"	44431LF	---
44432	---	30/360	3/8" x 1/4"	44432LF	---
44433	---	75/300	1/2" x 1/8"	44433LF	---
44434	---	75/300	1/2" x 1/4"	44434LF	---
44435	---	60/240	1/2" x 3/8"	44435LF	---
44436	---	45/180	3/4" x 1/4"	44436LF	---
44437	---	45/180	3/4" x 3/8"	44437LF	---
44438	---	60/180	3/4" x 1/2"	44438LF	---
44440	---	30/120	1" x 3/8"	44440LF	---
44441	---	30/120	1" x 1/2"	44441LF	---
44442	---	25/100	1" x 3/4"	44442LF	---
44445	---	25/75	1-1/4" x 3/4"	44445LF	---
44446	---	15/60	1-1/4" x 1"	44446LF	---
44447	---	20/60	1-1/2" x 1/2"	44447LF	---
44448	---	15/60	1-1/2" x 3/4"	44448LF	---
44449	---	25/50	1-1/2" x 1"	44449LF	---
44450	---	12/48	1-1/2" x 1-1/4"	44450LF	---
44451	---	12/36	2" x 3/4"	44451LF	---
44452	---	12/36	2" x 1"	44452LF	---
44453	---	9/27	2" x 1-1/4"	44453LF	---
44454	---	9/27	2" x 1-1/2"	44454LF	---
44462	---	1	2-1/2" x 2"	44462LF	---
44456	---	1	3" x 2"	44456LF	---
		1	3" x 2-1/2"	44463LF	---

WARNING: This product can expose you to chemicals, including Nickel, which are known to the State of California to cause cancer. For more information, visit www.P65Warnings.ca.gov

BRONZE/ LEAD FREE BRONZE

FITTINGS AND NIPPLES



108RB

738108



CAPS

PART #	LIST	BOX/CASE	SIZE	PART #	LIST
44470	---	80/160	1/8"	44470LF	---
44471	---	80/960	1/4"	44471LF	---
44472	---	60/720	3/8"	44472LF	---
44473	---	75/300	1/2"	44473LF	---
44474	---	40/160	3/4"	44474LF	---
44475	---	25/100	1"	44475LF	---
44476	---	20/80	1-1/4"	44476LF	---
44477	---	18/54	1-1/2"	44477LF	---
44478	---	12/36	2"	44478LF	---
	---		2-1/2"	44479LF	---
44480	---	1	3"	44480LF	---



104RB

738104



UNIONS

PART #	LIST	BOX/CASE	SIZE	PART #	LIST
44600	---	40/160	1/8"	44600LF	---
44601	---	40/160	1/4"	44601LF	---
44602	---	40/160	3/8"	44602LF	---
44603	---	50/100	1/2"	44603LF	---
44604	---	35/70	3/4"	44604LF	---
44605	---	20/40	1"	44605LF	---
44606	---	15/30	1-1/4"	44606LF	---
44607	---	10/20	1-1/2"	44607LF	---
44608	---	6/12	2"	44608LF	---
44609	---	4/8	2-1/2"	44609LF	---
44610	---	4/8	3"	44610LF	---

WARNING: This product can expose you to chemicals, including Nickel, which are known to the State of California to cause cancer. For more information, visit www.P65Warnings.ca.gov

FITTINGS & NIPPLES

BRONZE/ LEAD FREE BRONZE

FITTINGS AND NIPPLES



Hex
110RB

738110



HEX BUSHINGS

PART #	LIST	BOX/CASE	SIZE	PART #	LIST
44500	---	120/1440	1/4" x 1/8"	44500LF	---
44501	---	75/900	3/8" x 1/8"	44501LF	---
44502	---	75/900	3/8" x 1/4"	44502LF	---
44503	---	150/600	1/2" x 1/8"	44503LF	---
44504	---	150/600	1/2" x 1/4"	44504LF	---
44505	---	150/600	1/2" x 3/8"	44505LF	---
44506	---	75/300	3/4" x 1/8"	44506LF	---
44507	---	75/300	3/4" x 1/4"	44507LF	---
44508	---	75/300	3/4" x 3/8"	44508LF	---
44509	---	75/300	3/4" x 1/2"	44509LF	---
44510*	---	50/200	1" x 1/4"	44510LF*	---
44511*	---	50/200	1" x 3/8"	44511LF	---
44512	---	50/200	1" x 1/2"	44512LF	---
44513	---	50/200	1" x 3/4"	44513LF	---
44515	---	30/120	1-1/4" x 3/8"		---
44516*	---	30/120	1-1/4" x 1/2"		---
44517	---	30/120	1-1/4" x 3/4"	44517LF	---
44518	---	30/120	1-1/4" x 1"	44518LF	---
44521*	---	25/75	1-1/2" x 1/2"	44521LF*	---
44522*	---	25/75	1-1/2" x 3/4"	44522LF*	---
44523	---	25/75	1-1/2" x 1"	44523LF	---
44524	---	25/75	1-1/2" x 1-1/4"	44524LF	---
44527*	---	20/60	2" x 1/2"	44527LF	---
44528*	---	20/60	2" x 3/4"	44528LF	---
44529*	---	20/60	2" x 1"	44529LF*	---
44530	---	20/60	2" x 1-1/4"	44530LF	---
44531	---	20/60	2" x 1-1/2"	44531LF	---
44535	---	15/30	2-1/2" x 2"	44535LF	---
44538	---	12/24	3" x 2"	44538LF	---
44539	---	12/24	3" x 2-1/2"	44539LF	---
44543	---	12/24	4" x 3"	44543LF	---

* INSIDE HEX



WARNING: This product can expose you to chemicals, including Nickel, which are known to the State of California to cause cancer.
 For more information, visit www.P65Warnings.ca.gov

BRONZE/ LEAD FREE BRONZE

FITTINGS AND NIPPLES

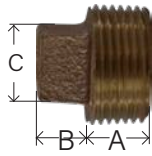

109RB

738109



CORED SQUARE HEAD PLUGS

PART #	LIST	BOX/CASE	SIZE	PART #	LIST
44650*	---	300/3600	1/8"	44650LF	---
44651*	---	150/1800	1/4"	44651LF	---
44652*	---	100/1200	3/8"	44652LF	---
44653	---	50/600	1/2"	44653LF	---
44654	---	30/360	3/4"	44654LF	---
44655	---	20/240	1"	44655LF	---
44656	---	40/120	1-1/4"	44656LF	---
44657	---	30/90	1-1/2"	44657LF	---
44658	---	20/60	2"	44658LF	---
44660	---	16/32	3"		---

* solid

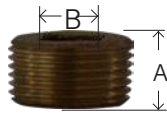

109ALRB

SQUARE DRIVE

738115

BRONZE COUNTERSUNK PLUGS



PART #	LIST	SIZE	BOX/CASE	PART #	LIST
44633	---	1/2"	120/1440		
44634	---	3/4"	70/840	44634LF	---
44635	---	1"	20/240		---
44636	---	1-1/4"	40/120		---
44637	---	1-1/2"	30/90		---
44638	---	2"	20/60		---



• Straight Thread

111RB

HEX LOCKNUTS

PART #	LIST	BOX/CASE	SIZE
44701	---	90/540	1/4"
44703	---	90/360	1/2"
44704	---	90/360	3/4"
44705	---	50/150	1"

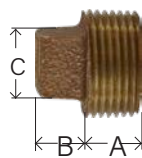

109SRB

738114

SOLID SQUARE HEAD PLUGS



PART #	LIST	SIZE	BOX/CASE	PART #	LIST
44670	---	1/8"	400/4800	44670LF	---
44671	---	1/4"	150/1800	44671LF	---
44672	---	3/8"	120/1440	44672LF	---
44673	---	1/2"	50/600	44673LF	---
44674	---	3/4"	35/420	44674LF	---
44675	---	1"	20/240	44675LF	---
44676	---	1-1/4"	30/120	44676LF	---
44677	---	1-1/2"	30/90	44677LF	---
44678	---	2"	10/60	44678LF	---
		4"			---

WARNING: This product can expose you to chemicals, including Nickel, which are known to the State of California to cause cancer. For more information, visit www.P65Warnings.ca.gov

BRONZE/ LEAD FREE BRONZE

FITTINGS AND NIPPLES

HEX NIPPLES

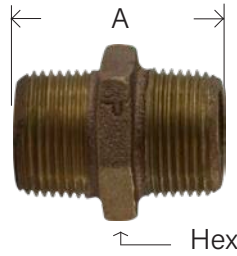

PART #	LIST	SIZE	BOX/CASE
44720	---	1/8"	400/4800
44721	---	1/4"	150/1800
44722	---	3/8"	120/1440
44723	---	1/2"	240/480
44724	---	3/4"	80/320
44725	---	1"	50/150
44726	---	1-1/4"	50/100
44727	---	1-1/2"	35/70
44728	---	2"	20/40

REDUCING HEX NIPPLES

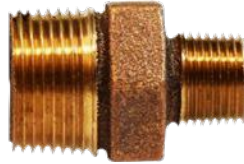

PART #	LIST	SIZE	BOX/CASE
44740	---	1/4" x 1/8"	1/1
44742	---	1/2" x 3/8"	1/1
44753	---	1-1/2" x 1-1/4"	1/1

FLANGE THREADED COMPANION LEAD-FREE



PART #	LIST	THREAD X OD	STD. PACK.	WT. PER 100
44791LF	---	3/4" x 3-7/8"	1	124
44792LF	---	1" x 4-1/4"	1	168
44794LF	---	1-1/2" x 5"	1	251
44795LF	---	2" x 6"	1	454
44796LF	---	2-1/2" x 7"	1	673
44797LF	---	3" x 7-1/2"	1	864
44798LF	---	4" x 9"	1	1227

WARNING: This product can expose you to chemicals, including Nickel, which are known to the State of California to cause cancer. For more information, visit www.P65Warnings.ca.gov

CHROME PLATED BRONZE FITTINGS

FITTINGS AND NIPPLES

90° ELBOW



781100



PART #	SIZE	LIST
45102LF	3/8"	---
45103LF	1/2"	---
45104LF	3/4"	---
45105LF	1"	---

COUPLING



781103



PART #	SIZE	LIST
45412LF	3/8"	---
45413LF	1/2"	---

90° ELBOW



81100

PART #	SIZE	LIST
45102	3/8"	---
45103	1/2"	---
45104	3/4"	---
45105	1"	---

90° STREET ELLS



81116

PART #	SIZE	LIST
45162	3/8"	---
45163	1/2"	---
45164	3/4"	---
45165	1"	---

COUPLINGS

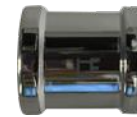

81103

PART #	SIZE	LIST
45412	3/8"	---
45413	1/2"	---
45414	3/4"	---
45435	1/2" x 3/8"	---

CAPS



81108

PART #	SIZE	LIST
45473	1/2"	---

PLUGS



PART #	SIZE	LIST
45652	3/8"	---
45653	1/2"	---

WARNING: This product can expose you to chemicals, including Nickel, which are known to the State of California to cause cancer. For more information, visit www.P65Warnings.ca.gov

FITTINGS & NIPPLES

SCH 40 STAINLESS STEEL NIPPLES

FITTINGS AND NIPPLES

STAINLESS STEEL NIPPLES



SCHEDULE 40 WELDED

Stainless steel pipe nipples are manufactured from stainless steel pipe that conforms to specification ASTM A312/ SA312.

All stainless steel nipples conform to specification ASTM A733. Threads conform to the requirements of ANSI B1.20.1.

304

The basic alloy. Type 304 (18-8) is an austenitic steel possessing a minimum of 18% chromium and 8% nickel, combined with a maximum of 0.08% carbon. It is a nonmagnetic steel which cannot be hardened by heat treatment, but instead, must be cold worked to obtain higher tensile strengths.

Because of its ability to withstand the corrosive action of various acids found in fruits, meats, milk, and vegetables,

Type 304 is especially suited for all types of dairy equipment piping and valves, the brewing industry, the citrus and fruit juice industry, and in food processing applications. Also used for the dye tanks, pipelines buckets, dippers, etc. that come in contact with the lormic, acetic, and other organic acids used in the dyeing industry.

In the marine environment, because of its slightly higher strength and wear resistance than type 316 it is also used for nuts, bolts, screws, and other fasteners. It is also used for springs, cogs, and other components where both wear and corrosion resistance is needed.



SCHEDULE 80 SEAMLESS

- See www.midlandindustries.com
- Seamless For Unrestricted Flow
- Use With Air, Water, Oil, Natural Gas, Steam
- Fittings: Use Threaded Class 3000 High-Pressure Stainless Steel.
- ASTM A733
- ASTM A312
- ANSI/ ASME B1.20.1
- PSI 3000

316

For severe environments. Of course, there are many industrial processes that require a higher level of resistance to corrosion than Type 304 can offer. For these applications, Type 316 is the answer.

In type 316, the nickel content is increased slightly. What distinguishes Type 316 from Type 304 is the addition of molybdenum up to a maximum of 3%.

Molybdenum increases the corrosion resistance of this chromium-nickel alloy to withstand attack by many industrial chemicals and solvents, and, in particular, inhibits pitting caused by chlorides. As such, molybdenum is one of the single most useful alloying additives in the fight against corrosion.

Type 316 can withstand corrosive attack by sodium and calcium brines, hypochlorite solutions, phosphoric acid; and the sulfite liquors and sulfurous acids used in the paper pulp industry. This alloy, therefore, is specified for industrial equipment that handles the corrosive process chemicals used to produce inks, rayons, photographic chemicals, paper, textiles, bleaches, and rubber. Type 316 is also used extensively for surgical implants within the hostile environment of the body.

Type 316 is the main stainless used in the marine environment, with the exception of fasteners and other items where strength and wear resistance are needed, then Type 304 (18-8) is typically used.

WARNING: This product can expose you to chemicals, including Nickel, which are known to the State of California to cause cancer. For more information, visit www.P65Warnings.ca.gov



SCH 40 STAINLESS STEEL NIPPLES

FITTINGS AND NIPPLES

#304

1/8" - 27

#316



1/8" DIAMETER
SCH 40 WELDED



PART # 304 S.S.	LIST PRICE	LENGTH	BOX	APPROX. WT. LBS.	PART # 316 S.S.	LIST PRICE
48001	---	X Close (3/4")	25	0.01	49001	---
48002	---	x 1-1/2"	25	0.03	49002	---
48003	---	x 2"	25	0.04	49003	---
48004	---	x 2-1/2"	25	0.05	49004	---
48005	---	x 3"	25	0.06	49005	---
48006	---	x 3-1/2"	25	0.07	49006	---
48007	---	x 4"	25	0.07	49007	---
48008	---	x 4-1/2"	25	0.09	49008	---
48009	---	x 5"	25	0.10	49009	---
48010	---	x 5-1/2"	25	0.11	49010	---
48011	---	x 6"	25	0.12	49011	---
48015	---	x 10"	1	0.19		
		x 12"	1	0.24	49017	---

1/4" - 18



1/4" DIAMETER
SCH 40 WELDED



PART # 304 S.S.	LIST PRICE	LENGTH	BOX	APPROX. WT. LBS.	PART # 316 S.S.	LIST PRICE
48020	---	X Close (7/8")	25	0.02	49020	---
48021	---	x 1-1/2"	25	0.04	49021	---
48022	---	x 2"	25	0.06	49022	---
48023	---	x 2-1/2"	25	0.07	49023	---
48024	---	x 3"	25	0.09	49024	---
48025	---	x 3-1/2"	25	0.11	49025	---
48026	---	x 4"	25	0.13	49026	---
48027	---	x 4-1/2"	25	0.14	49027	---
48028	---	x 5"	25	0.16	49028	---
48029	---	x 5-1/2"	25	0.18	49029	---
48030	---	x 6"	25	0.19	49030	---
48032	---	x 8"	1	0.25	49032	---
		x 9"	1	0.31	49033	---
48034	---	x 10"	1	0.35	49034	---
		x 11"	1	0.40	49035	---
48036	---	x 12"	1	0.44	49036	---

WARNING: This product can expose you to chemicals, including Nickel, which are known to the State of California to cause cancer. For more information, visit www.P65Warnings.ca.gov

FITTINGS & NIPPLES

SCH 40 STAINLESS STEEL NIPPLES

FITTINGS AND NIPPLES

#304

3/8"-18

#316



3/8" DIAMETER
SCH 40 WELDED



PART # 304 S.S.	LIST PRICE	LENGTH	BOX	APPROX. WT. LBS.	PART # 316 S.S.	LIST PRICE
48040	---	X Close (1")	25	0.03	49040	---
48041	---	x 1-1/2"	25	0.06	49041	---
48042	---	x 2"	25	0.07	49042	---
48043	---	x 2-1/2"	25	0.10	49043	---
48044	---	x 3"	25	0.12	49044	---
48045	---	x 3-1/2"	25	0.15	49045	---
48046	---	x 4"	25	0.17	49046	---
48047	---	x 4-1/2"	25	0.19	49047	---
48048	---	x 5"	25	0.22	49048	---
48049	---	x 5-1/2"	25	0.23	49049	---
48050	---	x 6"	25	0.26	49050	---



1/2" - 14

1/2" DIAMETER
SCH 40 WELDED



PART # 304 S.S.	LIST PRICE	LENGTH	BOX	APPROX. WT. LBS.	PART # 316 S.S.	LIST PRICE
48060	---	X Close 1-1/8"	25	0.05	49060	---
48061	---	x 1-1/2"	25	0.07	49061	---
48062	---	x 2"	25	0.10	49062	---
48063	---	x 2-1/2"	25	0.14	49063	---
48064	---	x 3"	25	0.18	49064	---
48065	---	x 3-1/2"	25	0.20	49065	---
48066	---	x 4"	25	0.25	49066	---
48067	---	x 4-1/2"	25	0.28	49067	---
48068	---	x 5"	25	0.31	49068	---
48069	---	x 5-1/2"	25	0.34	49069	---
48070	---	x 6"	25	0.39	49070	---
48071	---	x 7"	1	0.41		
48072	---	x 8"	1	0.52		---
48073	---	x 9"	1	0.54		
48074	---	10"	1	0.58		---
48075	---	x 11"	1	0.64		
48076	---	x 12"	1	0.69	49076	

WARNING: This product can expose you to chemicals, including Nickel, which are known to the State of California to cause cancer. For more information, visit www.P65Warnings.ca.gov

FITTINGS & NIPPLES

SCH 40 STAINLESS STEEL NIPPLES

FITTINGS AND NIPPLES

#304



3/4" - 14

#316



3/4" DIAMETER
SCH 40 WELDED

PART # 304 S.S.	LIST PRICE	LENGTH	BOX	APPROX. WT. LBS.	PART # 316 S.S.	LIST PRICE
48080	---	X Close (1-3/8")	25	0.08	49080	---
48081	---	x 1-1/2"	25	0.13	49081	---
48082	---	x 2"	25	0.14	49082	---
48083	---	x 2-1/2"	25	0.17	49083	---
48084	---	x 3"	25	0.22	49084	---
48085	---	x 3-1/2"	25	0.27	49085	---
48086	---	x 4"	25	0.32	49086	---
48087	---	x 4-1/2"	25	0.38	49087	---
48088	---	x 5"	25	0.40	49088	---
48089	---	x 5-1/2"	25	0.42	49089	---
48090	---	x 6"	25	0.48	49090	---
	---	x 7"	1	0.45	49091	
48092	---	x 8"	1	0.67	49092	---
48094	---	x 10"	1	0.94	49094	---
48096	---	x 12"	1	1.03	49096	



1" - 11 1/2



1" DIAMETER
SCH 40 WELDED

PART # 304 S.S.	LIST PRICE	LENGTH	BOX	APPROX. WT. LBS.	PART # 316 S.S.	LIST PRICE
48100	---	X Close (1-1/2")	25	0.13	49100	---
48101	---	x 2"	25	0.20	49101	---
48102	---	x 2-1/2"	25	0.25	49102	---
48103	---	x 3"	25	0.33	49103	---
48104	---	x 3-1/2"	25	0.40	49104	---
48105	---	x 4"	25	0.47	49105	---
48106	---	x 4-1/2"	25	0.53	49106	---
48107	---	x 5"	25	0.55	49107	---
48108	---	x 5-1/2"	25	0.60	49108	---
48109	---	x 6"	25	0.71	49109	---
48110	---	x 7"	1	0.57		---
48111	---	x 8"	1	1.02	49111	---
48113	---	x 10"	1	1.16	49113	---
48115	---	x 12"	1	1.31	49115	

WARNING: This product can expose you to chemicals, including Nickel, which are known to the State of California to cause cancer. For more information, visit www.P65Warnings.ca.gov

FITTINGS & NIPPLES

SCH 40 STAINLESS STEEL NIPPLES

FITTINGS AND NIPPLES



1 1/4" - 11 1/2"



1-1/4" DIAMETER
SCH 40 WELDED

PART # 304 S.S.	LIST PRICE	LENGTH	BOX	APPROX. WT. LBS.	PART # 316 S.S.	LIST PRICE
48120	---	X Close (1-5/8")	10	0.17	49120	---
48121	---	x 2"	10	0.23	49121	---
48122	---	x 2-1/2"	10	0.35	49122	---
48123	---	x 3"	10	0.46	49123	---
48124	---	x 3-1/2"	10	0.52	49124	---
48125	---	x 4"	10	0.65	49125	---
48126	---	x 4-1/2"	10	0.53	49126	---
48127	---	x 5"	10	0.60	49127	---
48128	---	x 5-1/2"	10	0.61	49128	---
48129	---	x 6"	10	0.71	49129	---
48131	---	x 8"	1	1.34		
48135	---	x 12"	1	1.54		



1-1/2" - 11 1/2"



1-1/2" DIAMETER
SCH 40 WELDED

PART # 304 S.S.	LIST PRICE	LENGTH	BOX	APPROX. WT. LBS.	PART # 316 S.S.	LIST PRICE
48140	---	X Close x 1-3/4"	10	0.25	49140	---
48141	---	x 2"	10	0.32	49141	---
48142	---	x 2-1/2"	10	0.41	49142	---
48143	---	x 3"	10	0.52	49143	---
48144	---	x 3-1/2"	10	0.62	49144	---
48145	---	x 4"	10	0.73	49145	---
48146	---	x 4-1/2"	10	0.86	49146	---
48147	---	x 5"	10	0.95	49147	---
48148	---	x 5-1/2"	10	1.01	49148	---
48149	---	x 6"	10	1.19	49149	---
48151	---	x 8"	1	1.63		---
48152	---	x 9"	1	1.88		---
48153	---	x 10"	1	2.28		---
48155	---	x 12"	1	2.43		---

WARNING: This product can expose you to chemicals, including Nickel, which are known to the State of California to cause cancer.
 For more information, visit www.P65Warnings.ca.gov

SCH 40 STAINLESS STEEL NIPPLES

FITTINGS AND NIPPLES



2" DIAMETER
SCH 40 WELDED



PART # 304 S.S.	LIST PRICE	LENGTH	BOX	APPROX. WT. LBS.	PART # 316 S.S.	LIST PRICE
48160	---	X Close (2")	10	0.37	49160	---
48161	---	x 2-1/2"	10	0.54	49161	---
48162	---	x 3"	10	0.65	49162	---
48163	---	x 3-1/2"	10	0.88	49163	---
48164	---	x 4"	10	1.02	49164	---
48165	---	x 4-1/2"	10	1.16	49165	---
48166	---	x 5"	10	1.29	49166	---
48167	---	x 5-1/2"	10	1.46	49167	---
48168	---	x 6"	10	1.57	49168	---
48170	---	x 8"	1	2.01	49170	---
48172	---	x 10"	1	2.69		
48174	---	x 12"	1	2.89	49174	

2-1/2" DIAMETER
SCH 40 WELDED

PART # 304 S.S.	LENGTH	BOX	APPROX. WT. LBS.	LIST PRICE
48180	X Close (2-1/2")	10	0.64	---
48187	x 6"	1	2.37	---



3" DIAMETER
SCH 40 WELDED

PART # 304 S.S.	LIST PRICE	LENGTH	BOX	APPROX. WT. LBS.	PART # 316 S.S.	LIST PRICE
48200	---	X Close (2-5/8")	10	0.95	49200	---
48201	---	x 3"	10	1.32	49201	---
48203	---	x 4"	10	1.66	49203	---
48205	---	x 5"	5	1.72		---
48207	---	x 6"	5	1.88	49207	---
48213	---	x 12"	1	2.12	49213	---



4" DIAMETER
SCH 40 WELDED

PART # 304 S.S.	LIST PRICE	LENGTH	BOX	APPROX. WT. LBS.	PART # 316 S.S.	LIST PRICE
48220	---	X Close (2-7/8")	8	1.15	49220	---
48223		x 4"	1	2.98	49223	---
48227	---	x 6"	1	4.10	49234	---
48229		x 8"	1	5.95	49236	---

WARNING: This product can expose you to chemicals, including Nickel, which are known to the State of California to cause cancer. For more information, visit www.P65Warnings.ca.gov

FITTINGS & NIPPLES

304 AND 316 150# SS FITTINGS

FITTINGS AND NIPPLES

STAINLESS STEEL FITTINGS



150# 304 & 316 Stainless Steel Fittings

Our high quality standard pattern 150lb rated stainless steel threaded fittings are manufactured to the highest standards. All stainless steel fittings are monitored by our quality control personnel for strict compliance with applicable standards and specifications.

These stainless steel pipe fittings are excellent for uses that involve chemicals or liquids that may be corrosive. Along with fighting corrosion, a stainless steel pipe fitting will prevent contamination making it useful to many professionals.

- Use with air, water, oil, natural gas, steam
- NPT and FNPT threads conform to ASME B1.20.1
- Maximum Pressure: 300 psi @ 72 F; 150 psi @ 366 F for steam
- Maximum Steam Pressure: 150 psi
- Material Conforms to ASTM A-351. Class 150 Pressure Ratings
- Manufacturing facility is ISO 9001:2008
- 304 Stainless Steel is economically priced, chromium-nickel material that offers very good corrosion resistance. 316 Stainless Steel has higher nickel content and contains molybdenum for even better corrosion resistance.

WARNING: This product can expose you to chemicals, including Nickel, which are known to the State of California to cause cancer. For more information, visit www.P65Warnings.ca.gov

304 AND 316 150# SS FITTINGS

FITTINGS AND NIPPLES

90° ELBOW 304 & 316 150#



PART # 304 S.S.	LIST PRICE	SIZE	BOX	APPROX. WT. LBS.	PART # 316 S.S.	LIST PRICE
62100	---	1/8"	25	0.06	63100	---
62101	---	1/4"	25	0.06	63101	---
62102	---	3/8"	25	0.11	63102	---
62103	---	1/2"	25	0.13	63103	---
62104	---	3/4"	25	0.20	63104	---
62105	---	1"	10	0.33	63105	---
62106	---	1-1/4"	10	0.55	63106	---
62107	---	1-1/2"	5	0.77	63107	---
62108	---	2"	5	1.10	63108	---
62109	---	2-1/2"	1	2.09		
62110	---	3"	1	2.84	63110	---
62112	---	4"	1	5.00	63112	---

90° STREET ELBOW 304 & 316 150#



PART # 304 S.S.	LIST PRICE	SIZE	BOX	APPROX. WT. LBS.	PART # 316 S.S.	LIST PRICE
62160	---	1/8"	25	0.04	63160	---
62161	---	1/4"	25	0.07	63161	---
62162	---	3/8"	25	0.09	63162	---
62163	---	1/2"	25	0.15	63163	---
62164	---	3/4"	25	0.24	63164	---
62165	---	1"	10	0.31	63165	---
62166	---	1-1/4"	10	0.51	63166	---
62167	---	1-1/2"	5	0.84	63167	---
62168	---	2"	5	1.26	63168	---
62169	---	3"	1	4.16	63170	---

45° ELBOW 304 & 316 150#



PART # 304 S.S.	LIST PRICE	SIZE	BOX	APPROX. WT. LBS.	PART # 316 S.S.	LIST PRICE
62180	---	1/8"	25	0.04	63180	---
62181	---	1/4"	25	0.07	63181	---
62182	---	3/8"	25	0.09	63182	---
62183	---	1/2"	25	0.13	63183	---
62184	---	3/4"	25	0.20	63184	---
62185	---	1"	10	0.33	63185	---
62186	---	1-1/4"	10	0.49	63186	---
62187	---	1-1/2"	5	0.66	63187	---
62188	---	2"	5	1.14	63188	---
62189	---	2-1/2"	1	2.82		
62190	---	3"	1	2.91	63190	---
62191	---	4"	1	5.05	63192	---

WARNING: This product can expose you to chemicals, including Nickel, which are known to the State of California to cause cancer. For more information, visit www.P65Warnings.ca.gov

FITTINGS & NIPPLES

304 AND 316 150# SS FITTINGS

FITTINGS AND NIPPLES

TEE 304 & 316 150#



PART # 304 S.S.	LIST PRICE	SIZE	BOX	APPROX. WT. LBS.	PART # 316 S.S.	LIST PRICE
62250	---	1/8"	25	0.07	63250	---
62251	---	1/4"	25	0.07	63251	---
62252	---	3/8"	25	0.11	63252	---
62253	---	1/2"	25	0.20	63253	---
62254	---	3/4"	25	0.29	63254	---
62255	---	1"	10	0.42	63255	---
62256	---	1-1/4"	5	0.66	63256	---
62257	---	1-1/2"	5	0.99	63257	---
62258	---	2"	3	1.43	63258	---
62259	---	2-1/2"	1	1.43		
62260	---	3"	1	3.66	63260	---
62261	---	4"	1	7.19	63261	---

CROSS 304 & 316 150#



PART # 304 S.S.	LIST PRICE	SIZE	BOX	APPROX. WT. LBS.	PART # 316 S.S.	LIST PRICE
		1/8"	25	0.06	63390	---
62391	---	1/4"	25	0.09	63391	---
62392	---	3/8"	25	0.13	63392	---
62393	---	1/2"	25	0.29	63393	---
62394	---	3/4"	10	0.44	63394	---
62395	---	1"	10	0.74	63395	---
62396	---	1-1/4"	5	1.25		---
62397	---	1-1/2"	5	1.53		---
62398	---	2"	1	2.28		---

HEX NIPPLE 304 & 316 150#



PART # 304 S.S.	LIST PRICE	SIZE	BOX	APPROX. WT. LBS.	PART # 316 S.S.	LIST PRICE
62720	---	1/8"	1	0.02	63720	---
62721	---	1/4"	1	0.04	63721	---
62722	---	3/8"	1	0.07	63722	---
62723	---	1/2"	1	0.11	63723	---
62724	---	3/4"	1	0.18	63724	---
62725	---	1"	1	0.22	63725	---
62726	---	1-1/4"	1	0.37	63726	---
62727	---	1-1/2"	1	0.46	63727	---
62728	---	2"	1	0.61	63728	---

REDUCING HEX NIPPLE 304 & 316 150#



PART # 304 S.S.	LIST PRICE	SIZE	BOX	APPROX. WT. LBS.	PART # 316 S.S.	LIST PRICE
62740	---	1/4" x 1/8"	1	0.04	63740	---
62741	---	3/8" x 1/8"	1	0.07		---
62742	---	3/8" x 1/4"	1	0.07	63742	---
62744	---	1/2" x 1/4"	1	0.09	63744	---
62745	---	1/2" x 3/8"	1	0.11	63745	---
62748	---	3/4" x 3/8"	1	0.15	63748	---
62749	---	3/4" x 1/2"	1	0.15	63749	---

WARNING: This product can expose you to chemicals, including Nickel, which are known to the State of California to cause cancer.
 For more information, visit www.P65Warnings.ca.gov

304 AND 316 150# SS FITTINGS

FITTINGS AND NIPPLES

COUPLING 304 & 316 150#



PART # 304 S.S.	LIST PRICE	SIZE*	BOX	APPROX. WT. LBS.	PART # 316 S.S.	LIST PRICE
62410	---	1/8"	25	0.03	63410	---
62411	---	1/4"	25	0.06	63411	---
62412	---	3/8"	25	0.07	63412	---
62413	---	1/2"	25	0.13	63413	---
62414	---	3/4"	25	0.18	63414	---
62415	---	1"	25	0.24	63415	---
62416	---	1-1/4"	10	0.44	63416	---
62417	---	1-1/2"	10	0.51	63417	---
62418	---	2"	5	0.79	63418	---
62419	---	2-1/2"	1	1.28		
62420	---	3"	1	1.87	63420	---
62421	---	4"	1	2.80	63421	---

REDUCING COUPLING 304 & 316 150#



PART # 304 S.S.	LIST PRICE	SIZE	BOX	APPROX. WT. LBS.	PART # 316 S.S.	LIST PRICE
62430	---	1/4" x 1/8"	25	0.04	63430	---
62431	---	3/8" x 1/8"	25	0.04	63431	---
62432	---	3/8" x 1/4"	25	0.04	63432	---
62433	---	1/2" x 1/8"	25	0.09	63433	---
62434	---	1/2" x 1/4"	25	0.09	63434	---
62435	---	1/2" x 3/8"	25	0.09	63435	---
62455	---	3/4" x 1/8"	25	0.13	63455	---
62436	---	3/4" x 1/4"	25	0.11	63436	---
62437	---	3/4" x 3/8"	25	0.13	63437	---
62438	---	3/4" x 1/2"	25	0.15	63438	---
		1" x 1/4"	25	0.25	63459	---
62440	---	1" x 3/8"	25	0.22	63440	---
62441	---	1" x 1/2"	25	0.24	63441	---
62442	---	1" x 3/4"	25	0.24	63442	---
62445	---	1-1/4" x 3/4"	10	0.33	63445	---
62446	---	1-1/4" x 1"	10	0.35	63446	---
62447	---	1-1/2" x 1/2"	10	0.40	63447	---
62448	---	1-1/2" x 3/4"	10	0.42	63448	---
62449	---	1-1/2" x 1"	10	0.44	63449	---
62450	---	1-1/2" x 1-1/4"	10	0.46	63450	---
62459		2" x 1/2"				
62451	---	2" x 3/4"				
62452	---	2" x 1"	5	0.57	63452	---
62453	---	2" x 1-1/4"	5	0.62	63453	---
62454	---	2" x 1-1/2"	5	0.62	63454	---
62462		2-1/2" x 2"				
62428	---	3" x 1"	1	1.82		
62456	---	3" x 2"	1	2.25		
62457		4" x 3"				

OD MACHINED COUPLING 304 & 316 150#

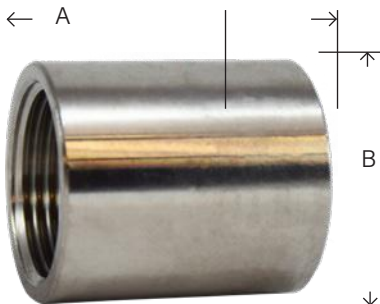

PART # 304 S.S.	LIST PRICE	SIZE	A	B	BOX	APPROX. WT. LBS.	PART # 316 S.S.	LIST PRICE
62410B	---	1/8"	0.76	0.56	25	0.04	63410B	---
62411B	---	1/4"	0.94	0.71	25	0.04	63411B	---
62412B	---	3/8"	0.98	0.84	25	0.07	63412B	---
62413B	---	1/2"	1.33	1.01	25	0.09	63413B	---
62414B	---	3/4"	1.41	1.27	25	0.16	63414B	---
62415B	---	1"	1.69	1.54	10	0.21	63415B	---
62416B	---	1-1/4"	1.93	1.90	10	0.31	63416B	---
62417B	---	1-1/2"	1.93	2.16	5	0.41	63417B	---
62418B	---	2"	1.96	2.66	5	0.68	63418B	---
62420B	---	3"	3.23	3.76	1			

WARNING: This product can expose you to chemicals, including Nickel, which are known to the State of California to cause cancer. For more information, visit www.P65Warnings.ca.gov

FITTINGS & NIPPLES

304 AND 316 150# SS FITTINGS

FITTINGS AND NIPPLES

HALF COUPLING 304 & 316 150#

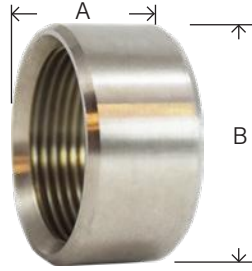

PART # 304 S.S.	LIST PRICE	SIZE	A	B	BOX	APPROX. WT. LBS.	PART # 316 S.S.	LIST PRICE
62770		1/8"						
62771	---	1/4"	0.39	0.70	25	0.02	63771	---
62772	---	3/8"	0.45	0.82	25	0.02		---
62773	---	1/2"	0.57	1.02	25	0.09	63773	---
62774	---	3/4"	0.67	1.22	25	0.11		---
62775	---	1"	0.79	1.47	25	0.13	63775	---
62776	---	1-1/4"	0.86	1.88	10	0.24		---
62777	---	1-1/2"	0.94	2.10	10	0.26		---
62778	---	2"	1.06	2.60	5	0.44	63778	---
62779		3"						

UNION 304 & 316 150#

• Stainless Steel Seat



PART # 304 S.S.	LIST PRICE	SIZE	BOX	APPROX. WT. LBS.	PART # 316 S.S.	LIST PRICE
62600	---	1/8"	25	0.09		---
62601	---	1/4"	25	0.13	63601	---
62602	---	3/8"	25	0.22	63602	---
62603	---	1/2"	25	0.26	63603	---
62604	---	3/4"	25	0.46	63604	---
62605	---	1"	10	0.60	63605	---
62606	---	1-1/4"	5	0.90	63606	---
62607	---	1-1/2"	5	1.10	63607	---
62608	---	2"	1	1.81	63608	---
62609		2-1/2"				
62610	---	3"	1	3.40		---

CAP - CAST 304 & 316 150#



PART # 304 S.S.	LIST PRICE	SIZE	BOX	APPROX. WT. LBS.	PART # 316 S.S.	LIST PRICE
62470	---	1/8"	25	0.02	63470	---
62471	---	1/4"	25	0.02	63471	---
62472	---	3/8"	25	0.04	63472	---
62473	---	1/2"	25	0.07	63473	---
62474	---	3/4"	25	0.11	63474	---
62475	---	1"	10	0.18	63475	---
62476	---	1-1/4"	10	0.29	63476	---
62477	---	1-1/2"	10	0.40	63477	---
62478	---	2"	10	0.60	63478	---
62480	---	3"	1	1.28	63480	---
62481	---	4"	1	1.54		

HEX CAP - BARSTOCK 304 & 316 150#



PART # 304 S.S.	LIST PRICE	SIZE	BOX	APPROX. WT. LBS.	PART # 316 S.S.	LIST PRICE
62075	---	1/8"	25	0.04	63075	---
62076	---	1/4"	25	0.09	63076	---
62077	---	3/8"	25	0.11		---
62078	---	1/2"	25	0.13	63078	---
62079	---	3/4"	25	0.22		---

WARNING: This product can expose you to chemicals, including Nickel, which are known to the State of California to cause cancer. For more information, visit www.P65Warnings.ca.gov

304 AND 316 150# SS FITTINGS

FITTINGS AND NIPPLES

HEX BUSHING 304 & 316 150#



stainless steel:

- barbed for plastic pipe
- Well Couplings
- merchant couplings
- See End of Bronze Fitting Section

PART # 304 S.S.	LIST PRICE	SIZE M X F	BOX	APPROX. WT. LBS.	PART # 316 S.S.	LIST PRICE
62500	---	1/4" x 1/8"	25	0.04	63500	---
62501	---	3/8" x 1/8"	25	0.04	63501	---
62502	---	3/8" x 1/4"	25	0.04	63502	---
62503	---	1/2" x 1/8"	25	0.09		
62504	---	1/2" x 1/4"	25	0.09	63504	---
62505	---	1/2" x 3/8"	25	0.11	63505	---
62506	---	3/4" x 1/8"	25	0.13	63506	---
62507	---	3/4" x 1/4"	25	0.15	63507	---
62508	---	3/4" x 3/8"	25	0.15	63508	---
62509	---	3/4" x 1/2"	25	0.15	63509	---
62557	---	1" x 1/8"	25	0.27		
62510	---	1" x 1/4"	25	0.22	63510	---
62511	---	1" x 3/8"	25	0.24	63511	---
62512	---	1" x 1/2"	25	0.24	63512	---
62513	---	1" x 3/4"	25	0.24	63513	---
62515	---	1-1/4" x 3/8"	25	0.37		
62516	---	1-1/4" x 1/2"	25	0.37	63516	---
62517	---	1-1/4" x 3/4"	25	0.37	63517	---
62518	---	1-1/4" x 1"	25	0.37	63518	---
62521	---	1-1/2" x 1/2"	25	0.44	63521	---
62522	---	1-1/2" x 3/4"	25	0.46	63522	---
62532	---	1-1/2" x 1"	25	0.49	63523	---
62524	---	1-1/2" x 1-1/4"	25	0.46	63524	---
62559	---	2" x 1/4"	10	0.95	63526	
62527	---	2" x 1/2"	10	0.66	63527	---
62528	---	2" x 3/4"	10	0.66	63528	---
62529	---	2" x 1"	10	0.66	63529	---
62530	---	2" x 1-1/4"	10	0.68	63530	---
62531	---	2" x 1-1/2"	10	0.68	63531	---
62534	---	2-1/2" x 1-1/2"	5	1.23	63534	---
62535	---	2-1/2" x 2"	5	1.21	63535	---
		3" x 1"	5	2.20	63550	---
62537	---	3" x 1-1/2"	5	1.97	63537	---
62538	---	3" x 2"	5	1.72	63538	---
62539	---	3" x 2-1/2"	5	1.81	63539	
		4" x 2"	1	3.72	63541	---
62543	---	4" x 3"	1	2.43	63543	---

BULKHEAD FITTINGS - STAINLESS STEEL 316 NPT (3/4-2")



PART #	SIZE	HOLE SIZE	HEX	LENGTH	LIST PRICE
63214	3/4"	1-5/8"	2-15/32"	1-13/16"	---
63215	1"	2-1/4"	3-1/16"	2-7/8"	---
63216	1-1/4"	2-1/4"	3-1/16"	2-3/8"	---
63217	1-1/2"	3"	4-1/4"	2-5/8"	---
63218	2"	3"	4-1/4"	2-5/8"	---

WARNING: This product can expose you to chemicals, including Nickel, which are known to the State of California to cause cancer. For more information, visit www.P65Warnings.ca.gov

304 AND 316 150# SS FITTINGS

FITTINGS AND NIPPLES

HEX LOCKNUT

304 & 316 150#

• Straight Thread



PART #304 S.S	LIST PRICE	SIZE	BOX	APPROX. WT. LBS.
62700	---	1/8"	25	0.02
62701	---	1/4"	25	0.05
62702	---	3/8"	25	0.06
62703	---	1/2"	25	0.07
62704	---	3/4"	25	0.11
62705	---	1"	25	0.15
62706	---	1-1/4"	25	0.22

CORED SQUARE HEAD PLUG

304 & 316 150#



PART # 304 S.S	LIST PRICE	SIZE	BOX	APPROX. WT. LBS.	PART # 316 S.S.	LIST PRICE
62670	---	1/8"	25	0.02	63670	---
62671	---	1/4"	25	0.03	63671	---
62672	---	3/8"	25	0.04	63672	---
62653	---	1/2"	25	0.06	63653	---
62654	---	3/4"	25	0.13	63654	---
62655	---	1"	25	0.20	63655	---
62656	---	1-1/4"	25	0.32	63656	---
62657	---	1-1/2"	10	0.41	63657	---
62658	---	2"	10	0.65	63658	---
62660	---	3"	1	0.88		

CORED HEX HEAD PLUG

304 & 316 150#



PART # 304 S.S	LIST PRICE	SIZE	BOX	APPROX. WT. LBS.	PART # 316 S.S.	LIST PRICE
62630	---	1/8"	25	0.02	63630	---
62631	---	1/4"	25	0.02	63631	---
62632	---	3/8"	25	0.04	63632	---
62633	---	1/2"	25	0.07	63633	---
62634	---	3/4"	25	0.11	63634	---
62635	---	1"	25	0.20	63635	---
62636	---	1-1/4"	25	0.31	63636	---
62637	---	1-1/2"	10	0.44	63637	---
62638	---	2"	10	0.65	63638	---
62640		3"				

HOSE NIPPLE

304 & 316 150#



HOSE BARB X MALE PIPE

PART # 304 S.S	LIST PRICE	HOSE I.D. X MALE PIPE	BOX	APPROX. WT. LBS.	PART # 316 S.S.	LIST PRICE
73951	---	1/4"	1	0.04	973951	---
73952	---	3/8"	1	0.07	973952	---
73953	---	1/2"	1	0.13	973953	---
73954	---	3/4"	1	0.20	973954	---
73955	---	1"	1	0.33	973955	---
73956	---	1-1/4"	1	0.47	973956	---
73957	---	1-1/2"	1	0.67	973957	---
73958	---	2"	1	0.88	973958	---
73959	---	2-1/2"	1	1.45	973959	---
73960	---	3"	1	1.94	973990	---
		4"	1	3.57	973991	---

WARNING: This product can expose you to chemicals, including Nickel, which are known to the State of California to cause cancer. For more information, visit www.P65Warnings.ca.gov

304 AND 316 150# SS FITTINGS

FITTINGS AND NIPPLES

REDUCING HOSE NIPPLE

304 150#



HOSE BARB X MALE PIPE

PART # 304 S.S	HOSE I.D. X MALE PIPE	BOX	APPROX. WT. LBS.	LIST PRICE
73970	1/4" x 1/8"	1	0.04	---
73971	3/8" x 1/4"	1	0.07	---
73972	1/2" x 3/8"	1	0.13	---
73973	1/2" x 1/4"	1	0.13	---
73974	3/4" x 1/2"	1	0.20	---
73975	1" x 3/4"	1	0.33	---
73976	1" x 1/2"	1	0.33	---
73977	1-1/4" x 1"	1	0.46	---
73979	1-1/2" x 1-1/4"	1	0.66	---
73980	1-1/2" x 1"	1	0.66	---
73982	2" x 1-1/4"	1	0.88	---

SOLID HEX HEAD PLUG

316 150#



PART # 316 S.S	SIZE	BOX	APPROX. WT. LBS.	LIST PRICE
63660	1/8"	25	0.04	---
63661	1/4"	25	0.06	---
63662	3/8"	25	0.08	---
63663	1/2"	25	0.12	---
63664	3/4"	25	0.15	---
63665	1"	25	0.24	---

HEX SOCKET PLUG - BARSTOCK

316 150#



PART # 316 S.S	SIZE	BOX	APPROX. WT. LBS.	LIST PRICE
63760	1/8 "	1	0.05	---
63761	1/4 "	1	0.07	---
63762	3/8 "	1	0.10	---
63763	1/2 "	1	0.14	---
63764	3/4 "	1	0.21	---
63765	1"	1	0.24	---

SOLID SQUARE HEAD PLUG

316 150#V



PART # 316 S.S	SIZE	BOX	APPROX. WT. LBS.	LIST PRICE
63680	1/8"	25	0.04	---
63681	1/4"	25	0.04	---
63682	3/8"	25	0.05	---
63683	1/2"	25	0.06	---
63684	3/4"	25	0.12	---

WARNING: This product can expose you to chemicals, including Nickel, which are known to the State of California to cause cancer. For more information, visit www.P65Warnings.ca.gov

FITTINGS & NIPPLES

BLACK AND GALVANIZED SCH 40

FITTINGS AND NIPPLES

**BLACK AND GALVANIZED STEEL NIPPLES****Product Specifications**

Welded steel pipe nipples both galvanized and black in diameters ranging from 1/8" up to 4" in lengths from close to 12" and cut-pipe up to 120". -200°-150° Temp Rating.

Technical Specifications

Standards: Product complies with ASTM A-53, A-733 and ANSI B1.20.1 for threading, dimensions and pipe specifications.

Pipe: Complies with ASTM A-53 mill tested schedule 40 and 80 for both Welded & Seamless Meets ANSI B36.1. All pipe is hydrostatic tested.

Galvanized: Zinc coating applied by hot dipped. Galvanized complying with ASTM A-123, NSF approved, RoHS compliant.

Black: Protected against oxidation with varnish coating.

Cutting Procedure: All pipe is roller cut. A visual inspection of seams, excessive galvanizing, mid-welds, poor galvanizing, bends, roundness, under and over weight of the pipe is made at the time it is cut. This is done for every length of pipe. Pipe lengths are cut to a tolerance of + or - 1/16" of the actual length.

Threading Procedure:

All pipe is chaser thread cut to American Standard Tapered Pipe Thread standards. This is 3/4" taper per foot. Pipe is visually inspected for roundness of threads and other visual faults as it is removed from the threading machine.

SCHEDULE 80 XXS SEAMLESS

- ASTM A106 Grade B Seamless Pipe
- ASTM A 53
- WWN 351
- Standard NPT Tapered Pipe Threads as per ANSI B 1.20.1 Specification

XXS SEAMLESS

WARNING: This product can expose you to chemicals, including Nickel, which are known to the State of California to cause cancer. For more information, visit www.P65Warnings.ca.gov

BLACK AND GALVANIZED SCH 40

FITTINGS AND NIPPLES

1/8" - 27

Wall Thickness 0.068 - GradeB - Test Pressure 700
PSI - Thread Length 0.39



1/8" DIAMETER
SCH 40 WELDED



PART # GALV	LIST PRICE	LENGTH	BOX/CASE	APPROX. WT. LBS.	PART # BLACK	LIST PRICE
56001	---	X Close (3/4")	50/600	0.02	57001	---
56002	---	x 1-1/2"	50/600	0.03	57002	---
56003	---	x 2"	50/500	0.04	57003	---
56004	---	x 2-1/2"	100/400	0.06	57004	---
56005	---	x 3	50/300	0.07	57005	---
56006	---	x 3-1/2"	50/300	0.08	57006	---
56007	---	x 4"	50/300	0.09	57007	---
56008	---	x 4-1/2"	50/300	0.10	57008	---
56009	---	x 5"	50/300	0.11	57009	---
56010	---	x 5-1/2"	50/300	0.12	57010	---
56011	---	x 6"	50/300	0.13	57011	---
56012	---	x 7"	50/300	0.15	57012	---
56013	---	x 8"	50/300	0.18	57013	---
	---	x 9"	50/300	0.21	57014	---
56015	---	x 10"	50/300	0.25	57015	---
56017	---	x 12"	50/300	0.29	57017	---

1/4"-18

Wall Thickness 0.068 - GradeB - Test Pressure 700
PSI - Thread Length 0.39



1/4" DIAMETER
SCH 40 WELDED



PART # GALV	LIST PRICE	LENGTH	BOX/CASE	APPROX. WT. LBS.	PART # BLACK	LIST PRICE
56020	---	X Close (7/8")	50/600	0.04	57020	---
56021	---	x 1-1/2"	125/500	0.06	57021	---
56022	---	x 2"	125/500	0.06	57022	---
56023	---	x 2-1/2"	100/400	0.08	57023	---
56024	---	x 3	50/300	0.10	57024	---
56025	---	x 3-1/2"	50/300	0.12	57025	---
56026	---	x 4"	50/300	0.14	57026	---
56027	---	x 4-1/2"	50/300	0.17	57027	---
56028	---	x 5"	50/300	0.19	57028	---
56029	---	x 5-1/2"	50/300	0.21	57029	---
56030	---	x 6"	50/300	0.23	57030	---
56031	---	x 7"	50/100	0.27	57031	---
56032	---	x 8"	50/100	0.31	57032	---
	---	x 9"	50/100	0.35	57033	---
56034	---	x 10"	50/100	0.40	57034	---
56035	---	x 11"	50/100	0.44	57035	---
56036	---	x 12"	50/100	0.48	57036	---
56038	---	x 18"	50/100	0.54		

WARNING: This product can expose you to chemicals, including Nickel, which are known to the State of California to cause cancer.
 For more information, visit www.P65Warnings.ca.gov

FITTINGS & NIPPLES

BLACK AND GALVANIZED SCH 40

FITTINGS AND NIPPLES



**3/8" DIAMETER
SCH 40 WELDED**
Wall Thickness 0.091 -
Grade B - Test Pressure 700
PSI - Thread Length 0.6



PART # GALV	LIST PRICE	LENGTH	BOX/CASE	APPROX. WT. LBS.	PART # BLACK	LIST PRICE
56040	---	X Close (1")	50/600	0.05	57040	---
56041	---	x 1-1/2"	125/500	0.07	57041	---
56042	---	x 2"	125/500	0.08	57042	---
56043	---	x 2-1/2"	100/400	0.11	57043	---
56044	---	x 3"	50/300	0.13	57044	---
56045	---	x 3-1/2"	50/300	0.16	57045	---
56046	---	x 4"	50/300	0.19	57046	---
56047	---	x 4-1/2"	50/200	0.21	57047	---
56048	---	x 5"	50/150	0.24	57048	---
56049	---	x 5-1/2"	50/150	0.27	57049	---
56050	---	x 6"	50/100	0.29	57050	---
56051	---	x 7"	50/100	0.35	57051	---
56052	---	x 8"	50/100	0.40	57052	---
	---	x 9"	50/100	0.45	57053	---
56054	---	x 10"	50/100	0.51	57054	---
56055	---	x 11"	50/100	0.56	57055	---
56056	---	x 12"	50/100	0.62	57056	---
56430	---	x 18"	5/10	0.71	57430	---
		x 24"	1/1	1.02	57431	---
		x 36"	1/1	1.54	57433	----



**1/2" DIAMETER
SCH 40 WELDED**
Wall Thickness 0.109 -
Grade B - Test Pressure
700 PSI - Thread Length
0.78



PART # GALV	LIST PRICE	LENGTH	BOX/CASE	APPROX. WT. LBS.	PART # BLACK	LIST PRICE
56060	---	X Close (1-1/8")	50/600	0.08	57060	---
56061	---	x 1-1/2"	125/500	0.08	57061	---
56062	---	x 2"	125/500	0.12	57062	---
56063	---	x 2-1/2"	100/400	0.15	57063	---
56064	---	x 3"	50/300	0.19	57064	---
56065	---	x 3-1/2"	50/300	0.23	57065	---
56066	---	x 4"	50/300	0.27	57066	---
56067	---	x 4-1/2"	50/200	0.30	57067	---
56068	---	x 5"	50/150	0.34	57068	---
56069	---	x 5-1/2"	50/150	0.38	57069	---
56070	---	x 6"	50/100	0.42	57070	---
56071	---	x 7"	50/100	0.49	57071	---
56072	---	x 8"	50/100	0.57	57072	---
56073	---	x 9"	50/100	0.65	57073	---
56074	---	x 10"	50/100	0.72	57074	---
56075	---	x 11"	50/100	0.80	57075	---
56076	---	x 12"	40/80	0.87	57076	---
56240	---	x 18"	1/3	1.29	57240	---
56241	---	x 24"	1/3	1.74	57241	---
56242	---	x 30"	1/3	2.16	57242	---
56243	---	x 36"	1/3	2.61	57243	---
56245	---	x 48"	1/3	3.48	57245	---
56246	---	x 60"	1/3	4.35	57246	---
56247	---	x 72"	1/3	5.22	57247	---

WARNING: This product can expose you to chemicals, including Nickel, which are known to the State of California to cause cancer.
 For more information, visit www.P65Warnings.ca.gov

BLACK AND GALVANIZED SCH 40

FITTINGS AND NIPPLES



3/4" DIAMETER SCH 40 WELDED

Wall Thickness 0.113 -
Grade B - Test Pres-
sure 700 PSI - Thread
Length 0.79



Part # Galv	List Price	Length	Box/Case	Approx. Wt. Lbs.	Part # Black	List Price
56080	---	X Close (1-3/8")	50/300	0.13	57080	---
56081	---	x 1-1/2"	125/250	0.10	57081	---
56082	---	x 2"	125/250	0.15	57082	---
56083	---	x 2-1/2"	50/250	0.20	57083	---
56084	---	x 3"	50/200	0.24	57084	---
56085	---	x 3-1/2"	50/150	0.29	57085	---
56086	---	x 4"	50/150	0.34	57086	---
56087	---	x 4-1/2"	50/150	0.39	57087	---
56088	---	x 5"	50/150	0.43	57088	---
56089	---	x 5-1/2"	60/120	0.48	57089	---
56090	---	x 6"	50/100	0.53	57090	---
56091	---	x 7"	50/100	0.63	57091	---
56092	---	x 8"	50/100	0.72	57092	---
56093	---	x 9"	40/80	0.82	57093	---
56094	---	x 10"	40/80	0.91	57094	---
56095	---	x 11"	30/60	1.01	57095	---
56096	---	x 12"	30/60	1.10	57096	---
56250	---	x 18"	1/3	1.63	57250	---
56251	---	x 24"	1/3	2.20	57251	---
56252	---	x 30"	1/3	2.73	57252	---
56253	---	x 36"	1/3	3.30	57253	---
56255	---	x 48"	1/3	4.40	57255	---
56256	---	x 60"	1/3	5.50	57256	---
56257	---	x 72"	1/3	6.60	57257	---

WARNING: This product can expose you to chemicals, including Nickel, which are known to the State of California to cause cancer. For more information, visit www.P65Warnings.ca.gov

FITTINGS & NIPPLES

BLACK AND GALVANIZED SCH 40

FITTINGS AND NIPPLES



1" DIAMETER SCH 40 WELDED

Wall Thickness 0.133 -
Grade B - Test Pressure
700 PSI - Thread Length
0.98



PART # GALV	LIST PRICE	LENGTH	BOX/CASE	APPROX. WT. LBS.	PART # BLACK	LIST PRICE
56100	---	X Close (1-1/2")	50/200	0.16	57100	---
56101	---	x 2"	50/150	0.23	57101	---
56102	---	x 2-1/2"	50/150	0.29	57102	---
56103	---	x 3"	50/100	0.36	57103	---
56104	---	x 3-1/2"	50/100	0.43	57104	---
56105	---	x 4"	50/100	0.50	57105	---
56106	---	x 4-1/2"	50/100	0.56	57106	---
56107	---	x 5"	50/100	0.63	57107	---
56108	---	x 5-1/2"	50/100	0.70	57108	---
56109	---	x 6"	40/80	0.77	57109	---
56110	---	x 7"	25/50	0.90	57110	---
56111	---	x 8"	25/50	1.03	57111	---
56112	---	x 9"	15/30	1.17	57112	---
56113	---	x 10"	15/30	1.30	57113	---
56114	---	x 11"	15/30	1.44	57114	---
56115	---	x 12"	15/30	1.57	57115	---
56260	---	x 18"	1/3	2.34	57260	---
56261	---	x 24"	1/3	3.14	57261	---
56262	---	x 30"	1/3	3.91	57262	---
56263	---	x 36"	1/3	4.71	57263	---
56265	---	x 48"	1/3	6.28	57265	---
56266	---	x 60"	1/3	7.85	57266	---
56267	---	x 72"	1/3	9.42	57267	---

WARNING: This product can expose you to chemicals, including Nickel, which are known to the State of California to cause cancer. For more information, visit www.P65Warnings.ca.gov

BLACK AND GALVANIZED SCH 40

FITTINGS AND NIPPLES



1-1/4" DIAMETER SCH 40 WELDED

Wall Thickness 0.14 - Grade B -
Test Pressure 1300 PSI -
Thread Length 1.01



PART # GALV	LIST PRICE	LENGTH	BOX/CASE	APPROX. WT. LBS.	PART # BLACK	LIST PRICE
56120	---	X Close (1-5/8")	50/100	0.25	57120	---
56121	---	x 2"	50/100	0.32	57121	---
56122	---	x 2-1/2"	50/100	0.41	57122	---
56123	---	x 3"	50/100	0.50	57123	---
56124	---	x 3-1/2"	30/60	0.60	57124	---
56125	---	x 4"	30/60	0.69	57125	---
56126	---	x 4-1/2"	30/60	0.78	57126	---
56127	---	x 5"	25/50	0.87	57127	---
56128	---	x 5-1/2"	25/50	0.96	57128	---
56129	---	x 6"	25/50	1.06	57129	---
56130	---	x 7"	15/30	1.24	57130	---
56131	---	x 8"	15/30	1.42	57131	---
56132	---	x 9"	15/30	1.61	57132	---
56133	---	x 10"	15/30	1.79	57133	---
56134	---	x 11"	10/20	1.97	57134	---
56135	---	x 12"	10/20	2.16	57135	---
56270	---	x 18"	1/3	3.22	57270	---
56271	---	x 24"	1/3	4.32	57271	---
56272	---	x 30"	1/3	3.22	57272	---
56273	---	x 36"	1/3	6.48	57273	---
56275	---	x 48"			57275	---
		x 48"	1/3	8.64	57275	---
56276		x 60"	1/3	10.80	57276	



1-1/2" DIAMETER SCH 40 WELDED

Wall Thickness 0.145 - Grade B -
Test Pressure 1300 PSI - Thread
Length 1.03



PART # GALV	LIST PRICE	LENGTH	BOX/CASE	APPROX. WT. LBS.	PART # BLACK	LIST PRICE
56140	---	X Close (1-3/4")	50/100	0.31	57140	---
56141	---	x 2"	40/80	0.37	57141	---
56142	---	x 2-1/2"	40/80	0.47	57142	---
56143	---	x 3"	40/80	0.58	57143	---
56144	---	x 3-1/2"	25/50	0.68	57144	---
56145	---	x 4"	25/50	0.78	57145	---
56146	---	x 4-1/2"	25/50	0.89	57146	---
56147	---	x 5"	25/50	1.10	57147	---
56148	---	x 5-1/2"	20/40	1.10	57148	---
56149	---	x 6"	15/30	1.20	57149	---
56150	---	x 7"	15/30	1.41	57150	---
56151	---	x 8"	15/30	1.62	57151	---
56152	---	x 9"	15/30	1.83	57152	---
56153	---	x 10"	1/20	2.04	57153	---
		x 11"	1/20	2.25	57154	---
56155	---	x 12"	1/20	2.46	57155	---
56280	---	x 18"	1/3	3.66	57280	---
56281	---	x 24"	1/3	4.92	57281	---
56282	---	x 30"	1/3	6.12	57282	---
56283	---	x 36"	1/3	7.38	57283	---
56285	---	x 48"	1/3	9.84	57285	---
		x 60"			57286	---

WARNING: This product can expose you to chemicals, including Nickel, which are known to the State of California to cause cancer.
 For more information, visit www.P65Warnings.ca.gov

FITTINGS & NIPPLES

BLACK AND GALVANIZED SCH 40

FITTINGS AND NIPPLES



**2" DIAMETER
SCH 40 WELDED**
Wall Thickness 0.154 -
Grade B - Test Pressure
2500 PSI - Thread Length
1.06



PART # GALV	LIST PRICE	LENGTH	BOX/CASE	APPROX. WT. LBS.	PART # BLACK	LIST PRICE
56160	---	X Close (2")	40/80	0.55	57160	---
56161	---	x 2-1/2"	25/50	0.70	57161	---
56162	---	x 3"	25/50	0.86	57162	---
56163	---	x 3-1/2"	1/30	1.01	57163	---
56164	---	x 4"	1/30	1.16	57164	---
56165	---	x 4-1/2"	1/25	1.31	57165	---
56166	---	x 5"	1/30	1.47	57166	---
56167	---	x 5-1/2"	1/30	1.62	57167	---
56168	---	x 6"	1/20	1.77	57168	---
56169	---	x 7"	1/20	2.08	57169	---
56170	---	x 8"	1/20	2.39	57170	---
56171	---	x 9"	1/10	2.70	57171	---
56172	---	x 10"	1/10	3.00	57172	---
	---	x 11"	1/10	3.31	57173	---
56174	---	x 12"	1/10	3.62	57174	---
56290	---	x 18"	1/3	5.39	57290	---
56291	---	x 24"	1/3	5.26	57291	---
56292	---	x 30"	1/3	7.03	57292	---
56293	---	x 36"	1/3	10.86	57293	---
	----	x 42"	1/3	12.63		---
56295	---	x 48"	1/3	14.48	57295	---
56296	---	x 60"	1/3	18.10	57296	---
56297	---	x 72"	1/3	18.10	57297	---



**2-1/2" DIAMETER
SCH 40 WELDED**
Wall Thickness 0.203 - Grade
B - Test Pressure 2500 PSI -
Thread Length 1.57



PART # GALV	LIST PRICE	LENGTH	BOX/CASE	APPROX. WT. LBS.	PART # BLACK	LIST PRICE
56180	---	X Close (2-1/2")	1/20	1.09	57180	---
56181	---	x 3"	1/20	1.33	57181	---
56182	---	x 3-1/2"	1/20	1.57	57182	---
56183	---	x 4"	1/20	1.82	57183	---
56184	---	x 4-1/2"	1/20	2.06	57184	---
56185	---	x 5"	1/20	2.30	57185	---
56186	---	x 5-1/2"	1/10	2.54	57186	---
56187	---	x 6"	1/10	2.78	57187	---
	---	x 7"	1/10	3.27	57188	---
56189	---	x 8"	1/10	3.75	57189	---
56191	---	x 10"	1/8	4.72	57191	---
56193	---	x 12"	1/8	5.69	57193	---

WARNING: This product can expose you to chemicals, including Nickel, which are known to the State of California to cause cancer.
 For more information, visit www.P65Warnings.ca.gov

BLACK AND GALVANIZED SCH 40

FITTINGS AND NIPPLES



**3" DIAMETER
SCH 40 WELDED**
Wall Thickness 0.216 - Grade
B - Test Pressure 2500 PSI -
Thread Length 1.64



PART # GALV	LIST PRICE	LENGTH	BOX/CASE	APPROX. WT. LBS.	PART # BLACK	LIST PRICE
56200	---	X Close (2-5/8")	1/20	1.52	57200	---
56201	---	x 3"	1/20	1.76	57201	---
56202	---	x 3-1/2"	1/10	2.08	57202	---
56203	---	x 4"	1/10	2.39	57203	---
56204	---	x 4-1/2"	1/10	2.71	57204	---
56205	---	x 5"	1/10	3.03	57205	---
56206	---	x 5-1/2"	1/10	3.35	57206	---
56207	---	x 6"	1/10	3.66	57207	---
56208	---	x 7"	1/8	4.30	57208	---
56209	---	x 8"	1/8	4.93	57209	---
56210	---	x 9"	1/8	5.57	57210	---
56211	---	x 10"	1/5	6.20	57211	---
56212	---	x 11"	1/5	7.20	57212	---
56213	---	x 12"	1/5	7.47	57213	---
		x 24"	1	14.94	57311	---



**4" DIAMETER
SCH 40 WELDED**

Wall Thickness 0.237 - Grade B - Test Pres-
sure 2210 PSI - Thread Length 1.74



PART # GALV	LIST PRICE	LENGTH	BOX/CASE	APPROX. WT. LBS.	PART # BLACK	LIST PRICE
56220	---	X Close (2-7/8")	1/10	2.00	57220	---
56221	---	3-1/2"	1/8	2.21		---
56223	---	x 4"	1/8	3.41	57223	---
56224	---	x 4-1/2"	1/6	3.86	57224	---
56225	---	x 5"	1/6	4.31	57225	---
56226	---	x 5-1/2"	1/6	4.76	57226	---
56227	---	x 6"	1/6	5.21	57227	---
	---	x 7"	1/5	6.48	57330	---
56229	---	x 8"	1/5	7.01	57229	---
	---	x 9"	1/5	7.54	57331	---
56332	---	x 10"	1/5	8.14	57332	---
56228	---	x 12"	1/4	8.54	57228	---

WARNING: This product can expose you to chemicals, including Nickel, which are known to the State of California to cause cancer. For more information, visit www.P65Warnings.ca.gov

FITTINGS & NIPPLES

NIPPLES AND ASSORTMENTS

FITTINGS AND NIPPLES



6" DIAMETER SCH 40 WELDED

Wall Thickness 0.154 - Grade B - Test Pressure
2500 PSI - Thread Length 1.06



PART # GALV	LIST PRICE	LENGTH	BOX/CASE	APPROX. WT. LBS.	PART # BLACK	LIST PRICE
56300	---	X Close (3-1/8")	1/1	3.80	57300	---
		x 4"	1/1	5.30	57304	---
56301		x 6"	1/1	8.30	57301	---
		x 8"	1/1	11.30	57305	---
		x 10"			57306	---
		x 12"	1/1	17.20	57308	---



8" DIAMETER SCH 40 WELDED

Wall Thickness 0.154 - Grade B - Test Pressure
2500 PSI - Thread Length 1.06

PART #	LENGTH	BOX/CASE	APPROX. WT. LBS.	LIST PRICE
57320	X Close (3-1/8")	1/1	5.80	---
57322	x 6"	1/1	6.50	---
57326	x 10"	1/1	19.00	---
57328	x 12"	1/1	28.55	---



SCH 40 SINGLE RUN NIPPLE BLACK

PART	DESCRIPTION	CLOSE	1-1/2	2	2-1/2	3	3-1/2	4	4-1/2	5	5 1/2	6	TOTAL PCS	LIST
973570	1/2"	1	1	1	1	1	1	1	1	1	1	1	11	
973571	3/4"	1	1	1	1	1	1	1	1	1	1	1	11	
973572	1"	1		1	1	1	1	1	1	1	1	1	10	
973573	1-1/4"	1		1	1	1	1	1	1	1	1	1	10	
973574	1-1/2"	1		1	1	1	1	1	1	1	1	1	10	
973575	2"	1			1	1	1	1	1	1	1	1	9	

SCH 40 SINGLE RUN NIPPLE GALVANIZED

PART	DESCRIPTION	CLOSE	1-1/2	2	2-1/2	3	3-1/2	4	4-1/2	5	5 1/2	6	TOTAL PCS	LIST
973670	1/2"	1	1	1	1	1	1	1	1	1	1	1	11	
973671	3/4"	1	1	1	1	1	1	1	1	1	1	1	11	
973672	1"	1		1	1	1	1	1	1	1	1	1	10	
973673	1-1/4"	1		1	1	1	1	1	1	1	1	1	10	
973674	1-1/2"	1		1	1	1	1	1	1	1	1	1	10	
973675	2"	1			1	1	1	1	1	1	1	1	9	

WARNING: This product can expose you to chemicals, including Nickel, which are known to the State of California to cause cancer.
 For more information, visit www.P65Warnings.ca.gov

NIPPLES AND ASSORTMENTS

FITTINGS AND NIPPLES

STEEL NIPPLE ASSORTMENTS

B "6" ASSORTMENTS



BLACK		LENGTH											WT. TOTAL			
		CLOSE	1-1/2"	2"	2-1/2"	3"	3-1/2"	4"	4-1/2"	5"	5-1/2"	6"	LBS.	PIECES		
973567	1/2"	6	6	6	6	6	6	6	6	6	6	6	6	20	66	---
973568	3/4"	6	6	6	6	6	6	6	6	6	6	6	6	27	66	---
973569	1"	6		6	6	6	6	6	6	6	6	6	6	34	60	---

GALV.		LENGTH											WT. TOTAL			
		CLOSE	1-1/2"	2"	2-1/2"	3"	3-1/2"	4"	4-1/2"	5"	5-1/2"	6"	LBS.	PIECES		
973667	1/2"	6	6	6	6	6	6	6	6	6	6	6	6	20	66	---
973668	3/4"	6	6	6	6	6	6	6	6	6	6	6	6	27	66	---
973669	1"	6		6	6	6	6	6	6	6	6	6	6	34	60	---

STEEL TOTE TRAYS



PART #	SIZE	CAPACITY	LIST PRICE
990781	1/2"	77pcs	---
990782	3/4"	66pcs	---
990783	1"	50pcs	---
990786	1-1/4"	40pcs	---
990784	1-1/2"	30pcs	---
990785	2"	27pcs	---

WARNING: This product can expose you to chemicals, including Nickel, which are known to the State of California to cause cancer. For more information, visit www.P65Warnings.ca.gov

FITTINGS & NIPPLES

BLACK SCH 80 SEAMLESS

FITTINGS AND NIPPLES

EXTRA HEAVY SEAMLESS STEEL PIPE NIPPLES

1/8" - 27



1/8" DIAMETER SCHEDULE 80 SEAMLESS

Wall Thickness 0.094 - Grade B - Test Pressure 850 PSI - Thread Length 0.39

PART #	LENGTH	BOX/CASE	APPROX. WT. LBS.	LIST PRICE
59001SMLS	x Close	40/480	0.02	---
59002SMLS	x 1-1/2"	40/480	0.03	---
59003SMLS	x 2"	100/400	0.05	---
59004SMLS	2-1/2"	100/400	0.06	---
59005SMLS	x 3"	40/240	0.08	---
59006SMLS	x 3-1/2"	40/240	0.09	---
59007SMLS	x 4"	40/240	0.11	---
59009SMLS	x 5"	40/120	0.12	---
59010SMLS	x 5-1/2"	40/120	0.13	---
59011SMLS	x 6"	40/80	0.16	---

1/4" - 18



1/4" DIAMETER SCHEDULE 80 SEAMLESS

Wall Thickness 0.119 - Grade B - Test Pressure 850 PSI - Thread Length 0.59

PART #	LENGTH	BOX/CASE	APPROX. WT. LBS.	LIST PRICE
59020SMLS	x Close (7/8")	40 / 480	0.03	---
59021SMLS	x 1-1/2"	100 / 400	0.06	---
59022SMLS	x 2"	100 / 400	0.08	---
59023SMLS	x 2-1/2"	80 / 320	0.10	---
59024SMLS	x 3"	40 / 240	0.12	---
59025SMLS	x 3-1/2"	40 / 240	0.15	---
59026SMLS	x 4"	40 / 240	0.17	---
59027SMLS	x 4-1/2"	40 / 120	0.19	---
59028SMLS	x 5"	40 / 120	0.21	---
59029SMLS	x 5-1/2"	40 / 80	0.24	---
59030SMLS	x 6"	40 / 80	0.26	---
59032SMLS	x 8"	40 / 80	0.35	---
59034SMLS	x 10"	40 / 80	0.44	---
59036SMLS	x 12"	40 / 80	0.53	---

WARNING: This product can expose you to chemicals, including Nickel, which are known to the State of California to cause cancer. For more information, visit www.P65Warnings.ca.gov



BLACK SCH 80 SEAMLESS

FITTINGS AND NIPPLES

3/8" - 18



3/8" DIAMETER SCHEDULE 80 SEAMLESS

Wall Thickness 0.126 - Grade B - Test Pressure 850 PSI - Thread Length 0.6

PART #	LENGTH	BOX/CASE	APPROX. WT. LBS.	LIST PRICE
59040SMLS	X Close (3/8")	40 / 480	0.05	---
59041SMLS	x 1-1/2"	100 / 400	0.08	---
59042SMLS	x 2"	100 / 400	0.11	---
59043SMLS	x 2-1/2"	80 / 320	0.14	---
59044SMLS	x 3"	40 / 240	0.17	---
59045SMLS	x 3-1/2"	40 / 240	0.20	---
59046SMLS	x 4"	40 / 240	0.23	---
59047SMLS	x 4-1/2"	40 / 160	0.26	---
59048SMLS	x 5"	40 / 120	0.29	---
59049SMLS	x 5-1/2"	40 / 120	0.32	---
59050SMLS	x 6"	40 / 80	0.35	---
59056SMLS	x 12"	40/80	0.65	---

1/2" - 14



1/2" DIAMETER SCHEDULE 80 SEAMLESS

Wall Thickness 0.147 - Grade B - Test Pressure 850 PSI - Thread Length 0.78

PART #	LENGTH	BOX/CASE	APPROX. WT. LBS.	LIST PRICE
59060SMLS	X Close (1-1/8")	40 / 480	0.07	---
59061SMLS	x 1-1/2"	100 / 400	0.11	---
59062SMLS	x 2"	100 / 400	0.15	---
59063SMLS	x 2-1/2"	80 / 320	0.20	---
59064SMLS	x 3"	40 / 240	0.24	---
59065SMLS	x 3-1/2"	40 / 240	0.29	---
59066SMLS	x 4"	40 / 240	0.33	---
59067SMLS	x 4-1/2"	40 / 160	0.38	---
59068SMLS	x 5"	40 / 120	0.42	---
59069SMLS	x 5-1/2"	40 / 120	0.47	---
59070SMLS	x 6"	40 / 80	0.51	---
59071SMLS	x 7"	40 / 80	0.60	---
59072SMLS	x 8"	40 / 80	0.69	---
59074SMLS	x 10"	40 / 80	0.88	---
59076SMLS	x 12"	32 / 64	1.06	---

WARNING: This product can expose you to chemicals, including Nickel, which are known to the State of California to cause cancer. For more information, visit www.P65Warnings.ca.gov

FITTINGS & NIPPLES

BLACK SCH 80 SEAMLESS

FITTINGS AND NIPPLES

FITTINGS & NIPPLES



3/4" - 14

3/4" DIAMETER SCHEDULE 80 SEAMLESS

Wall Thickness 0.154 - Grade B - Test Pressure 850 PSI - Thread Length 0.79

PART #	LENGTH	BOX/CASE	APPROX. WT. LBS.	LIST PRICE
59080SMLS	X Close (1-3/8")	40/240	0.13	---
59081SMLS	x 1-1/2"	100/200	0.15	---
59082SMLS	x 2"	100/200	0.21	---
59083SMLS	x 2-1/2"	40/160	0.27	---
59084SMLS	x 3"	40/160	0.33	---
59085SMLS	x 3-1/2"	40/120	0.39	---
59086SMLS	x 4"	40/120	0.45	---
59087SMLS	x 4-1/2"	40/120	0.51	---
59088SMLS	x 5"	40/120	0.57	---
59089SMLS	x 5-1/2"	48/96	0.64	---
59090SMLS	x 6"	40/80	0.69	---
59091SMLS	x 7"	40/80	0.82	---
59092SMLS	x 8"	40/80	0.94	---
59094SMLS	x 10"	32/64	1.19	---
59096SMLS	x 12"	24/48	1.44	---



1" - 11 1/2

1" DIAMETER SCHEDULE 80 SEAMLESS

Wall Thickness 0.179 - Grade B - Test Pressure 850 PSI - Thread Length 0.98

PART #	LENGTH	BOX/CASE	APPROX. WT. LBS.	LIST PRICE
59100SMLS	X Close (1-1/2")	40 / 160	0.21	---
59101SMLS	x 2"	40 / 120	0.30	---
59102SMLS	x 2-1/2"	40 / 120	0.37	---
59103SMLS	x 3"	40 / 80	0.47	---
59104SMLS	x 3-1/2"	40 / 80	0.56	---
59105SMLS	x 4"	40 / 80	0.65	---
59106SMLS	x 4-1/2"	40 / 80	0.74	---
59107SMLS	x 5"	40 / 80	0.83	---
59108SMLS	x 5-1/2"	40 / 80	0.92	---
59109SMLS	x 6"	32 / 64	1.01	---
59110SMLS	x 7"	20 / 40	1.19	---
59111SMLS	x 8"	20 / 40	1.37	---
59112SMLS	x 9"	20 / 40	1.55	---
59113SMLS	x 10"	12 / 24	1.74	---
59115SMLS	x 12"	12 / 24	2.10	---

WARNING: This product can expose you to chemicals, including Nickel, which are known to the State of California to cause cancer. For more information, visit www.P65Warnings.ca.gov

BLACK SCH 80 SEAMLESS

FITTINGS AND NIPPLES



1-1/4" DIAMETER SCHEDULE 80 SEAMLESS

Wall Thickness 0.191 - Grade B - Test Pressure 1900 PSI - Thread Length 1.01

PART #	LENGTH	BOX/CASE	APPROX. WT. LBS.	LIST PRICE
59120SMLS	X Close (1-5/8")	40 / 80	0.31	---
59121SMLS	x 2"	40 / 80	0.42	---
59122SMLS	x 2-1/2"	40 / 80	0.52	---
59123SMLS	x 3"	40 / 80	0.64	---
59124SMLS	x 3-1/2"	24 / 48	0.77	---
59125SMLS	x 4"	24 / 48	0.90	---
59126SMLS	x 4-1/2"	24 / 48	1.02	---
59127SMLS	x 5"	20 / 40	1.15	---
59128SMLS	x 5-1/2"	20 / 40	1.27	---
59129SMLS	x 6"	20 / 40	1.40	---
59130SMLS	x 7"	20 / 40	1.65	---
59131SMLS	x 8"	12 / 24	1.90	---
59132SMLS	x 9"	12 / 24	2.15	---
59133SMLS	x 10"	12 / 24	2.40	---
59134SMLS	x 11"	8 / 16	2.65	---
59135SMLS	x 12"	8 / 16	2.90	---



1-1/2" DIAMETER SCHEDULE 80 SEAMLESS

Wall Thickness 0.2 - Grade B - Test Pressure 1900 PSI - Thread Length 1.03

PART #	LENGTH	BOX/CASE	APPROX. WT. LBS.	LIST PRICE
59140SMLS	X Close (1-3/4")	40 / 80	0.41	---
59141SMLS	x 2"	32 / 64	0.51	---
59142SMLS	x 2-1/2"	32 / 64	0.64	---
59143SMLS	x 3"	32 / 64	0.78	---
59144SMLS	x 3-1/2"	20 / 40	0.94	---
59145SMLS	x 4"	20 / 40	1.09	---
59146SMLS	x 4-1/2"	20 / 40	1.23	---
59147SMLS	x 5"	20 / 40	1.39	---
59148SMLS	x 5-1/2"	16 / 32	1.54	---
59149SMLS	x 6"	12 / 24	1.69	---
59150SMLS	x 7"	12 / 24	2.00	---
59151SMLS	x 8"	12 / 24	2.30	---
59153SMLS	x 10"	8 / 16	2.90	---
59155SMLS	x 12"	8 / 16	2.51	---

WARNING: This product can expose you to chemicals, including Nickel, which are known to the State of California to cause cancer. For more information, visit www.P65Warnings.ca.gov

FITTINGS & NIPPLES

BLACK SCH 80 SEAMLESS

FITTINGS AND NIPPLES



2" DIAMETER SCHEDULE 80 SEAMLESS

Wall Thickness 0.218 - Grade B - Test Pressure 2500 PSI - Thread Length 1.06

PART #	LENGTH	BOX/CASE	APPROX. WT. LBS.	LIST PRICE
59160SMLS	X Close (2")	32/64	0.30	---
59161SMLS	x 2-1/2"	20 / 40	0.80	---
59162SMLS	x 3"	20 / 40	1.10	---
59163SMLS	x 3-1/2"	12 / 24	1.31	---
59164SMLS	x 4"	12 / 24	1.52	---
59165SMLS	x 4-1/2"	12 / 24	1.72	---
59166SMLS	x 5"	12 / 24	1.94	---
59167SMLS	x 5-1/2"	12 / 24	2.15	---
59168SMLS	x 6"	8 / 16	2.35	---
59169SMLS	x 7"	8 / 16	2.78	---
59170SMLS	x 8"	8 / 16	3.19	---
59171SMLS	x 9"	1 / 8	3.62	---
59172SMLS	x 10"	1 / 8	4.03	---
59173SMLS	x 11"	1 / 8	4.44	---
59174SMLS	x 12"	1 / 8	4.87	---
59197SMLS	x 24"	1/1	9.74	---



2-1/2" DIAMETER SCHEDULE 80 SEAMLESS

Wall Thickness 0.276 - Grade B - Test Pressure 2500 PSI - Thread Length 1.57

PART #	LENGTH	BOX/CASE	APPROX. WT. LBS.	LIST PRICE
59180SMLS	x Close (2-1/2")	1 / 16	1.25	---
59181SMLS	x 3"	1 / 16	1.57	---
59182SMLS	x 3-1/2"	1 / 16	1.82	---
59183SMLS	x 4"	1 / 16	2.15	---
59184SMLS	x 4-1/2"	1 / 16	1.75	---
59185SMLS	x 5"	1 / 16	2.78	---
59186SMLS	x 5-1/2"	1 / 8	2.25	---
59187SMLS	x 6"	1 / 8	3.41	---
59188SMLS	x 7"	1 / 8	3.89	---
59189SMLS	x 8"	1 / 8	4.69	---
59190SMLS	x 9"	1 / 8	5.34	---
59191SMLS	x 10"	1 / 6	5.97	---
59192SMLS	x 11"	1 / 6	4.89	---
59193SMLS	x 12"	1 / 5	7.26	---

WARNING: This product can expose you to chemicals, including Nickel, which are known to the State of California to cause cancer. For more information, visit www.P65Warnings.ca.gov

BLACK SCH 80 SEAMLESS

FITTINGS AND NIPPLES



3" DIAMETER SCHEDULE 80 SEAMLESS

Wall Thickness 0.3 - Grade B - Test Pressure 2500 PSI - Thread Length 1.64

PART #	LENGTH	BOX/CASE	APPROX. WT. LBS.	LIST PRICE
59200SMLS	X Close (2-5/8")	1 / 16	1.79	---
59201SMLS	x 3"	1 / 16	2.11	---
59202SMLS	x 3-1/2"	1 / 16	2.55	---
59203SMLS	x 4"	1 / 8	2.89	---
59204SMLS	x 4-1/2"	1 / 8	3.30	---
59205SMLS	x 5"	1 / 8	3.73	---
59206SMLS	x 5-1/2"	1 / 8	4.17	---
59207SMLS	x 6"	1 / 8	4.57	---
59209SMLS	x 8"	1 / 6	6.29	---
59211SMLS	x 10"	1 / 4	8.01	---
59212SMLS	x 11"	1 / 4	8.85	---
59213SMLS	x 12"	1 / 4	9.72	---



4" DIAMETER SCHEDULE 80 SEAMLESS

Wall Thickness 0.337 - Grade B - Test Pressure 2800 PSI - Thread Length 1.74

PART #	LENGTH	BOX/CASE	APPROX. WT. LBS.	LIST PRICE
59220SMLS	X Close (2-7/8")	1 / 8	2.91	---
59221SMLS	x 4"	1 / 6	4.26	---
59223SMLS	x 5"	1 / 5	5.49	---
59224SMLS	x 5-1/2"			
59225SMLS	x 6"	1 / 5	6.72	---
59227SMLS	x 8"	1 / 3	9.23	---
59228SMLS	9"			
59229SMLS	x 10"	1 / 3	11.73	---
59231SMLS	x 12"	1 / 3	14.24	---



6" DIAMETER

SCHEDULE 80 SEAMLESS



8" DIAMETER

PART #	LENGTH	BOX/CASE	APPROX. WT. LBS.		PART #	LIST PRICE
			6"	8"		
59300SMLS	X Close	2	3.57	4.62	59320SMLS	---
59301SMLS	x 6"	2	14.29	16.91	59322SMLS	---
59305SMLS	x 8"	2	19.05	22.54	59324SMLS	---
59308SMLS	x 12"	2	28.57	34.18	59328SMLS	---

WARNING: This product can expose you to chemicals, including Nickel, which are known to the State of California to cause cancer. For more information, visit www.P65Warnings.ca.gov

FITTINGS & NIPPLES

BLACK EXTRA HEAVY XXS SEAMLESS

FITTINGS AND NIPPLES



1/2" DIAMETER BLACK EXTRA HEAVY XXS SEAMLESS
 Wall Thickness 0.294 - Grade B - Test Pressure 1000 PSI - Thread Length 0.79

PART #	LENGTH	BOX/CASE	APPROX. WT. LBS.	LIST PRICE
59060SMLSXX	x Close	100 / 200	0.31	---
59062SMLSXX	x 2"	100 / 200	0.58	---
59064SMLSXX	x 3"	50 / 100	0.62	---
59066SMLSXX	x 4"	50 / 100	0.66	---
59070SMLSXX	x 6"	25 / 50	0.75	---



3/4" DIAMETER DIAMETER BLACK EXTRA HEAVY XXS SEAMLESS
 Wall Thickness 0.308 - Grade B - Test Pressure 1000 PSI - Thread Length 0.79

PART #	LENGTH	BOX/CASE	APPROX. WT. LBS.	LIST PRICE
59080SMLSXX	x Close	40/240	0.55	---
59082SMLSXX	x 2"	50 / 100	0.62	---
59086SMLSXX	x 4"	25 / 50	0.68	---
59090SMLSXX	x 6"	25 / 50	0.71	---



1" DIAMETER DIAMETER BLACK EXTRA HEAVY XXS SEAMLESS
 Wall Thickness 0.358 - Grade B - Test Pressure 1000 PSI - Thread Length 0.98

PART #	LENGTH	BOX/CASE	APPROX. WT. LBS.	LIST PRICE
59100SMLSXX	x close	50 / 100	0.88	---
59101SMLSXX	x 2"	50 / 100	1.07	---
59103SMLSXX	x 3"	20/40	1.10	---
59105SMLSXX	x 4"	20 / 40	1.14	---
59109SMLSXX	x 6"	20 / 40	1.75	---



2" DIAMETER DIAMETER BLACK EXTRA HEAVY XXS SEAMLESS
 Wall Thickness 0.436 - Grade B - Test Pressure 2500 PSI - Thread Length 1.06

PART #	LENGTH	BOX/CASE	APPROX. WT. LBS.	LIST PRICE
59160SMLSXX	x close	1 / 25	1.36	---
59161SMLSXX	x 2-1/2"	1 / 20	1.67	---
59162SMLSXX	x 3"	1 / 20	2.09	---
59163SMLSXX	x 3-1/2"	1 / 12	2.51	---
59164SMLSXX	x 4"	1 / 12	2.86	---
59166SMLSXX	x 5"	1/12	3.04	---
59168SMLSXX	x 6"	1 / 11	3.20	---
59170SMLSXX	x 8"	1 / 8	5.86	---
59172SMLSXX	x 10"	1 / 8	7.31	---
59174SMLSXX	x 12"	1 / 8	9.34	---

WARNING: This product can expose you to chemicals, including Nickel, which are known to the State of California to cause cancer.
 For more information, visit www.P65Warnings.ca.gov

SCH 40 AND SCH 80 GROOVE NIPPLES

FITTINGS AND NIPPLES

THREAD X GROOVE

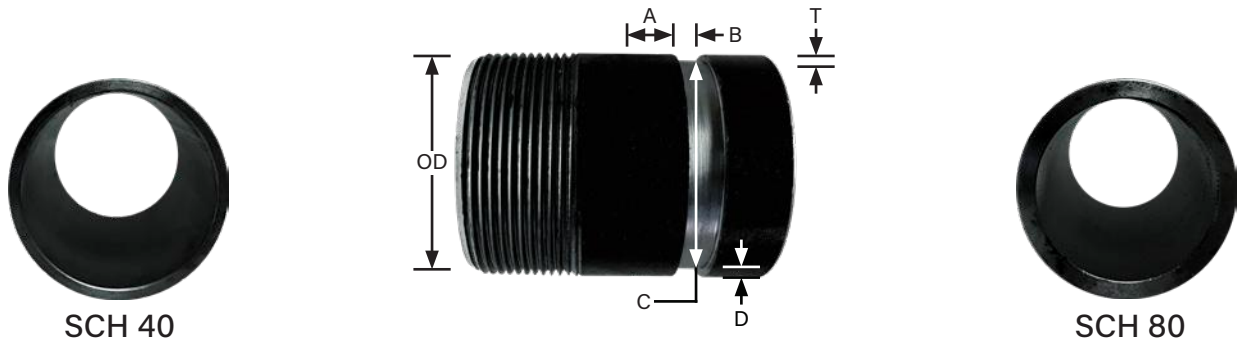

2" DIAMETER

PART #	LIST PRICE	BOX	WTG	LENGTH	WTG	BOX	PART #	LIST PRICE
57162TV	---	50	0.70	x 3	1.03	40	59162TV	---
57164TV	---	30	0.97	x 4	1.40	24	59164TV	---
57168TV	---	20	1.64	x 6	2.41	16	59168TV	---
57170TV	---	20	2.15	x 8	3.20	16	59170TV	---
57172TV	---	10	2.80	x 10	3.65	8	59172TV	---
57174TV	---	10	3.45	x 12	4.01	8	59174TV	---

3" DIAMETER

PART #	LIST PRICE	BOX	WTG	LENGTH	WTG	BOX	PART #	LIST PRICE
57201TV	---	20	1.26	x 3	2.01	16	59201TV	---
57203TV	---	10	1.80	x 4	3.01	8	59203TV	---
57207TV	---	10	3.17	x 6	4.87	8	59207TV	---
57209TV	---	8	4.13	x 8	5.86	6	59209TV	---
57211TV	---	5	5.48	x 10	6.19	4	59211TV	---
57213TV	---	5	6.24	x 12	6.37	4	59213TV	---

4" DIAMETER

PART #	LIST PRICE	BOX	WTG	LENGTH	WTG	BOX	PART #	LIST PRICE
57222TV	---	8	2.40	x 3	4.11	6	59222TV	---
57223TV	---	8	2.52	x 4	4.15	6	59221TV	---
57227TV	---	6	4.30	x 6	6.52	5	59225TV	---
57229TV	---	4	5.63	x 8	7.18	3	59229TV	---
57332TV	---	4	7.90	x 10	11.74	3	59231TV	---
57228TV	---	4	8.25	x 12	14.24	3	59227TV	---

NOMINAL IPS PIPE SIZE	O.D. ACTUAL	GASKET SEAT "A"	GROOVE WIDTH "B"	GROOVE DIAMETER "C"	ACTUAL GROOVE DEPTH "D"
2	2.375	0.625	0.312	2.250	0.062
3	3.500	0.625	0.312	3.344	0.078
4	4.500	0.625	0.375	4.334	0.083

WARNING: This product can expose you to chemicals, including Nickel, which are known to the State of California to cause cancer. For more information, visit www.P65Warnings.ca.gov

FITTINGS & NIPPLES

BLACK SCH 40 AND SCH 80 SEAMLESS GROOVE NIPPLES

FITTINGS AND NIPPLES



SCH 40

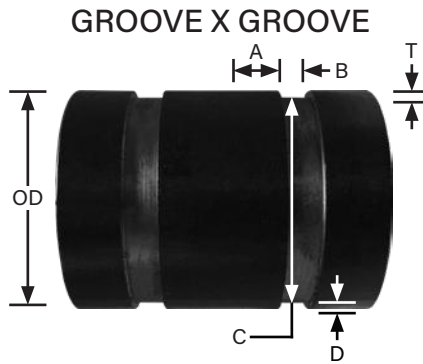

SCH 80

2" DIAMETER

PART #	LIST PRICE	BOX	WTG	LENGTH	WTG	BOX	PART #	LIST PRICE
57162V	---	50	0.70	x 3	1.03	40	59162V	---
57164V	---	30	0.97	x 4	1.40	24	59164V	---
57168V	---	20	1.64	x 6	2.41	16	59168V	---
57170V	---	20	2.15	x 8	3.20	16	59170V	---
57172V	---	10	2.80	x 10	3.65	8	59172V	---
57174V	---	10	3.45	x 12	4.01	8	59174V	---

3" DIAMETER

PART #	LIST PRICE	BOX	WTG	LENGTH	WTG	BOX	PART #	LIST PRICE
57201V	---	20	1.26	x 3	2.01	16	59201V	---
57203V	---	10	1.80	x 4	3.01	8	59203V	---
57207V	---	10	3.17	x 6	4.87	8	59207V	---
57209V	---	8	4.13	x 8	5.86	6	59209V	---
57211V	---	5	5.48	x 10	6.19	4	59211V	---
57213V	---	5	6.24	x 12	6.37	4	59213V	---

4" DIAMETER

PART #	LIST PRICE	BOX	WTG	LENGTH	WTG	BOX	PART #	LIST PRICE
57223V	---	8	2.52	x 4	4.15	6	59221V	---
57227V	---	6	4.35	x 6	6.52	5	59225V	---
57229V	---	4	5.63	x 8	7.18	3	59227V	---
57332V	---	4	7.90	x 10	11.74	3	59229V	---
57228V	---	4	8.25	x 12	14.24	3	59231V	---

SEAMLESS SCH 40 GROOVE X BEVEL NIPPLES



PART #	DIA. X LENGTH	
57162GBS	2 x 3	---
57201GBS	3 x 3	---
57222GBS	4 x 3	---
57400GBS	8 x 3	---
57500GBS	10 x 3	---
57600GBS	12 x 3	---

WARNING: This product can expose you to chemicals, including Nickel, which are known to the State of California to cause cancer. For more information, visit www.P65Warnings.ca.gov



MERCHANT COUPLINGS

FITTINGS AND NIPPLES

MERCHANT COUPLINGS

Product Specifications

Welded steel couplings both galvanized and black in diameters from 1/8" up to 4".

Technical Specifications

Standards: Product complies with ASTM A865 and ANSI B1.20.1 for threading, dimensions and pipe specifications. Federal Spec WW-P-404

Pipe: Complies with ASTM A-53 milltested schedule 40 and 80. Meets ANSI B36.1. All pipe is hydrostatic tested.

Galvanized: Zinc coating applied by hot dipping. Galvanized complying with ASTM-A-123.

MERCHANT COUPLINGS

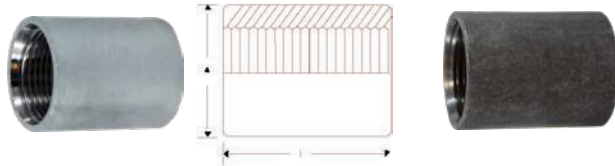

• Straight threads thru 2"

PART # GALV	LIST PRICE	SIZE	PART # BLACK	LIST PRICE
64770	---	1/8"	65770	---
64771	---	1/4"	65771	---
64772	---	3/8"	65772	---
64773	---	1/2"	65773	---
64774	---	3/4"	65774	---
64775	---	1"	65775	---
64776	---	1-1/4"	65776	---
64777	---	1-1/2"	65777	---
64778	---	2"	65778	---
64779	---	2-1/2"	65779	---
64780	---	3"	65780	---
64781	---	4"	65781	---
		5"	65782	---
		6"	65783	---

HALF MERCHANT COUPLINGS



• Straight threads thru 2"

PART # GALV	LIST PRICE	SIZE	PART # BLACK	LIST PRICE
		1/8"	65770H	
		1/4"	65771H	---
		3/8"	65772H	---
64773H	---	1/2"	65773H	---
64774H	---	3/4"	65774H	---
64775H	---	1"	65775H	---
64776H	---	1-1/4"	65776H	---
64777H	---	1-1/2"	65777H	---
64778H	---	2"	65778H	---
		2-1/2"	65779H	---
	---	3"	65780H	---
	---	4"	65781H	---



#304 STAINLESS STEEL MERCHANT COUPLINGS

PART #	SIZE	LIST PRICE
61775	1	---
61776	1-1/4	---
61777	1-1/2	---
61778	2	---

Also available:

Extra Heavy Merchant Couplings

MERCHANT COUPLINGS SPECIFICATIONS

SIZE	OUTSIDE DIAM.	LENGTH	WEIGHT 100 PCS APPROX.	QUANTITY PER BOX	THREADS PER INCH	THREADS
		INCHES	POUNDS			TYPE
1/8"	.59"	.78	3.5	1000	27	Straight
1/4"	.73"	1.18	7.5	500	18	Straight
3/8"	.86"	1.18"	9	600	18	Straight
1/2"	1.063"	1-9/16"	13.0	100	14	Straight
3/4"	1.313"	1-5/8"	28.3	50	14	Straight
1"	1.576"	2"	40.1	30	11-1/2	Straight
1-1/4"	1.900"	2-1/16"	49.5	25	11-1/2	Straight
1-1/2"	2.17"	2-3/64"	71.48	25	11-1/2	Straight
2"	2.750"	2-1/8"	112.0	20	11-1/2	Straight
2-1/2"	3.250"	3-1/8"	231.2	8	8	Taper Tapped
3"	4.000"	3-1/4"	353.8	5	8	Taper Tapped
4"	5.000"	3-1/2"	471.8	4	8	Taper Tapped
6"	7.32	4"	1000.05	4	8	Taper Tapped

WARNING: This product can expose you to chemicals, including Nickel, which are known to the State of California to cause cancer. For more information, visit www.P65Warnings.ca.gov

FITTINGS & NIPPLES

API LINE PIPE

FITTINGS AND NIPPLES

API LINE COUPLINGS

A105 BLACK STEEL TAPER TAPPED COUPLINGS

Product Specifications

These couplings are manufactured in accordance with American Petroleum Institute specifications 5L & 5B.

All couplings are phosphated.

All sizes are taper tapped 3/4" per foot on the diameter.

*CERTIFIED BY THE AMERICAN PETROLEUM INSTITUTE



A105

- Black Steel
- API line API SL

- Each end has a short, unthreaded recess before the threads start.
- Use with sch 80 & sch. 160 nipples & pipe.
- Max. pressure: 3000PSI

API LINE PIPE COUPLINGS

PART #	NPT SIZE	THREADS PER INCH	OUTSIDE DIAMETER	LENGTH	UNIT WEIGHT	LIST PRICE
65770API	1/8"	27	0.563	1-1/16	0.04	---
65771API	1/4"	18	0.719	1-5/8	0.10	---
65772API	3/8"	18	0.875	1-5/8	0.13	---
65773API	1/2"	14	1.063	2-1/8	0.24	---
65774API	3/4"	14	1.313	2-1/8	0.35	---
65775API	1"	11.5	1.576	2-5/8	0.52	---
65776API	1-1/4"	11.5	2.054	2-3/4	1.00	---
65777API	1-1/2"	11.5	2.200	2-3/4	0.88	---
65778API	2"	11.5	2.875	2-7/8	1.83	---
65780API	3"	8	4.000	4-1/4	4.09	---
65781API	4"	8	5.200	4-1/2	7.59	---
65783API	6"	8	7.390	4-5/8	12.92	---
65784API	8"	8	9.625	5-3/4	23.18	---

WARNING: This product can expose you to chemicals, including Nickel, which are known to the State of California to cause cancer. For more information, visit www.P65Warnings.ca.gov

MALLEABLE FITTINGS

FITTINGS AND NIPPLES

MALLEABLE FITTINGS



- SATURATED STEAM PRESSURE 150 PSI @ 350°F
- MAX PRESSURE 300 PSI @ 150°F
- TEMP RANGE -20°F TO 350°F

ISO 9002 - CERTIFICATE OF QUALITY - UL/FM LISTED

Our quality fittings are made with care and attention to detail. With better molds we can reduce parting lines and rough edges resulting in better fluid flow. By using a low temperature galvanizing process the coating is more durable which means a longer lasting fitting. All Fittings are 100% Pressure Tested to 300# Class. (Every fitting is subjected to an underwater fitness test to ensure the highest quality)

SPECIFICATIONS

- MATERIAL: ASTM A 197 - Cuppla Malleable Iron, ASTM A 153 - Hot dipped galvanizing • Coating ASTM A164 LS
- DIMENSIONS: ANSI B 16.3 - Malleable Iron threaded fittings, ANSI B 16.14 - Ferrous Pipe Plugs, Bushings etc..., ANSI B 16.39 - Malleable Iron threaded pipe unions.
- THREADS: ANSI B 2.1 or BS 21 ASME B1.20.1 • RoHS Compliant • Tapered Threads
- Pressure - Saturated steam 150 PSI @350°F: Max pressure 300 PSI - 150°F
- Temperature range -20 - 350°F

MALLEABLE IRON - ANSI B 16.3				
F°	CLASS 150 PSIG	SIZES 1/4-1 300#	SIZES 1 1/4-2 300#	SIZES 2 1/4-3 300#
-200-150	300	2000	1500	1000
200	265	1785	1350	910
250	225	1575	1200	825
300	185	1360	1050	735
366*	150	1150	900	650

*Permissible for service temperature up to 366°F, reflecting the temperature of saturated steam at 150 psig.

STEEL FITTINGS



- 1010 Carbon Steel, 3/4 taper threads (see hydraulic section for 7/8 taper threads.)
- Finish or coating • Black Dipped in rust resistant • Galvanized, Zinc Plated (Inside and Out)

300LB MALLEABLE FITTINGS



- MAX. PRESSURE: 300 PSI WOG @ 72°F; 150 PSI WOG SATURATED STEAM
- MEET ANSI/ ASME B1.20.1 STANDARDS
 - BLACK MEET ASTM 197 STANDARDS

BULL PLUGS AND SWAGES



FLANGES



WARNING: This product can expose you to chemicals, including Nickel, which are known to the State of California to cause cancer. For more information, visit www.P65Warnings.ca.gov

FITTINGS & NIPPLES

BLACK AND GALVANIZED IRON #150

FITTINGS AND NIPPLES

ELBOWS 90°

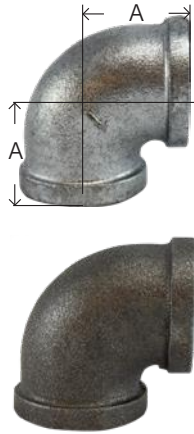

PART # GALVANIZED	LIST PRICE	SIZE	A	BOX/ CASE	APPROX. WT. LBS.	PART # BLACK	LIST PRICE
64100	---	1/8"	0.69	50/600	0.07	65100	---
64101	---	1/4"	0.81	35/420	0.10	65101	---
64102	---	3/8"	0.95	90/360	0.16	65102	---
64103	---	1/2"	1.12	50/200	0.23	65103	---
64104	---	3/4"	1.31	35/105	0.35	65104	---
64105	---	1"	1.50	20/60	0.57	65105	---
64106	---	1-1/4"	1.75	20/40	0.86	65106	---
64107	---	1-1/2"	1.94	15/30	1.31	65107	---
64108	---	2"	2.25	8/16	1.79	65108	---
64109	---	2-1/2"	2.70	6/12	3.35	65109	---
64110	---	3"	3.08	4/8	5	65110	---
64112	---	4"	3.79	1/2	9.02	65112	---
64114	---	6"	5.13	1/1	23.68	65114	---

REDUCING ELBOWS 90°

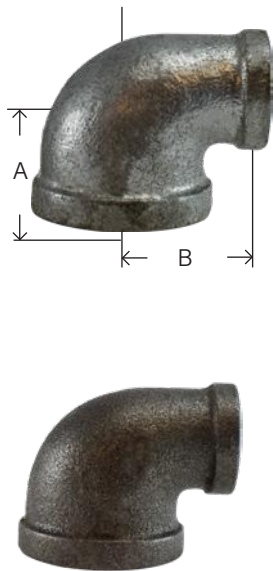

PART # GALVANIZED	LIST PRICE	SIZE	A	B	BOX/ CASE	AP-PROX. WT. LBS.	PART # BLACK	LIST PRICE
64123	---	3/8" x 1/4"	0.88	0.90	90/360	0.16	65122	---
64124	---	1/2" x 1/4"	0.97	0.98	60/240	0.21	65123	---
64126	---	1/2" x 3/8"	1.04	1.03	60/240	0.24	65124	---
64127	---	3/4" x 3/8"	1.12	1.13	40/160	0.31	65126	---
64127	---	3/4" x 1/2"	1.20	1.22	40/160	0.44	65127	---
64130	---	1" x 1/2"	1.26	1.40	25/100	0.52	65130	---
64131	---	1" x 3/4"	1.37	1.45	50/100	0.58	65131	---
64133	---	1-1/4" x 3/4"	1.45	1.62	15/120	0.79	65133	---
64134	---	1-1/4" x 1"	1.58	1.67	10/40	0.80	65134	---
64137	---	1-1/2" x 3/4"	1.52	1.75	10/40	0.88	65136	---
64137	---	1-1/2" x 1"	1.65	1.80	10/40	1.07	65137	---
64138	---	1-1/2" x 1-1/4"	1.82	1.88	15/30	1.12	65138	---
64140	---	2" x 3/4"					65139	---
64140	---	2" x 1"	1.73	2.02	14/28	1.41	65140	---
64141	---	2" x 1-1/4"	1.90	2.10	10/20	1.53	65141	---
64142	---	2" x 1-1/2"	2.02	2.16	10/20	1.65	65142	---
64145	---	2-1/2" x 1-1/2"	2.16	2.51	6/12	2.97	65145	---
64146	---	2-1/2" x 2"	2.39	2.60	6/12	3.18	65146	---
65150	---	3 x 2					65150	---
65151	---	3 x 2-1/2					65151	---

90° STREET ELBOWS

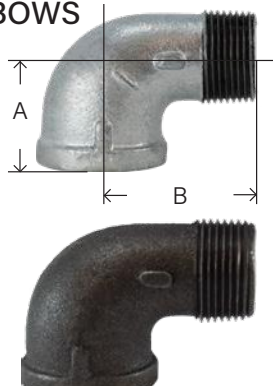

PART # GALVANIZED	LIST PRICE	SIZE	A	B	BOX/ CASE	APPROX. WT. LBS.	PART # BLACK	LIST PRICE
64160	---	1/8"	0.69	1.00	60/720	.06	65160	---
64161	---	1/4"	0.80	1.17	35/420	.10	65161	---
64162	---	3/8"	0.95	1.48	40/240	.15	65162	---
64163	---	1/2"	1.10	1.59	60/180	.22	65163	---
64164	---	3/4"	1.28	1.85	35/105	.39	65164	---
64165	---	1"	1.47	2.10	35/105	.60	65165	---
64166	---	1-1/4"	1.75	2.57	25/50	.95	65166	---
64167	---	1-1/2"	1.90	2.63	9/27	1.37	65167	---
64168	---	2"	2.21	3.19	8/16	2.25	65168	---
64169	---	2-1/2"	2.65	3.78	5/10	3.32	65169	---
64170	---	3"	3.02	4.42	4/8	5.27	65170	---
64171	---	4"	3.72	5.57	2/4	8.94	65171	---

WARNING: This product can expose you to chemicals, including Nickel, which are known to the State of California to cause cancer. For more information, visit www.P65Warnings.ca.gov

BLACK AND GALVANIZED IRON #150

FITTINGS AND NIPPLES

ELBOWS 45°

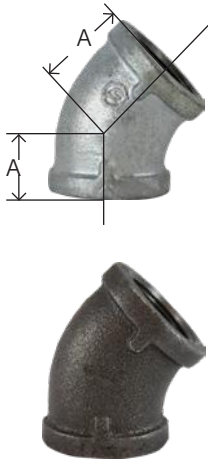

PART # GALVANIZED	LIST PRICE	SIZE	A	BOX/ CASE	APPROX. WT. LBS.	PART # BLACK	LIST PRICE
64180	---	1/8"	0.63	50/600	.07	65180	---
64181	---	1/4"	0.73	30/360	.10	65181	---
64182	---	3/8"	0.80	75/300	.14	65182	---
64183	---	1/2"	0.88	50/200	.21	65183	---
64184	---	3/4"	0.98	40/120	.33	65184	---
64185	---	1"	1.12	20/60	.50	65185	---
64186	---	1-1/4"	1.29	20/40	.74	65186	---
64187	---	1-1/2"	1.43	10/30	1.01	65187	---
64188	---	2"	1.68	12/24	1.53	65188	---
64189	---	2-1/2"	1.95	9/18	2.78	65189	---
64190	---	3"	2.17	1/10	4.49	65190	---
64191	---	4"	2.61	2/4	7.44	65191	---
64192	---	6"	3.46	1/1	18.63	65192	---

45° STREET ELBOWS

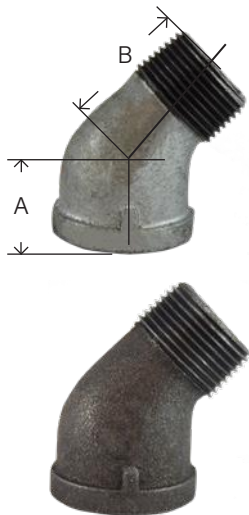

PART # GALVANIZED	LIST PRICE	SIZE	A	B	BOX/ CASE	APPROX. WT. LBS.	PART # BLACK	LIST PRICE
64200	---	1/8"	0.63	0.83	70/840	.05	65200	---
64201	---	1/4"	0.73	0.94	40/480	.09	65201	---
64202	---	3/8"	0.80	1.03	100/400	.14	65202	---
64203	---	1/2"	0.86	1.30	75/225	.19	65203	---
64204	---	3/4"	0.96	1.48	40/120	.28	65204	---
64205	---	1"	1.10	1.69	25/75	.48	65205	---
64206	---	1-1/4"	1.26	1.87	10/40	.71	65206	---
64207	---	1-1/2"	1.40	2.05	10/30	1.02	65207	---
64208	---	2"	1.65	2.38	12/24	1.68	65208	---
64209	---	2-1/2"	1.95	2.72	6/12	2.69	65209	---
64210	---	3"	2.17	3.16	3/6	4.61	65210	---
	---	4"	2.61	3.90	2/4	7.74	65211	---

CROSSES

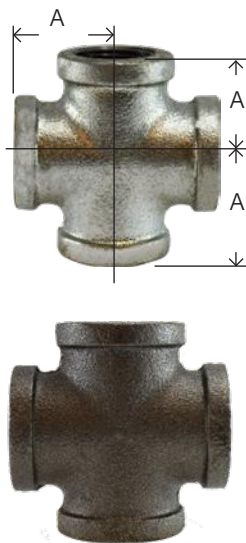

PART # GALVANIZED	LIST PRICE	SIZE	A	BOX/ CASE	APPROX. WT. LBS.	PART # BLACK	LIST PRICE
	---	1/8"	0.65	50/600	.14	65390	---
64391	---	1/4"	0.80	60/240	.17	65391	---
64392	---	3/8"	0.95	50/150	.26	65392	---
64393	---	1/2"	1.12	30/90	.42	65393	---
64394	---	3/4"	1.31	20/60	.64	65394	---
64395	---	1"	1.50	15/30	.98	65395	---
64396	---	1-1/4"	1.75	10/20	1.45	65396	---
64397	---	1-1/2"	1.94	8/16	1.90	65397	---
64398	---	2"	2.25	5/10	2.96	65398	---
	---	3"	3.06	2/4	7.71	65400	---
	---	4"		1/1	14.77	65401	---

WARNING: This product can expose you to chemicals, including Nickel, which are known to the State of California to cause cancer. For more information, visit www.P65Warnings.ca.gov

FITTINGS & NIPPLES

BLACK AND GALVANIZED IRON #150

FITTINGS AND NIPPLES

TEES

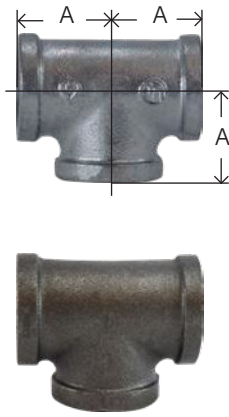

PART # GALVANIZED	LIST PRICE	SIZE	A	BOX/CASE	APPROX. WT. LBS.	PART # BLACK	LIST PRICE
64250	---	1/8"	0.69	120/480	.11	65250	---
64251	---	1/4"	0.81	75/300	.15	65251	---
64252	---	3/8"	0.95	45/180	.22	65252	---
64253	---	1/2"	1.12	40/120	.36	65253	---
64254	---	3/4"	1.31	35/70	.48	65254	---
64255	---	1"	1.50	20/40	.83	65255	---
64256	---	1-1/4"	1.75	14/28	1.29	65256	---
64257	---	1-1/2"	1.94	12/24	1.66	65257	---
64258	---	2"	2.26	8/16	2.50	65258	---
64259	---	2-1/2"	2.70	4/8	4.45	65259	---
64260	---	3"	3.08	1/6	6.72	65260	---
64261	---	4"	3.79	1/2	11.31	65261	---
64262	---	6"	5.13	1/1	30.75	65262	---

REDUCING TEES

(Same Size On Run, Reducing On Branch)

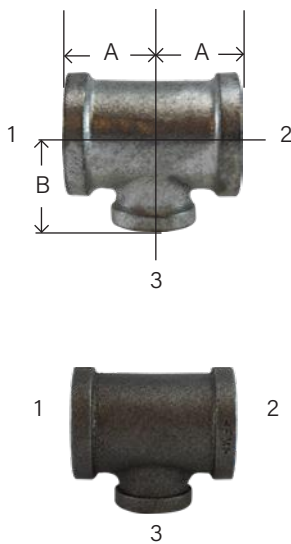

PART # GALVANIZED	LIST PRICE	SIZE (1&2) X 3	A	B	BOX/CASE	APPROX. WT. LBS.	PART # BLACK	LIST PRICE
	---	3/8" x 1/4"	0.81	0.90	25/300	.18	65273	---
	---	1/2" x 1/4"	0.97	0.98	40/160	.24	65276	---
64279	---	1/2" x 3/8"	1.04	1.03	40/160	.35	65279	---
	---	3/4" x 1/4"	1.05	1.08	25/100	.43	65282	---
64286	---	3/4" x 1/2"	1.20	1.18	20/80	.49	65286	---
	---	1" x 1/4"	1.11	1.22	20/80	.51	65268	---
64269	---	1" x 3/8"	1.18	1.27	15/60	.55	65269	---
64291	---	1" x 1/2"	1.26	1.40	15/60	.63	65291	---
64298	---	1" x 3/4"	1.37	1.45	12/48	.71	65298	---
64301	---	1-1/4" x 1/2"	1.34	1.45	20/40	.91	65301	---
64303	---	1-1/4" x 3/4"	1.45	1.62	20/40	.99	65303	---
64306	---	1-1/4" x 1"	1.58	1.66	20/40	1.07	65306	---
64721	---	1-1/2" x 1/2"				1.12	65721	---
64316	---	1-1/2" x 3/4"	1.41	1.75	15/30	1.23	65316	---
64318	---	1-1/2" x 1"	1.65	1.88	10/30	1.33	65318	---
	---	1-1/2" x 1-1/4"	1.65	1.88	12/24	1.52	65322	---
64327	---	2" x 1/2"	1.49	1.88	10/20	1.64	65327	---
64328	---	2" x 3/4"	1.60	1.97	10/20	1.71	65328	---
64330	---	2" x 1"	1.73	2.02	10/20	1.88	65330	---
	---	2" x 1-1/4"	1.86	2.06	8/16	2.03	65334	---
64336	---	2" x 1-1/2"	1.98	2.12	8/16	2.22	65336	---
	---	2-1/2" x 1"				2.85	65342	---
	---	2-1/2" x 1-1/2"	2.16	2.51	5/10	2.97	65343	---
	---	3" x 1-1/2"				5.19	65359	---
64351	---	3" x 2"	2.52	2.89	3/6	5.35	65351	---

BULLHEAD TEES

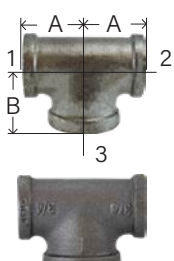

PART # GALVANIZED	LIST PRICE	SIZE (1&2) X 3	A	B	BOX/CASE	APPROX. WT. LBS.	PART # BLACK	LIST PRICE
64280	---	1/2" x 3/4"	1.22	1.20	30/120	.4	65280	---
64289	---	3/4" x 1"	1.45	1.37	20/120	.60	65289	---
64299	---	1" x 1-1/4"	1.67	1.58	15/30	.96	65299	---
64300	---	1" x 1-1/2"	1.80	1.65	9/36	1.11	65300	---
64317	---	1-1/4" x 1-1/2"	1.88	1.82	12/24	1.07	65317	---
64319	---	1-1/2" x 2"	2.12	1.98	8/32	2.10	65319	---
	---	2" x 1 1/4" x 2"					65335	---

WARNING: This product can expose you to chemicals, including Nickel, which are known to the State of California to cause cancer. For more information, visit www.P65Warnings.ca.gov

BLACK AND GALVANIZED IRON #150

FITTINGS AND NIPPLES

REDUCING TEES

REDUCING ON RUN

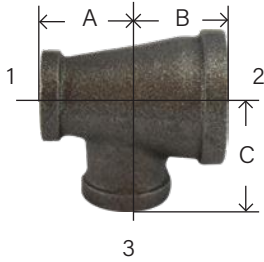

PART #	SIZE 1 X 2 X 3	A	B	C	BOX/CASE	APPROX. WT. LBS.	LIST PRICE	PART # BLACK
64287	3/4" x 1/2" x 1/2"	1.18	1.18	1.20	25/100	0.39	---	65287
	3/4" x 1/2" x 3/4"	1.28	1.20	1.28	20/80	0.49	---	65288
	1" x 1/2" x 1/2"	1.31	1.22	1.31	20/80	0.51	---	65292
	1" x 1/2" x 3/4"	1.22	1.37	1.45	20/80	0.53	---	65293
	1" x 1/2" x 1"	1.40	1.50	1.50	15/60	0.54	---	65294
	1" x 3/4" x 1/2"	1.20	1.26	1.40	20/80	0.58	---	65295
64296	1" x 3/4" x 3/4"	1.34	1.28	1.42	15/60	0.63	---	65296
64297	1" x 3/4" x 1"	1.45	1.50	1.50	15/60	0.62	---	65297
	1-1/4" x 1/2" x 1"							65311
	1-1/4" x 1/2" x 1 1/4"							65314
	1-1/4" x 3/4" x 3/4"	1.31	1.45	1.64	10/40	0.66	---	65347
	1-1/4" x 3/4" x 1"							65348
	1-1/4" x 3/4" x 1-1/4"	1.62	1.75	1.75	10/40	1.14	---	65305
64309	1-1/4" x 1" x 1"	1.55	1.47	1.63	20/40	1.00	---	65309
	1-1/4" x 1" x 1/2"	1.26	1.34	1.53	20/40	1.10	---	65349
	1-1/4" x 1" x 3/4"							65350
	1-1/4" x 1" x 1-1/4"	1.30	1.36	1.44	15/30	1.21	---	65310
	1-1/2" x 3/4" x 1-1/2"							65281
64372	1-1/2" x 1" x 1"	1.50	1.65	1.78	15/30	1.28	---	65372
	1-1/2" x 1" x 1-1/2"							65323
	1-1/2" x 1-1/4" x 3/4"	1.43	1.52	1.25	15/30	1.30	---	65375
	1-1/2" x 1 1/4" x 1"							65325
	1-1/2" x 1-1/4" x 1-1/4"	1.75	1.82	1.88	15/30	1.35	---	65377
	2" x 3/4" x 2"							65267
	2" x 1" x 2"							65332
	2" x 1-1/4" x 1 1/4"							65302
	2" x 1-1/4" x 2"							65335
	2" x 1-1/2" x 1-1/4"	1.82	1.90	2.10	10/30	1.21	---	65312
	2" x 1-1/2" x 1-1/2"	1.94	2.02	2.16	10/30	1.79	---	65313
	2 x 1-1/2 x 2							65339

MALLEABLE SERVICE TEE

(STREET TEE)

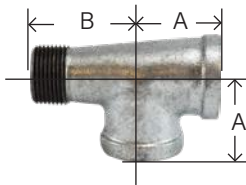

PART # GALVANIZED	LIST PRICE	SIZE	A	B	BOX/ CASE	APPROX. WT. LBS.	PART # BLACK	LIST PRICE
64364	---	3/4"	1.31	1.89	25/75	0.49	65364	---

SIDE OUTLET TEES

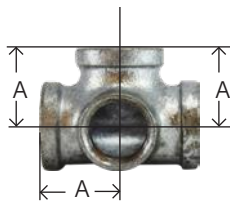

PART # GALVANIZED	LIST PRICE	SIZE	A	BOX/ CASE	APPROX. WT. LBS.	PART # BLACK	LIST PRICE
64383	---	1/2"	1.12	25/100	.39	65383	---
64385	---	1"	1.50	20/40	.88	65385	---
		1-1/2"	1.97	1/1	1.56	65387	---
		2"	2.29	1/1	1.81	65388	---

WARNING: This product can expose you to chemicals, including Nickel, which are known to the State of California to cause cancer. For more information, visit www.P65Warnings.ca.gov

FITTINGS & NIPPLES

BLACK AND GALVANIZED IRON #150

FITTINGS AND NIPPLES

COUPLINGS



PART # GALVANIZED	LIST PRICE	SIZE	A	BOX/ CASE	APPROX. WT. LBS.	PART # BLACK	LIST PRICE
64410	---	1/8"	0.96	70/840	.07	65410	---
64411	---	1/4"	1.06	40/480	.09	65411	---
64412	---	3/8"	1.16	40/480	.13	65412	---
64413	---	1/2"	1.34	60/240	.19	65413	---
64414	---	3/4"	1.52	50/150	.28	65414	---
64415	---	1"	1.67	25/100	.45	65415	---
64416	---	1-1/4"	1.93	16/64	.66	65416	---
64417	---	1-1/2"	2.15	18/36	.84	65417	---
64418	---	2"	2.54	12/24	1.39	65418	---
64419	---	2-1/2"	2.88	8/16	2.42	65419	---
64420	---	3"	3.18	1/12	3.49	65420	---
64421	---	4"	3.69	3/6	5.81	65421	---
64422	---	6"	4.23	1/2	28.62	65422	---

REDUCING COUPLINGS



PART # GALVANIZED	LIST PRICE	SIZE	A	BOX/ CASE	APPROX. WT. LBS.	PART # BLACK	LIST PRICE
64430	---	1/4" x 1/8"	1.00	50/600	.07	65430	---
64431	---	3/8" x 1/8"	1.13	35/420	.09	65431	---
64432	---	3/8" x 1/4"	1.13	30/360	.11	65432	---
64433	---	1/2" x 1/8"	1.25	75/300	.13	65433	---
64434	---	1/2" x 1/4"	1.25	75/300	.11	65434	---
64435	---	1/2" x 3/8"	1.25	60/240	.15	65435	---
	---	3/4" x 1/8"	1.44	60/240	.18	65439	---
64436	---	3/4" x 1/4"	1.44	45/18	.19	65436	---
64437	---	3/4" x 3/8"	1.44	45/18	.21	65437	---
64438	---	3/4" x 1/2"	1.44	60/180	.25	65438	---
64459	---	1" x 1/4"	1.69	45/135	.34	65459	---
64440	---	1" x 3/8"	1.69	30/120	.35	65440	---
64441	---	1" x 1/2"	1.69	30/120	.36	65441	---
64442	---	1" x 3/4"	1.69	25/100	.39	65442	---
	---	1-1/4" x 3/8"	2.06	25/75	.55	65460	---
	---	1-1/4" x 1/2"	2.06	25/75	.53	65444	---
64445	---	1-1/4" x 3/4"	2.06	25/75	.57	65445	---
64446	---	1-1/4" x 1"	2.06	15/60	.61	65446	---
	---	1-1/2" x 3/8"	2.31	20/60	.71	65443	---
64447	---	1-1/2" x 1/2"	2.31	20/60	.69	65447	---
64448	---	1-1/2" x 3/4"	2.31	15/60	.71	65448	---
64449	---	1-1/2" x 1"	2.31	25/50	.78	65449	---
64450	---	1-1/2" x 1-1/4"	2.31	12/48	.87	65450	---
64458	---	2" x 1/2"	2.81	12/36	1.14	65458	---
64451	---	2" x 3/4"	2.81	12/36	1.14	65451	---
64452	---	2" x 1"	2.81	12/36	1.21	65452	---
64453	---	2" x 1-1/4"	2.81	9/27	1.19	65453	---
64454	---	2" x 1-1/2"	2.81	9/27	1.38	65454	---
		2 1/2" x 1"				65455	
		2 1/2" x 1 1/4"				65429	
64461	---	2-1/2" x 1-1/2"	3.25	20/40	2.07	65461	---
64462	---	2-1/2" x 2"	3.25	7/14	2.23	65462	---
64466		3" x 1"				65466	
64486	---	3" x 1-1/2"	3.69	6/12	3.23	65486	---
64456	---	3" x 2"	3.69	6/12	3.30	65456	---
64463	---	3" x 2-1/2"	3.69	5/10	3.55	65463	---
		4" x 1 1/2"				65468	
64464	---	4" x 2"	4.38	3/6	5.55	65464	---
64465	---	4" x 2-1/2"	4.38	3/6	5.90	65465	---
64457	---	4" x 3"	4.38	3/6	6.05	65457	---
		6" x 4"	4.24	1/2	10.86	65491	----

WARNING: This product can expose you to chemicals, including Nickel, which are known to the State of California to cause cancer. For more information, visit www.P65Warnings.ca.gov



BLACK AND GALVANIZED IRON #150

FITTINGS AND NIPPLES

HEX BUSHING



Hex



* INSIDE HEX

Note: Add Dt To The Part# For A Double-

PART # GALVANIZED	LIST PRICE	SIZE M X F	A	HEX	BOX/ CASE	APPROX. WT. LBS.	PART # BLACK	LIST PRICE
64500	---	*1/4" x 1/8"	0.79	0.67	1/25	.03	65500	---
	---	*3/8" x 1/8"	0.79	0.75	1/25	.06	65501	---
64502	---	*3/8" x 1/4"	0.79	0.75	1/25	.05	65502	---
	---	1/2" x 1/8"	0.84	1.03	150/600	.09	65503	---
64504	---	1/2" x 1/4"				.08	65504	---
64505	---	1/2" x 3/8"	0.75	1.03	150/600	.07	65505	---
64506	---	3/4" x 1/8"	0.85	1.15	75/300	.14	65506	---
64507	---	3/4" x 1/4"	0.85	1.15	75/300	.13	65507	---
64508	---	3/4" x 3/8"	0.85	1.15	75/300	.12	65508	---
64509	---	3/4" x 1/2"	0.93	1.15	75/300	.10	65509	---
		1" x 1/8"					65557	
64510*	---	1" x 1/4"	1.13	1.12	50/200	.20	65510*	---
64511*	---	1" x 3/8"	1.13	1.12	50/200	.18	65511*	---
64512	---	1" x 1/2"	1.10	1.42	50/200	.21	65512	---
64513	---	1" x 3/4"	1.10	1.42	50/200	.17	65513	---
	---	1-1/4" x 1/4"	1.24	1.12	30/120	.29	65514*	---
	---	1-1/4" x 3/8"	1.24	1.12	30/120	.29	65515*	---
64516*	---	1-1/4" x 1/2"	1.24	1.24	30/120	.31	65516*	---
64517	---	1-1/4" x 3/4"	1.08	1.76	30/120	.35	65517	---
64518	---	1-1/4" x 1"	1.08	1.76	30/120	.29	65518	---
64519*	---	1-1/2" x 1/4"	1.30	1.12	25/75	.40	65519*	---
64520*	---	1-1/2" x 3/8"	1.30	1.12	25/75	.38	65520*	---
64521*	---	1-1/2" x 1/2"	1.30	1.34	25/75	.38	65521*	---
64522*	---	1-1/2" x 3/4"	1.30	1.44	25/75	.40	65522*	---
64523	---	1-1/2" x 1"	1.23	2.00	25/75	.45	65523	---
64524	---	1-1/2" x 1-1/4"	1.23	2.00	25/75	.34	65524	---
64526	---	2" x 1/4"	1.29	1.12	20/60	.57	65526	---
64525*	---	2" x 3/8"	1.28	1.12	20/60	.57	65525*	---
64527*	---	2" x 1/2"	1.39	1.34	20/60	.57	65527*	---
64528*	---	2" x 3/4"	1.39	1.63	20/60	.63	65528*	---
64529*	---	2" x 1"	1.39	1.77	20/60	.66	65529*	---
64530	---	2" x 1-1/4"	1.50	2.48	20/60	.74	65530	---
64531	---	2" x 1-1/2"	1.50	2.48	20/60	.61	65531	---
64546*	---	2-1/2" x 1/2"	1.51	1.34	15/30	.97	65546*	---
64547*	---	2-1/2" x 3/4"	1.51	1.63	15/30	.91	65547*	---
64532*	---	2-1/2" x 1"	1.51	1.95	15/30	.97	65532*	---
64533*	---	2-1/2" x 1-1/4"	1.51	2.39	15/30	1.03	65533*	---
64534	---	2-1/2" x 1-1/2"	1.51	2.98	15/30	1.16	65534	---
64535	---	2-1/2" x 2"	1.54	2.98	15/30	1.01	65535	---
64550	---	3" x 1"	1.61	1.95	12/24	1.41	65550	---
64549*	---	3" x 1-1/4"	1.61	2.39	12/24	1.42	65549*	---
64537*	---	3" x 1-1/2"	1.61	2.68	12/24	1.51	65537*	---
64538	---	3" x 2"	1.61	3.86	12/24	1.71	65538	---
64539	---	3" x 2-1/2"	1.61	3.86	12/24	1.68	65539	---
		3-1/2" x 3"	1.86	4.20	5/10	2.17	65555	---
64553*	---	4" x 1"	2.00	4.75	5/10	3.79	65553*	---
	---	4" x 1-1/4"	1.82	2.39	5/10	2.39	65552	---
64540	---	4" x 1-1/2"	1.82	2.68	5/10	2.39	65540	---
64541*	---	4" x 2"	1.82	3.31	5/10	2.52	65541*	---
64542*	---	4" x 2-1/2"	2.06	3.87	5/10	2.87	65542*	---
64543	---	4" x 3"	2.17	4.96	5/10	2.95	65543	---
		5" x 4"	2.16	5.34	2/4	6.80	65544	---
		6" x 2"					65558	
64549		6" x 3"					65559	
64545*	---	6" x 4"	2.33	5.79	2/4	7.11	65545*	---

WARNING: This product can expose you to chemicals, including Nickel, which are known to the State of California to cause cancer. For more information, visit www.P65Warnings.ca.gov

FITTINGS & NIPPLES

BLACK AND GALVANIZED IRON #150

FITTINGS AND NIPPLES

UNIONS

• Brass Seat



PART # GALVANIZED	LIST PRICE	SIZE	A	BOX/ CASE	APPROX. WT. LBS.	PART # BLACK	LIST PRICE
64600	---	1/8"	1.26	60/240	.17	65600	---
64601	---	1/4"	1.44	20/240	.25	65601	---
64602	---	3/8"	1.61	40/160	.37	65602	---
64603	---	1/2"	1.72	50/100	.52	65603	---
64604	---	3/4"	1.94	35/70	.78	65604	---
64605	---	1"	2.06	20/40	1.18	65605	---
64606	---	1-1/4"	2.26	15/30	1.64	65606	---
64607	---	1-1/2"	2.41	10/20	2.08	65607	---
64608	---	2"	2.75	6/12	3.24	65608	---
64609	---	2-1/2"	3.22	4/8	5.31	65609	---
64610	---	3"	3.50	4/8	6.94	65610	---
64611	---	4"	3.85	2/4	12.02	65611	---

SQUARE HEAD PLUGS

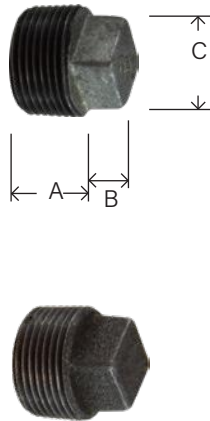

PART # GALVANIZED	LIST PRICE	SIZE	A	B	C	BOX/ CASE	APPROX. WT. LBS.	PART # BLACK	LIST PRICE
		*1/8"	0.41	0.23	0.30	1/25	.02	65650	---
64651	---	*1/4"	0.48	0.28	0.38	1/25	.03	65651	---
64652	---	*3/8"	0.53	0.31	0.43	1/25	.04	65652	---
64653	---	1/2"	0.58	0.38	0.56	50/600	.08	65653	---
64654	---	3/4"	0.65	0.44	0.63	30/360	.13	65654	---
64655	---	1"	0.75	0.50	0.82	20/240	.22	65655	---
64656	---	1-1/4"	0.82	0.56	0.94	40/120	.33	65656	---
64657	---	1-1/2"	0.85	0.62	1.13	30/90	.41	65657	---
64658	---	2"	0.91	0.68	1.31	20/60	.68	65658	---
64659	---	2-1/2"	1.26	0.74	1.50	16/64	.89	65659	---
64660	---	3"	1.16	0.80	1.69	16/32	1.68	65660	---
64661	---	4"	1.22	1.00	2.28	6/12	3.02	65661	---
64662	---	6"	1.85	1.13	5.97	5/10	11.41	65662	---
		8"				1/1		65664	---

CAPS



PART # GALVANIZED	LIST PRICE	SIZE	A	BOX/ CASE	APPROX. WT. LBS.	PART # BLACK	LIST PRICE
64470	---	1/8"	0.55	1/25	.03	65470	---
64471	---	1/4"	0.62	80/960	.07	65471	---
64472	---	3/8"	0.74	60/720	.08	65472	---
64473	---	1/2"	0.87	75/300	.13	65473	---
64474	---	3/4"	0.97	40/160	.18	65474	---
64475	---	1"	1.16	25/100	.30	65475	---
64476	---	1-1/4"	1.28	20/80	.47	65476	---
64477	---	1-1/2"	1.33	18/54	.66	65477	---
64478	---	2"	1.45	12/36	.99	65478	---
64479	---	2-1/2"	1.70	20/40	1.58	65479	---
64480	---	3"	1.80	12/24	2.51	65480	---
64481	---	4"	2.08	6/12	4.09	65481	---
64482	---	6"	2.55	2/4	5.18	65482	---

* Use steel fittings for smaller sizes. See Steel Fittings for Galvanized and Black Steel Fittings.

WARNING: This product can expose you to chemicals, including Nickel, which are known to the State of California to cause cancer. For more information, visit www.P65Warnings.ca.gov

BLACK AND GALVANIZED IRON #150

FITTINGS AND NIPPLES

LATERAL YS

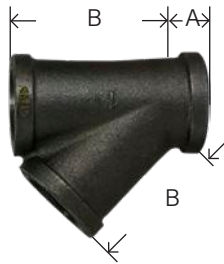

PART #	SIZE	A	B	CASE	WEIGHT	LIST PRICE	PART #
64963	1/2	2.32	1.71	120	.35	---	65963
64964	3/4	2.77	2.05	60	.58	---	65964
	1	3.28	2.42	40	.97	---	65965
	1-1/4	3.94	2.92	24	1.44	---	65966
	1-1/2	4.38	3.28	16	1.93	---	65967
64968	2	5.41	3.98	8	3.12	---	65968
	3	7.26	5.55	2	8.36	---	65970
	4	8.98	6.97	2	14.88	---	65971

LOCKNUTS *STRAIGHT THREAD

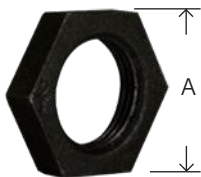

PART # GALV	LIST PRICE	SIZE	A HEX	THICKNESS	BOX/ CASE	WEIGHT	PART # BLACK	LIST PRICE
64703	---	1/2		0.31	150/600	0.08		---
64704	---	3/4		0.34	90/360	0.13	65704	---
64705	---	1		0.38	60/240	0.19		---
64706	---	1-1/4		0.42	45/180	0.27	65706	---
64707	---	1-1/2		0.47	45/135	0.47		---
64708	---	2		0.53	25/75	0.56		---

RIGHT & LEFT COUPLINGS

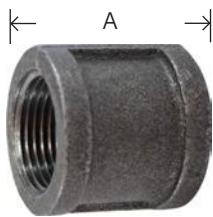

PART # GALV	LIST PRICE	SIZE	A	CASE	WEIGHT	PART # BLACK	LIST PRICE
		3/4	1.52	150	0.28	65574	---
		1	1.67	100	0.45	65575	---
		1-1/4	1.93	64	0.66	65576	---

SIDE OUTLET ELBOW

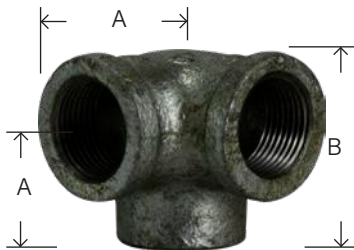

PART # GALV	LIST PRICE	SIZE	A	B	CASE	PART # BLACK	LIST PRICE
64583	---	1/2	1.10		135	65583	---
64584	---	3/4	1.30		80	65584	---
64585	---	1	1.50		40		

WARNING: This product can expose you to chemicals, including Nickel, which are known to the State of California to cause cancer. For more information, visit www.P65Warnings.ca.gov

FITTINGS & NIPPLES

BLACK AND GALVANIZED IRON #150

FITTINGS AND NIPPLES

FLOOR FLANGES

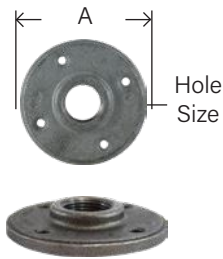

PART # GALVANIZED	LIST PRICE	SIZE	A	THICK-NESS	HOLE SIZE	BOX/ CASE	APPROX. WT. LBS.	PART # BLACK	LIST PRICE
		3/8"						65690	
64692	---	1/2"	3.50	0.50	0.25	25/100	.63	65692	---
64693	---	3/4"	3.50	0.63	0.25	15/45	.73	65693	---
64694	---	1"	4.00	0.69	0.25	15/45	1.02	65694	---
64695	---	1-1/4"	4.00	0.75	0.25	15/30	1.00	65695	---
64696	---	1-1/2"	4.50	0.87	0.31	8/24	1.37	65696	---
64697		2"						65697	

MUSHROOM VENT CAP



PART #	SIZE	LIST PRICE
21174	3/4"	---
21175	1"	---
21176	1-1/2"	---
21177	1-1/2"	---
21178	2"	---
21179	3"	---
21180	4"	---

Cast Iron Galvanized Threaded Cap. 30 Mesh screen. Protects against driving rain, snow, sleet and insects.

DOUBLE TAPPED BUSHINGS



PART #	SIZE	
65518DT	1-1/4" x 1"	
65522DT	1-1/2" x 3/4"	
65523DT	1-1/2" x 1"	
65527DT	2" x 1/2"	
65528DT	2" x 3/4"	
65529DT	2" x 1"	
65530DT	2" x 1 1/4"	
65531DT	2" x 1-1/2"	
65541DT	4" x 2"	
65543DT	4" x 3"	

WARNING: This product can expose you to chemicals, including Nickel, which are known to the State of California to cause cancer. For more information, visit www.P65Warnings.ca.gov

STEEL FITTINGS

FITTINGS AND NIPPLES

STEEL FITTINGS

This will certify that the material was manufactured in accordance with ASME B16.14 - 1991 Standards. All Threads are Dryseal (NPTF) - 3/4 inch taper per foot and are made of Carbon Steel 12L14. Pressure rating: 150/300 PSI

- Clear Zinc plating specifications ASTM B633-07
- Federal Specification QQ-Z-325 (Zinc Plate)
- Type III with supplemental clear Trivalent chromate
- .00015" Zinc (Minimum)
- ROHS Compliant
- Lead Free

HEX BUSHINGS



PART # ZINC	LIST PRICE	SIZE M X F	A	HEX	APPROX. WT. LBS.	PART # BLACK	LIST PRICE
66500	---	1/4" x 1/8"	0.63	0.62	0.02	67500	---
66501	---	3/8" x 1/8"	0.66	0.68	0.04	67501	---
66502	---	3/8" x 1/4"	0.66	0.68	0.02	67502	---
66503	---	1/2" x 1/8"	0.80	0.87	0.10	67503	---
66504	---	1/2" x 1/4"	0.80	0.87	0.08	67504	---
66505	---	1/2" x 3/8"	0.80	0.87	0.06	67505	---
66506	---	3/4" x 1/8"	0.94	1.06	0.18	67506	---
66507	---	3/4" x 1/4"	0.94	1.06	0.14	67507	---
66508	---	3/4" x 3/8"	0.94	1.06	0.14	67508	---
66509	---	3/4" x 1/2"	0.94	1.06	0.10	67509	---
66510	---	1" x 1/4"	1.00	1.31	0.16	67510	---
66511	---	1" x 3/8"	1.00	1.31	0.26	67511	---
66512	---	1" x 1/2"	1.00	1.31	0.22	67512	---
66513	---	1" x 3/4"	1.00	1.31	0.14	67513	---

FACE BUSHING

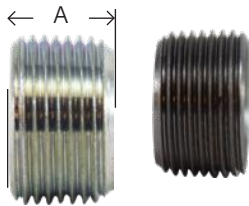

PART # ZINC	LIST PRICE	SIZE M X F	A	APPROX. WT. LBS.	PART # BLACK	LIST PRICE
	---	1/4" x 1/8"	0.44	0.01	67700	---
	---	1/2" x 1/4"	0.56	0.04	67704	---
	---	1/2" x 3/8"	0.56	0.04	67705	---
	---	3/4" x 1/2"	0.62	0.10	67709	---
66713	---	1" x 3/4"	0.75	0.16	67713	---

CAPS



PART # ZINC	LIST PRICE	SIZE NPTF	A	HEX	APPROX. WT. LBS.	PART # BLACK	LIST PRICE
66470	---	1/8"	0.53	0.56	0.02	67470	---
66471	---	1/4"	0.63	0.62	0.04	67471	---
66472	---	3/8"	0.69	0.81	0.06	67472	---
66473	---	1/2"	0.87	1.00	0.12	67473	---
66474	---	3/4"	0.97	1.18	0.16	67474	---
	---	1"	1.16	1.50	0.30	67475	---
	---	1-1/4"	1.28	2.00	0.68	67476	---
	---	1-1/2"	1.35	2.25	0.83	67477	---

WARNING: This product can expose you to chemicals, including Nickel, which are known to the State of California to cause cancer. For more information, visit www.P65Warnings.ca.gov

FITTINGS & NIPPLES

STEEL FITTINGS

FITTINGS AND NIPPLES

This will certify that the plugs are dimensional per SAE J531 MAY 95 Standards. All threads are Dryseal (NPTF) - 3/4" Taper per foot and are made of SAE J403 Low Carbon Steel 1010 Cold headed.

SQUARE HEAD PLUGS

• SOLID

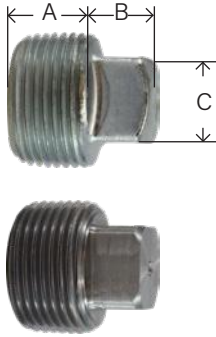

PART # ZINC	LIST PRICE	SIZE NPTF	A	B	C	APPROX. WT. LBS.	PART # BLACK	LIST PRICE
66670	---	1/8"	0.33	0.24	0.28	0.01	67670	---
66671	---	1/4"	0.45	0.28	0.37	0.02	67671	---
66672	---	3/8"	0.50	0.31	0.43	0.04	67672	---
66653	---	1/2"	0.59	0.38	0.55	0.12	67653	---
66654	---	3/4"	0.63	0.44	0.62	0.18	67654	---
66655	---	1"	0.75	0.5	0.81	0.34	67655	---
66656	---	1-1/4"	0.80	0.56	0.93	0.62	67656	---
66657	---	1-1/2"	0.83	0.62	1.12	0.82	67657	---
66658	---	2"	0.88	0.68	1.31	1.36	67658	---

HEX HEAD PLUGS

• SOLID



PART # ZINC	LIST PRICE	SIZE NPTF	A	HEX	APPROX. WT. LBS.	PART # BLACK	LIST PRICE
66770	---	1/8"	0.55	0.43	0.01	67770	---
66771	---	1/4"	0.74	0.56	0.04	67771	---
66772	---	3/8"	0.67	0.68	0.06	67772	---
66773	---	1/2"	0.80	0.70	0.12	67773	---
66774	---	3/4"	0.94	1.06	0.18	67774	---
66775	---	1"	1.00	1.31	0.22	67775	---
66776	---	1-1/4"	1.17	1.75	0.7	67776	---
66777	---	1-1/2"	1.51	2.00	1.2	67777	---
66778	---	2"	1.65	2.50	2.06	67778	---

COUNTERSUNK PLUG - SQUARE SOCKET



PART # ZINC	LIST PRICE	SIZE NPTF	A	SOCKET SIZE	APPROX. WT. LBS.	PART # BLACK	LIST PRICE
66630	---	1/8"	0.29	0.19	0.01	67630	---
66631	---	1/4"	0.45	0.25	0.02	67631	---
66632	---	3/8"	0.45	0.31	0.04	67632	---
66633	---	1/2"	0.59	0.38	0.08	67633	---
66634	---	3/4"	0.60	0.50	0.12	67634	---
66635	---	1"	0.75	0.50	0.16	67635	---
66636	---	1-1/4"	0.80	0.75	0.32	67636	---
66637	---	1-1/2"	0.83	0.75	0.45	67637	---
66638	---	2"	0.88	0.875	2.06	67638	---

COUNTERSUNK PLUG - HEX SOCKET



PART # ZINC	LIST PRICE	SIZE NPTF	A	SOCKET SIZE	APPROX. WT. LBS.	PART # BLACK	LIST PRICE
66760	---	1/16"	0.29	0.15	0.01	67760	---
66761	---	1/8"	0.29	0.18	0.01	67761	---
66762	---	1/4"	0.44	0.25	0.02	67762	---
66763	---	3/8"	0.44	0.31	0.04	67763	---
66764	---	1/2"	0.59	0.37	0.08	67764	---
66765	---	3/4"	0.60	0.56	0.14	67765	---
66766	---	1"	0.75	0.625	0.22	67766	---
66767	---	1-1/4"	0.80	0.75	0.37	67767	---
66768	---	1-1/2"	0.83	1.0	0.45	67768	---
66769	---	2"	0.88	1.0	0.86	67769	---

* SLOTTED AND FLUSH PLUGS AVAILABLE UPON REQUEST

WARNING: This product can expose you to chemicals, including Nickel, which are known to the State of California to cause cancer. For more information, visit www.P65Warnings.ca.gov

BLACK EXTRA HEAVY 300# IRON

FITTINGS AND NIPPLES

300# MALLEABLE

90° ELBOW



PART #	SIZE	LIST PRICE
69101	1/4"	---
69102	3/8"	---
69103	1/2"	---
69104	3/4"	---
69105	1"	---
69106	1-1/4"	---
69107	1-1/2"	---
69108	2"	---

45° ELBOW



PART #	SIZE	LIST PRICE
69181	1/4"	---
69182	3/8"	---
69183	1/2"	---
69184	3/4"	---
69185	1"	---
69186	1-1/4"	---
69187	1-1/2"	---
69188	2"	---

90° STREET ELBOW



PART #	SIZE	LIST PRICE
69161	1/4"	---
69162	3/8"	---
69163	1/2"	---
69164	3/4"	---
69165	1"	---
69166	1-1/4"	---
69167	1-1/2"	---
69168	2"	---

TEE



PART #	SIZE	LIST PRICE
69252	3/8"	---
69253	1/2"	---
69254	3/4"	---
69255	1"	---
69256	1-1/4"	---
69257	1-1/2"	---
69258	2"	---

COUPLING



PART #	SIZE	LIST PRICE
69411	1/4"	---
69412	3/8"	---
69413	1/2"	---
69414	3/4"	---
69415	1"	---
69416	1-1/4"	---
69417	1-1/2"	---
69418	2"	---

WARNING: This product can expose you to chemicals, including Nickel, which are known to the State of California to cause cancer. For more information, visit www.P65Warnings.ca.gov

FITTINGS & NIPPLES

BLACK EXTRA 300# IRON

FITTINGS AND NIPPLES

REDUCING COUPLING



PART #	SIZE	LIST PRICE
69432	3/8 x 1/4"	---
69434	1/2 x 1/4"	---
69435	1/2 x 3/8"	---
69438	3/4 x 1/2"	---
69441	1 x 1/2"	---
69442	1 x 3/4"	---

CAP



PART #	SIZE	LIST PRICE
69471	1/4"	---
69472	3/8"	---
69473	1/2"	---
69474	3/4"	---
69475	1"	---
69476	1-1/4"	---
69477	1-1/2"	---
69478	2"	---

UNION

• BRASS SEAT



PART #	SIZE	LIST PRICE
69600	1/8"	---
69601	1/4"	---
69602	3/8"	---
69603	1/2"	---
69604	3/4"	---
69605	1"	---
69606	1-1/4"	---
69607	1-1/2"	---
69608	2"	---

STEEL MAGNETIC PLUGS

STEEL MAGNETIC DRAIN PLUGS - NPT THREADED

Magnetic Drain Plugs are similar to standard pipe or straight thread drain plugs with one important difference - a permanent magnet is fastened to the plug body. This magnet attracts and holds abrasive, ferrous metal particles preventing their circulation through the lubrication or hydraulic system.

These abrasive, ferrous metal particles appear in lubricating or hydraulic systems as a result of the following conditions:

- The constant flaking effect of normal wear of moving parts.
- Particles not removed by flushing operations after boring or machining.
- Chipping due to sub-surface casting flaws.
- Minute component breakdown caused by stress usage.

Magnetic Drain Plugs prevent excessive wear to the system's components.

Magnetic Plugs are used by numerous manufacturers of gear boxes, transmissions, engines, and hydraulic systems for the automotive, aircraft, agricultural and machinery industries.

Typical applications include:

- Outboard Engines
- Earthmoving Equipment
- Combines
- Balers
- Crawler Tractors
- Lift Trucks
- Mining Equipment
- Military Vehicles
- Turbine Engines
- Truck Axles

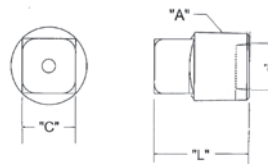

PART	SIZE "A"	HEAD WIDTH "C"	RECESS DIA. "H"	O/L LENGTH "L"	LIST PRICE
28996	3/8 - 18	.428 - .440	.435 - .445	.805 - .860	---
28997	1/2 - 14	.553 - .565	.560 - .570	.970 - 1.04	---
28998	3/4 - 14	.615 - .627	.725 - .735	1.120 - 1.170	---
28999	1-11/2	.803 - .815	.895 - .905	1.25 - 1.33	---

WARNING: This product can expose you to chemicals, including Nickel, which are known to the State of California to cause cancer. For more information, visit www.P65Warnings.ca.gov

BULL PLUGS AND SWAGS

FITTINGS AND NIPPLES

BULL PLUGS AND SWAGES

STANDARD BULL PLUG

- SCH 40 150#
- ZINC PLATED



PART #	DESCRIPTION	LIST PRICE
91008	2"	---
	2" w/ 1/2" TAP	---
	2-1/2"	---
	3"	---
91011	4"	---

XH BULL PLUG

- MADE FROM SCH. 80 PIPE.
- ZINC PLATED
- HOLLOW



PART #	DESCRIPTION	LIST PRICE
	1/4"	---
90005	1"	---
	1-1/4"	---
	1-1/2"	---
90008	2"	---
90212	2" w/ 1/2" TAP	---
93212*	2"XXH w/1/2" TAP	---
	2-1/2"	---
90010	3"	---
90215	3" w/ 1/2" TAP	---
90011	4"	---

* XXH

STANDARD SCH. 40 SWAGE MIP X MIP

- ZINC PLATED



PART #	DESCRIPTION	LIST PRICE
93113	1-1/4" x 1"	---
93121	2" x 1"	---
93123	2" x 1-1/2"	---
	2-1/2" x 2"	---
93124	3" x 1"	---
93127	3" x 1-1/2"	---
93128	3" x 2"	---
	3" x 2-1/2"	---
93130	4" x 2"	---
93131	4" x 3"	---
93139	6" x 3"	---

WARNING: This product can expose you to chemicals, including Nickel, which are known to the State of California to cause cancer. For more information, visit www.P65Warnings.ca.gov

FITTINGS & NIPPLES

SWAGES

FITTINGS AND NIPPLES

SCH 80 XH SWAGES MIP X MIP



* HEX STYLE



XXH SWAGE



PART #	DESCRIPTION	LIST PRICE
	1/4" x 1/8"	---
90102	1/2" x 1/4"	---
90103*	1/2" x 3/8"	---
90104*	3/8" x 1/4"	---
90105*	3/4" x 1/4"	---
90106*	3/4" x 3/8"	---
90107*	3/4" x 1/2"	---
	1" x 1/4"	---
	1" x 3/8"	---
90110*	1" x 1/2"	---
90111*	1" x 3/4"	---
90140	1-1/4" x 3/4"	---
90141	1-1/4" x 1"	---
90114	1-1/2" x 1/2"	---
90115	1-1/2" x 3/4"	---
90116	1-1/2" x 1"	---
90117	1-1/2" x 1-1/4"	---
	2" x 1/4"	---
90119	2" x 1/2"	---
90120	2" x 3/4"	---
90121	2" x 1"	---
90122	2" x 1-1/4"	---
90123	2" x 1-1/2"	---
90124	2-1/2" x 2"	---
	3" x 1"	---
90128	3" x 2"	---
	3" x 2-1/2"	---
	4" x 1"	---
90130	4" x 2"	---
90131	4" x 3"	---
90132	6" x 4"	---
	6" x 2"	---
90150	6" x 3"	---

PART #	DESCRIPTION	LIST PRICE
	1/2" x 1/4"	---
92107	3/4" x 1/2"	---
	1" x 1/4"	---
	1" x 3/8"	---
	1" x 3/4"	---
	1-1/2" x 1/2"	---
	1-1/2" x 3/4"	---
92116	1-1/2" x 1"	---
	2" x 1/2"	---
	2" x 3/4"	---
92121	2" x 1"	---
	2" x 1-1/4"	---
	2" x 1-1/2"	---
92128	3" x 2"	---

WARNING: This product can expose you to chemicals, including Nickel, which are known to the State of California to cause cancer. For more information, visit www.P65Warnings.ca.gov