

HOSE, CORD & CABLE

REELS

COXREELS SINCE 1923

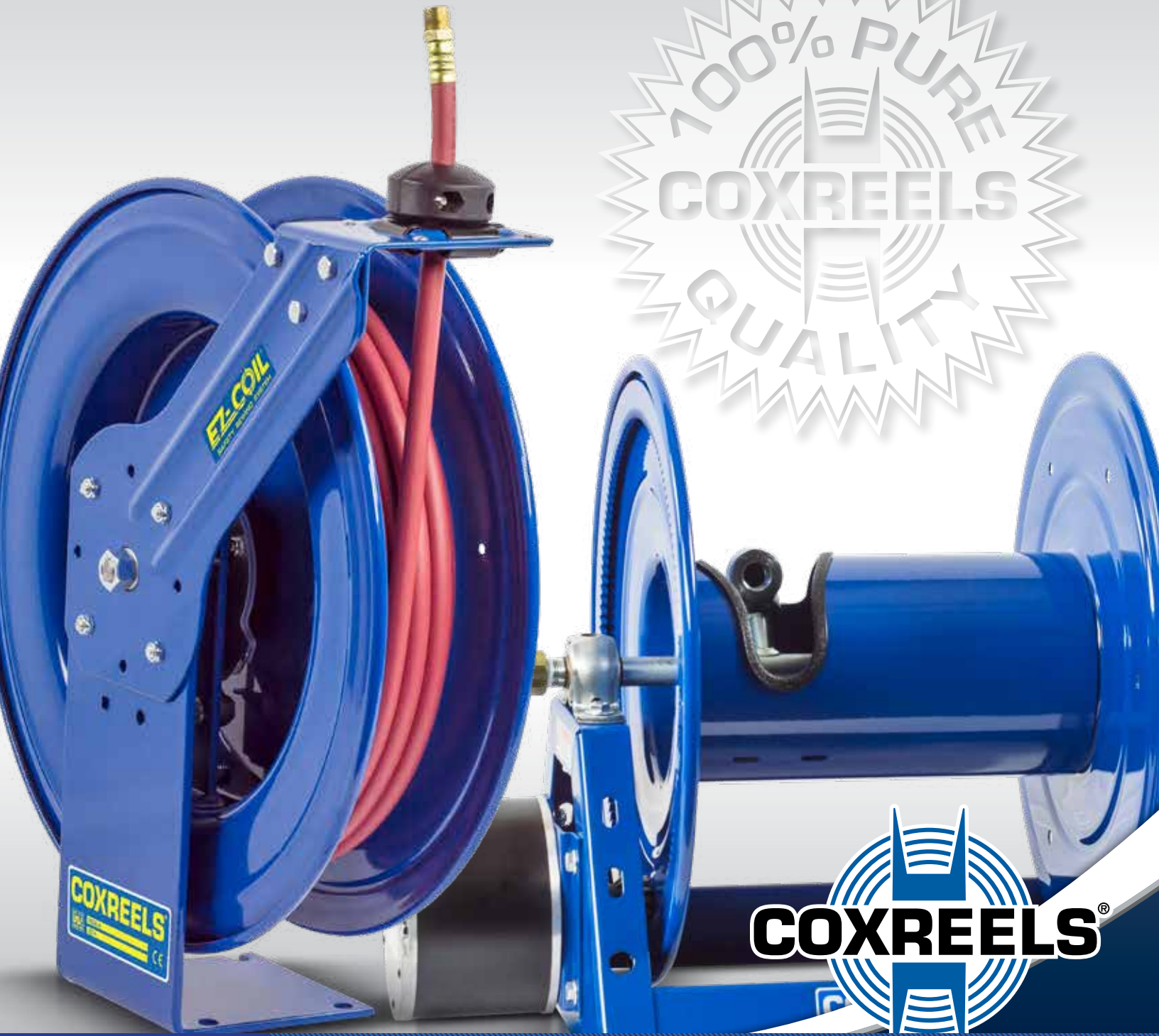

GOODYEAR
RUBBER PRODUCTS, INC.

☎ 727-342-5088

You can also email us at
GRP@goodyearrubberproducts.com



OUR MISSION

WE WILL LEAD THE INDUSTRY IN QUALITY & INNOVATION

We know that there can be no compromise when you live the philosophy of building the best! Every decision regarding our product design is made with one unwavering goal...



TO MAKE THE REQUIRED PRODUCT THE VERY BEST IT CAN BE.

YOUR REEL SOURCE



A HIGHER LEVEL OF STANDARDS



CPCT™ POWDER COAT
Our blue powder coat finish is long lasting, chip resistant & rust inhibiting



BRASS SWIVEL
External fluid path, machined from solid brass, full flow, swivel for simple seal maintenance



STEEL AXLE
1" solid steel axle & lubricated bearings for extra strength & durability. Not a hollow tube & no fluid travels through it



CNC SPUN DISCS
All steel rolled edges & ribbed discs for added safety, strength & durability



CARTRIDGE MOTOR
Enclosed factory tuned & matched cartridge style motor for safe & easy replacement



EZ-COIL® SERIES
A patented safety system that retracts up to 80% slower than conventional reels



SPRING DRIVEN REELS OVERVIEW

	MATERIAL	LENGTH	MAX
GENERAL:	HOSE I.D. 1/4" - 1 1/2"	15' - 100'	300 - 5,000 PSI
FUEL:	HOSE I.D. 1/2" - 1"	25' - 75'	300 PSI
WELDING HOSE:	HOSE I.D. 1/4"	25' - 100'	200 PSI
WELDING CABLE:	CABLE GA: #6 - #2/0	25' - 50'	75 AMPS - 450 AMPS

	MATERIAL	LENGTH	MAX
ELECTRICAL:	CORD GA: 10 - 16 GA	30' - 100'	13 - 35 AMPS
STATIC DISCHARGE:	CABLE SIZE: 5/32"	35' - 100'	50 - 100 AMPS
VACUUM:	HOSE I.D. 1 1/2"	25'	29" HG

WARNING: Cancer and reproductive Harm - See page 22 of MSDS

GOODYEAR
RUBBER PRODUCTS, INC.

727-342-5088

You can also email us at
GRP@goodyearrubberproducts.com

Dear Valued Customer,

Thank you for choosing COXREELS!

Entering into our 10th decade under the 3rd generation of family ownership and operation, we are proud to manufacture the industry's highest quality and widest variety of hose, cord, and cable reels. We remain aware that our products are called on to be the most reliable product built to faithfully perform in various settings and applications.

Our team takes great pride in our growth and innovation as a U.S. manufacturer. We recognize USA Made, USA Quality, and USA Support as critical components to delivering incomparable product value. These founding principles are displayed and reflected in each model and every part of the Coxreels product

line! Our advanced engineering and manufacturing processes make extensive use of in-house design, CNC machinery with robotic welding and robotic spin cell operations, and modern automation systems that allow us to develop and build state-of-the-art reeling platform solutions that meet the most demanding requirements in the industry.

In these pages you will see the quality, variety, value and innovation that has made us a world leading reel manufacturer. Over 90 years as the industry leader proves that constant learning and communication with the industries we serve, innovative engineering and the highest standards in quality and service ensure we will continue to innovate with new proprietary technologies, superior special

features and superior products that set the bar in the reel industry.

I also would like to offer my thanks to all of our customers who are the cornerstone of this business. It is with your support that we drive our position of leadership and innovation to new heights each and every year.



Sincerely,

Brad Cox :: President



SUPER HUB

1/4" steel frame & support arm with dual axle support with SUPER HUB™ for increase strength & durability

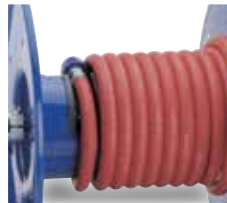

LOW PROFILE RISER

Low profile riser with open drum slot allows for smooth even hose wraps that will not pinch or bind your hose. **NO HUMP!**



ALL WELDED STEEL "A" FRAME

All welded steel "A" frame for strength & durability. **NOT BOLTED!**



DIRECT DRIVE MOTORS

A solid steel ring gear is welded to the disc for a direct gear driven motor



2 YEAR WARRANTY

Coxreels proudly stands behind our reels as they are built to last!



USA MADE, QUALITY & SUPPORT

We take great pride in designing, building & supplying the world's finest reels made right here in the U.S.A.

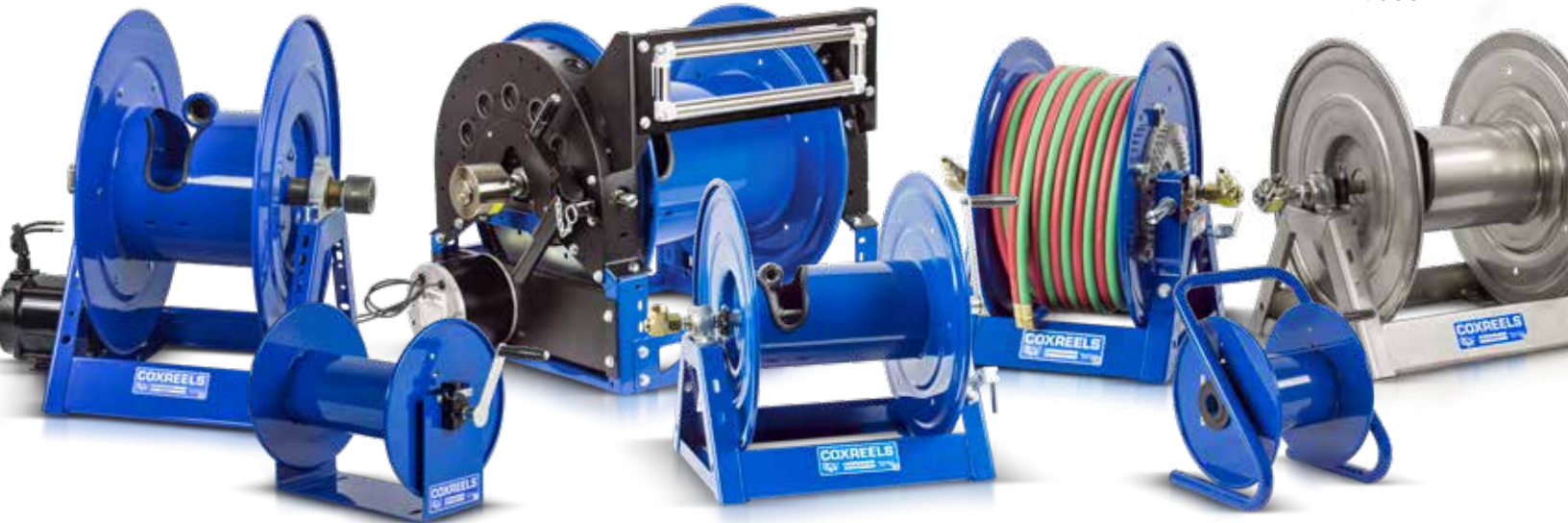

HAND CRANK & MOTORIZED REELS OVERVIEW

	MATERIAL	LENGTH	MAX
GENERAL:	HOSE I.D. 3/8" – 2"	50' – 700'	600 – 10,000 PSI
WELDING GAS	HOSE I.D. 1/4" – 3/8"	50' – 250'	200 PSI
WELDING CABLE	CABLE GA: #2 – #2/0	100' – 600'	450 AMPS

	MATERIAL	LENGTH	MAX
STATIC DISCHARGE	CABLE SIZE: 5/32"	200' – 250'	50 – 100 AMPS
ELECTRICAL:	CORD GA: 10 – 12 GA	200' – 250'	30 – 45 AMPS
VACUUM:	HOSE I.D. 1 1/2"	50'	29" HG



WARNING: Cancer and reproductive Harm – See page 886 of SDS for details.

GOODYEAR
RUBBER PRODUCTS, INC.

727-342-5088

You can also email us at
GRP@goodyearrubberproducts.com

INDEX

OUR MISSION

MESSAGE FROM THE PRESIDENT pg **2-3**

SPRING DRIVEN

EZ-COIL & FEATURE FOCUS..... pg **7-9**

SPRING DRIVEN

REELS..... pg **10-37**

HAND CRANK & MOTOR DRIVEN

FEATURE FOCUS pg **38-39**

HAND CRANK & MOTOR DRIVEN

REELS..... pg **40-55**

SPRING DRIVEN











ACCESSORIES pg **56-57**











HAND CRANK & MOTOR DRIVEN

ACCESSORIES pg **58-60**

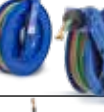

HOW TO ORDER

TO GET THE PERFECT REEL..... pg **61**

SERIES	PAGE	SPRING DRIVEN	HAND CRANK	MOTORIZED	HOSE I.D. / CORD GA	MAX PSI / AMPS
 LG Series Compact hose reels	10	•			1/4" - 3/8"	300
 P / EZ-P Series Performance hose reels	11	•			1/4" - 1/2"	Up to 5,000
 SH / EZ-SH Series Heavy duty Super Hub™ hose reels	12	•			1/4" - 3/4"	Up to 5,000
 T / EZ-T Series Supreme duty "truck mount" reels with Super Hub™ & a full frame	13	•			1/4" - 1"	Up to 5,000
 XTM Series Extreme Duty Reels	14	•			3/8" - 1"	Up to 4,000
 EN / EZ-EN Series Enclosed hose reels	15	•			1/4" - 1/2"	Up to 5,000
 S / EZ-S Series Side mount hose reels	16	•			1/4" - 1/2"	Up to 5,000
 SG / EZ-SG Series Side mount hose reels with guide arm						
 SP Series Single high capacity hose reels	17	•			1/2" - 1 1/2"	Up to 2,500
 DP Series Dual high capacity hose reels	18	•			3/8" - 3/4"	Up to 3,000
 C Series "2 in 1" hose reels	19	•			1/4" - 1/2"	Up to 5,000

SERIES	PAGE	SPRING DRIVEN	HAND CRANK	MOTORIZED	HOSE I.D. / CORD GA	MAX PSI / AMPS
 C Air/Electric Series "2 in 1" hose & cord reels	20	•			1/4" 12 GA-16 GA	Up to 300 / 25A
 PC10 Series Compact power cord reels	21	•			12 GA-16 GA	Up to 20A
 PC Series Power cord reels	22	•			10 GA-16 GA	Up to 35A
 P-W & SH-W / EZ-PW & EZ-SHW Series Welding hose reels	24	•			1/4"	200
 SW Series Side mount reels	25	•			1/4"	200
 SGW / EZ-SGW Series Side mount welding reels with guide arm						
 P-WC Series Welding cable reels	26	•			#2/0 GA - #6 GA	Up to 450A
 MPD, TDMP & 1275HP Series Dual hydraulic hose reels	27	•	•	•	1/4" - 1/2"	Up to 10,000
 SD & SDH / EZ-SD Series Static discharge cable reels	28	•	•		3/32"	Up to 100A
 DEF Series DEF hose reels	29	•			1/2" - 1"	300
 Fuel Series Fuel hose reels	30	•			1/2" - 1"	300

INDEX

SERIES	PAGE	SPRING DRIVEN	HAND CRANK	MOTORIZED	HOSE I.D. / CORD GA	MAX PSI / AMPS	SERIES	PAGE	SPRING DRIVEN	HAND CRANK	MOTORIZED	HOSE I.D. / CORD GA	MAX PSI / AMPS
 E / EZ-E Series Expandable bank system hose reels	31	•			1/4" - 1/2"	Up to 5,000	 1125 Series Hand crank & motor driven hose reels	44	•	•		3/8" - 1"	Up to 5,000
 Hi-Vis Series Hi-Visibility Safety Hose Series	32	•			3/8" - 1/2"	300	 1175 Series Hand crank & motor driven hose reels	45	•	•		3/4" - 1"	Up to 3,000
 Nitro-Pro & Alumi-Pro Series Aluminum hose reels & nitrogen hose reels	33	•			1/4" - 1/2"	300	 1185 Series Large capacity / volume hose reels	46	•	•		1 1/4" - 1 1/2"	Up to 3,000
 Pure Flow Series Breathing air & clean fluid hose reels	34	•	•	•	3/8" - 1/2"	Up to 6,000	 1195 Series Large capacity / volume hose reels	47	•	•		1 1/2" - 2"	Up to 600
 SS P, SH, T & EN Series Stainless steel hose reels	35	•			3/8" - 3/4"	Up to 3,000	 1600 Series Hand crank & motorized hybrid frame hose reels	48	•	•		1 - 1 1/2"	4,000
 300 Series Exhaust hose reels	36	•			4" - 6"	-	 1275 Series Large capacity dual hose reels	50	•	•		1/2" - 1"	Up to 3,000
 V Series Vacuum hose reels	37	•	•		1 1/2"	-	 1125PC Series Large capacity power cord reels	51	•	•		10GA - 12GA	Up to 45A
 100 Series Compact hose reels	40		•		3/8" - 3/4"	Up to 4,000	 100W & 1275W-C Series Large capacity welding hose reels	52	•	•		1/4" - 3/8"	200
 CM & DM Series Portable hose reels	41		•		3/8" - 1/2"	Up to 4,000	 100WCL & 1125WCL Series Welding cable reels	53	•	•		#2/0GA - #2GA	Up to 450A
 SM Series Swivel mount hose reels	42		•		1/4" - 1/2"	Up to 4,000	 SS 100, 1125 & 1175 Series Stainless steel hose reels	54	•	•		3/8" - 1"	Up to 4,000
 112Y Series Compact hose, cord & cable storage reels	43		•		3/8" - 1/2" 8GA - 16GA	-	 Storage Series Large capacity hose, cord & cable storage reels	55	•	•		1/4" - 3"	-

RESOURCES & MEDIA

Catalogs

MAIN CATALOG

Two size formats
8.5 x 11" / A4

Imperial and metric
size conversions

INDUSTRY CATALOGS

Agricultural/Pest Control
Automotive
Aviation
Construction
Fire Station
Fire Apparatus
Marine
Pressure Washing
Utility- Service Truck

PRODUCT CATALOGS

Electrical Cord Reels
Welding Reels
Fuel & DEF Reels
Stainless Steel Reels



- EZ-Coil Catalog

COMPLETE INTERACTIVE ONLINE RESOURCE

www.coxreels.com

- Complete Product Line Offering
- Responsive to All Devices
- Reel Selector
- Dynamic Quote Request Form
- Product Features/Benefits Videos
- Maintenance Videos
- Complete Product Catalogs
- Complete Industry Catalogs
- Feature Focus, Trifold & Channel Flyers
- Blogs
- Tech Support
- New Releases & much more

FOLLOW US



GOODYEAR
RUBBER PRODUCTS, INC.

727-342-5088

You can also email us at
GRP@goodyearrubberproducts.com

EZ-COIL®

SAFETY CONTROLLED RETRACTION

COXREELS Safety Series reels featuring the patented EZ-Coil® Rewind Safety System, engineered and developed exclusively by Coxreels, are the only choice for safe spring driven hose, cord and cable reel operation in the workplace. EZ-Coil® works uni-directionally without any increase to the amount of resistance when pulling out the hose, cord or cable. But, when engaged upon recoil, it controls the aggressive spring motor energy resulting in a reel that retracts at a safe and steady pace!

INCREASED SAFETY HOW?

- ▶ Reduce retraction speed by up to 80%
- ▶ Control hose or cord whip hazard
- ▶ Requires no external power source
- ▶ Enhance operator & workplace safety
- ▶ Keep your workplace organized
- ▶ Utilize space & maximize efficiency
- ▶ Improve hose, cord & cable management
- ▶ Extend longevity of hose, cord & cable
- ▶ Increase productivity



SPRING DRIVEN

UP TO 80% Slower Retraction

	Conventional SPRING DRIVEN REELS	COXREELS EZ-COIL
SPEED	25 ft./sec.	5 ft./sec.
WHIPPING	5-15 ft.	1 ft.
IMPACT	500 ft./lbs.	0-1 ft./lbs.

Based on an independent evaluation performed by COXREELS. Depending on certain conditions, results may vary.



Go online to view **EZ-COIL** catalog & videos of features & benefits at www.COXREELS.com

FOCUS ON THE FEATURES *SPRING DRIVEN REELS*



PROFESSIONAL GRADE FEATURES :: HOSE REELS



Go online to view videos of features & benefits
www.COXREELS.com

HEAVY DUTY SPUN DISCS with rolled edges for greater strength, made with first of its kind CNC robotic spin cell

ADJUSTABLE SOLID RUBBER HOSE STOP for lead length positioning

VERSATILE GUIDE ARM made from 10 gauge steel with stamped ribs for added rigidity, adjusts to wall, floor, ceiling & vehicle mounting

SPIRAL HOSE GUARD protects hose against premature wear

SOLID STEEL ZINC PLATED LOCKING RING offers 8 ratchet positions per rotation for ease of use

LOCKING PAWL, SPECIALLY ANGLED prevents lockout, both pawl and spring are from stainless steel for trouble free longevity

EXTERNAL FLUID PATH MACHINED FROM SOLID BRASS 90° FULL-FLOW NPT SWIVEL that screws directly on 1" solid steel axle, provides simple seal maintenance & fast and easy hose installation

HIGH QUALITY STEEL CONSTRUCTION with our durable CPC™ powder coat finish

ENCLOSED FACTORY TUNED AND MATCHED CARTRIDGE-STYLE SPRING MOTOR for safe & easy maintenance

HEAVY GAUGE 1/4" STEEL BASE & SUPPORT POST, SINGLE PIECE CONSTRUCTION WITH NO WELDS for maximum stability

SUPER HUB™ EQUIPPED MODELS: INCREASED REEL STRENGTH for more demanding applications with multiple support to the axle

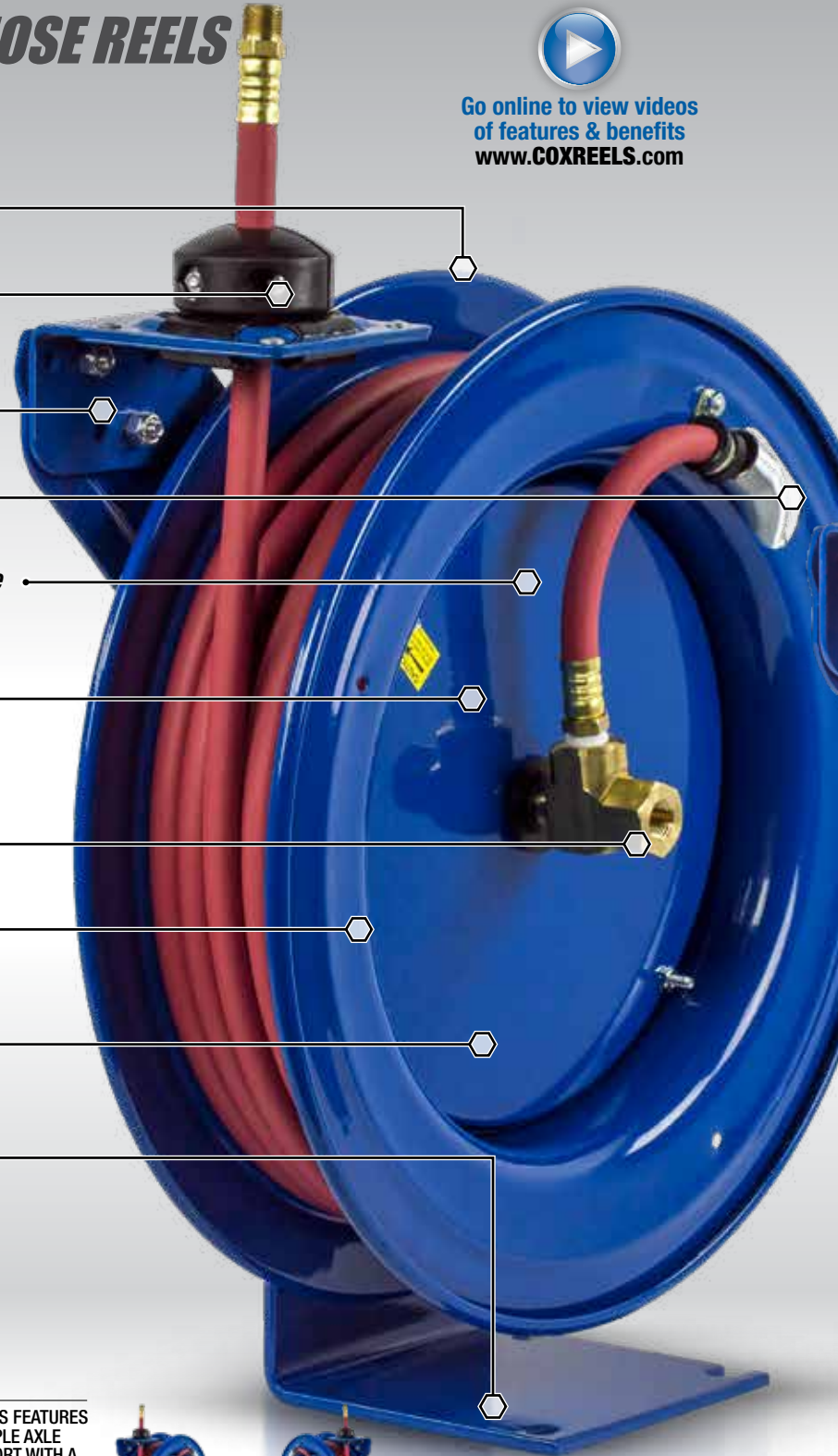

SPRING DRIVEN



SH, MP & HP SERIES FEATURES DUAL AXLE SUPPORT WITH SUPER HUB™

T SERIES FEATURES TRIPLE AXLE SUPPORT WITH A FULL FRAME & SUPER HUB™

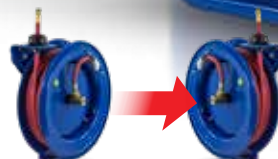

MIRROR YOUR REEL
Reverse your reel with suffix option **-BXR**

GOODYEAR
RUBBER PRODUCTS, INC.

727-342-5088

You can also email us at
GRP@goodyearrubberproducts.com

CORD REELS :: PROFESSIONAL GRADE FEATURES

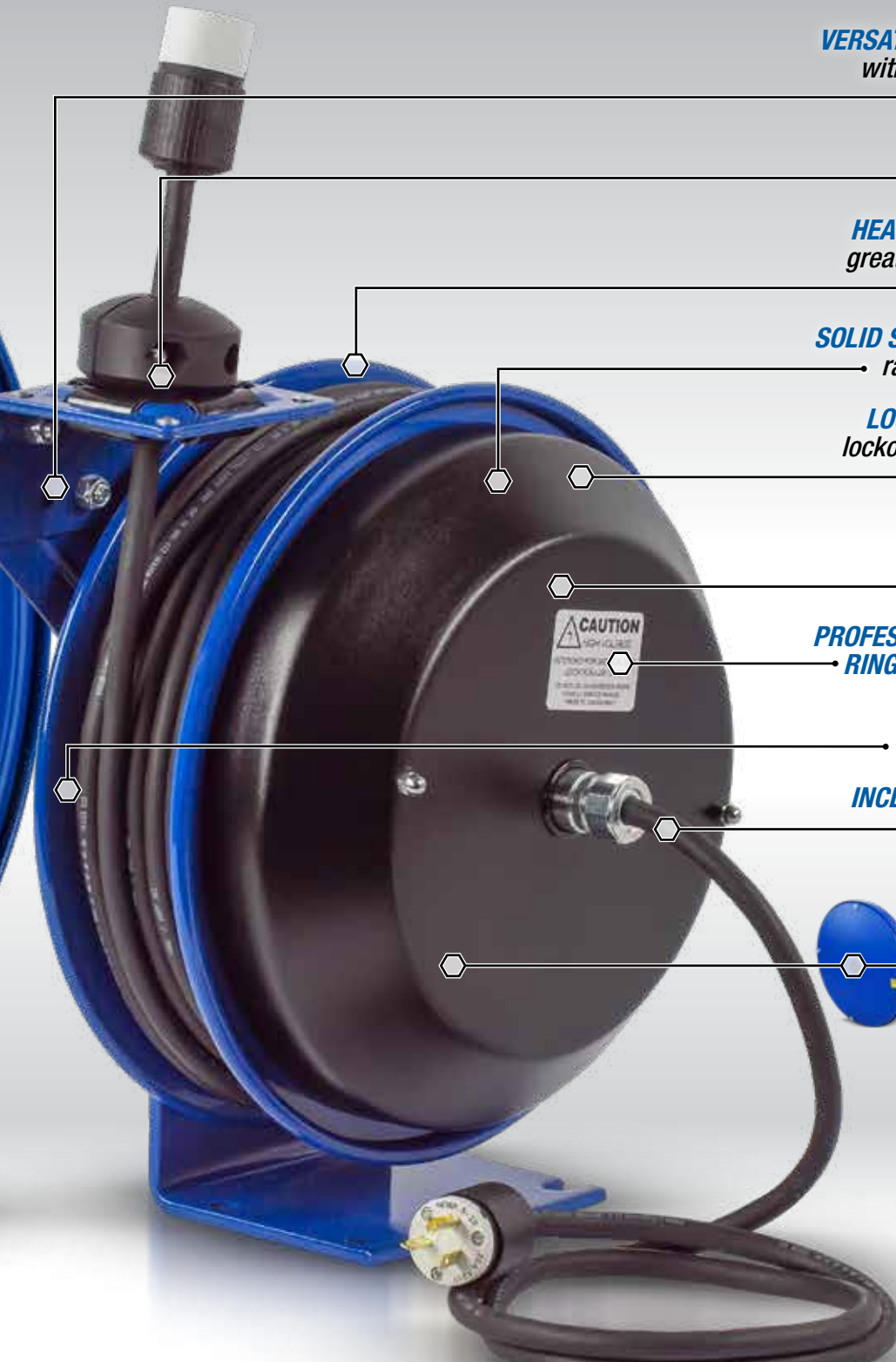

VERSATILE GUIDE ARM made from 10 gauge steel with stamped ribs for added rigidity, adjusts to
 • wall, floor, ceiling & vehicle mounting

ADJUSTABLE SOLID RUBBER HOSE STOP
 • for lead length positioning

HEAVY DUTY SPUN DISCS with rolled edges for greater strength, made with first of its kind CNC
 • robotic spin cell

SOLID STEEL ZINC PLATED LOCKING RING offers 8
 • ratchet positions per rotation for ease of use

LOCKING PAWL, SPECIALLY ANGLED prevents lockout, both pawl and spring are from stainless
 • steel for trouble free longevity

HEAVY GAUGE POWDER COATED STEEL COMPONENTS COVER protecting the slip
 • ring & all electrical components

PROFESSIONAL GRADE COPPER CONDUCTOR SLIP RING delivers consistent and dependable power

HIGH QUALITY STEEL CONSTRUCTION with our durable CPC™ powder coat finish

INCLUDES 5' LEAD CABLE & GROUNDING PLUG
 (Except on less cord models)

ENCLOSED FACTORY TUNED & MATCHED CARTRIDGE-STYLE SPRING MOTOR for safe & easy maintenance
 (Located under protective component cover)

CHOICE OF ELECTRICAL ACCESSORIES

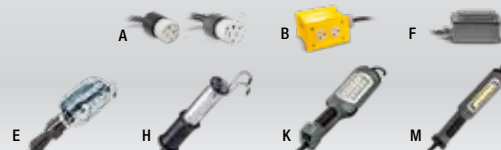

PC19 & PC24 MODELS
 FEATURES DUAL
 AXLE SUPPORT WITH
SUPER HUB™



SPRING DRIVEN

LG SERIES

COMPACT EFFICIENT HOSE & TUBING REELS

1/4" - 3/8" I.D.

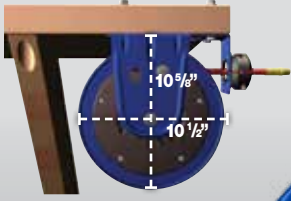

Under counter mounted for compact, out of the way storage



COXREELS® LG Series “Little Giant” is the first lightweight - heavy duty reel on the market. The LG is perfect for commercial or industrial applications where space or budget is limited. It is extremely lightweight and compact and can install almost anywhere. This little giant can accept either a 1/4" or 3/8" hose to tackle the jobs of reels almost double its size.

LG SERIES

Do not exceed listed hose O.D. to obtain maximum length.

HOSE						LESS HOSE		SIZE INDEX
MODEL	I.D.	O.D.	FT.	PSI	APRX. LBS.	MODEL	APRX. LBS.	
LOW PRESSURE						Models with hose are for air water service with a maximum temperature 150°F. Models less hose can be used for air, water or oil.		
LG-LP-115	1/4"	1/2"	15	300	9	LG-LPL-115	8	1
LG-LP-125	1/4"	1/2"	25	300	11	LG-LPL-125	8	1
LG-LP-310	3/8"	5/8"	10	300	9	LG-LPL-310	8	1
LG-LP-320	3/8"	5/8"	20	300	11	LG-LPL-320	8	1

LG SERIES :: REEL SPECIFICATIONS

SWIVEL

- External fluid path with machined from solid brass 90° full-flow NPT swivel
- Swivel Seals: NITRILE

DESIGN & STRUCTURE

- Compact & lightweight spring driven hose reel save space & facilitate workplace organization
- CoxComposite™ grommet with continuous radius design that does not pinch or catch the hose during operation
- Solid one piece, 12GA steel base & support post for maximum stability
- 1/2" solid steel axle & lubricated precision bearings for smooth rotation
- Designed for lightweight PVC hose & tubing

RETRACTION

- Enclosed factory tuned & matched cartridge-style spring motor
- Non-corrosive CoxComposite™ ratchet hub with self lubricating bronze bearings secures hose at desired length

SIGNATURE FEATURES

- Professional grade heavy duty steel construction
- Durable proprietary CPC™ powder coat process
- Rolled edges & ribbed discs provide strength & safety
- Leading 2-year manufacturer's limited warranty
- Made in the U.S.A. - Sold & Supported Worldwide

POSSIBLE FIELDS OF APPLICATION

- Pneumatic Tools
- Machine Shops
- Tubing Applications
- Maintenance, Repair & Operations
- Washdown
- Service / Mechanic / Utility Vehicles
- General Commercial & Industrial
- Bench Mount

ACCESSORIZE YOUR REEL :: PG 56

- O-Rings & Swivels
- Assorted Reel Accessories

REEL DIMENSIONS

Technical Data Sheets Available On Website

SIZE INDEX	W	H	L	X	Y	M	N
1	5 1/4"	10 5/8"	10 1/2"	4 11/16"	8 3/8"	2 1/2"	6"
	Overall Dimensions			Base		Mounting Pattern	

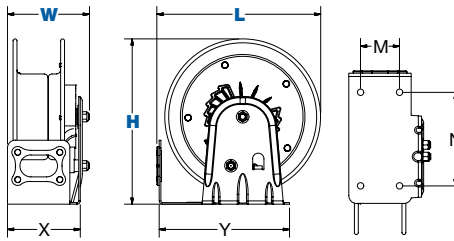

COXREELS® LG FEATURES



CoxComposite™ Hub Features

- Integrates High-Strength Composite With Self Lubricating Bronze Bearing
- Over 100% More Impact Strength Than Typical Glass Filled Polypropylene Used In Other Reels
- Strength Actually Increases By 20% At Sub-Zero Temperatures (Actual Test Results Measured At -40°C)
- Excellent Chemical Resistance

COXREELS® LG FEATURES



CoxComposite™ Grommet Features

- Continuous Radius Design Allows The Use Of Various Size Tubing In Addition To Standard Hose Sizes
- Absolutely No Pinching & No Place To Catch
- Bearing Grade, FDA-Compliant Composite
- Excellent Chemical Resistance

WARNING: Cancer and reproductive Harm – See page 22

SPRING DRIVEN

COXREELS® P Series "Performance" spring driven hose reels have a long history of dependability and trouble free performance. Their compact space-saving size and heavy duty construction make them highly versatile and virtually indestructible. Time-tested proven components, superior design and craftsmanship have contributed to it's worldwide reputation as the most trusted hose reel.

P SERIES

Do not exceed listed hose O.D. to obtain maximum length.

HOSE							LESS HOSE		SIZE INDEX
MODEL	I.D.	O.D.	FT.	PSI	APRX. LBS.	EZ-COIL MODELS	MODEL	APRX. LBS.	
LOW PRESSURE Models with hose are for air water service with a maximum temperature 150°F. Models less hose can be used for air, water or oil.									
P-LP-125	1/4"	1/2"	25	300	27	EZ-P-LP-125	P-LPL-125	24	1
P-LP-130	1/4"	1/2"	30	300	27	-	P-LPL-130	24	1
P-LP-135	1/4"	1/2"	35	300	28	EZ-P-LP-135	P-LPL-135	25	1
P-LP-140	1/4"	1/2"	40	300	38	-	P-LPL-140	34	3
P-LP-150	1/4"	1/2"	50	300	40	EZ-P-LP-150	P-LPL-150	35	3
P-LP-325	3/8"	5/8"	25	300	28	EZ-P-LP-325	P-LPL-325	25	2
P-LP-330	3/8"	5/8"	30	300	37	EZ-P-LP-330	P-LPL-330	33	3
P-LP-335	3/8"	5/8"	35	300	38	EZ-P-LP-335	P-LPL-335	34	3
P-LP-340	3/8"	5/8"	40	300	39	-	P-LPL-340	34	3
P-LP-350	3/8"	5/8"	50	300	43	EZ-P-LP-350	P-LPL-350	36	3
P-LP-415	1/2"	3/4"	15	300	41	-	P-LPL-415	38	4
P-LP-425	1/2"	3/4"	25	300	44	-	P-LPL-425	39	4
P-LP-430	1/2"	3/4"	30	300	45	EZ-P-LP-430	P-LPL-430	40	4
P-LP-450	1/2"	3/4"	50	300	48	EZ-P-LP-450	P-LPL-450	43	4
MEDIUM PRESSURE Reels are furnished with standard one wire braid hose suitable for air, water or oil applications. Hose exceeds SAE R1 specifications. Maximum Temperature 212°F (If used with water, synthetic fluids 135°F max.)									
P-MP-320	3/8"	1 1/16"	20	3,000	46	-	P-MPL-320	41	4
P-MP-325	3/8"	1 1/16"	25	3,000	49	-	P-MPL-325	42	4
P-MP-330	3/8"	1 1/16"	30	3,000	51	-	P-MPL-330	43	4
P-MP-335	3/8"	1 1/16"	35	3,000	52	-	P-MPL-335	43	4
P-MP-420	1/2"	1 3/16"	20	2,500	47	-	P-MPL-420	41	4
P-MP-425	1/2"	1 3/16"	25	2,500	49	EZ-P-MP-425	P-MPL-425	42	4
P-MP-430	1/2"	1 3/16"	30	2,500	51	EZ-P-MP-430	P-MPL-430	43	4
HIGH PRESSURE Reels are furnished standard with S.A.E. 100R16 #1 or #2 wire braid hose suitable for grease and hydraulic oil applications. Maximum Temperature 212°F. (If used with water, synthetic fluids 135°F max.)									
P-HP-120	1/4"	9/16"	20	5,000	46	-	P-HPL-120	41	4
P-HP-125	1/4"	9/16"	25	5,000	48	EZ-P-HP-125	P-HPL-125	42	4
P-HP-130	1/4"	9/16"	30	5,000	50	-	P-HPL-130	43	4
P-HP-135	1/4"	9/16"	35	5,000	51	-	P-HPL-135	43	4
P-HP-320	3/8"	1 1/16"	20	4,000	47	-	P-HPL-320	41	4
P-HP-325	3/8"	1 1/16"	25	4,000	49	EZ-P-HP-325	P-HPL-325	42	4
P-HP-330	3/8"	1 1/16"	30	4,000	51	-	P-HPL-330	43	4

To order EZ-Coil® equipped models less hose, please add prefix "EZ-"

REEL DIMENSIONS

Technical Data Sheets Available On Website

SIZE INDEX	W	H	L	X	Y	M	N
1	5 7/8"	14 7/8"	13 1/2"	5"	6"	3"	5"
2	6 1/2"	14 7/8"	13 1/2"	5"	6"	3"	5"
3	6 3/4"	18 5/8"	17 1/8"	6"	6"	4"	5"
4	7"	18 5/8"	17 1/8"	6"	6"	4"	5"

Overall Dimensions

Base

Mounting Pattern

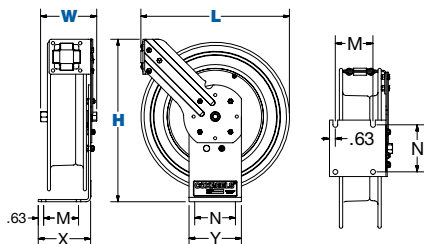

P SERIES :: REEL SPECIFICATIONS

SWIVEL

- External fluid path with machined from solid brass 90° full-flow NPT swivel inlet (Zinc plated steel swivel on HP models)
- Swivel Seals: NITRILE

DESIGN & STRUCTURE

- Sturdy single pedestal reel with space saving design facilitates workplace organization
- Guide arm adjusts to wall, floor, vehicle & overhead positions
- Solid one piece, heavy gauge 1/4" steel base & support post for maximum stability
- 1" solid steel axle & lubricated precision bearings for smooth rotation

RETRACTION

- Controlled retraction speed up to 80% slower on EZ-COIL models :: See page 7 for details
- Enclosed factory tuned & matched cartridge-style spring motor
- Non-corrosive stainless steel spring, pawl & zinc plated ratchet
- Multi-position lock ratchet mechanism secures hose at desired length

SIGNATURE FEATURES

- Professional grade heavy duty steel construction
- Durable proprietary CPC™ powder coat process
- Rolled edges & ribbed discs provide strength & safety
- Leading 2-year manufacturer's limited warranty
- Made in the U.S.A. - Sold & Supported Worldwide

POSSIBLE FIELDS OF APPLICATION

- Air/Water Services
- Pneumatic Tools
- Washdown
- Lubrication
- Chemical Fluid Transfer
- General Industrial
- Manufacturing Plants & Facilities
- Maintenance, Repair & Operations
- Automotive & Fleet Service Centers

ACCESSORIZE YOUR REEL :: PG 56

- O-Rings & Swivels
- Mounting Brackets
- Hoses
- Assorted Reel Accessories



WARNING: Cancer and reproductive Harm – See page 56

ENCLOSED HOSE REELS

EN SERIES

1/4" - 1/2" I.D.

COXREELS® EN Series "Enclosed" spring driven hose reels are protected by a powder coated steel casing that shields out the elements to protect and extend the life of the reel, the hose and the components inside. It adds a neat, tidy, aesthetic appearance to work environments that demand a clean and professional look. The 3 piece casing is easy to assemble and disassemble for simple installation and maintenance.

EN SERIES

Do not exceed listed hose O.D. to obtain maximum length.

HOSE							LESS HOSE		SIZE INDEX
MODEL	I.D.	O.D.	FT.	PSI	APRX. LBS.	EZ-COIL MODELS	MODEL	APRX. LBS.	
LOW PRESSURE Models with hose are for air water service with a maximum temperature 150°F. Models less hose can be used for air, water or oil.									
EN-N-125	1/4"	1/2"	25	300	51	-	ENL-N-125	48	1
EN-N-135	1/4"	1/2"	35	300	51	-	ENL-N-135	48	1
EN-N-150	1/4"	1/2"	50	300	52	-	ENL-N-150	47	1
EN-N-160	1/4"	1/2"	60	300	65	-	ENL-N-160	60	2
EN-N-325	3/8"	5/8"	25	300	49	EZ-EN-325	ENL-N-325	46	1
EN-N-335	3/8"	5/8"	35	300	50	-	ENL-N-335	46	1
EN-N-350	3/8"	5/8"	50	300	65	EZ-EN-350	ENL-N-350	58	2
EN-N-360	3/8"	5/8"	60	300	68	-	ENL-N-360	61	2
EN-N-425	1/2"	3/4"	25	300	63	EZ-EN-425	ENL-N-425	58	1
EN-N-435	1/2"	3/4"	35	300	64	-	ENL-N-435	59	2
EN-N-450	1/2"	3/4"	50	300	69	EZ-EN-450	ENL-N-450	64	2
MEDIUM PRESSURE Reels are furnished with standard one wire braid hose suitable for air, water or oil applications. Hose exceeds SAE R1 specifications. Maximum Temperature 250°F.									
ENM-N-325	3/8"	11/16"	25	3,000	61	EZ-ENM-325	ENML-N-325	54	1
ENM-N-335	3/8"	11/16"	35	3,000	64	-	ENML-N-335	55	1
ENM-N-350	3/8"	11/16"	50	3,000	80	EZ-ENM-350	ENML-N-350	68	2
ENM-N-425	1/2"	13/16"	25	2,500	61	EZ-ENM-425	ENML-N-425	54	1
ENM-N-435	1/2"	13/16"	35	2,500	76	-	ENML-N-435	66	2
ENM-N-450	1/2"	13/16"	50	2,500	82	EZ-ENM-450	ENML-N-450	68	2
HIGH PRESSURE Reels are furnished standard with S.A.E. 100R16 #1 or #2 wire braid hose suitable for grease and hydraulic oil applications. Maximum Temperature 250°F.									
ENH-N-125	1/4"	9/16"	25	5,000	60	EZ-ENH-125	ENHL-N-125	54	1
ENH-N-135	1/4"	9/16"	35	5,000	63	-	ENHL-N-135	55	1
ENH-N-150	1/4"	9/16"	50	5,000	79	EZ-ENH-150	ENHL-N-150	68	2
ENH-N-160	1/4"	9/16"	60	5,000	85	-	ENHL-N-160	71	2
ENH-N-325	3/8"	11/16"	25	4,000	61	-	ENHL-N-325	54	1
ENH-N-335	3/8"	11/16"	35	4,000	76	-	ENHL-N-335	67	2
ENH-N-350	3/8"	11/16"	50	4,000	80	EZ-ENH-350	ENHL-N-350	68	2

To order EZ-Coil® equipped models less hose, please add prefix "EZ-"

REEL DIMENSIONS

Technical Data Sheets Available On Website

SIZE INDEX	W	H	L	X	Y	M	N
1	67/8"	187/8"	19"	6"	6"	4"	5"
2	81/2"	213/4"	217/8"	6"	6"	4"	5"

Overall Dimensions Base Mounting Pattern

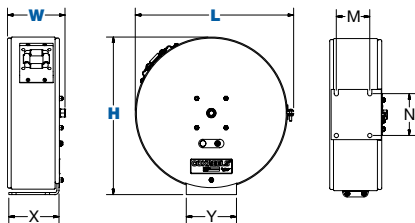

EN SERIES :: REEL SPECIFICATIONS

SWIVEL

- Machined from solid brass 90° full-flow NPT swivel inlet (Zinc plated steel swivel on HP models)
- Swivel Seals: NITRILE

DESIGN & STRUCTURE

- Sturdy enclosed reel for aesthetic purposes & greater hose protection
- Models with size index #2 feature Coxreels' exclusive Super Hub™ dual axle support system
- Solid one piece, heavy gauge 1/4" steel base & support post for maximum stability
- 1" solid steel axle & lubricated precision bearings for smooth rotation
- Heavy gauge steel 3-piece casing with adjustable hose roller guide

RETRACTION

- Controlled retraction speed up to 80% slower on EZ-COIL models :: See page 7 for details
- Enclosed factory tuned & matched cartridge-style spring motor
- Non corrosive stainless steel spring, pawl & zinc plated ratchet
- Multi-position lock ratchet mechanism secures hose at desired length

SIGNATURE FEATURES

- Professional grade heavy duty steel construction
- Durable proprietary CPC™ powder coat process
- Rolled edges & ribbed discs provide strength & safety
- Leading 2-year manufacturer's limited warranty
- Made in the U.S.A. - Sold & Supported Worldwide

POSSIBLE FIELDS OF APPLICATION

- Air/Water Services
- Pneumatic Tools
- Lubrication
- Chemical Fluid Transfer
- General Industrial
- Restaurants & Commercial Kitchens
- Grocery Stores
- Food & Chemical Plants

ACCESSORIZE YOUR REEL :: PG 56

- O-Rings & Swivels
- Mounting Brackets
- Hoses
- Assorted Reel Accessories

WARNING: Cancer and reproductive Harm – See page 66

1/4" - 1/2" I.D.

S & SG SERIES

SIDE MOUNT HOSE REELS FOR CABINET MOUNT & WITH GUIDE ARM



SG Series

S Series

Reel Orientation:
Right Mount is shown with
mounting base on the right
side & hose payout from
the top of the reel

S & SG SERIES :: REEL SPECIFICATIONS

SWIVEL

- External fluid path with machined from solid brass 90° full-flow NPT swivel inlet (Zinc plated steel swivel on HP models)
- Swivel Seals: NITRILE

DESIGN & STRUCTURE

- Side mount design for vertical flat surface, cabinet or enclosed space mounts
- 2-bolt mounting pattern easily mounts & detaches for temporary or permanent installation
- Solid one piece, heavy gauge steel arm base for maximum stability
- 1" solid steel axle & lubricated precision bearings for smooth rotation
- (On S Models only) Hose control bar prevents hose from slipping off the discs
- (On SG Models only) Adjustable 6 position guide arm & roller assembly provide maximum hose control

RETRACTION

- Controlled retraction speed up to 80% slower on EZ-COIL models :: See page 7 for details
- Enclosed factory tuned & matched cartridge-style spring motor
- Non corrosive stainless steel spring, pawl & zinc plated ratchet
- Multi-position lock ratchet mechanism secures hose at desired length.
- Non-locking, less ratchet option available (add suffix **-BXC**)

SIGNATURE FEATURES

- Professional grade heavy duty steel construction
- Durable proprietary CPC™ powder coat process
- Rolled edges & ribbed discs provide strength & safety
- Leading 2-year manufacturer's limited warranty
- Made in the U.S.A. - Sold & Supported Worldwide

POSSIBLE FIELDS OF APPLICATION

- Air/Water Services
- Pneumatic Tools
- Lubrication
- Service / Mechanic / Utility Vehicles
- Chemical Fluid Transfer
- General Industrial
- Cabinet Mount
- Construction Sites

ACCESSORIZE YOUR REEL :: pg 56

- O-Rings & Swivels
- Hoses
- Assorted Reel Accessories

WARNING: Cancer and reproductive Harm – See page 22

COXREELS® S Series "Side Mount" spring driven hose reels for cabinet mount & SG Series, that expand the capabilities of S Series adding a multi-position guide arm, are compact, versatile and unique in the way they mount and operate. They feature a simple two-bolt mounting pattern for easy installation and detachment for multiple workstation applications. Available standard for air/water, oil and grease hose. Common applications include tool boxes, vertical walls and beams, vehicle lift systems, machine tools, service vehicles or any flat vertical surface. Other hose style can be equipped on those reels. Consult factory.

S SERIES

*The table below only shows "Mount Right" models. To order "Mount Left" models replace "R" with "L".
EXAMPLE: Change the SR13-L125 to SL13-L125 Do not exceed listed hose O.D. to obtain maximum length.

HOSE						LESS HOSE		SIZE INDEX	
MODEL	I.D.	O.D.	FT.	PSI	APPR. LBS.	MODEL	APPR. LBS.		
LOW PRESSURE Models with hose are for air/water service with a maximum temperature 150°F. Models less hose can be used for air, water or oil.									
SR13-L125	1/4"	1/2"	25	300	18	EZ-SR13-L125	SR13L-L125	14	1
SR15-L135	1/4"	1/2"	35	300	23	EZ-SR15-L135	SR15L-L135	17	2
SR15-L325	3/8"	5/8"	25	300	23	EZ-SR15-L325	SR15L-L325	17	2
SR17-L350	3/8"	5/8"	50	300	32	EZ-SR17-L350	SR17L-L350	25	3
SR17-L430	1/2"	3/4"	30	300	34	EZ-SR17-L430	SR17L-L430	29	3
SR19-L450	1/2"	3/4"	50	300	37	-	SR19L-L450	29	5
MEDIUM PRESSURE Reels are furnished with standard one wire braid hose suitable for air, water or oil applications. Hose exceeds SAE R1 specifications. Maximum Temperature 250°F.									
SR17-M325	3/8"	5/8"	25	3,000	41	-	SR17L-H125	31	4
SR19-M350	3/8"	5/8"	50	3,000	48	-	SR19L-H150	36	5
SR17-M425	1/2"	3/4"	25	2,500	38	-	SR17L-H325	31	4
SR19-M450	1/2"	3/4"	50	2,500	50	-	SR19L-H350	36	6
HIGH PRESSURE Reels are furnished standard with S.A.E. 100R16 #1 or #2 wire braid hose suitable for grease and hydraulic oil applications. Maximum Temperature 250°F.									
SR17-H125	1/4"	1/2"	25	5,000	37	-	SR17L-H125	31	4
SR19-H150	1/4"	1/2"	50	5,000	47	-	SR19L-H150	36	6
SR17-H325	3/8"	5/8"	25	4,000	38	-	SR17L-H325	31	4
SR19-H350	3/8"	5/8"	50	4,000	48	-	SR19L-H350	36	7

To order EZ-Coil® equipped models less hose, please add prefix "EZ-"

SG SERIES

HOSE						LESS HOSE		SIZE INDEX	
MODEL	I.D.	O.D.	FT.	PSI	APPR. LBS.	MODEL	APPR. LBS.		
LOW PRESSURE Models with hose are for air/water service with a maximum temperature 150°F. Models less hose can be used for air, water or oil.									
SG13-L125	1/4"	1/2"	25	300	25	EZ-SG13-L125	SG13L-L125	22	8
SG13-L135	1/4"	1/2"	35	300	26	EZ-SG13-L135	SG13L-L135	23	8
SG13-L325	3/8"	5/8"	25	300	26	EZ-SG13-L325	SG13L-L325	23	9
SG17-L350	3/8"	5/8"	50	300	40	EZ-SG17-L350	SG17L-L350	33	10
SG17-L430	1/2"	3/4"	30	300	42	EZ-SG17-L430	SG17L-L430	37	10
SG19-L450	1/2"	3/4"	50	300	52	EZ-SG19-L450	SG19L-L450	44	12
MEDIUM PRESSURE Reels are furnished with standard one wire braid hose suitable for air, water or oil applications. Hose exceeds SAE R1 specifications. Maximum Temperature 250°F.									
SG17-M325	3/8"	11/16"	25	3,000	46	EZ-SG17-M325	SG17L-M325	39	10
SG19-M350	3/8"	11/16"	50	3,000	63	EZ-SG19-M350	SG19L-M350	51	12
SG17-M425	1/2"	13/16"	25	2,500	46	EZ-SG17-M425	SG17L-M425	39	11
SG19-M450	1/2"	13/16"	50	2,500	65	EZ-SG19-M450	SG19L-M450	51	13
HIGH PRESSURE Reels are furnished standard with S.A.E. 100R16 #1 or #2 wire braid hose suitable for grease and hydraulic oil applications. Maximum Temperature 250°F.									
SG17-H125	1/4"	9/16"	25	5,000	45	EZ-SG17-H125	SG17L-H125	39	11
SG19-H150	1/4"	9/16"	50	5,000	62	EZ-SG19-H150	SG19L-H150	51	14
SG17-H325	3/8"	11/16"	25	4,000	46	EZ-SG17-H325	SG17L-H325	39	11
SG19-H350	3/8"	11/16"	50	4,000	63	EZ-SG19-H350	SG19L-H350	51	15

To order EZ-Coil® equipped models less hose, please add prefix "EZ-"

REEL DIMENSIONS

Technical Data Sheets Available On Website

SIZE INDEX	W	H	L	Y	M
1	6"	14 1/4"	13"	2 1/2"	9 1/4"
2	6"	16 1/2"	15 1/4"	2 1/2"	10 1/4"
3	5 3/4"	18 1/4"	17"	2 1/2"	13"
4	6 5/8"	18 1/4"	17"	2 1/2"	13"
5	7 1/2"	20 3/4"	19 1/2"	2 1/2"	14 1/4"
6	8"	20 3/4"	19 1/2"	2 1/2"	14 1/4"
7	8 1/2"	20 3/4"	19 1/2"	2 1/2"	14 1/4"
8	6 1/4"	15 1/2"	13 1/2"	2 1/2"	14"
9	6 3/4"	15 1/2"	13 1/2"	2 1/2"	14"
10	6 3/4"	19 1/2"	17"	2 1/2"	18"
11	7 1/4"	19 1/2"	17"	2 1/2"	18"
12	8 1/2"	22"	19 1/2"	2 7/8"	20 1/2"
13	9 3/8"	22"	19 1/2"	2 7/8"	20 1/2"
14	9"	22"	19 1/2"	2 7/8"	20 1/2"
15	9 1/2"	22"	19 1/2"	2 7/8"	20 1/2"

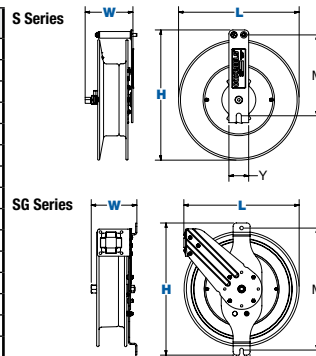

COXREELS® SP Series "Single Product Delivery" spring driven hose reels are built to handle large hose diameters. Used in applications demanding large volume delivery in low and medium pressures such as fuel and water. The sturdy box-style frame has heavy duty steel cross supports to all four corners for extra strength and rigidity.

SP SERIES

Do not exceed listed hose O.D. to obtain maximum length.

HOSE							LESS HOSE		SIZE INDEX
MODEL	I.D.	O.D.	FT.	PSI	INLET/OUTLET N.P.T.	APRX. LBS.	MODEL	APRX. LBS.	
LOW PRESSURE Dual braid hose for applications 250 to 300 psi and temperatures to 150° F. Reel less hose 250° F. For higher temperatures and pressures, see price sheet or consult factory.									
SLP-4100	1/2"	3/4"	100	300	1/2"	111	SLPL-4100	96	1
SLP-550	3/4"	1 1/16"	50	300	3/4"	99	SLPL-550	86	2
SLP-575	3/4"	1 1/16"	75	300	3/4"	136	SLPL-575	117	3
SLP-5100	3/4"	1 1/16"	100	300	3/4"	151	SLPL-5100	126	3
SLP-625	1"	1 1/2"	25	300	1"	106	SLPL-625	90	4
SLP-650	1"	1 1/2"	50	300	1"	139	SLPL-650	109	5
SLP-675	1"	1 1/2"	75	300	1"	193	SLPL-675	148	6
Please consult factory for reels with hose	1 1/4"	1 13/16"	25	250	1 1/2"***	-	SLPL-725	110	7
	1 1/4"	1 13/16"	50	250	1 1/2"***	-	SLPL-750	123	8
	1 1/2"	2 1/16"	25	250	1 1/2"	-	SLPL-825	107	7
	1 1/2"	2 1/16"	35	250	1 1/2"	-	SLPL-835	128	8
	1 1/2"	2 1/16"	50	250	1 1/2"	-	SLPL-850	138	9
MEDIUM PRESSURE Steel reinforced 100 RI hose for applications 1500 to 2500 psi and temperatures to 250° F. For higher temperatures and pressures, see price sheet or consult factory.									
SMP-4100	1/2"	1 3/16"	100	2,500	1/2"	139	SMPL-4100	113	1
SMP-550	3/4"	1 1/16"	50	1,500	3/4"	109	SMPL-550	89	2
SMP-575	3/4"	1 1/16"	75	1,500	3/4"	151	SMPL-575	121	3
SMP-5100	3/4"	1 1/16"	100	1,500	3/4"	165	SMPL-5100	126	3
Please consult factory for reels with hose	1"	1 3/8"	25	2,000	1"	-	SMPL-625	92	4
	1"	1 3/8"	50	2,000	1"	-	SMPL-650	110	5
	1"	1 3/8"	75	2,000	1"	-	SMPL-675	135	6

** Reducer #1578 is required for 1-1/4" hose. Not supplied with reel, see page 52

REEL DIMENSIONS

Technical Data Sheets Available On Website

SIZE INDEX	W	H	L	X	Y	Ø	Dw
1	18 1/2"	20 1/2"	22 7/8"	15 3/8"	21 1/2"	10 1/2"	7 1/2"
2	19 5/8"	20 1/2"	22 7/8"	15 3/8"	21 1/2"	10 1/2"	7 1/2"
3	19 5/8"	24 1/2"	26 3/8"	15 3/8"	25"	10 1/2"	7 1/2"
4	21"	20 1/2"	22 7/8"	15 3/8"	21 1/2"	10 1/2"	7 1/2"
5	21"	24 1/2"	26 3/8"	15 3/8"	25"	10 1/2"	7 1/2"
6	21"	28 1/2"	30 3/8"	15 3/8"	29"	10 1/2"	7 1/2"
7	17 1/2"	24 1/2"	26 3/8"	15 3/8"	25"	10 1/2"	7 1/2"
8	18"	28 1/2"	30 3/8"	15 3/8"	29"	10 1/2"	7 1/2"
9	20"	28 1/2"	30 3/8"	17 3/8"	29"	10 1/2"	9 1/2"

Overall Dimensions Base Drum

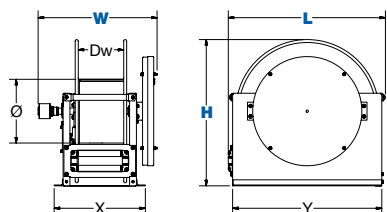

SP SERIES :: REEL SPECIFICATIONS

SWIVEL

- Machined from solid brass 90° full-flow NPT swivel inlets
- Electroless nickel plated steel 90° swivel on 1" models
- External fluid path with in-line electroless nickel plated steel full-flow NPT swivel on 1 1/4" and 1 1/2" models
- Swivel Seals: NITRILE (AFLAS on 1" models)
- Optional stainless steel in-line and 90° swivel for 1 1/4" and 1 1/2" models

DESIGN & STRUCTURE

- Reel features a sturdy box-style frame design
- Reel adjusts to wall, floor, vehicle & overhead positions
- Heavy gauge 1/4" steel base for maximum strength
- Reinforced steel frame provides maximum strength & stability
- Long lasting self-lubricated flange bearings for smooth rotation
- Heavy duty 1" stainless steel pinch-proof rollers

RETRACTION

- Enclosed factory tuned & matched cartridge-style spring motor
- Non corrosive stainless steel pawl spring
- Cast iron lock ring with non-sparking bronze pawl
- Multi-position lock ratchet mechanism secures hose at desired length

SIGNATURE FEATURES

- Professional grade heavy duty steel construction
- Durable proprietary CPC™ powder coat process
- Rolled edges & ribbed discs provide strength & safety
- Leading 2-year manufacturer's limited warranty
- Made in the U.S.A. - Sold & Supported Worldwide

POSSIBLE FIELDS OF APPLICATION

- General Industrial
- Bulk Handling
- Lubrication
- Fuel Delivery
- Chemical Fluid Transfer
- Service / Mechanic / Utility Vehicles
- Lube Skids & Trucks
- Mining, Construction & Railroad Operations
- Aircraft & Fleet Maintenance
- Marine, Offshore & Ship Building

ACCESSORIZE YOUR REEL :: PG 56

- O-Rings & Swivels
- Hoses
- Assorted Reel Accessories

WARNING: Cancer and reproductive Harm – See page 56

3/8" - 3/4" I.D.

DP SERIES

DUAL HIGH CAPACITY HOSE REELS

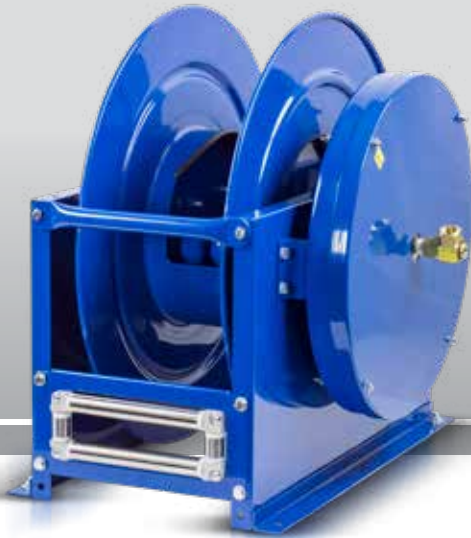

COXREELS® DP Series “Dual Product Delivery” spring driven hose reels have two swivel inlets and two outlets for dual hose applications. Like the SP Series they are built to handle large hose diameters used in applications demanding large volume delivery in low and medium pressures. The sturdy box-style frame has heavy duty steel cross supports to all four corners for extra strength and rigidity.

DP SERIES

Do not exceed listed hose O.D. to obtain maximum length.

HOSE							LESS HOSE		SIZE INDEX
MODEL	I.D.	O.D.	FT.	PSI	INLET/OUTLET N.P.T.	APRX. LBS.	MODEL	APRX. LBS.	
LOW PRESSURE							Two swivel joint inlets and two outlet risers to handle equal lengths of two hoses. Hoses can be different diameters, For applications 300 PSI and temperatures to 250° F.		
Please consult factory for reels with hose	3/8"	3/4"	50	300	1/2"	-	DLPL-350	94	1
	3/8"	3/4"	75	300	1/2"	-	DLPL-375	115	1
	3/8"	3/4"	100	300	1/2"	-	DLPL-3100	117	2
	1/2"	7/8"	50	300	1/2"	-	DLPL-450	97	1
	1/2"	7/8"	75	300	1/2"	-	DLPL-475	104	2
	1/2"	7/8"	100	300	1/2"	-	DLPL-4100	138	3
	3/4"	1 1/4"	25	300	3/4"	-	DLPL-525	93	4
3/4"	1 1/4"	50	300	3/4"	-	DLPL-550	100	5	
MEDIUM PRESSURE							Two swivel joint inlets and two outlet risers to handle equal lengths of two hoses. Hoses can be different diameters. For applications 3,000 PSI and temperatures to 250° F. For higher temperatures and pressures consult factory.		
Please consult factory for reels with hose	3/8"	1 3/16"	50	3,000	1/2"	-	DMPL-350	99	1
	3/8"	1 3/16"	75	3,000	1/2"	-	DMPL-375	128	1
	3/8"	1 3/16"	100	3,000	1/2"	-	DMPL-3100	120	2
	1/2"	1 5/16"	50	3,000	1/2"	-	DMPL-450	102	1
	1/2"	1 5/16"	75	3,000	1/2"	-	DMPL-475	115	2
	1/2"	1 5/16"	100	3,000	1/2"	-	DMPL-4100	138	3

DP SERIES :: REEL SPECIFICATIONS

SWIVEL

- Two external fluid paths with machined from solid brass 90° full-flow NPT swivel inlets
- Swivel Seals: NITRILE

DESIGN & STRUCTURE

- Sturdy box-style frame design with two inlets & two outlets to handle dual hose applications
- Low profile outlet riser & open drum slot design for even hose wrap
- Reel adjusts to wall, floor, vehicle & overhead positions with optional roller bracket
- Heavy gauge 1/4" steel base for maximum strength
- Reinforced steel frame provides maximum strength & stability
- Long lasting self-lubricated flange bearings for smooth rotation
- Heavy duty 1" stainless steel pinch-proof rollers

RETRACTION

- Enclosed factory tuned & matched cartridge-style spring motor
- Non corrosive stainless steel pawl spring
- Cast iron lock ring with non-sparking bronze pawl
- Multi-position lock ratchet mechanism secures hose at desired length

SIGNATURE FEATURES

- Professional grade heavy duty steel construction
- Durable proprietary CPC™ powder coat process
- Rolled edges & ribbed discs provide strength & safety
- Leading 2-year manufacturer's limited warranty
- Made in the U.S.A. - Sold & Supported Worldwide

POSSIBLE FIELDS OF APPLICATION

- Hydraulics
- Twin Agent Applications
- Hydrant Dispenser
- Chemical Fluid Transfer

ACCESSORIZE YOUR REEL :: PG 56

- O-Rings & Swivels
- Hoses
- Roller Brackets
- Assorted Reel Accessories

REEL DIMENSIONS

Technical Data Sheets Available On Website

SIZE INDEX	W	H	L	X	Y	Ø	Dw
1	21 1/2"	20 1/2"	22 7/8"	15 3/8"	21 1/2"	10 1/2"	7 1/2"
2	21 1/2"	24 1/2"	26 3/8"	15 3/8"	25"	10 1/2"	7 1/2"
3	21 1/2"	28 1/2"	30 3/8"	15 3/8"	29"	10 1/2"	7 1/2"
4	23 7/8"	20 1/2"	22 7/8"	15 3/8"	21 1/2"	10 1/2"	7 1/2"
5	23 7/8"	24 1/2"	26 3/8"	15 3/8"	25"	10 1/2"	7 1/2"

Overall Dimensions Base Drum

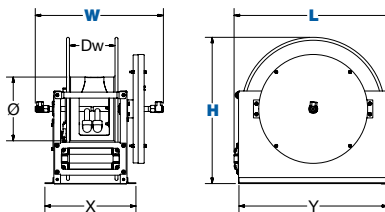

COXREELS® ACCESSORY



Top Rewind 4-Way Roller Bracket for SP & DP Series FOR CEILING, WALL OR FLOOR MOUNT APPLICATIONS

4-way enclosed pinch-proof stainless steel rollers are 1" in diameter supported by powder coated steel brackets. Specify ceiling mount & specify drum width. Weight: 10 lbs.

For 3/8" - 3/4" - **20458 & 8100** For 1" - 1 1/2" - **20458 & 8101**

WARNING: Cancer and reproductive Harm – See page 22 of MSDS

3/8" I.D.
12GA - 16GA

C SERIES

DUAL PURPOSE HOSE REELS - AIR/ELECTRIC



COXREELS® C Series "Combination" spring driven air hose/electric cord reels are two reels in one compact assembly. They are perfect for applications that require pneumatic air and an electrical power feed. The single expanded mounting base creates stability and adds to the convenience of one mounting pattern. This series is also available in dual hose combinations.

C SERIES :: REEL SPECIFICATIONS

UL Listed† :: Accessories only

SWIVEL & LEAD CABLE

- External fluid path with machined from solid brass 90° full-flow NPT swivel inlet
- Swivel Seals: NITRILE
- External CPC™ powder coated steel components cover for simple slip ring routine maintenance
- Include 5' lead cable & grounding plug (except on less cord models)
- (On -4 Models only) Include 5' lead cable & flying lead

DESIGN & STRUCTURE

- Compact two reel assembly for air/electric applications, each reel operates independently
- Guide arm adjusts to wall, floor & overhead positions
- Single expanded, 1/4" steel mounting base for increased stability & space efficiency
- One mounting pattern allow 1/2 the installation time required to install 2 reels at one station
- 1" solid steel axle & lubricated precision bearings for smooth rotation

RETRACTION

- Enclosed factory tuned & matched cartridge-style spring motor
- Non corrosive stainless steel spring, pawl & zinc plated ratchet
- Multi-position lock ratchet mechanism secures hose/cord at desired length

SIGNATURE FEATURES

- Professional grade heavy duty steel construction
- Durable proprietary CPC™ powder coat process
- Rolled edges & ribbed discs provide strength & safety
- Leading 2-year manufacturer's limited warranty
- Made in the U.S.A. - Sold & Supported Worldwide

POSSIBLE FIELDS OF APPLICATION

- Air Services
- Pneumatic Tools
- Power Tools
- Light Source
- Manufacturing Plants & Facilities
- Maintenance, Repair & Operations
- Automotive & Fleet Service Centers
- General Industrial

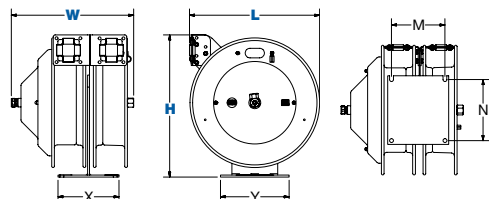

WARNING: Cancer and reproductive Harm – See page 22

C SERIES

Do not exceed listed hose O.D. to obtain maximum length.



Receptacle End



Plug End

		HOSE & CORD										SIZE INDEX
MODEL	ACCESSORY	INLET OUTLET	AWG / NO COND.	CORD FT.	TYPE	AMPS.	I.D.	O.D.	FT.	PSI	APPR. LBS.	
FOR INDOOR USE ONLY!												
Coxreels electric and pneumatic hose reels operate as two independent, self-retracting 50 foot trouble-free assemblies. All Models rated: 115 volts, 3" conductors, 60hz single phase.												
C-L350-5016-A	Single Industrial Receptacle†		16 / 3	50	SJO	13	3/8"	5/8"	50	300	79	1
C-L350-5012-A	Single Industrial Receptacle†		12 / 3	50	SJO	20	3/8"	5/8"	50	300	84	1
C-L350-5012-B	Quad "4 Plug" Industrial Receptacle†		12 / 3	50	SJO	20	3/8"	5/8"	50	300	85	1
C-L350-5016-F	Duplex G.F.C.I. Metal Industrial Receptacle†		16 / 3	50	SJO	13	3/8"	5/8"	50	300	79	1
C-L350-5012-F			12 / 3	50	SJO	20	3/8"	5/8"	50	300	84	1
C-L350-5016-E	Caged Drop Light with Tool Tap Plug†		16 / 3	50	SJTO	13	3/8"	5/8"	50	300	79	1
C-L350-5016-H	Industrial Duty LED Light†		16 / 3	50	SJTO	.17	3/8"	5/8"	50	300	79	1
C-L350-5016-K	Super-Bright LED Light with Tool Tap on Handle		16 / 3	50	SJTO	13	3/8"	5/8"	50	300	79	1
C-L350-5016-M	Compact Super-Bright LED Light		16 / 3	50	SJTO	.17	3/8"	5/8"	50	300	79	1
C-L350-5016-X	With Hose, With Cord, Less Accessory		16 / 3	50	SJO	13	3/8"	5/8"	50	300	78	1
C-L350-5012-X			12 / 3	50	SJO	20	3/8"	5/8"	50	300	83	1
C-L350-5012-4	With Hose, With Cord, Less Accessory		12 / 4	50	SJO	13	3/8"	5/8"	50	300	86	
C-L350L-5016L-X	Less Hose, Less Cord, Less Accessory		16 / 3	50	N/A	25	3/8"	5/8"	50	300	71	1
C-L350L-5012L-X			12 / 3	50	N/A	25	3/8"	5/8"	50	300	71	1

REEL DIMENSIONS

Technical Data Sheets Available On Website

SIZE INDEX	W	H	L	X	Y	M	N
1	16"	18 5/8"	17"	8"	9"	7"	8"



END USER CAUTION STATEMENTS

- Cord AWG, length, insulation rating, as well as single or multi-phase electrical service must be considered in determining the power rating for each reel. End use application must not exceed the lowest rated component (reel or cord). End user is responsible for determining and ensuring compliance to national and local codes as required.
- Disconnect power source from reel while unspooling / spooling cord.
- Cord should be completely unspooled from the reel when energized. Otherwise follow NEC ampacity derating factors in 310.15(B)(3)(a) where "# current carrying conductors in the service cord" X "#cord layers on the reel" = "# current carrying conductors" in a raceway. Apply the appropriate derating factor to the cord ampacity listed in 310.15(B)(16).

10GA - 16GA

PC SERIES

POWER CORD REELS



PC24-0012-B

EZ-PC13-5016-A

PC SERIES :: REEL SPECIFICATIONS

SLIP RING

- External heavy gauge CPC™ powder coated steel components cover for simple slip ring routine maintenance
- Electrical current runs through a 25AMP / 300V rated slip ring (30AMP / 600V on select models)
- Include 5' lead cable & grounding plug (except on less cord models)
- (On -4 & PC17 Models only) Include 5' lead cable & flying lead

DESIGN & STRUCTURE

- Single pedestal cord reel with space saving design facilitates workplace organization
- Guide arm adjusts to wall, floor & overhead positions
- Solid one piece, heavy gauge 1/4" steel base & support post for maximum stability
- Coxreels' exclusive Super Hub™ dual axle support system on models with size index #3 & #4
- 1" solid steel axle & lubricated precision bearings for smooth rotation

RETRACTION

- Controlled retraction speed up to 80% slower on EZ-COIL models :: See page 7 for details
- Enclosed factory tuned & matched cartridge-style spring motor
- Non-corrosive stainless steel spring, pawl & zinc plated ratchet
- Multi-position lock ratchet mechanism secures cord at desired length

SIGNATURE FEATURES

- Professional grade heavy duty steel construction
- Durable proprietary CPC™ powder coat process
- Rolled edges & ribbed discs provide strength & safety
- Leading 2-year manufacturer's limited warranty
- Made in the U.S.A. - Sold & Supported Worldwide

POSSIBLE FIELDS OF APPLICATION

- Power Tools
- Light Source
- General Industrial
- Manufacturing Plants
- Automotive & Fleet Service Centers
- Construction Sites
- Workshops

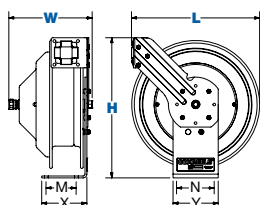

WARNING: Cancer and reproductive Harm – See page 22

PC SERIES



		CORD							EZ-COIL MODELS	SIZE INDEX
MODEL	ACCESSORY	INLET / NO. OUTLET	AWG / NO. COND.	CORD FT.	TYPE	VOLTS	AMPS	APPR. LBS.		
FOR INDOOR USE ONLY! All models rated at 115 volts, 60 hz single phase only.										
PC13-3516-A†	Single Industrial Receptacle†	⊕	16 / 3	35	SJO	115	13	34	-	1
PC13-5016-A†		⊕	16 / 3	50	SJO	115	13	36	EZ-PC13-5016-A	1
PC19-7516-A†		⊕	16 / 3	75	SJO	115	13	60	-	3
PC24-0016-A†		⊕	16 / 3	100	SJO	115	13	73	EZ-PC24-0016-A	4
PC13-3512-A†	Single Industrial Receptacle†	⊕	12 / 3	35	SJO	115	20	37	-	1
PC13-5012-A†		⊕	12 / 3	50	SJO	115	20	40	EZ-PC13-5012-A	1
PC19-7512-A†		⊕	12 / 3	75	SJO	115	20	67	-	3
PC24-0012-A†		⊕	12 / 3	100	SJO	115	20	81	EZ-PC24-0012-A	4
PC13-3512-B†	Quad "4 Plug" Industrial Receptacle†	⊕	12 / 3	35	SJO	115	20	38	-	1
PC13-5012-B†		⊕	12 / 3	50	SJO	115	20	41	EZ-PC13-5012-B	1
PC19-7512-B†		⊕	12 / 3	75	SJO	115	20	68	-	3
PC24-0012-B†		⊕	12 / 3	100	SJO	115	20	84	EZ-PC24-0012-B	4
PC13-3516-F†	Duplex G.F.C.I. Metal Industrial Receptacle†	⊕	16 / 3	35	SJO	115	13	36	-	1
PC13-5016-F†		⊕	16 / 3	50	SJO	115	13	38	EZ-PC13-5016-F	1
PC19-7516-F†		⊕	16 / 3	75	SJO	115	13	60	-	3
PC24-0016-F†		⊕	16 / 3	100	SJO	115	13	73	EZ-PC24-0016-F	4
PC13-3512-F†		⊕	12 / 3	35	SJO	115	20	39	-	1
PC13-5012-F†		⊕	12 / 3	50	SJO	115	20	42	EZ-PC13-5012-F	1
PC19-7512-F†		⊕	12 / 3	75	SJO	115	20	67	-	3
PC24-0012-F†		⊕	12 / 3	100	SJO	115	20	83	EZ-PC24-0012-F	4
PC19-7516-X	With Cord, Less Accessory	⊕	16 / 3	75**	SJO	115	13	60	-	3
PC24-0016-X		⊕	16 / 3	100**	SJO	115	13	71	EZ-PC24-0016-X	4
PC13-5012-X††		⊕	12 / 3	50**	SJO	115	20	40	EZ-PC13-5012-X	1
PC19-7512-X††		⊕	12 / 3	75**	SJO	115	20	66	-	3
PC24-0012-X		⊕	12 / 3	100**	SJO	115	20	81	EZ-PC24-0012-X	4
PC17-3510-X††		⊕	10 / 3	35**	SO	115	30	62	-	2
PC17-5010-X††		⊕	10 / 3	50**	SO	115	30	67	-	2
PC13-3516-4	With Cord, Less Accessory	⊕	16 / 4	35	SJO	115	10	34	-	1
PC13-5016-4		⊕	16 / 4	50	SJO	115	10	36	-	1
PC24-0016-4		⊕	16 / 4	100	SJO	115	10	74	-	4
PC13-3512-4		⊕	12 / 4	35	SJO	115	20	31	-	1
PC13-5012-4		⊕	12 / 4	50	SJO	115	20	40	EZ-PC13-5012-4	1
PC24-0012-4		⊕	12 / 4	100	SJO	115	20	85	-	4
PC13L-5016††	Less Cord, Less Accessory		16 / 3	50*	SJO	115	25	31	EZ-PC13L-5016	1
PC19L-7516			16 / 3	75	SJO	115	25	52	-	3
PC24L-0016			16 / 3	100	SJO	115	25	62	EZ-PC24L-0016	4
PC13L-5012††			12 / 3	50	SJO	115	25	29	EZ-PC13L-5012	1
PC19L-7512			12 / 3	75	SJO	115	25	53	-	3
PC24L-0012			12 / 3	100	SJO	115	25	64	EZ-PC24L-0012	4
PC17L-5010††			10 / 3	-	-	115	30	49	-	2
PC13L-5016-4	Less Cord, Less Accessory		16 / 4	50	SJO	115	25	31	-	1
PC24L-0016-4			16 / 4	100	SJO	115	25	62	-	4
PC13L-5012-4			12 / 4	50	SJO	115	25	29	-	1
PC24L-0012-4			12 / 4	100	SJO	115	25	64	-	4

**When not using specified cord type capacity may vary.

REEL DIMENSIONS

Technical Data Sheets Available On Website

SIZE INDEX	W	H	L	X	Y	M	N
1	8 1/2"	14 7/8"	13 1/2"	5"	6"	3"	5"
2	11"	18 5/8"	17"	6"	6"	4"	5"
3	10 1/8"	21"	19 1/2"	6"	6"	4"	5"
4	10 1/4"	25 1/2"	24"	6"	6"	4"	5"

Overall Dimensions Base Mounting Pattern

END USER CAUTION STATEMENTS

- Cord AWG, length, insulation rating, as well as single or multi-phase electrical service must be considered in determining the power rating for each reel. End use application must not exceed the lowest rated component (reel or cord). End user is responsible for determining and ensuring compliance to national and local codes as required.
- Disconnect power source from reel while unspooling / spooling cord.
- Cord should be completely unspooled from the reel when energized. Otherwise follow NEC ampacity derating factors in 310.15(B)(3)(a) where "# current carrying conductors in the service cord" X "#cord layers on the reel" = "# current carrying conductors" in a raceway. Apply the appropriate derating factor to the cord ampacity listed in 310.15(B)(16).

POWER LIGHT REELS **PC SERIES**

10GA - 16GA

COXREELS® PC Series spring driven "Power Cord" reels are heavy duty, industrial grade power sources. They replace tangled extension cords and self-retract to increase safety, productivity and efficiency. Modeled after the P and SH Series, the PC Series are designed for long-lasting, trouble-free performance even under the most demanding conditions.

PC SERIES

		CORD							SIZE INDEX	
MODEL	ACCESSORY	INLET OUTLET	AWG / NO COND.	CORD FT.	TYPE	VOLTS	AMPS	APRX. LBS.	EZ-COIL MODELS	
FOR INDOOR USE ONLY! All models rated at 115 volts, 60 hz single phase only.										
PC13-3516-E†	Caged Drop Light with Tool Tap Plug	⊕	16 / 3	35	SJTO	115	13	34	-	1
PC13-5016-E†		⊕	16 / 3	50	SJTO	115	13	36	EZ-PC13-5016-E	1
PC19-7516-E†			16 / 3	75	SJTO	115	13	60	-	2
PC24-0016-E†			⊕	16 / 3	100	SJTO	115	13	73	EZ-PC24-0016-E
PC13-3516-H†	Industrial Duty LED Light†	⊕	16 / 3	35	SJTO	115	.17	35	-	1
PC13-5016-H†			16 / 3	50	SJTO	115	.17	37	EZ-PC13-5016-H	1
PC24-0016-H			⊕	16 / 3	100	SJTO	115	.17	70	EZ-PC24-0016-H
PC13-3516-K	Super-Bright LED Light with Tool Tap on Handle	⊕	16 / 3	35	SJTO	115	.17	35	-	1
PC13-5016-K		⊕	16 / 3	50	SJTO	115	.17	37	EZ-PC13-5016-K	1
PC13-3516-M			Compact Super-Bright LED Light	⊕	16 / 3	35	SJTO	115	.17	35
PC13-5016-M		⊕	16 / 3		50	SJTO	115	.17	37	EZ-PC13-5016-M



UL Listed †
NRTL Listed ††

PC SERIES :: REEL SPECIFICATIONS

SLIP RING

- External heavy gauge CPC™ powder coated steel components cover for simple slip ring routine maintenance
- Electrical current runs through a 25AMP / 300V rated slip ring (30AMP / 600V on select models)
- Include 5' lead cable & grounding plug (except on less cord models)

DESIGN & STRUCTURE

- Single pedestal cord reel with space saving design facilitates workplace organization
- Guide arm adjusts to wall, floor & overhead positions
- Solid one piece, heavy gauge 1/4" steel base & support post for maximum stability
- Coxreels' exclusive Super Hub™ dual axle support system on models with size index #3 & #4
- 1" solid steel axle & lubricated precision bearings for smooth rotation

RETRACTION

- Controlled retraction speed up to 80% slower on EZ-COIL models :: See page 7 for details
- Enclosed factory tuned & matched cartridge-style spring motor
- Non-corrosive stainless steel spring, pawl & zinc plated ratchet
- Multi-position lock ratchet mechanism secures cord at desired length

SIGNATURE FEATURES

- Professional grade heavy duty steel construction
- Durable proprietary CPC™ powder coat process
- Rolled edges & ribbed discs provide strength & safety
- Leading 2-year manufacturer's limited warranty
- Made in the U.S.A. - Sold & Supported Worldwide

POSSIBLE FIELDS OF APPLICATION

- Power Tools
- Light Source
- General Industrial
- Manufacturing Plants
- Automotive & Fleet Service Centers
- Construction Sites
- Workshops

ACCESSORIZE YOUR REEL :: PG 56

- Mounting Brackets
- Assorted Reel Accessories

REEL DIMENSIONS

Technical Data Sheets Available On Website

SIZE INDEX	W	H	L	X	Y	M	N
1	8 1/2"	14 7/8"	13 1/2"	5"	6"	3"	5"
2	10 1/8"	21"	19 1/2"	6"	6"	4"	5"
3	10 1/4"	25 1/2"	24"	6"	6"	4"	5"

Overall Dimensions Base Mounting Pattern

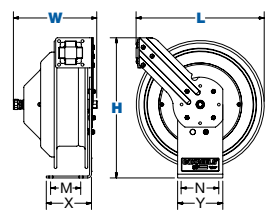

SPRING DRIVEN

EZ-COIL®

WARNING: Cancer and reproductive Harm – See page 56

1/4" I.D.

P-W & SHW SERIES SPRING DRIVEN WELDING HOSE REELS



COXREELS® P-W and SHW Series spring driven "Welding" hose reels are the ideal solution for managing bulky twin line welding hose. The P-W Series, like the P Series, is more compact in size and shares the reputation for long lasting performance. The SHW Series has a larger chassis and frame to accommodate longer lengths of welding hose and Coxreels' original Super Hub dual axle support system for increased stability during operation, less vibration and greater structural integrity.

P-W & SHW SERIES

Do not exceed listed hose O.D. to obtain maximum length.

HOSE						LESS HOSE		SIZE INDEX
MODEL	I.D.	FT.	PSI	APRX. LBS.	EZ-COIL MODELS	MODEL	APRX. LBS.	
OXYGEN-ACETYLENE								
Hose supplied on reel is twin-siamese type meeting R.M.A. and C.G.A. type V.D. grade R specifications. Use of other types of hose is not recommended.								
P-W-125	1/4"	25	200	46	EZ-P-W-125	P-WL-125†	39	1
P-W-135	1/4"	35	200	48	-	P-WL-135†	40	1
P-W-140	1/4"	40	200	51	-	P-WL-140†	42	1
SHW-N-150	1/4"	50	200	64	EZ-SHW-150	SHWL-N-150†	52	2
SHW-N-160	1/4"	60	200	76	-	SHWL-N-160†	61	3
SHW-N-175	1/4"	75	200	80	EZ-SHW-175	SHWL-N-175†	63	3
SHW-N-1100	1/4"	100	200	84	EZ-SHW-1100	SHWL-N-1100	62	3
OTHER FUELS								
Hose supplied on reel is twin-siamese type grade "T." Grade "T" reels and hoses are used for a wide variety of gases, such as MAPP, propane, natural and fuel.								
P-WT-125	1/4"	25	200	46	EZ-P-WT-125	P-WTL-125†	39	1
SHWT-N-150	1/4"	50	200	64	EZ-SHWT-150	SHWTL-N-150†	52	2
SHWT-N-175	1/4"	75	200	80	EZ-SHWT-175	SHWTL-N-175†	63	3
SHWT-N-1100	1/4"	100	200	84	EZ-SHWT-1100	SHWTL-N-1100	62	3

To order EZ-Coil® equipped models less hose, please add prefix "EZ-". Less hose models comes with inlet hose

P-W & SHW SERIES :: REEL SPECIFICATIONS

SWIVEL

- External fluid path with 90° full-flow dual ported brass swivel offering both connections from the same side of the reel
- Swivel lock bracket ensures maximum safety
- Swivel Seals: VITON®

DESIGN & STRUCTURE

- Designed for Oxy-Acetylene or "T" grade welding hose
- Single pedestal reel with space saving design facilitates workplace organization
- Guide arm adjusts to wall, floor & overhead positions
- Solid one piece, heavy gauge 1/4" steel base & support post for maximum stability
- 1" solid steel axle & lubricated precision bearings for smooth rotation
- Coxreels' exclusive Super Hub™ dual axle support system on models with size index #2 & #3

RETRACTION

- Controlled retraction speed up to 80% slower on EZ-COIL models :: See page 7 for details
- Enclosed factory tuned & matched cartridge-style spring motor
- Non corrosive stainless steel spring, pawl & zinc plated ratchet
- Multi-position non-sparking lock ratchet mechanism secures hose at desired length

SIGNATURE FEATURES

- Professional grade heavy duty steel construction
- Durable proprietary CPC™ powder coat process
- Rolled edges & ribbed discs provide strength & safety
- Leading 2-year manufacturer's limited warranty
- Made in the U.S.A. - Sold & Supported Worldwide

POSSIBLE FIELDS OF APPLICATION

- Manufacturing Plants
- Maintenance, Repair & Operations
- Welding / Service Trucks
- Welding Shops
- Garage Settings
- Automotive & Fleet Maintenance
- Pipelines
- Mining, Construction & Railroad Operations

ACCESSORIZE YOUR REEL :: PG 56

- O-Rings & Swivels
- Mounting Brackets
- Hoses
- Assorted Reel Accessories

REEL DIMENSIONS Technical Data Sheets Available On Website

SIZE INDEX	W	H	L	X	Y	M	N
1	8 1/2"	18 5/8"	17"	6"	6"	4"	5"
2	10 1/4"	21 1/4"	19 1/2"	6"	6"	4"	5"
3	10 1/4"	25 1/2"	24"	6"	6"	4"	5"

Overall Dimensions

Base

Mounting Pattern

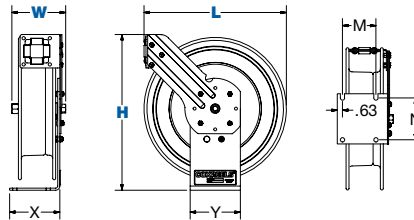

 WARNING: Cancer and reproductive Harm – See page 22 for details.

SIDE MOUNT WELDING HOSE REELS FOR CABINET MOUNT & WITH GUIDE ARM

SW & SGW SERIES

1/4" I.D.

COXREELS® SW Series "Side Mount" spring driven welding hose reels for cabinet mount & SGW Series spring driven welding hose reels with a multi-position guide arm, are compact, versatile and unique in the way they mount and operate. Ideal for tight spaces, the versatile SW Series and SGW Series, for oxy-acetylene and T Grade gas welding hose, feature a simple two-bolt mounting pattern for easy installation and detachment on any vertical flat surface. Common applications include service vehicles, tool benches, vertical walls and beams, vehicle lift systems, machine tools and more.

SW SERIES

*The table below only shows "Mount Right" models. To order "Mount Left" models replace "R" with "L".
EXAMPLE: Change the SR17W-150 to SL17W-150 Do not exceed listed hose O.D. to obtain maximum length.

HOSE					LESS HOSE		SIZE INDEX
MODEL	I.D.	FT.	PSI	APRX. LBS.	MODEL	APRX. LBS.	
OXYGEN-ACETYLENE Oxy-Acetylene is twin-siamese type meeting R.M.A. and C.G.A. type V.D. grade R specifications. Use of other types of hose is not recommended.							
SR17W-150	1/4"	50	200	38	SR17WL-150	26	1
SR19W-175	1/4"	75	200	53	SR19WL-175	36	2
OTHER FUELS Reels with "T Grade" hoses are used for a wide variety of gases, such as MAPP, propane, natural and fuel.							
SR17WT-150	1/4"	50	200	38	SR17WTL-150	26	1
SR19WT-175	1/4"	75	200	53	SR19WTL-175	36	2

Less hose SW Series models comes with inlet hose

SGW SERIES

Do not exceed listed hose O.D. to obtain maximum length.

HOSE						LESS HOSE		SIZE INDEX
MODEL	I.D.	FT.	PSI	APRX. LBS.	EZ-COIL MODELS	MODEL	APRX. LBS.	
OXYGEN-ACETYLENE Oxy-Acetylene is twin-siamese type meeting R.M.A. and C.G.A. type V.D. grade R specifications. Use of other types of hose is not recommended.								
SG17W-150	1/4"	50	200	59	EZ-SG17W-150	SG17WL-150	47	3
SG19W-175	1/4"	75	200	77	EZ-SG19W-175	SG19WL-175	60	4
OTHER FUELS Reels with "T Grade" hoses are used for a wide variety of gases, such as MAPP, propane, natural and fuel.								
SG17WT-150	1/4"	50	200	59	EZ-SG17WT-150	SG17WTL-150	47	3
SG19WT-175	1/4"	75	200	77	EZ-SG19WT-175	SG19WTL-175	60	4

To order EZ-Coil® equipped models less hose, please add prefix "EZ-". Less hose SGW Series models comes with inlet hose

REEL DIMENSIONS

Technical Data Sheets Available On Website

SIZE INDEX	W	H	L	Y	M
1	7 7/8"	18 1/4"	17"	2 1/2"	13"
2	9 1/2"	20 7/8"	19 1/2"	2 1/2"	14 1/4"
3	8 7/8"	19 1/2"	17"	2 1/2"	18"
4	10 1/2"	22"	19 1/2"	2 1/2"	20 1/2"

Overall Dimensions Base Mounting Pattern

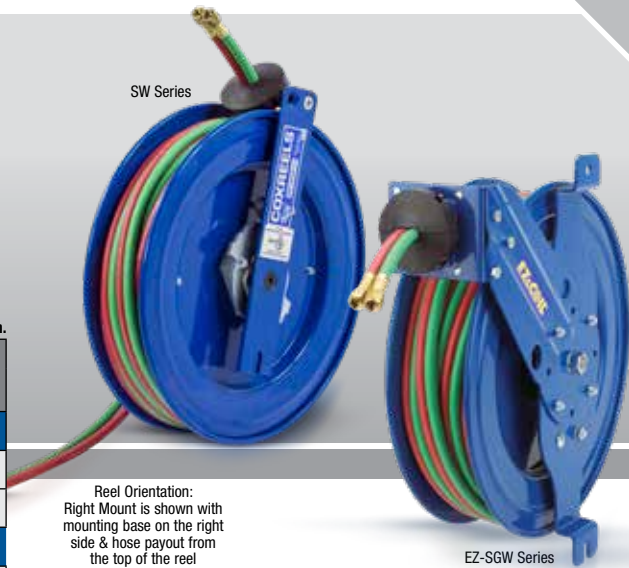
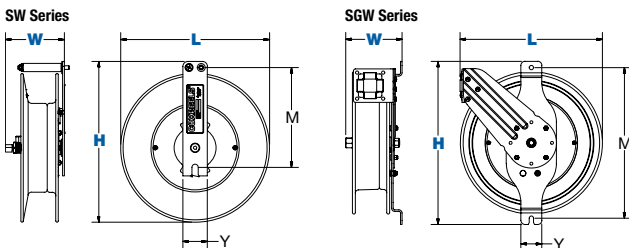

Reel Orientation:
Right Mount is shown with mounting base on the right side & hose payout from the top of the reel

EZ-SGW Series

SW & SGW SERIES :: REEL SPECIFICATIONS

SWIVEL

- External fluid path with 90° full-flow dual ported brass swivel offering both connections from the same side of the reel
- Swivel Seals: VITON®

DESIGN & STRUCTURE

- Side mount design for vertical flat surface, cabinet or enclosed space mounts
- 2-bolt mounting pattern easily mounts & detaches for temporary or permanent installation
- Solid one piece, heavy gauge steel arm base for maximum stability
- 1" solid steel axle & lubricated precision bearings for smooth rotation
- (On SW Models only) Hose control bar prevents hose from slipping off the discs
- (On SGW Models only) Adjustable 6 position guide arm & roller assembly provide maximum hose control

RETRACTION

- Controlled retraction speed up to 80% slower on EZ-COIL models :: See page 7 for details
- Enclosed factory tuned & matched cartridge-style spring motor
- Non corrosive stainless steel spring, pawl & zinc plated ratchet
- Multi-position lock ratchet mechanism secures hose at desired length.
- Non-locking, less ratchet option available (add suffix -BXC)

SIGNATURE FEATURES

- Professional grade heavy duty steel construction
- Durable proprietary CPC™ powder coat process
- Rolled edges & ribbed discs provide strength & safety
- Leading 2-year manufacturer's limited warranty
- Made in the U.S.A. - Sold & Supported Worldwide

POSSIBLE FIELDS OF APPLICATION

- Manufacturing Plants
- Maintenance, Repair & Operations
- Welding / Service Trucks
- Welding Shops
- Garage Settings
- Automotive & Fleet Maintenance
- Pipelines
- Mining, Construction & Railroad Operations

ACCESSORIZE YOUR REEL :: pg 56

- O-Rings & Swivels
- Hoses
- Assorted Reel Accessories



WARNING: Cancer and reproductive Harm – See page 56

COXREELS® MPD, TDMP and 1275HP Series "Dual Hydraulic" hose reels have similar features to their related series, but have been redesigned to handle dual hydraulic applications. Choose between spring driven retraction at 3,000 PSI to 50 feet and hand crank or motorized models at 10,000 PSI to 200 feet.

SPRING DRIVEN DUAL HYDRAULIC SERIES

HOSE						LESS HOSE		SIZE INDEX
MODEL	I.D.	O.D.	FT.	PSI	APRX. LBS.	MODEL	APRX. LBS.	
MPD SERIES Medium pressure reels are furnished standard with dual-hydraulic hose banded together every 2-3 feet with power strip-type clamps. Maximum temperature 212° F.								
-	-	-	-	-	-	MPDL-N-150	62	1
MPD-N-330	3/8"	1 1/16"	30	3,000	78	MPDL-N-330	62	1
MPD-N-430	1/2"	1 3/16"	30	2,500	79	MPDL-N-430	62	1
TDMP SERIES Medium pressure reels are furnished standard with dual-hydraulic hose banded together every 2-3 feet with power strip-type clamps. Maximum temperature 212° F.								
TDMP-N-350	3/8"	1 1/16"	50	3,000	104	TDMP-L-N-350	79	2
TDMP-N-450	1/2"	1 3/16"	50	2,500	106	TDMP-L-N-450	79	2



HAND CRANK DUAL HYDRAULIC SERIES

LESS HOSE							SIZE INDEX	
MODEL	DESCRIPTION	INLET	OUTLET	CAPACITY 1/4" I.D.	CAPACITY 3/8" I.D.	PSI		APRX. LBS.
1125HP SERIES 10,000 psi - two 1/4" 90° inlets. These reels are an essential component to operate hydraulic tools requiring 10,000 psi can be easily managed safely for efficient use in emergency situations.								
1275HPL-4-8	Rim Rewind	1/4"	1/2"	135'	85'	10,000*	37	3
1275HPL-4-8-C	Geared Crank	1/4"	1/2"	135'	85'	10,000*	43	3
1275HPL-4-8-A	Air Motor	1/4"	1/2"	135'	85'	10,000*	50	3
1275HPL-4-8-E	Electric Motor	1/4"	1/2"	135'	85'	10,000*	68	3
1275HPL-4-12	Rim Rewind	1/4"	1/2"	200'	125'	10,000*	39	4
1275HPL-4-12-C	Geared Crank	1/4"	1/2"	200'	125'	10,000*	45	4
1275HPL-4-12-A	Air Motor	1/4"	1/2"	200'	125'	10,000*	52	4
1275HPL-4-12-E	Electric Motor	1/4"	1/2"	200'	125'	10,000*	70	4

SUFFIX "4" OUTLET/ADAPTER OPTIONS

The option "4" is standard but can be adapted for your specific need. Simply replace "4" with an "A, B, C or D" option:

- A** = -4 JIC Male - # **7818**
- B** = -5 JIC Male # **7817** & 1/2" x 3/8" Reducer - # **7540**
- C** = 1/4" BSP Female - # **7821**
- D** = M14 X 1.5 Female - # **7848**

*Use of non-standard outlet/adapter options may reduce typical working pressure safety. Refer to page 52 for specific pressure ratings



DP SERIES

See page 17 for high capacity spring driven dual hydraulic reels



1275 SERIES

See page 46 for medium pressure dual hydraulic hose hand crank & motorized reel

MPD, TDMP & 1275HP SERIES :: REEL SPECIFICATIONS

MPD SERIES

- External fluid path with dual port 90° full-flow 1/2" ORB port swivel inlet
- Swivel Seals: TEFLON
- Sturdy single pedestal design with Coxreels' exclusive Super Hub™ dual axle support system
- One-sided supply/return hookup

TDMP SERIES

- External fluid path with dual port 90° full-flow 1/2" ORB port swivel inlet
- Swivel Seals: TEFLON
- Sturdy triple pedestal design with Coxreels' exclusive Super Hub™ dual axle support system
- One-sided supply/return hookup

1275HP SERIES

- Two high pressure 90° full-flow melanzed steel 1/4" swivel inlets
- Swivel Seals: VITON®
- Designed for dual hydraulic emergency rescue systems & other high pressure hydraulic tools
- Sturdy all welded steel "A" frame, not bolted to strengthen the reel structure
- Two low profile outlet risers & open drum slot design for flat smooth hose wrap (must specify the type of outlets, see outlet options)

SIGNATURE FEATURES

- Professional grade heavy duty steel construction
- Durable proprietary CPC™ powder coat process
- Rolled edges & ribbed discs provide strength & safety
- Leading 2-year manufacturer's limited warranty
- Made in the U.S.A. - Sold & Supported Worldwide

POSSIBLE FIELDS OF APPLICATION

- Service / Mechanic Trucks
- Garage Settings
- Hydraulic Rescue Tools
- Fire Rescue
- Emergency Situations
- Mining, Construction & Railroad Operations
- Cranes

ACCESSORIZE YOUR REEL :: PG 56

- O-Rings & Swivels
- Mounting Brackets
- Hoses
- Assorted Reel Accessories

REEL DIMENSIONS

Technical Data Sheets Available On Website

SIZE INDEX	W			H		L	X	Y		M	N	Ø	Dw
	CRANK / SPRING	ELEC.	AIR	CRANK / SPRING	ELEC.			CRANK / SPRING	ELEC.				
1	11 1/2"	-	-	21 1/8"	-	19 1/2"	6"	6"	-	4"	5"	-	-
2	11 5/8"	-	-	25 1/2"	-	24"	8"	9"	-	7"	8"	-	-
3	17 1/2"	20 1/4"	19 1/4"	18 5/8"	19 1/8"	17 5/8"	13 3/8"	15 3/8"	16"	11 7/16"	10"	6 1/4"	8"
4	21 1/2"	24 1/4"	23 1/4"	18 5/8"	19 1/8"	17 5/8"	17 3/8"	15 3/8"	16"	15 7/16"	10"	6 1/4"	12"

Overall Dimensions Base Mounting Pattern Drum

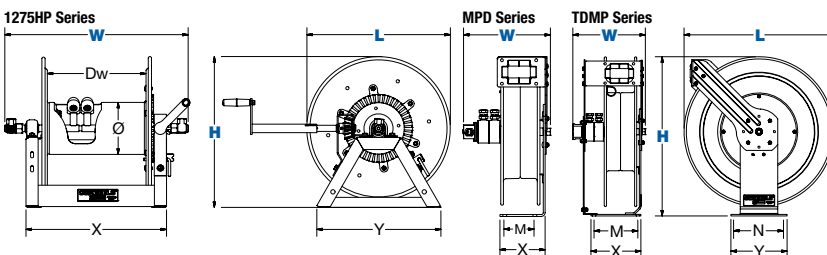

WARNING: Cancer and reproductive Harm – See page 56

3/32" Ø

SD & SDH SERIES STATIC DISCHARGE CABLE REELS



COXREELS® SD and SDH Series "Static Discharge" cable reels are built heavy duty and designed for long lasting performance. They are specifically designed to be used in combustible environments where the static buildup could ignite a spark and subsequent explosion. Static discharge or grounding reels are commonly paired with fuel hose reels.

SD SERIES

CABLE					LESS CABLE		SIZE INDEX
MODEL	FT.	O.D. W/JACKET	APRX. LBS.	EZ-COIL MODELS	MODEL	APRX. LBS.	
GALVANIZED CABLE							
SD-35	35	5/32"	18	EZ-SD-35	-	-	1
SD-50	50	5/32"	20	EZ-SD-50	SDL-50	18	1
SD-75	75	5/32"	31	EZ-SD-75	-	-	2
SD-100	100	5/32"	32	EZ-SD-100	SDL-100	28	2
STAINLESS STEEL CABLE							
SD-35-1	35	5/32"	18	EZ-SD-35-1	-	-	1
SD-50-1	50	5/32"	20	EZ-SD-50-1	SDL-50	18	1
SD-75-1	75	5/32"	31	EZ-SD-75-1	-	-	2
SD-100-1	100	5/32"	32	EZ-SD-100-1	SDL-100	28	2

To order EZ-Coil® equipped models less hose, please add prefix "EZ-"

SDH SERIES

CABLE				LESS CABLE		SIZE INDEX
MODEL	FT.	O.D. W/JACKET	APRX. LBS.	MODEL	APRX. LBS.	
GALVANIZED CABLE						
SDH-100	100	5/32"	24	-	-	3
SDH-200	200	5/32"	28	SDHL-200	20	3
STAINLESS STEEL CABLE						
SDH-100-1	100	5/32"	24	-	-	3
SDH-200-1	200	5/32"	28	SDHL-200	20	3

REEL DIMENSIONS

Technical Data Sheets Available On Website

SIZE INDEX	W	H	L	X	Y	N
1	3 7/8"	11 1/2"	11"	2 1/2"	6"	4"
2	4"	15"	14 1/2"	2 1/2"	6"	4"
3	5 3/4"	11 1/2"	11"	2 1/2"	6"	4"

Overall Dimensions Base Mounting Pattern

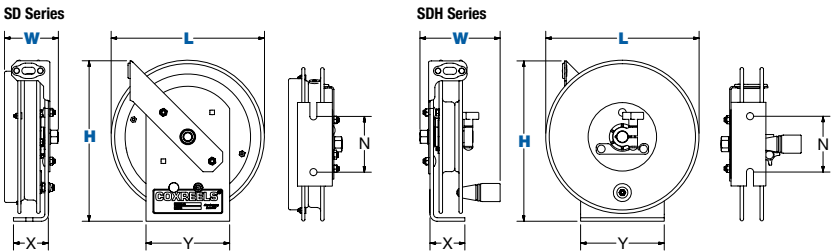

SD & SDH SERIES :: REEL SPECIFICATIONS

STATIC DISCHARGE

- Available with 7 strand x 7 wire galvanized steel or stainless steel 5/32" cable
- High visibility orange vinyl cable cover (O.D.= 5/32" with cable cover)
- Includes cable, ball stop & 50 Amp grounding clamp (100 Amp copper grounding clamp available, consult factory)

DESIGN & STRUCTURE

- Compact static discharge cable reel available in spring rewind or direct hand crank retraction
- Commonly paired with fuel reels & used in combustible environment for grounding purposes
- Guide arm adjusts to wall, floor, vehicle & overhead positions
- Solid one piece, heavy gauge 1/4" steel base for maximum stability
- 1" solid steel axle & lubricated precision bearings for smooth rotation
- Bottom of base is not powder coated to ground reel

RETRACTION

- Controlled retraction speed up to 80% slower on EZ-COIL models :: See page 7 for details
- (On SD Series only) Enclosed factory tuned & matched cartridge-style spring motor
- (On SD Series only) Non corrosive stainless steel spring, pawl & zinc plated ratchet
- (On SD Series only) Multi-position non-sparking lock ratchet mechanism secures cable at desired length
- (On SDH Series only) Simple design with direct hand crank action

SIGNATURE FEATURES

- Professional grade heavy duty steel construction
- Durable proprietary CPC™ powder coat process
- Rolled edges & ribbed discs provide strength & safety
- Leading 2-year manufacturer's limited warranty
- Made in the U.S.A. - Sold & Supported Worldwide

POSSIBLE FIELDS OF APPLICATION

- Fuel / Service Trucks
- Fuel Storage & Dispensing Systems
- Ground Support
- Aviation Static Grounding
- Aviation Refueling
- Vehicle Refueling
- Marine / Ship Refueling / Offshore
- Oil Refinery

ACCESSORIZE YOUR REEL :: PG 56

- Mounting Brackets
- Assorted Reel Accessories

WARNING: Cancer and reproductive Harm – See page 22 of MSDS

SPRING DRIVEN

EZ-COIL®

HAND CRANK

3/4" - 1" I.D.

FUEL SERIES

SPRING DRIVEN FUEL HOSE REELS



COXREELS® Fuel Dispensing Reels are designed to handle various non-aromatic fuel applications including diesel, kerosene, fuel oil and heating oil. Coxreels® professional fuel dispensing reels are available in heavy-duty single pedestal (SH Series), supreme-duty dual pedestal (T Series) or box-style frame (SP Series) configurations. These fuel reels are an essential component found in utility, ground support, and bulk liquid handling transport services mounted on fuel storage & dispensing systems, fuel/lube trucks, aircraft refuelers, and tank trucks. The convenient uncoiling systems with the added hose control allow the operator to efficiently handle fuel transfers.

FUEL HOSE SERIES

Models are equipped with fuel hose. **Note:** Do not exceed listed hose O.D. to obtain maximum length.

HOSE							LESS HOSE		SIZE INDEX
MODEL	I.D.	O.D.	FT.	PSI	APRX. LBS.	EZ-COIL MODELS	MODEL	APRX. LBS.	
FUEL HOSE SH SERIES									
SHF-N-525	3/4"	1 3/16"	25	300	52	EZ-SHF-525	*SHFL-N-525	45	1
FUEL HOSE T SERIES									
TSHF-N-535	3/4"	1 3/16"	35	300	77	EZ-TSHF-535	TSHFL-N-535	67	2
TSHF-N-550	3/4"	1 3/16"	50	300	83	EZ-TSHF-550	*TSHFL-N-550	70	2
TSHF-N-575	3/4"	1 3/16"	75	300	93	-	TSHL-N-575-BXN	73	3
TSHF-N-635	1"	1 1/2"	35	300	92	-	TSHL-N-635-BXN	71	4
TSHF-N-650	1"	1 1/2"	50	300	98	-	TSHL-N-650-BXN	77	3
FUEL HOSE XTM SERIES									
XTMF-LP-550	3/4"	1 1/16"	50	300	94	-	-	-	5
XTMF-LP-550-GS	3/4"	1 1/16"	50	300	94	-	-	-	5
XTMF-LP-575	3/4"	1 1/16"	75	300	101	-	-	-	5
XTMF-LP-650	1"	1 1/2"	50	300	114	-	-	-	6
XTMF-LP-650-GS	1"	1 1/2"	50	300	114	-	-	-	6
FUEL HOSE SP SERIES									
SLPF-550	3/4"	1 1/16"	50	300	99	-	SLPL-550	86	7
SLPF-575	3/4"	1 1/16"	75	300	136	-	SLPL-575	117	8
SLPF-5100	3/4"	1 1/16"	100	300	151	-	SLPL-5100	126	8
SLPF-625	1"	1 1/2"	25	300	106	-	SLPL-625	90	9
SLPF-650	1"	1 1/2"	50	300	139	-	SLPL-650	109	10
SLPF-675	1"	1 1/2"	75	300	193	-	SLPL-675	148	11

* EZ-Coil® option only available on these less hose models. Please add prefix "EZ-"

REEL DIMENSIONS

Technical Data Sheets Available On Website

SIZE INDEX	W	H	L	X	Y	M	N
1	9 3/8"	21 1/4"	19 1/2"	6"	6"	4"	5"
2	9 7/8"	25 1/2"	24"	8"	9"	7"	8"
3	12"	25 1/2"	24"	8"	9"	7"	8"
4	10"	25 1/2"	24"	8"	9"	7"	8"
5	10 1/8"	26 1/8"	24 1/16"	10"	15"	8 29/32"	10"
6	12 3/4"	26 1/8"	24 1/16"	12 3/4"	15"	11 1 1/16"	10"
SIZE INDEX	W	H	L	X	Y	Ø	Dw
7	19 5/8"	20 1/2"	22 7/8"	15 3/8"	21 1/2"	10 1/2"	7 1/2"
8	19 5/8"	24 1/2"	26 3/8"	15 3/8"	25"	10 1/2"	7 1/2"
9	21"	20 1/2"	22 7/8"	15 3/8"	21 1/2"	10 1/2"	7 1/2"
10	21"	24 1/2"	26 3/8"	15 3/8"	25"	10 1/2"	7 1/2"
11	21"	28 1/2"	30 3/8"	15 3/8"	29"	10 1/2"	7 1/2"

Overall Dimensions

Base

Mounting Pattern

DIMENSIONAL DRAWING

- See page 12 for SH Series dim drawings
- See page 13 for T Series dim drawings

- See page 14 for XTM Series dim drawings
- See page 17 for SP Series dim drawings

FUEL SERIES :: REEL SPECIFICATIONS

SWIVEL

- Machined from solid brass 90° full-flow NPT swivel inlet for fuel dispensing applications. Electroless nickel plated steel swivel on 1" models
- Swivel seals: Nitrile

HOSE

- Fuel dispensing hose designed to convey non-aromatic fuels including diesel, kerosene, fuel oil & heating oil. Temperature Range: -20°F to +190°F
- (On -GS Models only) Fuel dispensing hose designed to convey aromatic fuels.

DESIGN & STRUCTURE

- Each of these reels is built of their standard series with their own unique features & benefits
- Non-sparking mechanism

RETRACTION

- See page 12 for SH Series spring driven features
- See page 13 for T Series spring driven features
- See page 14 for XTM Series spring driven features
- See page 17 for SP Series spring driven features

SIGNATURE FEATURES

- Professional grade heavy duty steel construction
- Durable proprietary CPC™ powder coat process
- Rolled edges & ribbed discs provide strength & safety
- Leading 2-year manufacturer's limited warranty
- Made in the U.S.A. - Sold & Supported Worldwide

POSSIBLE FIELDS OF APPLICATION

- Vehicle Refueling
- Tank Trucks
- Fuel/Lube Trucks
- Fuel Storage & Dispensing Systems
- DEF Storage & Dispensing Systems
- Aircraft Refueling
- Marine/Ship Refueling/Offshore

ACCESSORIZE YOUR REEL :: pg 56

- O-Rings & Swivels
- Mounting Brackets
- Hoses
- Assorted Reel Accessories

WARNING: Cancer and reproductive Harm – See page 22

SPRING DRIVEN

EZ-COIL®

COXREELS® E Series "Expandable" multiple bank system is the pinnacle in professional appearance and organization. The cabinets are interlocking and expandable to any number of spring driven reel assemblies required. Designed for easy installation, maintenance and servicing the E Series system is truly the professional's choice for multimedia delivery in one custom package.

E SERIES

Do not exceed listed hose O.D. to obtain maximum length.

HOSE						LESS HOSE			SIZE INDEX
MODEL	I.D.	O.D.	FT.	PSI	APRX. LBS.	MODEL	APRX. LBS.		
LOW PRESSURE						Models with hose are for air water service with a maximum temperature 150°F. Models less hose can be used for air, water or oil.			
E-LP-330	3/8"	5/8"	30	300	33	EZ-E-LP-330	E-LPL-330	29	1
E-LP-350	3/8"	5/8"	50	300	46	EZ-E-LP-350	E-LPL-350	40	2
E-LP-430	1/2"	3/4"	30	300	41	EZ-E-LP-430	E-LPL-430	36	1
E-LP-450	1/2"	3/4"	50	300	50	EZ-E-LP-450	E-LPL-450	42	2
MEDIUM PRESSURE						Reels are furnished with standard one wire braid hose suitable for air, water or oil applications. Hose exceeds SAE R1 specifications. Maximum Temperature 250°F.			
E-MP-330	3/8"	5/8"	30	3,000	47	EZ-E-MP-330	E-MPL-330	39	1
E-MP-350	3/8"	5/8"	50	3,000	61	EZ-E-MP-350	E-MPL-350	49	2
E-MP-430	1/2"	3/4"	30	2,500	47	EZ-E-MP-430	E-MPL-430	39	1
E-MP-450	1/2"	3/4"	50	2,500	63	EZ-E-MP-450	E-MPL-450	49	2
HIGH PRESSURE						Reels are furnished standard with S.A.E. 100R16 #1 or #2 wire braid hose suitable for grease and hydraulic oil applications. Maximum Temperature 250°F.			
E-HP-130	1/4"	9/16"	30	5,000	46	EZ-E-HP-130	E-HPL-130	39	3
E-HP-150	1/4"	9/16"	50	5,000	60	EZ-E-HP-150	E-HPL-150	49	4
E-HP-330	3/8"	11/16"	30	4,000	47	EZ-E-HP-330	E-HPL-330	39	3
E-HP-350	3/8"	11/16"	50	4,000	61	EZ-E-HP-350	E-HPL-350	49	4

To order EZ-Coil® equipped models less hose, please add prefix "EZ-"

REEL DIMENSIONS

Technical Data Sheets Available On Website

SIZE INDEX	W	H	L	X	Y	M	N
1	6 1/8"	18 1/4"	17 1/4"	6"	6"	4"	5"
2	8 3/4"	21"	19 5/8"	6"	6"	4"	5"
3	7"	18 1/4"	17 1/4"	6"	6"	4"	5"
4	9 1/4"	21"	19 5/8"	6"	6"	4"	5"

Overall Dimensions Base Mounting Pattern

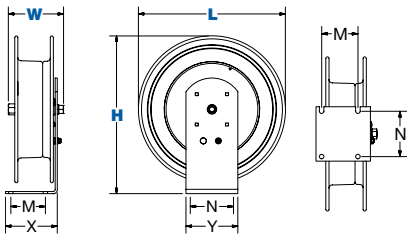

Cabinet illustration (above) shows three reels, three metal cabinets, & one set of end panels

E SERIES :: REEL SPECIFICATIONS

SWIVEL

- External fluid path with machined from solid brass 90° full-flow NPT swivel inlet (Zinc plated steel swivel on HP models)
- Swivel Seals: NITRILE

DESIGN & STRUCTURE

- Designed for expandable metal cabinets & multiple reel bank systems
- Solid one piece, heavy gauge 1/4" steel base & support post for maximum stability
- 1" solid steel axle & lubricated precision bearings for smooth rotation

RETRACTION

- Controlled retraction speed up to 80% slower on EZ-COIL models :: See page 7 for details
- Enclosed factory tuned & matched cartridge-style spring motor
- Non corrosive stainless steel spring, pawl & zinc plated ratchet
- Multi-position lock ratchet mechanism secures hose at desired length

SIGNATURE FEATURES

- Professional grade heavy duty steel construction
- Durable proprietary CPC™ powder coat process
- Rolled edges & ribbed discs provide strength & safety
- Leading 2-year manufacturer's limited warranty
- Made in the U.S.A. - Sold & Supported Worldwide

POSSIBLE FIELDS OF APPLICATION

- Air/Water Services
- Pneumatic Tools
- Washdown
- Lubrication
- Chemical Fluid Transfer
- Cabinet Mount
- Manufacturing Plants & Facilities
- Maintenance, Repair & Operations
- Automotive Dealerships
- Quick Lube Service Centers

ACCESSORIZE YOUR REEL :: PG 56

- O-Rings & Swivels
- Mounting Cabinet
- Hoses
- Assorted Reel Accessories

COXREELS® ACCESSORY

Cabinet
Length: 24 1/2" Width: 11 1/8" Height: 22 1/4"

- Unlimited expandability
- Easy to install
- Cabinet constructed of 14 gauge steel with 4-roller non-sag hose guide system for reduced hose wear
- All steel access panel
- Mounting bracket is 3/16" bent steel, fits 3" to 8 1/2" flange on "I" or "H" beam
- Easy access for connection of air, water, oil & grease

METAL CABINET: #1796-2
Includes cabinet, access panel & mounting bracket. Weight: 45 lbs.

END PANELS: #1798-1
Includes a set of two, all steel construction. Finished & caps the ends of each bank. Weight: 8 lbs.



WARNING: Cancer and reproductive Harm – See page 66

3/8" - 1/2" I.D.

HV SAFETY HOSE SERIES



EZ-P-HV Series

LG-HV Series

T-HV Series

COXREELS® HV "High Visibility" Safety Hose Series powers up the safety of your reel. The HV Hose will add awareness and visibility to your hose creating the safest environment possible. To maximize your safety to the highest level, add EZ-Coil controlled retraction to your Coxreels. Featured on LG, P, SH, and T Series on 3/8" or 1/2" hose.

HIGH VISIBILITY SAFETY HOSE SERIES

HOSE										DIMENSIONS							
MODEL	I.D.	O.D.	FT.	PSI	APRX. LBS.	EZ-COIL MODELS	W	H	L	X	Y	M	N				
LG SERIES										Models with hose are for air water service with a maximum temperature 150°F. Models less hose can be used for air, water or oil.							
LG-LP-320-HV	3/8"	5/8"	20	300	11	-	5 1/4"	10 5/8"	10 1/2"	4 1 1/16"	8 3/8"	2 1/2"	6"				
P SERIES										Models with hose are for air water service with a maximum temperature 150°F. Models less hose can be used for air, water or oil.							
P-LP-325-HV	3/8"	5/8"	25	300	28	EZ-P-LP-325-HV	6 1/2"	14 7/8"	13 1/2"	5"	6"	3"	5"				
P-LP-350-HV	3/8"	5/8"	50	300	43	EZ-P-LP-350-HV	6 3/4"	18 5/8"	17 1/8"	6"	6"	4"	5"				
P-LP-425-HV	1/2"	3/4"	25	300	44	-	7"	18 5/8"	17 1/8"	6"	6"	4"	5"				
P-LP-450-HV	1/2"	3/4"	50	300	48	EZ-P-LP-450-HV	7"	18 5/8"	17 1/8"	6"	6"	4"	5"				
SH SERIES										Models with hose are for air water service with a maximum temperature 150°F. Models less hose can be used for air, water or oil.							
SH-N-350-HV	3/8"	5/8"	50	300	50	EZ-SH-350-HV	8 1/4"	21 1/4"	19 1/2"	6"	6"	4"	5"				
SH-N-375-HV	3/8"	5/8"	75	300	68	EZ-SH-375-HV	8 1/4"	25 1/2"	24"	6"	6"	4"	5"				
SH-N-3100-HV	3/8"	5/8"	100	300	71	EZ-SH-3100-HV	8 1/4"	25 1/2"	24"	6"	6"	4"	5"				
SH-N-450-HV	1/2"	3/4"	50	300	54	EZ-SH-450-HV	8 1/4"	21 1/4"	19 1/2"	6"	6"	4"	5"				
SH-N-475-HV	1/2"	3/4"	75	300	68	EZ-SH-475-HV	8 3/4"	25 1/2"	24"	6"	6"	4"	5"				
SH-N-4100-HV	1/2"	3/4"	100	300	81	EZ-SH-4100-HV	8 3/4"	25 1/2"	24"	6"	6"	4"	5"				
T SERIES										Models with hose are for air water service with a maximum temperature 150°F. Models less hose can be used for air, water or oil.							
TSH-N-350-HV	3/8"	5/8"	50	300	61	EZ-TSH-350-HV	9 3/8"	21 1/4"	19 1/2"	8"	9"	7"	8"				
TSH-N-375-HV	3/8"	5/8"	75	300	82	EZ-TSH-375-HV	9 3/8"	25 1/2"	24"	8"	9"	7"	8"				
TSH-N-3100-HV	3/8"	5/8"	100	300	85	EZ-TSH-3100-HV	9 3/8"	25 1/2"	24"	8"	9"	7"	8"				
TSH-N-450-HV	1/2"	3/4"	50	300	63	EZ-TSH-450-HV	9 3/8"	21 1/4"	19 1/2"	8"	9"	7"	8"				
TSH-N-475-HV	1/2"	3/4"	75	300	82	EZ-TSH-475-HV	9 3/8"	25 1/2"	24"	8"	9"	7"	8"				
TSH-N-4100-HV	1/2"	3/4"	100	300	95	EZ-TSH-4100-HV	9 3/8"	25 1/2"	24"	8"	9"	7"	8"				

HV SAFETY HOSE SERIES :: REEL SPECIFICATIONS

- SWIVEL**
- External fluid path with machined from solid brass 90° full-flow NPT swivel
 - Swivel Seals: NITRILE
- HOSE**
- Hybrid (PVC + Rubber) bright yellow hose with a white glossy stripe.
 - Superior visibility, increased hose flexibility, enhanced kink resistance and reduced coil memory.
 - Temperature range: -40°F to 158°F (-40°C to 70°C)
 - 300 PSI at 70°F

- DESIGN & STRUCTURE**
- Each of these reels is built of their standard series with their own unique features & benefits

- RETRACTION**
- Enclosed factory tuned & matched cartridge-style spring motor
 - On P, SH, & T Series - Controlled retraction speed up to 80% slower on EZ-COIL models. Non-corrosive stainless steel spring, pawl & zinc plated ratchet. Multi-position lock ratchet mechanism secures hose at desired length.

- SIGNATURE FEATURES**
- Professional grade heavy duty steel construction
 - Durable proprietary CPC™ powder coat process
 - Rolled edges & ribbed discs provide strength & safety
 - Leading 2-year manufacturer's limited warranty
 - Made in the U.S.A. - Sold & Supported Worldwide

- POSSIBLE FIELDS OF APPLICATION**
- Air/Water Services
 - Pneumatic Tools
 - Washdown
 - Lubrication
 - Service / Mechanic / Utility Vehicles
 - Chemical Fluid Transfer
 - General Industrial
 - Manufacturing Plants & Facilities
 - Maintenance, Repair & Operations
 - Automotive & Fleet Service Centers

- ACCESSORIZE YOUR REEL :: Pg 56**
- O-Rings & Swivels
 - Mounting Brackets
 - Hoses
 - Assorted Reel Accessories

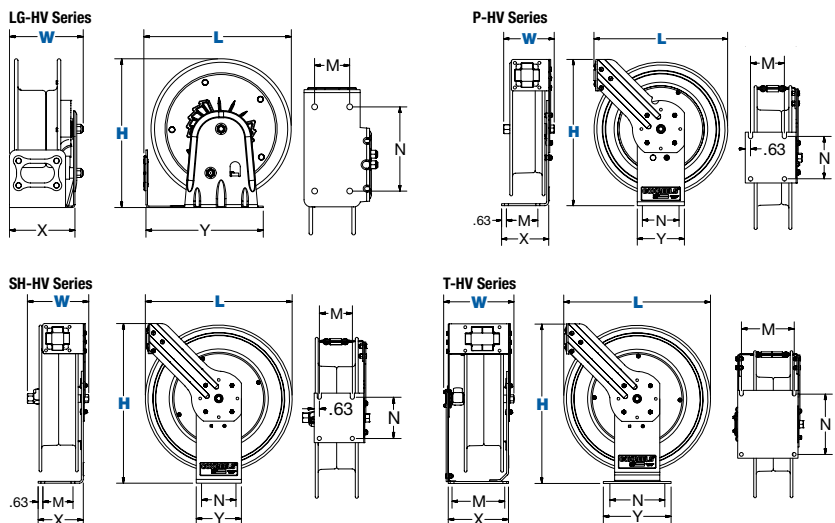

WARNING: Cancer and reproductive Harm – See page 22 of the Safety Data Sheet (SDS)

SPRING DRIVEN
EZ-COIL®

PURE FLOW SERIES

BREATHING AIR & CLEAN FLUID HOSE REELS

3/8" - 1/2" I.D.



Pure Flow 1125-E Series

Pure Flow EZ-P Series

Pure Flow 100 Series

Pure Flow CM Series

COXREELS® Pure Flow Series is offered in spring rewind, hand crank and motorized retractions. All Pure Flow hose reels come standard equipped with stainless steel air/fluid paths and stainless steel swivels with non-toxic, food quality grease, ensuring clean, non-contaminated, safe and reliable transfer of breathing air, potable water or other clean fluids.

PURE FLOW SPRING DRIVEN SERIES

Do not exceed listed hose O.D. to obtain maximum length.

LESS HOSE						SIZE INDEX
MODEL	I.D.	O.D.	FT.	PSI	APRX. LBS.	
EZ-P SERIES Models with hose are for air or water service with a maximum temperature 150°F. Models less hose can be used for air, water or oil.						
EZ-P-BLL-350	3/8"	5/8"	50	300	43	1
EZ-P-BHL-350	3/8"	5/8"	50	6,000	43	1
EZ-T SERIES Models with hose are for air or water service with a maximum temperature 150°F. Models less hose can be used for air, water or oil.						
EZ-TBLL-3100	3/8"	5/8"	100	300	85	2
EZ-TBHL-3100	3/8"	5/8"	100	6,000	85	2

PURE FLOW COMPACT HAND CRANK SERIES

LESS HOSE						SIZE INDEX
MODEL	I.D.	O.D.	FT.	PSI	APRX. LBS.	
100 SERIES						
112P-3-8	3/8"	5/8"	100	4,000	19	3
CM SERIES						
112P-3-8-CM	3/8"	5/8"	100	4,000	18	3

PURE FLOW HAND CRANK & MOTORIZED SERIES

LESS HOSE										SIZE INDEX
MODEL	STANDARD CAP			OPTIONAL CAP. Reducer required			INLET SWIVEL & OUTLET RISER	PSI	APRX. LBS.	
	I.D.	O.D.	FT.	I.D.	O.D.	FT.				
1125 SERIES										
1125P-4-6	1/2"	7/8"	100	3/8"	3/4"	140	1/2" F NPT	6,000	36	4
1125P-4-8	1/2"	7/8"	150	3/8"	3/4"	200	1/2" F NPT	6,000	37	5
1125P-4-12	1/2"	7/8"	200	3/8"	3/4"	300	1/2" F NPT	6,000	39	6

MOTOR OPTIONS

When ordering, suffix the model number with selection below. NOTE: Add 5 lbs to ship weight if reel is crated

SUFFIX	TYPE	DESCRIPTION	ADD ON APRX. LBS
A	AIR - 4 VANE	ALUMINIUM BODY AIR MOTOR	8
C	FRONT HAND CRANK	BEVEL GEARED CRANK	3
E	12 V DC, 1/3 HP	REVERSABLE	13
EA	115 V AC, 1/2 HP EXP.	REVERSABLE AC RECTIFIED	26
EB	24 V DC, 1/2 HP EXP.	EXPLOSION PROOF, REVERSABLE	26
ED	12 V DC, 1/2 HP EXP.	EXPLOSION PROOF, REVERSABLE	26
EF	24 V DC, 1/3 HP	REVERSABLE	13
H	HYDRAULIC	END PORTED 9/16-18 UNF	6

REEL DIMENSIONS

Technical Data Sheets Available On Website

SIZE INDEX	W		H		L	X	Y		M	N	Ø	Dw
	CRANK / ELEC / SPRING	AIR / HYD.	CRANK / SPRING	MOTOR			CRANK / SPRING	MOTOR				
1	7 1/8"	-	18 5/8"	-	17 1/8"	6"	6"	-	4"	5"	1 11/8"	3 3/4"
2	9 3/8"	-	25 1/2"	-	24"	8"	9"	-	7"	8"	1 5/4"	4 1/2"
3	18 1/4"	-	13"	-	12"	9 1/2"	6"	-	5 1/2"	3"	5 1/2"	8"
4	19 3/4"	17"	18 5/8"	19 1/4"	17 5/8"	11 3/8"	15 3/8"	16"	9 7/16"	10"	6 1/4"	6"
5	21 3/4"	19"	18 5/8"	19 1/4"	17 5/8"	13 3/8"	15 3/8"	16"	11 7/16"	10"	6 1/4"	8"
6	25 3/4"	23"	18 5/8"	19 1/4"	17 5/8"	17 3/8"	15 3/8"	16"	15 7/16"	10"	6 1/4"	12"

Overall Dimensions

Base

Mounting Pattern

Drum

- See page 11 For P Series dim drawing
- See page 13 For T Series dim drawing
- See page 40 For 100 Series dim drawing

- See page 41 For CM Series dim drawing
- See page 44 For 1125 Series dim drawing

PURE FLOW SERIES :: REEL SPECIFICATIONS

SWIVEL

- Non-corrosive stainless steel air/fluid path with machined from high quality stainless steel 90° full-flow NPT swivel inlet
- Swivel Seals: NITRILE Non-Toxic Food Grade Grease

DESIGN & STRUCTURE

- Safely store respiratory air hose lines for low or high pressure breathing air systems
- Safely store potable water hose lines for drinking water systems
- Safely store any hose requiring sanitized & non-contaminated fluid transfer application
- Each of these reels is built of their standard series with their own unique features & benefits

RETRACTION

- See page 11 for P Series retraction features
- See page 13 for T Series retraction features
- See page 40 for 100 Series retraction features
- See page 41 for CM Series retraction features
- See page 44 for 1125 Series retraction features

SIGNATURE FEATURES

- Professional grade heavy duty steel construction
- Durable proprietary CPC™ powder coat process
- Rolled edges & ribbed discs provide strength & safety
- Leading 2-year manufacturer's limited warranty
- Made in the U.S.A. - Sold & Supported Worldwide

POSSIBLE FIELDS OF APPLICATION

- Low Pressure Breathing Air Systems
- High Pressure Breathing Air Systems
- Fire Rescue
- Medical & Hospital Air Services
- Mining/Tunneling Operations
- Pharmaceutical Manufacturing
- Marine/Docks/Offshore
- High Pressure Cylinder Filling (SCUBA/SCBA)
- Shot Blasting
- Tank Cleaning
- Spray Painting
- Hazardous Site Cleanup
- Commercial Kitchens
- Pre-Rinse
- Potable Water
- Bulk Food
- Food Grade Washdown
- Food & Chemical Processing Plants

ACCESSORIZE YOUR REEL :: PG 56

- O-Rings & Swivels
- Mounting Brackets
- Hoses
- Assorted Reel Accessories

WARNING: Cancer and reproductive Harm – See page 22

SPRING DRIVEN

EZ-COIL®

MOTORIZED

HAND CRANK

STAINLESS STEEL SPRING RETRACTABLE HOSE REELS

SS SERIES

SS-EN Series

COXREELS® SS Series "Stainless Steel" spring driven hose reels have similar features to their related series, but are constructed of high quality electro-polished stainless steel with stainless steel fluid paths. They offer clean, non-corrosive performance in applications that require it, such as food and chemical processing, marinas, and anywhere that rust, corrosion and contamination thrive.

SS SERIES

LESS HOSE						SIZE INDEX
MODEL	I.D.	O.D.	FT.	PSI	APRX. LBS.	
P SERIES						
P-LPL-335-SS	3/8"	1/2"	35	300	34	1
P-LPL-350-SS	3/8"	5/8"	50	300	39	1
P-LPL-425-SS	1/2"	3/4"	25	300	39	2
SH & MP SERIES						
SHL-N-350-SS	3/8"	5/8"	50	300	44	3
SHL-N-450-SS	1/2"	3/4"	50	300	46	3
SHL-N-525-SS	3/4"	1 1/16"	25	300	45	4
MPL-N-350-SS	3/8"	1 1/16"	50	3,000	53	3
MPL-N-450-SS	1/2"	1 3/16"	50	2,500	53	3
T SERIES						
TSHL-N-350-SS	3/8"	5/8"	50	300	55	5
TSHL-N-375-SS	3/8"	5/8"	75	300	73	6
TSHL-N-3100-SS	3/8"	5/8"	100	300	74	6
TSHL-N-450-SS	1/2"	3/4"	50	300	55	5
TSHL-N-475-SS	1/2"	3/4"	75	300	71	6
TSHL-N-4100-SS	1/2"	3/4"	100	300	80	6
TSHL-N-550-SS	3/4"	1 1/16"	50	300	70	7
TMPL-N-3100-SS	3/8"	1 1/16"	100	3,000	82	6
TMPL-N-4100-SS	1/2"	1 3/16"	100	3,000	80	6
EN SERIES						
ENL-N-335-SS	3/8"	5/8"	35	300	46	8
ENL-N-350-SS	3/8"	5/8"	50	300	58	9
ENL-N-425-SS	1/2"	3/4"	25	300	63	8
ENL-N-450-SS	1/2"	3/4"	50	300	61	9
ENML-N-335-SS	3/8"	1 1/16"	35	3,000	64	8
ENML-N-350-SS	3/8"	1 1/16"	50	3,000	80	9
ENML-N-425-SS	1/2"	1 3/16"	25	2,500	61	8
ENML-N-450-SS	1/2"	1 3/16"	50	2,500	82	9



SS SERIES - SPRING - REEL SPECIFICATIONS

SWIVEL

- Non-corrosive external fluid path with machined from high quality stainless steel 90° full-flow NPT swivel inlet
- Swivel Seals: NITRILE Non-Toxic Food Grade Grease

DESIGN & STRUCTURE

- Electro-polished stainless steel finish
- Each of these reels is built of their standard series with their own unique features & benefits

RETRACTION

- Enclosed factory tuned & matched cartridge-style spring motor
- Non corrosive stainless steel spring, pawl & zinc plated ratchet
- Multi-position lock ratchet mechanism secures hose at desired length

SIGNATURE FEATURES

- Professional grade heavy duty steel construction
- Rolled edges & ribbed discs provide strength & safety
- Leading 2-year manufacturer's limited warranty
- Made in the U.S.A. - Sold & Supported Worldwide

POSSIBLE FIELDS OF APPLICATION

- Corrosive Environments
- Hygienic Environments
- Medical Services
- Marine/Docks/Offshore
- Manufacturing Plants & Facilities
- Pulp & Paper Plants
- Food & Chemical Processing Plants
- Bottling Plants
- Dairies
- Meat Packing
- Grocery Stores
- Restaurants & Commercial Kitchens
- Water Treatment & Supply
- Petrochemical
- Food Grade Washdown

ACCESSORIZE YOUR REEL :: PG 56

- O-Rings & Swivels
- Mounting Brackets
- Hoses
- Assorted Reel Accessories

REEL DIMENSIONS

Technical Data Sheets Available On Website

SIZE INDEX	W	H	L	X	Y	M	N
1	6 3/4"	18 5/8"	17 1/8"	6"	6"	4"	5"
2	7"	18 5/8"	17 1/8"	6"	6"	4"	5"
3	8 1/4"	21 1/4"	19 1/2"	6"	6"	4"	5"
4	9 3/8"	21 1/4"	19 1/2"	6"	6"	4"	5"
5	9 3/8"	21 1/4"	19 1/2"	8"	9"	7"	8"
6	9 3/8"	25 1/2"	24"	8"	9"	7"	8"
7	9 7/8"	25 1/2"	24"	8"	9"	7"	8"
8	6 7/8"	18 7/8"	19"	6"	6"	4"	5"
9	8 1/2"	21 3/4"	21 7/8"	6"	6"	4"	5"

Overall Dimensions Base Mounting Pattern

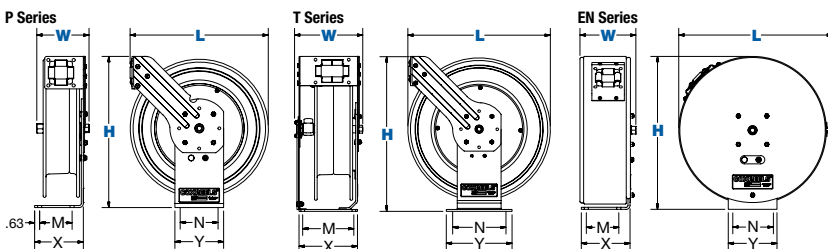

WARNING: Cancer and reproductive Harm – See page 56

SPRING DRIVEN

FOCUS ON THE FEATURES *HAND CRANK & MOTOR DRIVEN REELS*



PROFESSIONAL GRADE FEATURES



Go online to view videos of features & benefits at www.COXREELS.com

HEAVY DUTY SOLID SPUN DISCS WITH ROLLED EDGES - Not stamped, made with first of its kind CNC robotic spinning cell

LOW PROFILE RISER & OPEN DRUM SLOT for smooth, even hose wraps

ZINC PLATED PLUMBING for applications requiring superior oxidation prevention

Only on 1/2" 1125 Series

INDUSTRIAL GRADE BRASS, machined from solid, full flow swivel with external fluid path for ease of seal maintenance

PERMANENTLY LUBRICATED PILLOW BLOCK BEARINGS for easy rotation

HIGH QUALITY STEEL CONSTRUCTION with our durable CPC™ powder coat finish

ONE PIECE ALL CNC ROBOTICALLY WELDED steel "A" frame construction

ALSO AVAILABLE WITH STAINLESS STEEL construction & swivel

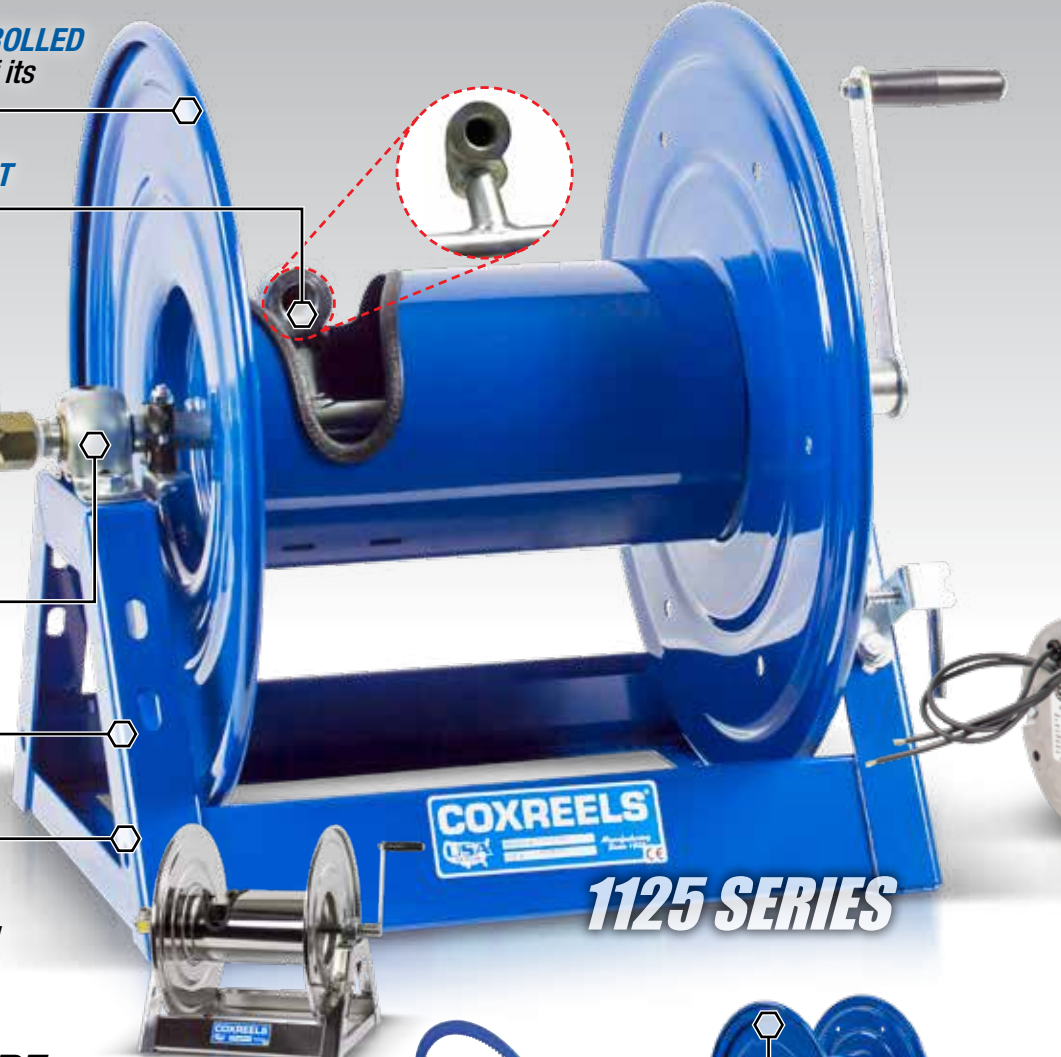

1125 SERIES

ELECTRIC MODELS FEATURE:

1125 SERIES FEATURES A SOLID STEEL RING GEAR welded to the disc for a direct gear driven motor. Chain & sprocket rewind on 1175, 1185 & 1195 Series

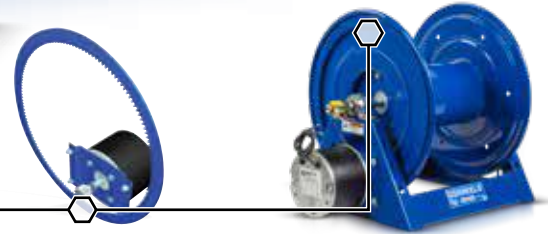

OTHER SERIES BUILT ON THE SAME DESIGN INCLUDE



1175 SERIES

1185 SERIES

1195 SERIES

MOTORIZED
HAND CRANK

GOODYEAR
RUBBER PRODUCTS, INC.

727-342-5088

You can also email us at GRP@goodyearrubberproducts.com

PROFESSIONAL GRADE FEATURES



HEAVY DUTY SOLID SPUN DISCS WITH ROLLED EDGES - Not stamped, made with first of its kind CNC robotic spinning cell

LOW PROFILE RISER & OPEN DRUM SLOT maintains maximum capacity & smooth hose wraps

ZINC PLATED PLUMBING for applications requiring superior oxidation prevention

FULLY SUPPORTED DRUM COMPRESSED ON DISC CENTERS provides maximum rigidity for heavy duty use

PERMANENTLY LUBRICATED SELF-ALIGNING BEARINGS allows trouble free, smooth operation

EXTERNAL FLUID PATH WITH NICKEL PLATED STEEL SWIVEL for simple seal maintenance and fast & easy hose installation

WELDED STEEL "HYBRID" FRAME offers the strength of an "A" frame with the versatility of a box frame for superior reel structure

HIGH QUALITY STEEL CONSTRUCTION with our durable CPC™ powder coat finish

**REEL SHOWN WITH MOTOR REWIND
(Also available in Hand Crank)*

FOR ALL HAND CRANK & MOTORIZED SERIES

CHOICE OF MOTORS
to customize your reel to your specific needs



CHOICE OF UPGRADES
pin lock, brakes, roller brackets, and more...



Go online to download the 1600 Brochure for more info at www.COXREELS.com

3/8" - 3/4" I.D.

100 SERIES

COMPACT HAND CRANK HOSE REELS

COXREELS® 100 Series hand crank hose reels are **lightweight, compact, versatile reels that perform at working pressures up to 4,000 PSI.** Save time and effort while increasing the safety of your work environment. The sturdy "U" shaped frame and all steel construction make this one tough little reel. All listed models are supplied less hose. Stainless steel models are available.

100 SERIES - ALL REELS SUPPLIED LESS HOSE

MODEL	LESS HOSE						PSI	APRX LBS.	SIZE INDEX
	STANDARD CAPACITY			OPTIONAL CAPACITY Reducer Required					
	I.D.	O.D.	FT.	I.D.	O.D.	FT.			
112-3-50	3/8"	5/8"	50	1/4"	1/2"	85	4,000	15	1
112-3-100	3/8"	5/8"	100	1/4"	1/2"	150	4,000	19	2
112-3-150	3/8"	5/8"	150	1/4"	1/2"	225	4,000	21	3
117-3-250	3/8"	5/8"	250	1/4"	1/2"	350	4,000	30	4
117-3-400	3/8"	5/8"	400	1/4"	1/2"	550	4,000	33	5
117-3-550	3/8"	5/8"	550	1/4"	1/2"	800	4,000	35	6
112-4-75	1/2"	7/8"	75	3/8"	3/4"	100	4,000	21	3
117-4-225	1/2"	7/8"	225	3/8"	3/4"	315	4,000	31	5
117-4-350	1/2"	7/8"	350	3/8"	3/4"	450	4,000	37	6
117-5-100	3/4"	1 1/4"	100	1/2"	1"	150	4,000	35	7

100 SERIES :: REEL SPECIFICATIONS

SWIVEL

- Machined from solid 90° full-flow NPT swivel inlet
- Swivel Seals: NITRILE
- Up to 4,000 PSI working pressure

DESIGN & STRUCTURE

- Professional grade, compact & lightweight design
- Open drum design for no hassle hose wrap
- Solid one piece, heavy gauge steel "U" shaped frame
- Adjustable tension brake to prevent "free-wheeling" during operation, transport or storage

RETRACTION

- Direct hand crank rewind

SIGNATURE FEATURES

- Professional grade heavy duty steel construction
- Durable proprietary CPC™ powder coat process
- Rolled edges & ribbed discs provide strength & safety
- Leading 2-year manufacturer's limited warranty
- Made in the U.S.A. - Sold & Supported Worldwide

POSSIBLE FIELDS OF APPLICATION

- Water Supply
- Farming
- Washdown
- Construction Sites
- Pressure Washing
- General Landscape/ Turf Care
- Agricultural Spraying
- Home Gardening
- Chemical Fluid Transfer
- Ground Maintenance

ACCESSORIZE YOUR REEL :: pg 56

- O-Rings & Swivels
- Hoses
- Pin lock
- Garden Hose Kit
- Roller Bracket
- Assorted Reel Accessories
- Brawny upgrade

REEL DIMENSIONS

Technical Data Sheets Available On Website

SIZE INDEX	W	H	L	X	Y	M	N	Ø	Dw
1	14 1/2"	13"	12"	6"	6"	4"	3"	5 1/2"	4 1/2"
2	18 1/4"	13"	12"	9 1/2"	6"	5 1/2"	3"	5 1/2"	8"
3	22 3/4"	13"	12"	14"	6"	10"	3"	5 1/2"	12 1/2"
4	18 1/4"	18"	17"	9 1/2"	6"	5 1/2"	3"	5 1/2"	8"
5	22 3/4"	18"	17"	14"	6"	10"	3"	5 1/2"	12 1/2"
6	28 1/4"	18"	17"	19 1/2"	6"	15 1/2"	3"	5 1/2"	18"
7	23 1/4"	18"	17"	14"	6"	10"	3"	5 1/2"	12 1/2"

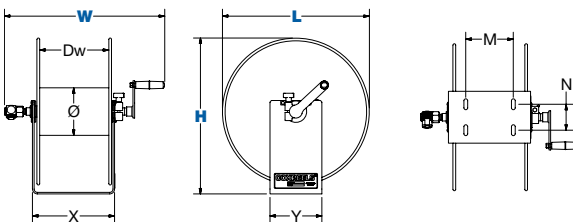

NEW UPGRADES



ROLLER BRACKETS

4-way enclosed pinch-proof stainless steel rollers are 1 in diameter supported by powder coated steel brackets. Weight: Add 10 lbs. to reel weight.



PINLOCK

The spring-loaded lock pin assembly is designed to lock & secure the reel, even in mobile conditions over rough terrain.



STRENGTHEN DRUM WITH BRAWNY OPTION

The Brawny feature closes the drum opening, increasing the drum strength to resist potential damage from hose constriction under increased or pulsing pressure usage

WARNING: Cancer and reproductive Harm – See page 22 for details.

3/8" - 1/2" I.D.

PORTABLE HOSE REELS **CM & DM SERIES**

COXREELS® CM Series "Caddy Mount" and DM Series "Dolly Mount" hand crank hose reels offer lightweight, compact portability for long lengths of hose. Eliminate the task of manually coiling and uncoiling hose and easily transport it to the job site on wheels. High pressure applications are no problem with a 4,000 PSI rating. Also, a 4" inlet hose with 3/4" female fitting and male garden adaptor is available with this series for use with garden hose. See options below.

PORTABLE HOSE REELS SERIES - ALL REELS SUPPLIED LESS HOSE

MODEL	LESS HOSE						PSI	APRX LBS.	SIZE INDEX
	STANDARD CAPACITY			OPTIONAL CAPACITY Reducer Required					
	I.D.	O.D.	FT.	I.D.	O.D.	FT.			
CM SERIES - CADDY MOUNT									
112-3-100-CM	3/8"	5/8"	100	1/4"	1/2"	150	4,000	18	1
112-3-150-CM	3/8"	5/8"	150	1/4"	1/2"	225	4,000	22	2
117-4-225-CM	1/2"	7/8"	225	3/8"	3/4"	315	4,000	28	3
DM SERIES - DOLLY MOUNT									
117-3-200-DM	3/8"	5/8"	200	1/4"	1/2"	350	4,000	37	4
117-4-225-DM	1/2"	7/8"	225	3/8"	3/4"	315	4,000	39	5

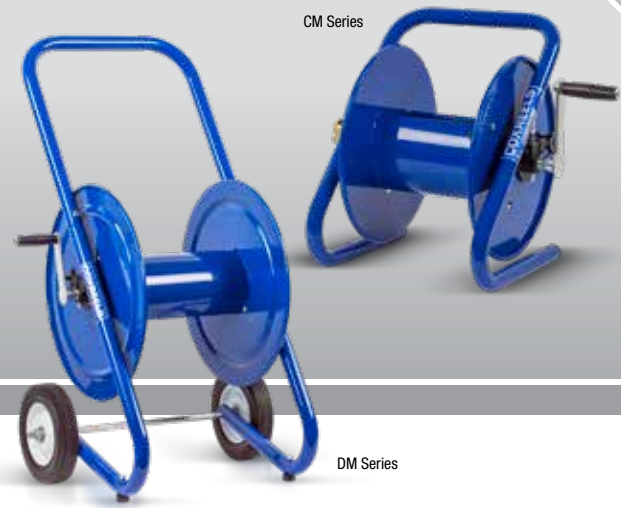

CM & DM SERIES :: REEL SPECIFICATIONS

SWIVEL

- Machined solid brass 90° full-flow NPT swivel inlet
- Swivel Seals: NITRILE
- Up to 4,000 PSI working pressure

CM SERIES DESIGN & STRUCTURE

- High quality one piece 1" steel tube frame structure
- Hose Control bar prevents hose from slipping off the discs
- Adjustable tension brake to prevent "free-wheeling"
- Base has holes for temporary or permanent installation

DM SERIES DESIGN & STRUCTURE

- High quality three piece 1 1/4" steel tube frame structure
- Solid 8" rubber tires for easy transport
- Rubber front feet prevent reel from slipping forward
- Removable handle allow for compact storage
- Adjustable tension brake to prevent "free-wheeling"

RETRACTION

- Direct hand crank rewind

SIGNATURE FEATURES

- Professional grade heavy duty steel construction
- Durable proprietary CPC™ powder coat process
- Rolled edges & ribbed discs provide strength & safety
- Leading 2-year manufacturer's limited warranty
- Made in the U.S.A. - Sold & Supported Worldwide

POSSIBLE FIELDS OF APPLICATION

- Water Supply
- Washdown
- Pressure Washing
- Agricultural Spraying
- Chemical Fluid Transfer
- Ground Maintenance
- Restaurants
- Construction Sites
- General Landscape/ Turf Care
- Home Gardening

ACCESSORIZE YOUR REEL :: Pg 56

- Mounting Brackets
- Assorted Reel Accessories
- Hoses
- Garden Hose Kit

REEL DIMENSIONS

Technical Data Sheets Available On Website

SIZE INDEX	W	H	L	X	Y	M	N	Ø	Dw
1	18 1/2"	14 3/4"	13 1/8"	11 1/2"	10 5/8"	10 1/2"	5 1/4"	5 1/2"	8"
2	23"	14 3/4"	13 1/8"	16"	10 1/2"	10 1/2"	5 1/4"	5 1/2"	12 1/2"
3	23"	18 1/2"	18"	16"	12 5/8"	10 1/2"	5 1/4"	5 1/2"	12 1/2"
4	19"	36 1/4"	21"	12"	17 1/2"	-	-	5 1/2"	8"
5	23 1/2"	36 1/4"	21"	16 1/2"	17 1/2"	-	-	5 1/2"	12 1/2"

Overall Dimensions Base Mounting Pattern Drum

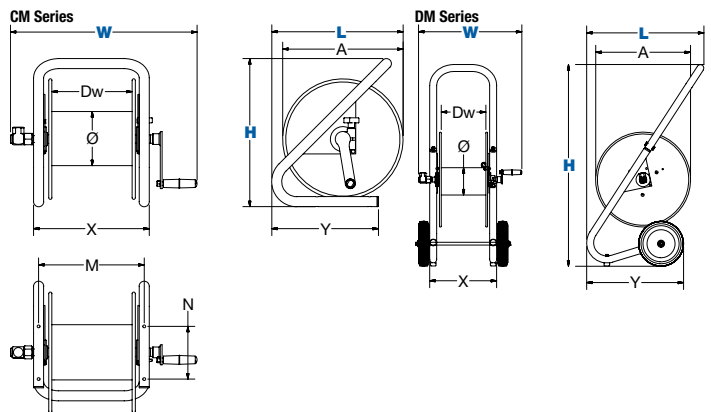

COXREELS® 1/2" HOSE ACCESSORY



Garden Hose Kit

You are able to connect any hose to a reel with 1/2" plumbing. You will be able to use any garden hose for everything from watering plants to washing your car. Kit includes: NPT to garden hose adaptor & adaptor hose #15717

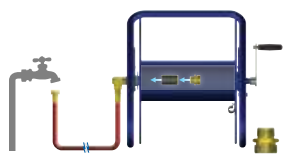

WARNING: Cancer and reproductive Harm – See page 22

3/8" - 1/2" I.D.

SM SERIES COMPACT SWIVEL MOUNT HOSE REELS



COXREELS® SM Series "Swivel Mount" hand crank hose reels swivel on demand in the direction your work takes you and locks in eight different positions as desired. Like the 100 Series, the SM Series is lightweight, compact and versatile with a working pressure up to 4,000 PSI. The "U" shaped base and hose control bar together add strength and rigidity while keeping the hose from slipping off the side discs. Add the SMK-202 wall mount bracket for swiveling mounted positions.

SM SERIES - ALL REELS SUPPLIED LESS HOSE

MODEL	LESS HOSE						PSI	APRX LBS.	SIZE INDEX
	STANDARD CAPACITY			OPTIONAL CAPACITY Reducer Required					
	I.D.	O.D.	FT.	I.D.	O.D.	FT.			
SM12-3-100	3/8"	5/8"	100	1/4"	1/2"	150	4,000	15	1
SM17-3-250	3/8"	5/8"	250	1/4"	1/2"	350	4,000	26	2
SM17-4-125	1/2"	7/8"	125	3/8"	3/4"	150	4,000	26	2

SM SERIES - REEL SPECIFICATIONS

SWIVEL

- Machined solid brass 90° full-flow NPT swivel inlet
- Swivel Seals: VITON®
- Up to 4,000 PSI working pressure

DESIGN & STRUCTURE

- Professional grade, swivel mount hand crank reel
- Forward-weighted design ensures rotation in direction of use
- Solid one piece, heavy gauge steel frame
- Unique hose control bar keeps hose from slipping off the disc from any direction
- Optional 8-position swivel mount wall mount bracket with lock pin
- Adjustable tension brake to prevent "free-wheeling" during operation, transport or storage
- Garden hose kit available, see accessories

RETRACTION

- Direct hand crank rewind

SIGNATURE FEATURES

- Professional grade heavy duty steel construction
- Durable proprietary CPC™ powder coat process
- Rolled edges & ribbed discs provide strength & safety
- Leading 2-year manufacturer's limited warranty
- Made in the U.S.A. - Sold & Supported Worldwide

POSSIBLE FIELDS OF APPLICATION

- Water Supply
- Ground Maintenance
- Washdown
- Farming
- Pressure Washing
- Construction Sites
- Agricultural Spraying
- General Landscape/ Turf Care
- Chemical Fluid Transfer
- Home Gardening
- Industrial Facilities Maintenance

ACCESSORIZE YOUR REEL :: PG 56

- O-Rings & Swivels
- Hoses
- Assorted Reel Accessories
- Garden Hose Kit

REEL DIMENSIONS

Technical Data Sheets Available On Website

SIZE INDEX	W	H	L	X	Y	M	N	Ø	Dw
1	19"	13 1/2"	12"	10 1/4"	4"	7"	3"	5 1/2"	8"
2	19"	18 1/2"	17"	10 1/4"	4"	7"	3"	5 1/2"	8"

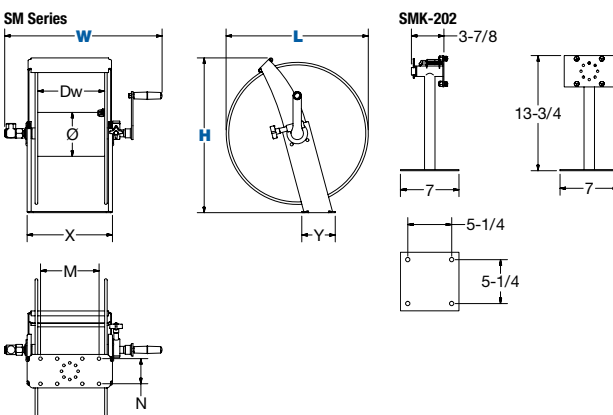

COXREELS® ACCESSORY



Mounting Bracket - Sold separately
Pivoting base for wall mounting only. Heavy gauge steel construction, powder coated crinkle black, Includes rigid arm with 8-position locking pivot base.
Weight: 8 lbs. **#SMK-202**



Tube Mounting Bracket - Sold separately
Pivoting base for tube mounting only. Heavy gauge steel construction, powder coated crinkle black, includes bent square tube arm with 8-position locking pivot base. Tube is 1 1/4" square 14 ga tube which slides into square tube receiver (Not Included). A favorite mounting method used by trailer and cart builders. **#SMK-502**

WARNING: Cancer and reproductive Harm – See page 22 of the Safety Manual

**COMPACT HAND CRANK HOSE,
CORD OR CABLE STORAGE REELS**

112Y SERIES

3/8" - 1/2" I.D.
8GA - 16GA

COXREELS® 112Y Series hand crank hose reels are lightweight, compact, versatile reels to store and maintain your hose or cord. Save time and effort while increasing the safety of your work environment. The standard 112Y reels feature a sturdy "U" shaped frame and all steel construction make this one tough little reel. The 112Y-CM reels have a high quality one piece 1" steel tube frame structure.

112Y SERIES - ALL REELS SUPPLIED LESS HOSE / CORD

MODEL	LESS HOSE / CORD				HOSE I.D.		APRX. LBS.	SIZE INDEX
	CABLE I.D.*				3/8"	1/2"		
	8/3	10/3	12/3	16/3				
112Y SERIES								
112Y-4	40	75	150	300	50	30	10	1
112Y-8	80	135	300	-	100	55	14	2
112Y-12	150	225	-	-	150	75	20	3
112Y-CM SERIES - CADDY MOUNT								
112Y-8-CM	80	135	300	-	100	55	13	4
112Y-12-CM	150	225	-	-	150	75	19	5

*Cable length based on SJ cord type



112Y-CM Series

112Y Series

112Y SERIES :: REEL SPECIFICATIONS

OPEN PORT

- Professional grade, compact & lightweight hand crank reels to store & maintain hose, cord, cable, wire, rope, tape, chain & more.
- Open drum design for no hassle hose wrap
- Open port for easy pass through for any type of hose, cord or cable
- Hose, cord or cable not included.

DESIGN & STRUCTURE

- Solid one piece 10GA steel "U" shaped frame
- Base has holes for temporary or permanent installation
- Adjustable tension brake to prevent "free-wheeling" during operation, transport or storage
- Control bar prevents hose, cord or cable from slipping off the discs
- (On 112Y-CM only) High quality one piece 1" steel tube frame structure
- (On 112Y-CM only) "Caddy Mount" offers convenient portability

RETRACTION

- Direct hand crank rewind

SIGNATURE FEATURES

- Professional grade heavy duty steel construction
- Durable proprietary CPC™ powder coat process
- Rolled edges & ribbed discs provide strength & safety
- Leading 2-year manufacturer's limited warranty
- Made in the U.S.A. - Sold & Supported Worldwide

POSSIBLE FIELDS OF APPLICATION

- Hose, Cord & Cable Storage
- Mobile or Stationary Units
- Residential/Commercial/Industrial Use

ACCESSORIZE YOUR REEL :: PG 56

- O-Rings & Swivels
- Hoses
- Assorted Reel Accessories

REEL DIMENSIONS Technical Data Sheets Available On Website

SIZE INDEX	W	H	L	X	Y	M	N	Ø	Dw
1	12 1/4"	13 1/8"	12"	6"	6"	4"	3"	5 1/2"	4 1/2"
2	15 3/4"	13 1/8"	12"	9 1/2"	6"	5 1/2"	3"	5 1/2"	8"
3	20 1/4"	13 1/8"	12"	14"	6"	10"	3"	5 1/2"	12 1/2"
4	16 3/8"	14 3/4"	13"	11 1/2"	10 5/8"	10 1/2"	5 1/4"	5 1/2"	8"
5	20 7/8"	14 3/4"	13"	16"	10 5/8"	15"	5 1/4"	5 1/2"	12 1/2"

Overall Dimensions Base Mounting Pattern Drum

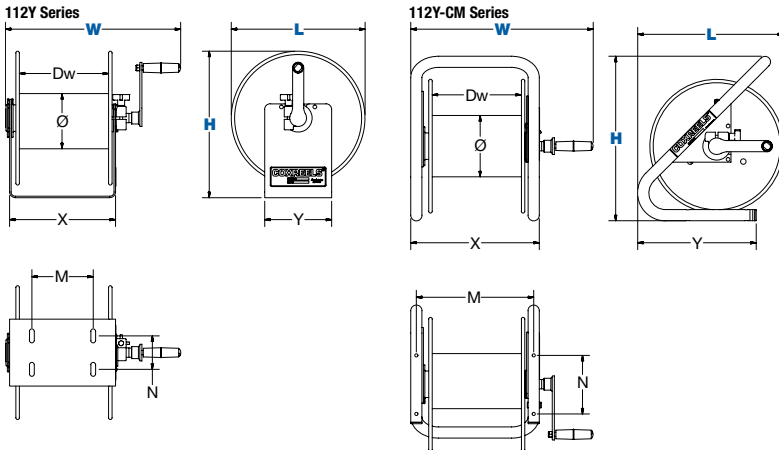

COXREELS® FEATURE

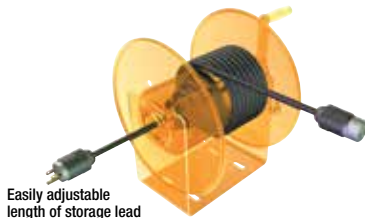

The access port & open drum allow for quick & easy use of hose cord or cable

The open drum & access port lets the hose/cord/cable quickly & easily pass thru to the center of the drum where it can be quickly wrapped up for easy storage.

WARNING: Cancer and reproductive Harm – See page 56

1/2" - 1" I.D.

1125 SERIES

HAND CRANK & MOTOR DRIVEN HOSE REELS

COXREELS® 1125 Series hand crank and motorized hose reels have the features demanded by industry professionals. The industry preferred design features a sturdy one piece all welded "A" frame base, low profile outlet riser and open drum slot design provides a non-crimping, flat smooth hose wrap.



1125 SERIES

- ALL REELS SUPPLIED LESS HOSE

MODEL	STANDARD CAP			OPTIONAL CAP. Reducer required			INLET SWIVEL & OUTLET RISER	PSI	MODEL	HP PSI	APRX. LBS.	SIZE INDEX
	I.D.	O.D.	FT.	I.D.	O.D.	FT.						
1125-4-100	1/2"	7/8"	100	3/8"	3/4"	140	1/2" F NPT	3,000	HP1125-4-100	5,000	36	1
1125-4-200	1/2"	7/8"	200	3/8"	3/4"	300	1/2" F NPT	3,000	HP1125-4-200	5,000	39	2
1125-4-325	1/2"	7/8"	325	3/8"	3/4"	450	1/2" F NPT	3,000	HP1125-4-325	5,000	48	3
1125-4-450	1/2"	7/8"	450	3/8"	3/4"	625	1/2" F NPT	3,000	HP1125-4-450	5,000	52	4
1125-4-500	1/2"	7/8"	500	3/8"	3/4"	700	1/2" F NPT	3,000	HP1125-4-500	5,000	58	5
1125-5-50	3/4"	1 1/4"	50	1/2"	7/8"	100	3/4" F NPT	3,000	HP1125-5-50	4,500	38	6
1125-5-100	3/4"	1 1/4"	100	1/2"	7/8"	200	3/4" F NPT	3,000	HP1125-5-100	4,500	42	7
1125-5-175	3/4"	1 1/4"	175	1/2"	7/8"	325	3/4" F NPT	3,000	HP1125-5-175	4,500	50	8
1125-5-200	3/4"	1 1/4"	200	1/2"	7/8"	450	3/4" F NPT	3,000	HP1125-5-200	4,500	55	9
1125-5-250	3/4"	1 1/4"	250	1/2"	7/8"	500	3/4" F NPT	3,000	HP1125-5-250	4,500	59	10
1125-6-35	1"	1 7/16"	35	3/4"	1 1/4"	50	1" F NPT	3,000	-	-	50	11
1125-6-50	1"	1 7/16"	50	3/4"	1 1/4"	75	1" F NPT	3,000	-	-	55	12
1125-6-75	1"	1 7/16"	75	3/4"	1 1/4"	120	1" F NPT	3,000	-	-	62	13
1125-6-100	1"	1 7/16"	100	3/4"	1 1/4"	150	1" F NPT	3,000	-	-	69	14

1125 SERIES :: REEL SPECIFICATIONS

SWIVEL

- Machined solid brass 90° full-flow NPT swivel
- External 90° full-flow NPT swivel with electroless nickel plated steel inlet (on high pressure HP & 1" steel models)
- Swivel Seals: NITRILE
AFLAS on 1" steel models
NITRILE on 1" stainless fluid path models
- Swivel Seals: AFLAS (on high pressure HP prefix models)

DESIGN & STRUCTURE

- All welded steel "A" frame construction for superior reel structure
- Exclusive low profile outlet riser & open drum slot design for flat smooth hose wrap
- Permanently lubricated self-aligning pillow block bearings for trouble-free & smooth rotation
- Adjustable tension brake to prevent "free-wheeling" during operation
- Long-handled locking pin to secure reel from rotation during transport or storage

RETRACTION

- Reliable direct gear drive on motor driven models providing quiet & smooth retraction - **NO CHAIN**
- Solid steel direct hand crank with smooth round handle
- See Motor Options Chart

SIGNATURE FEATURES

- Professional grade heavy duty steel construction
- Durable proprietary CPC™ powder coat process
- Rolled edges & ribbed discs provide strength & safety
- Leading 2-year manufacturer's limited warranty
- Made in the U.S.A. - Sold & Supported Worldwide

POSSIBLE FIELDS OF APPLICATION

- Industrial Plant & Ground Maintenance
- Fire Suppression
- Farming
- Construction Sites
- Landscape
- Pest & Weed Control
- Golf Course Maintenance
- Air Compressor
- Washdown
- High-Flow Watering
- Hydro Seeding
- Pressure Washing
- Agricultural Spraying
- Chemical Fluid Transfer

ACCESSORIZE YOUR REEL :: PG 56

- O-Rings & Swivels
- Roller Brackets
- Hoses
- Assorted Reel Accessories
- Stacking Brackets

WARNING: Cancer and reproductive Harm - See page 22

MOTOR OPTIONS

When ordering, suffix the model number with selection below. NOTE: Add 5 lbs to ship weight if reel is crated

SUFFIX	TYPE	DESCRIPTION	ADD ON APRX. LBS
A	AIR - 4 VANE	ALUMINUM BODY AIR MOTOR	8
AB	AIR - 6 VANE	CAST IRON AIR MOTOR	8
C	FRONT HAND CRANK	BEVEL GEARED CRANK	3
E	12 V DC, 1/3 HP	REVERSIBLE	13
ED	12 V DC, 1/2 HP EXP.	EXPLOSION PROOF, REVERSIBLE	26
EF	24 V DC, 1/3 HP	REVERSIBLE	13
EB	24 V DC, 1/2 HP EXP.	EXPLOSION PROOF, REVERSIBLE	26
EA	115 V AC, 1/2 HP EXP.	EXPLOSION PROOF REVERSIBLE AC RECTIFIED	26
EJ	230 V AC, 1/2 HP EXP.	EXPLOSION PROOF REVERSIBLE AC RECTIFIED	26
H	HYDRAULIC	END PORTED 9/16-18 UNF	6

REEL DIMENSIONS

Technical Data Sheets Available On Website

SIZE INDEX	W			H		L	X	Y		Ø	Dw
	CRANK	ELEC.	AIR / HYD.	CRANK	ELEC.			CRANK	ELEC.		
1	19 1/2"	19 3/4"	17"	18 3/4"	19 1/4"	17 5/8"	11 3/8"	15 3/8"	16"	6 1/4"	6"
2	25 1/2"	25 3/4"	23"	18 3/4"	19 1/4"	17 5/8"	17 3/8"	15 3/8"	16"	6 1/4"	12"
3	31 1/2"	31 3/4"	29"	18 3/4"	19 1/4"	17 5/8"	23 3/8"	15 3/8"	16"	6 1/4"	18"
4	37 1/2"	37 3/4"	35"	18 3/4"	19 1/4"	17 5/8"	29 3/8"	15 3/8"	16"	6 1/4"	24"
5	41 1/2"	41 3/4"	39"	18 3/4"	19 1/4"	17 5/8"	33 3/8"	15 3/8"	16"	6 1/4"	28"
6	20 3/4"	20"	17 3/8"	18 3/4"	19 1/4"	17 5/8"	11 3/8"	15 3/8"	16"	6 1/4"	6"
7	26 3/4"	26"	23 3/8"	18 3/4"	19 1/4"	17 5/8"	17 3/8"	15 3/8"	16"	6 1/4"	12"
8	32 3/4"	32"	29 3/8"	18 3/4"	19 1/4"	17 5/8"	23 3/8"	15 3/8"	16"	6 1/4"	18"
9	38 3/4"	38"	35 3/8"	18 3/4"	19 1/4"	17 5/8"	29 3/8"	15 3/8"	16"	6 1/4"	24"
10	42 3/4"	42"	39 3/8"	18 3/4"	19 1/4"	17 5/8"	33 3/8"	15 3/8"	16"	6 1/4"	28"
11	26"	23 7/8"	22 1/4"	18 1/2"	19 1/8"	17 5/8"	14 7/8"	15 3/8"	16"	8 1/4"	9 1/2"
12	32"	29 7/8"	28 1/4"	18 1/2"	19 1/8"	17 5/8"	20 7/8"	15 3/8"	16"	8 1/4"	15 1/2"
13	38 1/2"	36 3/8"	34 3/4"	18 1/2"	19 1/8"	17 5/8"	27 3/8"	15 3/8"	16"	8 1/4"	22"
14	44 1/2"	42 3/8"	40 3/4"	18 1/2"	19 1/8"	17 5/8"	33 3/8"	15 3/8"	16"	8 1/4"	28"

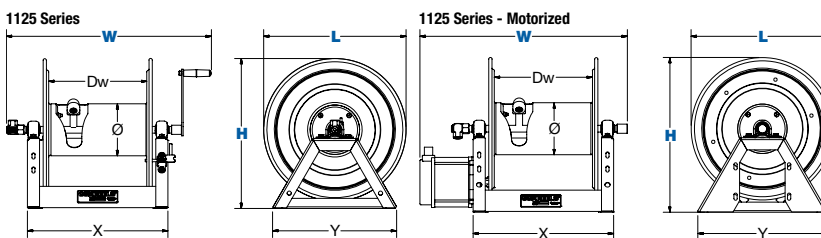

COXREELS® 1175 Series hand crank and motorized hose reels, like the 1125 Series, is an industry preferred design built with a larger chassis for larger hose capacities and hose diameters. They feature a sturdy one piece all welded "A" frame base, low profile outlet riser open drum slot design for smooth even hose wraps around the drum.

1175 SERIES - ALL REELS SUPPLIED LESS HOSE

MODEL	STANDARD CAP			OPTIONAL CAP. Reducer required			INLET SWIVEL ASSEMBLY	OUTLET RISER	PSI	APRX. LBS.	SIZE INDEX
	I.D.	O.D.	FT.	I.D.	O.D.	FT.					
1175-6-50	1"	17/16"	50	3/4"	1 1/4"	100	1" F NPT 90°	1" F NPT	3,000	67	1
1175-6-100	1"	17/16"	100	3/4"	1 1/4"	150	1" F NPT 90°	1" F NPT	3,000	70	2
1175-6-125	1"	17/16"	125	3/4"	1 1/4"	200	1" F NPT 90°	1" F NPT	3,000	72	3
1175-6-135	1"	17/16"	135	3/4"	1 1/4"	175	1" F NPT 90°	1" F NPT	3,000	70	6
1175-6-150	1"	17/16"	150	3/4"	1 1/4"	250	1" F NPT 90°	1" F NPT	3,000	75	4
1175-6-200	1"	17/16"	200	3/4"	1 1/4"	300	1" F NPT 90°	1" F NPT	3,000	83	5



MOTOR OPTIONS When ordering, suffix the model number with selection below. NOTE: Add 5 lbs to ship weight if reel is crated

SUFFIX	TYPE	DESCRIPTION	ADD ON APRX. LBS
A	AIR - 4 VANE	ALUMINUM BODY AIR MOTOR	8
AB	AIR - 6 VANE	CAST IRON AIR MOTOR	8
C	FRONT HAND CRANK	BEVEL GEARED CRANK	3
E	12 V DC, 1/3 HP	REVERSIBLE	13
ED	12 V DC, 1/2 HP EXP.	EXPLOSION PROOF, REVERSIBLE	26
EF	24 V DC, 1/3 HP	REVERSIBLE	13
EB	24 V DC, 1/2 HP EXP.	EXPLOSION PROOF, REVERSIBLE	26
EA	115 V AC, 1/2 HP EXP.	EXPLOSION PROOF REVERSIBLE AC RECTIFIED	26
EJ	230 V AC, 1/2 HP EXP.	EXPLOSION PROOF REVERSIBLE AC RECTIFIED	26
H	HYDRAULIC	END PORTED 3/16-18 UNF	6

REEL DIMENSIONS Technical Data Sheets Available On Website

SIZE INDEX	W		H		L	X	Y	Ø	Dw	
	CRANK	ELEC.	AIR / HYD.	CRANK						ELEC.
1	24 1/8"	22"	20 1/2"	26 1/8"	26 1/8"	24"	13"	20 1/8"	10 1/2"	7 1/2"
2	28 1/8"	26"	24 1/2"	26 1/8"	26 1/8"	24"	17"	20 1/8"	10 1/2"	11 1/2"
3	30 1/8"	28"	26 1/2"	26 1/8"	26 1/8"	24"	19"	20 1/8"	10 1/2"	13 1/2"
4	32 1/8"	30"	28 1/2"	26 1/8"	26 1/8"	24"	21"	20 1/8"	10 1/2"	15 1/2"
5	36 5/8"	34 1/2"	33"	26 1/8"	26 1/8"	24"	25 1/2"	20 1/8"	10 1/2"	20"
6	36 5/8"	34 1/2"	33"	22"	22 7/8"	20"	25 1/2"	18 1/8"	10 1/2"	20"

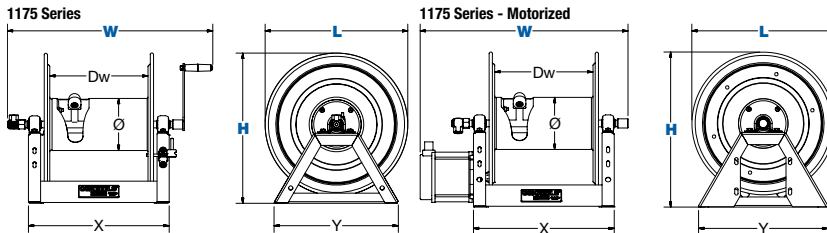

1175 SERIES :: REEL SPECIFICATIONS

SWIVEL

- Nickel plated steel 90° full-flow NPT swivel inlet
- Swivel Seals: AFLAS NITRILE on stainless steel fluid path
- Available with stainless steel 304 fluid path

DESIGN & STRUCTURE

- All welded steel "A" frame construction for superior reel structure
- Exclusive low profile outlet riser & open drum slot design for flat smooth hose wrap
- Permanently lubricated self-aligning pillow block bearings for trouble-free & smooth rotation
- Adjustable tension brake to prevent "free-wheeling" during operation
- Long-handled locking pin to secure reel from rotation during transport or storage

RETRACTION

- Reliable chain & sprocket drive on motor driven models
- Solid steel direct hand crank with smooth round handle
- See Motor Options Chart

SIGNATURE FEATURES

- Professional grade heavy duty steel construction
- Durable proprietary CPC™ powder coat process
- Rolled edges & ribbed discs provide strength & safety
- Leading 2-year manufacturer's limited warranty
- Made in the U.S.A. - Sold & Supported Worldwide

POSSIBLE FIELDS OF APPLICATION

- Water Trucks
- Construction Sites
- Fire Suppression
- Chemical Fluid Transfer
- Lubricant Dispensing
- Farming
- High-Flow Watering
- Chemical Fluid Transfer

ACCESSORIZE YOUR REEL :: pg 56

- O-Rings & Swivels
- Roller Brackets
- Hoses
- Assorted Reel Accessories



WARNING: Cancer and reproductive Harm – See page 56

1 1/2" I.D.

1185 SERIES

LARGE CAPACITY/VOLUME HOSE REELS

COXREELS® 1185 Series hand crank and motor driven hose reels are designed to handle long lengths of large diameter hose for increased volume delivery. Coxreels' exclusive low profile outlet riser and open drum design provide a noncrimping, flat smooth hose wrap. The sturdy all welded "A" frame base provides exceptional strength to handle the extra weight without sacrificing performance, even in demanding mobile applications.

1185 SERIES

- ALL REELS SUPPLIED LESS HOSE

MODEL	STANDARD CAP			OPTIONAL CAP. Reducer required			INLET SWIVEL & OUTLET RISER	PSI	APRX. LBS.	SIZE INDEX
	I.D.	O.D.	FT.	I.D.	O.D.	FT.				
1185 SERIES - IN-LINE SWIVEL										
1185-1124	1 1/2"	2 1/16"	50	1 1/4"	1 13/16"	75	1 1/2" F NPT	1,500	76	1
1185-1524	1 1/2"	2 1/16"	75	1 1/4"	1 13/16"	100	1 1/2" F NPT	1,500	81	2
1185-2020	1 1/2"	2 1/16"	70	1 1/4"	1 13/16"	80	1 1/2" F NPT	1,500	70	3
1185-2024	1 1/2"	2 1/16"	100	1 1/4"	1 13/16"	125	1 1/2" F NPT	1,500	94	4
1185-2028	1 1/2"	2 1/16"	125	1 1/4"	1 13/16"	180	1 1/2" F NPT	1,500	109	5
1185-2528	1 1/2"	2 1/16"	150	1 1/4"	1 13/16"	220	1 1/2" F NPT	1,500	122	6
1185-3324	1 1/2"	2 1/16"	175	1 1/4"	1 13/16"	225	1 1/2" F NPT	1,500	154	7
1185-3328	1 1/2"	2 1/16"	250	1 1/4"	1 13/16"	325	1 1/2" F NPT	1,500	169	8
1185 SERIES - 90° SWIVEL										
1185-1124-BUXX	1 1/2"	2 1/16"	50	1 1/4"	1 13/16"	75	1 1/2" F NPT	3,000	76	1
1185-1524-BUXX	1 1/2"	2 1/16"	75	1 1/4"	1 13/16"	100	1 1/2" F NPT	3,000	81	2
1185-2020-BUXX	1 1/2"	2 1/16"	70	1 1/4"	1 13/16"	80	1 1/2" F NPT	3,000	70	3
1185-2024-BUXX	1 1/2"	2 1/16"	100	1 1/4"	1 13/16"	125	1 1/2" F NPT	3,000	94	4
1185-2028-BUXX	1 1/2"	2 1/16"	125	1 1/4"	1 13/16"	180	1 1/2" F NPT	3,000	109	5
1185-2528-BUXX	1 1/2"	2 1/16"	150	1 1/4"	1 13/16"	220	1 1/2" F NPT	3,000	122	6
1185-3324-BUXX	1 1/2"	2 1/16"	175	1 1/4"	1 13/16"	225	1 1/2" F NPT	3,000	154	7
1185-3328-BUXX	1 1/2"	2 1/16"	250	1 1/4"	1 13/16"	325	1 1/2" F NPT	3,000	169	8

MOTOR OPTIONS

When ordering, suffix the model number with selection below. NOTE: Add 5 lbs to ship weight if reel is crated

SUFFIX	TYPE	DESCRIPTION	ADD ON APRX. LBS
A	AIR - 4 VANE	ALUMINUM BODY AIR MOTOR	8
AB	AIR - 6 VANE	CAST IRON AIR MOTOR	8
C	FRONT HAND CRANK	BEVEL GEARED CRANK	3
E	12 V DC, 1/3 HP	REVERSIBLE	13
ED	12 V DC, 1/2 HP EXP.	EXPLOSION PROOF, REVERSIBLE	26
EF	24 V DC, 1/3 HP	REVERSIBLE	13
EB	24 V DC, 1/2 HP EXP.	EXPLOSION PROOF, REVERSIBLE	26
EA	115 V AC, 1/2 HP EXP.	EXPLOSION PROOF REVERSIBLE AC RECTIFIED	26
EJ	230 V AC, 1/2 HP EXP.	EXPLOSION PROOF REVERSIBLE AC RECTIFIED	26
H	HYDRAULIC	END PORTED 9/16-18 UNF	6

REEL DIMENSIONS

Technical Data Sheets Available On Website

SIZE INDEX	W				H	L	X	Y	Ø	Dw
	CRANK	ELEC.	AIR / HYD.	-BUXX EQUIPPED						
1	25"	26 1/8"	23 3/8"	26 7/8"	26"	24"	17"	22 1/4"	10 1/2"	11 1/2"
2	29"	30 1/8"	27 3/8"	30 7/8"	26"	24"	21"	22 1/4"	10 1/2"	15 1/2"
3	33 1/2"	34 5/8"	31 7/8"	35 3/8"	21 5/8"	20"	25 1/2"	19 5/8"	10 1/2"	20"
4	33 1/2"	34 5/8"	31 7/8"	35 3/8"	26"	24"	25 1/2"	22 1/4"	10 1/2"	20"
5	33 1/2"	34 5/8"	31 7/8"	35 3/8"	30"	28"	25 1/2"	24 1/2"	10 1/2"	20"
6	38 1/2"	39 5/8"	36 7/8"	40 3/8"	30"	28"	30 1/2"	24 1/2"	10 1/2"	25"
7	46 1/2"	47 5/8"	44 7/8"	48 3/8"	26"	24"	38 1/2"	22 1/4"	10 1/2"	33"
8	46 1/2"	47 5/8"	44 7/8"	48 3/8"	30"	28"	38 1/2"	24 1/2"	10 1/2"	33"

Overall Dimensions Base Drum

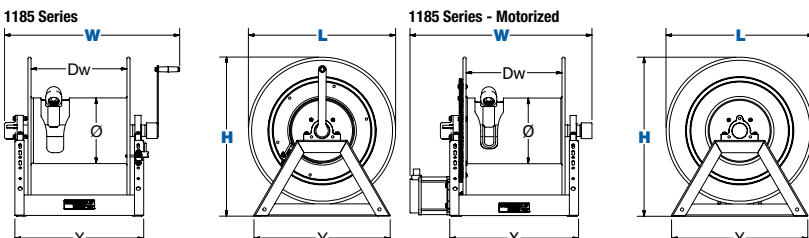

1185-EA In-Line Swivel Series

1185 90° Swivel Series

1185 SERIES :: REEL SPECIFICATIONS

SWIVEL

- In-line electroless nickel plated steel full-flow NPT swivel inlet
- Swivel Seals: NITRILE
- (On high pressure models with suffix -BUXX) External fluid path with electroless nickel plated steel 90° full-flow NPT swivel inlet
- (On high pressure models with suffix -BUXX) Swivel Seals: AFLAS
- Available with stainless steel fluid path

DESIGN & STRUCTURE

- All welded steel "A" frame construction for superior reel structure
- Exclusive low profile outlet riser & open drum slot design for flat smooth hose wrap
- Robust lubricated horizontal surface mount bearings for easy rotation
- (On hand crank models) Long-handled locking pin to secure reel from rotation during transport or storage

RETRACTION

- Reliable chain & sprocket drive on motor driven models
- Solid steel direct hand crank with smooth round handle
- See Motor Options Chart

SIGNATURE FEATURES

- Professional grade heavy duty steel construction
- Durable proprietary CPC™ powder coat process
- Rolled edges & ribbed discs provide strength & safety
- Leading 2-year manufacturer's limited warranty
- Made in the U.S.A. - Sold & Supported Worldwide

POSSIBLE FIELDS OF APPLICATION

- High Volume Delivery
- Bulk Liquid Handling
- Water Trucks
- Mining Operations
- Construction Sites
- Farming
- Chemical Fluid Transfer
- Aviation Refueling
- Fuel Trucks

ACCESSORIZE YOUR REEL :: PG 56

- O-Rings & Swivels
- Rolling Brackets
- Assorted Reel Accessories
- Hoses
- Brake

WARNING: Cancer and reproductive Harm - See page 22

COXREELS® 1195 Series motor driven hose reels are designed to handle long lengths of large diameter hose for increased volume delivery. Coxreels' exclusive low profile outlet riser and open drum design provide a noncrimping, flat smooth hose wrap. The sturdy all welded "A" frame base provides exceptional strength to handle the extra weight without sacrificing performance, even in demanding mobile applications.

1195 SERIES

- ALL REELS SUPPLIED LESS HOSE

MODEL	LESS HOSE										SIZE INDEX
	STANDARD CAP			OPTIONAL CAP. Reducer required			INLET SWIVEL ASSEMBLY	OUTLET RISER	PSI	APRX. LBS.	
	I.D.	O.D.	FT.	I.D.	O.D.	FT.					
STANDARD 1195 SERIES WITH IN-LINE SWIVEL											
1195-932-X	2"	29 1/16"	50	1 1/2"	2 1/16"	60	2" F NPT	2" F NPT	1,000	128	1
1195-1728-X	2"	29 1/16"	60	1 1/2"	2 1/16"	85	2" F NPT	2" F NPT	1,000	134	2
1195-1332-X	2"	29 1/16"	75	1 1/2"	2 1/16"	100	2" F NPT	2" F NPT	1,000	148	3
1195-2428-X	2"	29 1/16"	90	1 1/2"	2 1/16"	135	2" F NPT	2" F NPT	1,000	169	4
1195-2032-X	2"	29 1/16"	115	1 1/2"	2 1/16"	150	2" F NPT	2" F NPT	1,000	186	5
1195-3228-X	2"	29 1/16"	125	1 1/2"	2 1/16"	175	2" F NPT	2" F NPT	1,000	218	6
1195 SERIES WITH 90° SWIVEL											
1195-932-X-BUXX	2"	29 1/16"	50	1 1/2"	2 1/16"	60	2" F NPT	2" F NPT	1,500	128	1
1195-1728-X-BUXX	2"	29 1/16"	60	1 1/2"	2 1/16"	85	2" F NPT	2" F NPT	1,500	134	2
1195-1332-X-BUXX	2"	29 1/16"	75	1 1/2"	2 1/16"	100	2" F NPT	2" F NPT	1,500	148	3
1195-2428-X-BUXX	2"	29 1/16"	90	1 1/2"	2 1/16"	135	2" F NPT	2" F NPT	1,500	169	4
1195-2032-X-BUXX	2"	29 1/16"	115	1 1/2"	2 1/16"	150	2" F NPT	2" F NPT	1,500	186	5
1195-3228-X-BUXX	2"	29 1/16"	125	1 1/2"	2 1/16"	175	2" F NPT	2" F NPT	1,500	218	6

- SUFFIX "X" OPTIONS

These models are not available in direct hand crank models. When ordering, substitute the "X" with selection below. NOTE: Add 5 lbs to ship weight if reel is crated.

SUFFIX	TYPE	DESCRIPTION	ADD ON APRX. LBS
AB	AIR - 6 VANE	CAST IRON AIR MOTOR	8
C	FRONT HAND CRANK	BEVEL GEARED CRANK	3
EDV3	12 V DC, 1/2 HP EXP. 1:3	EXPLOSION PROOF, REVERSIBLE, IDLER	26
EBV3	24 V DC, 1/2 HP EXP. 1:3	EXPLOSION PROOF, REVERSIBLE, IDLER	26
EAV3	115 V AC, 1/2 HP EXP. 1:3	EXPLOSION PROOF REVERSIBLE AC RECTIFIED, IDLER	26
EJV3	230 V AC, 1/2 HP EXP. 1:3	EXPLOSION PROOF REVERSIBLE AC RECTIFIED, IDLER	26
H	HYDRAULIC	END PORTED 9/16-18 UNF	6

*Electric Rewind models are available without idler gears for use with electronic speed reducers, contact factory

REEL DIMENSIONS

Technical Data Sheets Available On Website

SIZE INDEX	W				H	L	X	Y	Ø	Dw
	CRANK	ELEC.	AIR / HYD.	-BUXX EQUIPPED						
1	17 7/8"	22 1/8"	19 3/8"	23"	33 1/4"	32"	15"	25 5/8"	15 1/2"	9 1/2"
2	25 7/8"	30 1/8"	27 3/8"	31"	30 1/4"	28"	23"	24 1/2"	15 1/2"	17 1/2"
3	21 7/8"	26 1/8"	23 3/8"	27"	33 1/4"	32"	19"	25 5/8"	15 1/2"	13 1/2"
4	32 3/8"	36 5/8"	33 3/8"	37 1/2"	30 1/4"	28"	29 1/2"	24 1/2"	15 1/2"	24"
5	28 3/8"	32 5/8"	29 7/8"	33 1/2"	33 1/4"	32"	25 1/2"	25 5/8"	15 1/2"	20"
6	40 3/8"	44 5/8"	41 7/8"	45 1/2"	30 1/4"	28"	37 1/2"	24 1/2"	15 1/2"	32"

Overall Dimensions Base Drum

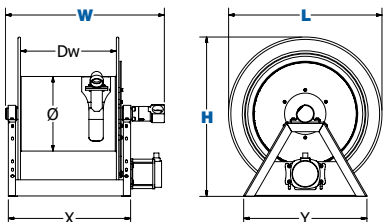

1195 SERIES :: REEL SPECIFICATIONS

SWIVEL

- In-line electroless nickel plated steel full-flow NPT swivel
- Swivel Seals: NITRILE
- (On high pressure models with suffix -BUXX) External fluid path with electroless nickel plated steel 90° full-flow NPT swivel
- (On high pressure models with suffix -BUXX) Swivel Seals: AFLAS
- Available with stainless steel fluid path

DESIGN & STRUCTURE

- All welded steel "A" frame construction for superior reel structure
- Exclusive low profile outlet riser & open drum slot design for flat smooth hose wrap
- Robust lubricated horizontal surface mount bearings for easy rotation
- Adaptor for Victaulic connections available, consult factory

RETRACTION

- Reliable chain & sprocket drive on motor driven models
- Idler Gears on electric rewind models to reduce drum speed and increase torque. Default ratio: 1:3. Available in three sizes, consult factory.
- (On models with suffix -C) Bevel geared crank rewind See Motor Options Chart

SIGNATURE FEATURES

- Professional grade heavy duty steel construction
- Durable proprietary CPC™ powder coat process
- Rolled edges & ribbed discs provide strength & safety
- Leading 2-year manufacturer's limited warranty
- Made in the U.S.A. - Sold & Supported Worldwide

POSSIBLE FIELDS OF APPLICATION

- High Volume Delivery
- Bulk Liquid Handling
- Water Trucks
- Mining Operations
- Construction Sites
- Farming
- Chemical Fluid Transfer
- Aviation Refueling
- Fuel Trucks

ACCESSORIZE YOUR REEL :: PG 56

- O-Rings & Swivels
- Roller Brackets
- Assorted Reel Accessories
- Hoses
- Brake

WARNING: Cancer and reproductive Harm – See page 56

1" I.D.

1600 SERIES

HAND CRANK & MOTORIZED HYBRID FRAME HOSE REELS



1600 Series with optional universal bracket kit, 4-way roller bracket, crank handler holster & bevel gear crank

COXREELS® 1600 Series features the most versatile symmetric reel design in the market today. This feature-rich reel series is the most versatile in the marketplace and features nearly endless component configurations on a robust platform for any conceivable application. Targeted for the tough demands of customers requiring various dimensional choices, the series offers flexible size envelopes for any given hose capacity. The 1600 series hybrid frame offers unique accessories and upgrades which allow for application tailoring resulting in enhanced performance and usability.

1660 MODELS - 4000 PSI - ALL REELS SUPPLIED LESS HOSE

MODEL	Hose Cap. 1" I.D.	Optional Hose Cap. 3/4" I.D.	DIMENSIONS							APRX. LBS	
			DW	L	W			H	X		Y
			DRUM WIDTH	DISC SIZE	CRANK	ELEC.	AIR/HYD.				
1660-0820	50'	60'	8"	20"	23 7/8"	21 5/8"	20 3/8"	21 3/4"	15"	20 1/4"	54
1660-1120	75'	100'	11.5"	20"	27 3/8"	25 1/8"	23 7/8"	21 3/4"	18 1/2"	20 1/4"	60
1660-0824			8"	24"	23 7/8"	21 5/8"	20 3/8"	25 1/4"	15"	23 1/4"	67
1660-1520	100'	150'	15.5"	20"	31 3/8"	29 1/8"	27 7/8"	21 3/4"	22 1/2"	20 1/4"	68
1660-0924			9.5"	24"	35 3/8"	23 1/8"	21 7/8"	25 1/4"	16 1/2"	23 1/4"	72
1660-2020	130'	175'	20"	20"	35 7/8"	33 3/8"	32 3/8"	21 3/4"	27"	20 1/4"	82
1660-1124			11.5"	24"	27 3/8"	25 1/8"	23 7/8"	25 1/4"	18 1/2"	23 1/4"	73
1660-0828			8"	28"	23 7/8"	21 5/8"	20 3/8"	29 1/4"	15"	26 1/4"	82
1660-2220			22"	20"	37 7/8"	35 5/8"	34 3/8"	21 3/4"	29"	20 1/4"	89
1660-1524	165'	225'	15.5"	24"	31 3/8"	29 1/8"	27 7/8"	25 1/4"	22 1/2"	23 1/4"	81
1660-0928			9.5"	28"	25 3/8"	23 1/8"	21 7/8"	29 1/4"	16 1/2"	26 1/4"	85
1660-2820	200'	275'	28"	20"	43 7/8"	41 5/8"	40 3/8"	21 3/4"	35"	20 1/4"	94
1660-2024			20"	24"	35 7/8"	33 3/8"	32 3/8"	25 1/4"	27"	23 1/4"	91
1660-1128			11.5"	28"	27 3/8"	25 1/8"	23 7/8"	29 1/4"	18 1/2"	26 1/4"	88
1660-2224	225'	325'	22"	24"	37 7/8"	35 5/8"	34 3/8"	25 1/4"	29"	23 1/4"	98
1660-1328			13.5"	28"	29 3/8"	27 1/8"	25 7/8"	29 1/4"	20 1/2"	26 1/4"	108
1660-3320	250'	375'	33"	20"	48 7/8"	46 5/8"	45 3/8"	21 3/4"	40"	20 1/4"	104
1660-2424			24"	24"	39 7/8"	37 5/8"	36 3/8"	25 1/4"	31"	23 1/4"	102
1660-1528			15.5"	28"	31 3/8"	29 1/8"	27 7/8"	29 1/4"	22 1/2"	26 1/4"	96
1660-2824	300'	450'	28"	24"	43 7/8"	41 5/8"	40 3/8"	25 1/4"	35"	23 1/4"	107
1660-3324			33"	24"	48 7/8"	46 5/8"	45 3/8"	25 1/4"	40"	23 1/4"	117
1660-2028	350'	500'	20"	28"	35 7/8"	33 3/8"	32 3/8"	29 1/4"	27"	26 1/4"	106
1660-2228			22"	28"	37 7/8"	35 5/8"	34 3/8"	29 1/4"	29"	26 1/4"	112
1660-2428	450'	600'	24"	28"	39 7/8"	37 5/8"	36 3/8"	29 1/4"	31"	26 1/4"	114

1660 MODEL :: REEL SPECIFICATIONS

SWIVEL

- Nickel plated steel 90° full-flow NPT swivel inlet
- Swivel Seals: NITRILE
- Available with stainless steel 304 or 316 fluid path

DESIGN & STRUCTURE

- All welded hybrid frame with added bolts
- Exclusive low profile outlet riser & open drum slot design for flat smooth hose wrap
- Permanently lubricated self-aligning pillow block bearings for trouble-free & smooth rotation
- Adjustable tension brake to prevent "free-wheeling" during operation
- (On hand crank models) Long-handled locking pin to secure reel from rotation during transport or storage

RETRACTION

- Reliable chain & sprocket drive on motor driven models
- Solid steel direct hand crank with smooth round handle
- All metal bevel crank and gear construction
- See Motor Options Chart

SIGNATURE FEATURES

- Professional grade heavy duty steel construction
- Durable proprietary CPC™ powder coat process
- Rolled edges & ribbed discs provide strength & safety
- Leading 2-year manufacturer's limited warranty
- Made in the U.S.A. - Sold & Supported Worldwide

POSSIBLE FIELDS OF APPLICATION

- High-flow Watering
- Fire Apparatus
- Chemical Fluid Transfer
- Mining Operations
- Construction Vehicles
- Water Trucks
- Bulk Liquid Handling
- OEM Systems

ACCESSORIZE YOUR REEL :: PG 56

- O-Rings & Swivels
- Roller Brackets & Crank
- Centrifugal Clutches
- 3 Way Brakes
- Speed Reducing Idler Sprockets
- 3 Way Pin Lock
- Rewind Actuators
- Crank Handle Holders
- Multi-angle Payouts
- Chain Guards

MOTOR OPTIONS

When ordering, suffix the model number with selection below. NOTE: Add 5 lbs to ship weight if reel is crated

SUFFIX	TYPE	DESCRIPTION	ADD ON APRX. LBS
A	AIR - 4 VANE	ALUMINUM BODY AIR MOTOR	8
AB	AIR - 6 VANE	CAST IRON AIR MOTOR	8
C	FRONT HAND CRANK	BEVEL GEARED CRANK	3
E	12 V DC, 1/3 HP	REVERSIBLE	13
ED	12 V DC, 1/2 HP EXP.	EXPLOSION PROOF, REVERSIBLE	26
EF	24 V DC, 1/3 HP	REVERSIBLE	13
EB	24 V DC, 1/2 HP EXP.	EXPLOSION PROOF, REVERSIBLE	26
EA	115 V AC, 1/2 HP EXP.	EXPLOSION PROOF REVERSIBLE AC RECTIFIED	26
EJ	230 V AC, 1/2 HP EXP.	EXPLOSION PROOF REVERSIBLE AC RECTIFIED	26
H	HYDRAULIC	END PORTED 9/16-18 UNF	6

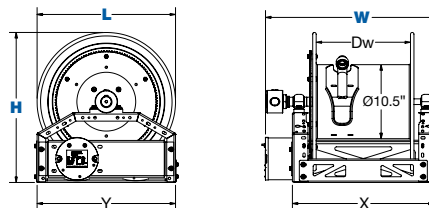

Go online to download the 1600 Brochure for more info at www.COXREELS.com

WARNING: Cancer and reproductive Harm - See page 22 of MSDS

COXREELS® 1600 Series features the most versatile symmetric reel design in the market today. This feature-rich reel series is the most versatile in the marketplace and features nearly endless component configurations on a robust platform for any conceivable application. Targeted for the tough demands of customers requiring various dimensional choices, the series offers flexible size envelopes for any given hose capacity. The 1600 series hybrid frame offers unique accessories and upgrades which allow for application tailoring resulting in enhanced performance and usability.

1680 MODELS - 1500 PSI

- ALL REELS SUPPLIED LESS HOSE

MODEL	Hose Cap. 1 1/2" I.D.	Optional Hose Cap. 1 1/4" I.D.	LESS HOSE DIMENSIONS								APRX. LBS
			DW	L	W			H	X	Y	
			DRUM WIDTH	DISC SIZE	CRANK	ELEC.	AIR/ HYD.				
1680-1120	35'	40'	11.5"	20"	24 7/8"	25 1/8"	23 7/8"	21 3/4"	18 1/2"	20 1/4"	60
1680-0824			8"	24"	21 3/8"	21 5/8"	20 3/8"	25 1/4"	15"	23 1/4"	67
1680-1520	50'	55'	15.5"	20"	28 7/8"	29 1/8"	27 7/8"	21 3/4"	22 1/2"	20 1/4"	68
1680-1124			11.5"	24"	24 7/8"	25 1/8"	23 7/8"	25 1/4"	18 1/2"	23 1/4"	73
1680-0828	70'	85'	8"	28"	21 3/8"	21 5/8"	20 3/8"	29 1/4"	15"	26 1/4"	82
1680-2220			22"	20"	35 3/8"	35 5/8"	34 3/8"	21 3/4"	29"	20 1/4"	82
1680-1324	85'	100'	13.5"	24"	26 7/8"	27 1/8"	25 7/8"	25 1/4"	20 1/2"	23 1/4"	77
1680-0928			9.5"	28"	22 7/8"	23 1/8"	21 7/8"	29 1/4"	16 1/2"	26 1/4"	84
1680-1524	100'	130'	15.5"	24"	28 7/8"	29 1/8"	27 7/8"	25 1/4"	22 1/2"	23 1/4"	81
1680-1128			11.5"	28"	24 7/8"	25 1/8"	23 7/8"	29 1/4"	18 1/2"	26 1/4"	88
1680-2024	125'	145'	20"	24"	33 3/8"	33 5/8"	32 3/8"	25 1/4"	27"	23 1/4"	91
1680-1328			13.5"	28"	26 7/8"	27 1/8"	25 7/8"	29 1/4"	20 1/2"	26 1/4"	92
1680-2224	150'	175'	22"	24"	35 3/8"	35 5/8"	34 3/8"	25 1/4"	29"	23 1/4"	95
1680-1528			15.5"	28"	28 7/8"	29 1/8"	27 7/8"	29 1/4"	22 1/2"	26 1/4"	96
1680-2028	200'	275'	20"	28"	33 3/8"	33 5/8"	32 3/8"	29 1/4"	27"	26 1/4"	106
1680-2824			28"	24"	41 3/8"	41 5/8"	40 3/8"	25 1/4"	35"	23 1/4"	107
1680-3324	275'	350'	33"	24"	46 3/8"	46 5/8"	45 3/8"	25 1/4"	40"	23 1/4"	117
1680-2428			24"	28"	37 3/8"	37 5/8"	36 3/8"	29 1/4"	31"	26 1/4"	114
1680-3328			33"	28"	46 3/8"	46 5/8"	45 3/8"	29 1/4"	40"	26 1/4"	132

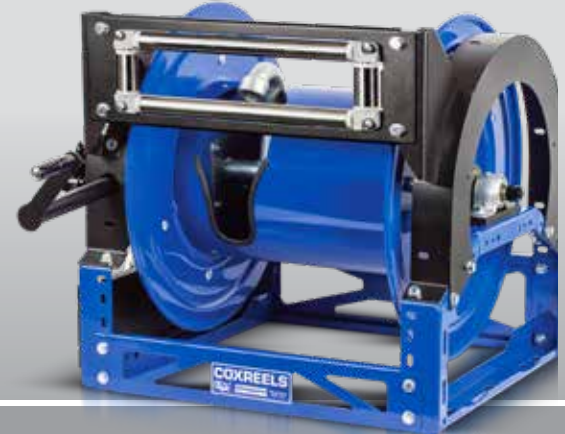

1600 Series with optional universal bracket kit, 4-way roller bracket, crank handler holster & bevel gear crank

1680 MODEL :: REEL SPECIFICATIONS

SWIVEL

- In-line nickel plated steel full-flow NPT swivel inlet
- Swivel Seals: NITRILE
- Available with stainless steel 304 or 316 fluid path

DESIGN & STRUCTURE

- All welded hybrid frame with added bolts
- Exclusive low profile outlet riser & open drum slot design for flat smooth hose wrap
- Permanently lubricated self-aligning pillow block bearing for trouble-free & smooth rotation & robust lubricated horizontal surface mount bearing for easy rotation
- Adjustable tension brake to prevent "free-wheeling" during operation
- Long-handled locking pin to secure reel from rotation during transport or storage

RETRACTION

- Reliable chain & sprocket drive on motor driven models
- Solid steel direct hand crank with smooth round handle
- All metal bevel crank and gear construction
- See Motor Options Chart

SIGNATURE FEATURES

- Professional grade heavy duty steel construction
- Durable proprietary CPC™ powder coat process
- Rolled edges & ribbed discs provide strength & safety
- Leading 2-year manufacturer's limited warranty
- Made in the U.S.A. - Sold & Supported Worldwide

POSSIBLE FIELDS OF APPLICATION

- High-flow Watering
- Fire Apparatus
- Chemical Fluid Transfer
- Mining Operations
- Construction Vehicles
- Water Trucks
- Bulk Liquid Handling
- OEM Systems

ACCESSORIZE YOUR REEL :: PG 56

- O-Rings & Swivels
- Roller Brackets & Crank
- Centrifugal Clutches
- 3 Way Brakes
- Speed Reducing Idler Sprockets
- 3 Way Pin Lock
- Rewind Actuators
- Crank Handle Holders
- Multi-angle Payouts
- Chain Guards

MOTOR OPTIONS

When ordering, suffix the model number with selection below. NOTE: Add 5 lbs to ship weight if reel is crated

SUFFIX	TYPE	DESCRIPTION	ADD ON APRX. LBS
A	AIR - 4 VANE	ALUMINUM BODY AIR MOTOR	8
AB	AIR - 6 VANE	CAST IRON AIR MOTOR	8
C	FRONT HAND CRANK	BEVEL GEARED CRANK	3
E	12 V DC, 1/3 HP	REVERSIBLE	13
ED	12 V DC, 1/2 HP EXP.	EXPLOSION PROOF, REVERSIBLE	26
EF	24 V DC, 1/3 HP	REVERSIBLE	13
EB	24 V DC, 1/2 HP EXP.	EXPLOSION PROOF, REVERSIBLE	26
EA	115 V AC, 1/2 HP EXP.	EXPLOSION PROOF REVERSIBLE AC RECTIFIED	26
EJ	230 V AC, 1/2 HP EXP.	EXPLOSION PROOF REVERSIBLE AC RECTIFIED	26
H	HYDRAULIC	END PORTED 9/16-18 UNF	6

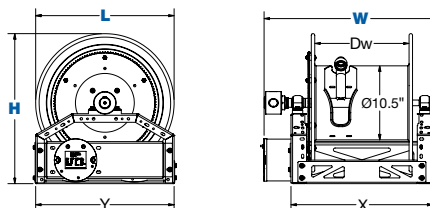

Go online to download the 1600 Brochure for more info at www.COXREELS.com



WARNING: Cancer and reproductive Harm – See page 22 of the MSDS

1/2" - 1" I.D.

1275 SERIES

LARGE CAPACITY DUAL HOSE REELS



COXREELS® 1275 Series "Dual Hose" hand crank or motorized hose reels are designed for large capacity applications. This series features dual plumbing with two swivel inlets and two low profile outlets that compliment the open drum slot and provide a non-crimping, flat smooth hose wrap. The industry preferred one piece all welded "A" frame design adds rigidity and strength while the positive gear drive rewind assures consistent trouble-free performance.

1275 SERIES - ALL REELS SUPPLIED LESS HOSE

MODEL	LESS HOSE										SIZE INDEX
	STANDARD CAP			OPTIONAL CAP. Reducer required			INLET SWIVEL & OUTLET RISER	PSI	APRX. LBS.		
	I.D.	O.D.	FT.	I.D.	O.D.	FT.					
1275-4-50-X	1/2"	7/8"	2/50	3/8"	3/4"	2/70	1/2" F NPT	3,000	40	1	
1275-4-100-X	1/2"	7/8"	2/100	3/8"	3/4"	2/140	1/2" F NPT	3,000	42	2	
1275-4-150-X	1/2"	7/8"	2/150	3/8"	3/4"	2/200	1/2" F NPT	3,000	47	3	
1275-4-200-X	1/2"	7/8"	2/200	3/8"	3/4"	2/300	1/2" F NPT	3,000	56	4	
1275-6-50-X	1"	17/16"	2/50	3/4"	1 1/4"	2/60	1" F NPT	3,000	63	5	
1275-6-75-X	1"	17/16"	2/75	3/4"	1 1/4"	2/110	1" F NPT	3,000	68	6	
1275-6-100-X	1"	17/16"	2/100	3/4"	1 1/4"	2/155	1" F NPT	3,000	74	7	
1275-6-150-X	1"	17/16"	2/150	3/4"	1 1/4"	2/200	1" F NPT	3,000	88	8	

1275 SERIES :: REEL SPECIFICATIONS

SWIVEL

- Two machined from solid brass 90° full-flow NPT swivel inlets (one on each side of the reel)
- Electroless nickel plated steel swivel on 1" models
- Swivel Seals: NITRILE

DESIGN & STRUCTURE

- All welded steel "A" frame construction for superior reel structure
- Two low profile outlet risers & open drum slot design for dual hose applications
- Permanently lubricated self-aligning pillow block bearings for trouble-free & smooth rotation

RETRACTION

- Reliable direct gear drive on motor driven models - **NO CHAIN**
- Bevel gear hand crank with removable handle for compact storage
- See Motor Options Chart

SIGNATURE FEATURES

- Professional grade heavy duty steel construction
- Durable proprietary CPC™ powder coat process
- Rolled edges & ribbed discs provide strength & safety
- Leading 2-year manufacturer's limited warranty
- Made in the U.S.A. - Sold & Supported Worldwide

POSSIBLE FIELDS OF APPLICATION

- Twin Agent Applications
- Fire Suppression
- Offshore Oil Rigs
- Shipyard & Port Operations
- Hydraulic
- Mining Operations
- Aircraft Maintenance
- Petroleum Production Fields

ACCESSORIZE YOUR REEL :: PG 56

- O-Rings & Swivels
- Roller Brackets
- Hoses
- Assorted Reel Accessories

- SUFFIX "X" OPTIONS

When ordering, substitute the "X" with selection below. NOTE: Add 5 lbs to ship weight if reel is crated.

SUFFIX	TYPE	DESCRIPTION	ADD ON APRX. LBS
A	AIR - 4 VANE	ALUMINUM BODY AIR MOTOR	8
C	FRONT HAND CRANK	BEVEL GEARED CRANK	3
E	12 V DC, 1/3 HP	REVERSIBLE	13
ED	12 V DC, 1/2 HP EXP.	EXPLOSION PROOF, REVERSIBLE	26
EF	24 V DC, 1/3 HP	REVERSIBLE	13
EB	24 V DC, 1/2 HP EXP.	EXPLOSION PROOF, REVERSIBLE	26
EA	115 V AC, 1/2 HP EXP.	EXPLOSION PROOF REVERSIBLE AC RECTIFIED	26
EJ	230 V AC, 1/2 HP EXP.	EXPLOSION PROOF REVERSIBLE AC RECTIFIED	26
H	HYDRAULIC	END PORTED 9/16-18 UNF	6

REEL DIMENSIONS

Technical Data Sheets Available On Website

SIZE INDEX	W			H		L	X	Y		Ø	Dw
	CRANK	ELEC.	AIR / HYD.	CRANK	ELEC.			CRANK	ELEC.		
1	18 7/8"	22 5/8"	19 7/8"	18 5/8"	19 1/8"	17 5/8"	13 3/8"	15 3/8"	16"	6 1/4"	8"
2	22 7/8"	26 5/8"	23 7/8"	18 5/8"	19 1/8"	17 5/8"	17 3/8"	15 3/8"	16"	6 1/4"	12"
3	28 7/8"	32 5/8"	29 7/8"	18 5/8"	19 1/8"	17 5/8"	23 3/8"	15 3/8"	16"	6 1/4"	18"
4	34 7/8"	38 5/8"	35 7/8"	18 5/8"	19 1/8"	17 5/8"	29 3/8"	15 3/8"	16"	6 1/4"	24"
5	29"	30 5/8"	27 3/4"	22 7/8"	22 7/8"	20"	19"	18 7/8"	18 7/8"	10 1/2"	13 1/2"
6	29"	30 5/8"	27 3/4"	26 1/8"	26 1/8"	24"	19"	20 3/8"	20 3/8"	10 1/2"	13 1/2"
7	35 5/8"	37"	34 1/4"	26 1/8"	26 1/8"	24"	25 1/2"	20 3/8"	20 3/8"	10 1/2"	20"
8	35 5/8"	37"	34 1/4"	30 1/16"	30 1/16"	28"	25 1/2"	22 9/16"	22 9/16"	10 1/2"	20"

Overall Dimensions

Base

Drum

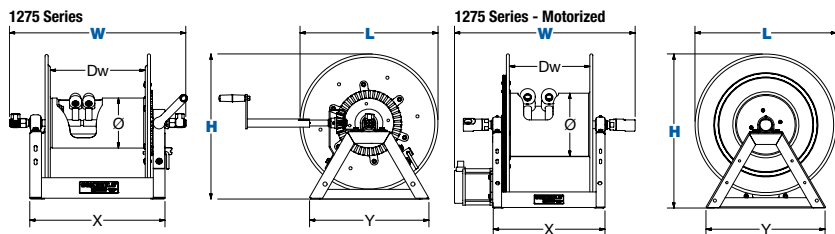

WARNING: Cancer and reproductive Harm – See page 22 of MSDS

COXREELS® 1125PCL Series professional-grade hand crank and motorized cord reels feature a drum-located, easy to access slip ring assembly for simple routine maintenance and a sturdy all-welded "A" frame built to efficiently handle the most demanding of tasks. The unique permanently lubricated and self-aligning pillow block bearings at each end of the drum allow smooth rotation and are specifically designed for rough, heavy-duty applications. These innovative models hold long lengths of 3 and 4 conductor 600V power cord (see chart for gage and capacity).

1125PC SERIES - ALL REELS SUPPLIED LESS CORD

MODEL	CORD GRIP RANGE (IN)	REEL STORAGE CAPACITY: CORD / O.D. (IN)						VOLTS	SLIP RING AMPS	SLIP RING # POLES	APPR. LBS.	SIZE INDEX
		12/3† (60 O.D.)	10/3† (66 O.D.)	8/3†† (70 O.D.)	12/4† (65 O.D.)	10/4† (72 O.D.)	8/4†† (78 O.D.)					
1125PCL-8312	.50-.63	250'	-	-	-	-	600	30	3	35	1	
1125PCL-8	.63-.75	-	200'	175'	-	-	600	30	3	35	1	
1125PCL-8M	.63-.75	-	200'	175'	-	-	600	45	3	35	1	
1125PCL-8410	.63-.75	-	-	-	225'	175'	600	30†††	4	35	1	
1125PCL-8410M	.63-.75	-	-	-	-	175'	600	40†††	4	35	1	
1125PCL-8408M	.75-.85	-	-	-	-	-	600	40†††	4	35	1	

† SOOW
 †† SEOOW
 ††† De-rate by 20% if energizing more than 3 poles

MOTOR OPTIONS When ordering, suffix the model number with selection below. NOTE: Add 5 lbs to ship weight if reel is crated

SUFFIX	TYPE	DESCRIPTION	ADD ON APPR. LBS
A	AIR - 4 VANE	ALUMINUM BODY AIR MOTOR	8
C	FRONT HAND CRANK	BEVEL GEARED CRANK	3
E	12 V DC, 1/3 HP	REVERSIBLE	13
ED	12 V DC, 1/2 HP EXP.	EXPLOSION PROOF, REVERSIBLE	26
EF	24 V DC, 1/3 HP	REVERSIBLE	13
EB	24 V DC, 1/2 HP EXP.	EXPLOSION PROOF, REVERSIBLE	26
EA	115 V AC, 1/2 HP EXP.	EXPLOSION PROOF REVERSIBLE AC RECTIFIED	26
H	HYDRAULIC	END PORTED 9/16-18 UNF	6

REEL DIMENSIONS Technical Data Sheets Available On Website

SIZE INDEX	W				H				L	X	Y		Ø	Dw
	CRANK	EXP. PROOF	12V DC MOTOR	AIR	HYD.	CRANK	MOTOR	CRANK			MOTOR			
1	21 7/8"	21 5/8"	19 7/8"	19 1/4"	18 7/8"	18 1/2"	19 3/16"	17 1/2"	13 3/8"	15 1/4"	16"	8 1/2"	8"	

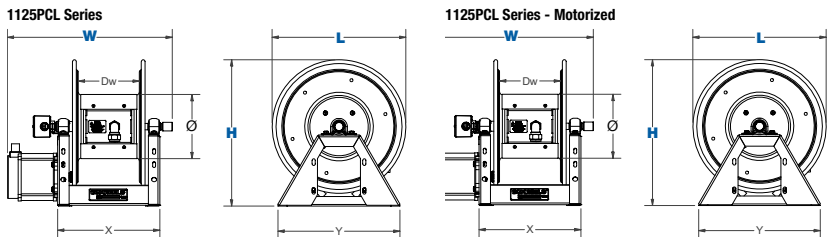

END USER CAUTION STATEMENTS

- Cord AWG, length, insulation rating, as well as single or multi-phase electrical service must be considered in determining the power rating for each reel. End use application must not exceed the lowest rated component (reel or cord). End user is responsible for determining and ensuring compliance to national and local codes as required.
- Disconnect power source from reel while unspooling / spooling cord.
- Cord should be completely unspooled from the reel when energized. Otherwise follow NEC ampacity derating factors in 310.15(B)(3)(a) where "# current carrying conductors in the service cord" X "#cord layers on the reel" = "# current carrying conductors" in a raceway. Apply the appropriate derating factor to the cord ampacity listed in 310.15(B)(16).

COXREELS® 1125PCL FEATURES

All Internal Components

- Drum-located slip ring assembly with easy access covers for simple routine maintenance.

External Connection Access

- User connections in externally mounted weatherproof outlet box (user to provide 3/4 trade size inlet fitting with integrated strain relief, or conduit connection)



1125PCL SERIES :: REEL SPECIFICATIONS

SLIP RING

- Drum-located slip ring assembly with easy to access cover for simple routine maintenance
- Available with 3-pole (30 Amp or 45 Amp) or 4-pole (30 Amp or 40 Amp) slip ring configurations - each rated at 600V (see chart).

DESIGN & STRUCTURE

- All welded steel "A" frame construction to strengthen the reel structure
- Narrow width for convenient installation in restricted spaces
- Permanently lubricated self-aligning pillow block bearings for trouble-free & smooth rotation
- 3/4" trade size single gang outlet box for external access to lead connections.
- "Cable Keeper" to prevent the lead cable from whipping or twisting
- Adjustable tension brake to prevent "free-wheeling" during operation
- Long-handled locking pin to secure reel from rotation during transport or storage

RETRACTION

- Reliable direct gear drive on motor driven models - **NO CHAIN**
- Solid steel direct hand crank with smooth round handle

SIGNATURE FEATURES

- Professional grade heavy duty steel construction
- Durable proprietary CPC™ powder coat process
- Rolled edges & ribbed discs provide strength & safety
- Leading 2-year manufacturer's limited warranty
- Made in the U.S.A. - Sold & Supported Worldwide

POSSIBLE FIELDS OF APPLICATION

- Power Tools
- Light Source
- General Industrial
- Manufacturing Plants & Facilities
- Service / Mechanic / Utility Vehicles
- Mining, Construction & Railroad Operations

ACCESSORIZE YOUR REEL :: Pg 56

- Roller Brackets
- Assorted Reel Accessories
- Stacking Brackets

WARNING: Cancer and reproductive Harm – See page 56

1/2" - 1" I.D.

100W & 1275W SERIES

LARGE CAPACITY WELDING REELS

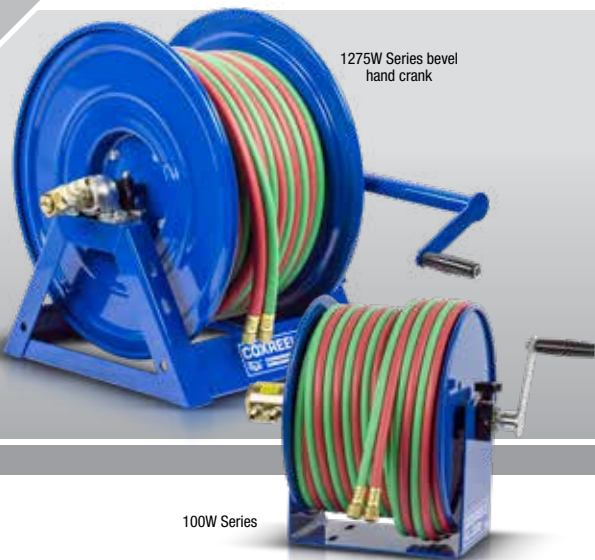

1275W Series bevel hand crank

100W Series

COXREELS® 100W Series “Welding” hand crank hose reels are lightweight, compact and versatile. Save time and effort while increasing the safety of your work environment. The sturdy “U” shaped frame and all steel construction make this one tough little reel.

100W SERIES

HOSE					LESS HOSE		SIZE INDEX
MODEL	I.D.	FT.	PSI	APRX. LBS.	MODEL	APRX. LBS.	
OXYGEN-ACETYLENE Oxy-Acetylene welding hose with 9/16" – 18 UNF welding hose fittings.							
112W-1-50	1/4"	50	200	28	112WL-1-50	18	1
112W-1-100	1/4"	100	200	37	112WL-1-100	18	2
117W-1-200	1/4"	200	200	68	117WL-1-200	30	3
OTHER FUELS T Grade welding hose with 9/16" – 18 UNF welding hose fittings.							
112WT-1-50	1/4"	50	200	28	112WTL-1-50	18	1
112WT-1-100	1/4"	100	200	37	112WTL-1-100	18	2
117WT-1-200	1/4"	200	200	68	117WTL-1-200	30	3

100W & 1275W SERIES :: REEL SPECIFICATIONS

100W SWIVEL

- External 90° full-flow dual ported brass swivel offering both connections from the same side of the reel
- Swivel seals: VITON®

100W DESIGN & STRUCTURE

- Compact solid one piece, heavy gauge steel “U” shaped frame with open drum design
- Composite bearing for smooth rotation
- Adjustable tension brake to prevent “free-wheeling” during operation, transport or storage

100W RETRACTION

- Direct hand crank rewind

1275W SWIVEL

- Two machined from solid brass 90° full-flow 3/8" NPT swivel inlets (One on each side of the reel)
- Swivel Seal: VITON®

1275W DESIGN & STRUCTURE

- All welded steel “A” frame construction for superior reel structure
- Exclusive low profile outlet risers & open drum slot design for flat smooth hose wrap
- Permanently lubricated self-aligning pillow block bearings for trouble-free & smooth rotation

1275W RETRACTION

- Choice of motor or bevel gear hand crank

SIGNATURE FEATURES

- Professional grade heavy duty steel construction
- Durable proprietary CPC™ powder coat process
- Rolled edges & ribbed discs provide strength & safety
- Leading 2-year manufacturer’s limited warranty
- Made in the U.S.A. - Sold & Supported Worldwide

POSSIBLE FIELDS OF APPLICATION

- Manufacturing Plants & Facilities
- Maintenance, Repair & Operations
- Welding / Service Trucks
- Welding Shops
- Automotive & Fleet Maintenance
- Garage Settings
- Pipelines
- Mining, Construction & Railroad Operations
- Marine/Ship Building/ Offshore

ACCESSORIZE YOUR REEL :: PG 56

- O-Rings & Swivels
- Roller Brackets
- Hoses
- Assorted Reel Accessories

WARNING: Cancer and reproductive Harm – See page 22

COXREELS® 1275W Series hand crank or motorized “Welding” hose reels are built to manage long lengths of bulky twin line welding hose. The direct bevel gear drive, low profile outlet riser and open drum slot design are features greatly appreciated by the regular user. Dual brass swivel inlets on each side of the reel assure full flow trouble free performance.

1275W SERIES

Oxy-Acetylene welding hose with 9/16" – 18 UNF welding hose fittings

HOSE					LESS HOSE		SIZE INDEX
MODEL	I.D.	FT.	PSI	APRX. LBS.	MODEL	APRX. LBS.	
OXYGEN-ACETYLENE Oxy-Acetylene welding hose with 9/16" – 18 UNF welding hose fittings.							
1275W-3-100-X	3/8"	100	200	73	1275WL-3-100-X	45	4
1275W-3-150-X	3/8"	150	200	90	1275WL-3-150-X	48	5
1275W-3-250-X	3/8"	250	200	126	1275WL-3-250-X	56	6
-	3/8"	350	200	-	1275WL-3-350-X	64	7
OTHER FUELS T Grade welding hose with 9/16" – 18 UNF welding hose fittings.							
1275WT-3-100-X	3/8"	100	200	73	-	-	4
1275WT-3-150-X	3/8"	150	200	90	-	-	5
1275WT-3-250-X	3/8"	250	200	126	-	-	6

- SUFFIX “X” OPTIONS

When ordering, substitute the “X” with selection below. NOTE: Add 5 lbs to ship weight if reel is crated.

SUFFIX	TYPE	DESCRIPTION	ADD ON APRX. LBS
A	AIR - 4 VANE	ALUMINUM BODY AIR MOTOR	8
C	FRONT HAND CRANK	BEVEL GEARED CRANK	3
H	HYDRAULIC	END PORTED 9/16-18 UNF	6

REEL DIMENSIONS

Technical Data Sheets Available On Website

SIZE INDEX	W		H		L	X	Y		Ø	Dw
	CRANK	ELEC.	CRANK	ELEC.			CRANK	ELEC.		
1	15 1/4"	-	13"	-	12"	6"	6"	-	5 1/2"	4 1/2"
2	18 3/4"	-	13"	-	12"	9 1/2"	6"	-	5 1/2"	8"
3	18 1/4"	-	18"	-	17"	9 1/2"	6"	-	5 1/2"	8"
4	18 7/8"	19 7/8"	18 5/8"	19 1/8"	17 5/8"	13 3/8"	15 3/8"	16"	6 1/4"	8"
5	22 7/8"	23 7/8"	18 5/8"	19 1/8"	17 5/8"	17 3/8"	15 3/8"	16"	6 1/4"	12"
6	28 7/8"	29 7/8"	18 5/8"	19 1/8"	17 5/8"	23 3/8"	15 3/8"	16"	6 1/4"	18"
7	34 7/8"	35 7/8"	18 5/8"	19 1/8"	17 5/8"	29 3/8"	15 3/8"	16"	6 1/4"	24"

Overall Dimensions

Base

Drum

100W Series

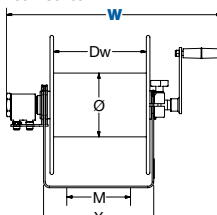

1275W Series

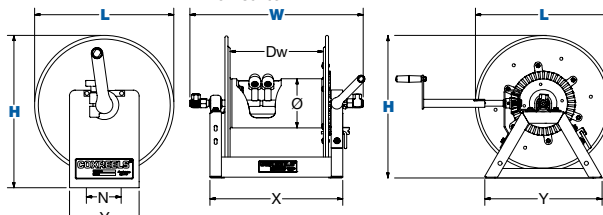

HAND CRANK

1/2" - 1" I.D.

SS 100, 1125 & 1175 SERIES STAINLESS STEEL HAND CRANK & MOTORIZED HOSE REELS



COXREELS® SS Series "Stainless Steel" hand crank hose reels have similar features to their related series, but are constructed of high quality electro-polished or unpolished as manufactured stainless steel with stainless steel fluid paths. They offer clean, non-corrosive performance in applications that require it, such as food and chemical processing, marinas, and anywhere that rust, corrosion and contamination thrive.

SS SERIES - ALL REELS SUPPLIED LESS HOSE

LESS HOSE							SIZE INDEX			
MODEL	I.D.	O.D.	FT.	PSI	APRX. LBS.					
SS100 SERIES - Hand Crank - SS100 Series is only available in SS finish.										
112-4-75-SS	1/2"	7/8"	75	4,000	21	1				
117-4-225-SS	1/2"	7/8"	225	4,000	31	2				
117-5-100-SS	3/4"	1 1/4"	100	4,000	36	3				
LESS HOSE							SIZE INDEX			
MODEL	STANDARD CAP			OPTIONAL CAP. Reducer required			INLET SWIVEL & OUTLET RISER	PSI	APRX. LBS.	SIZE INDEX
	I.D.	O.D.	FT.	I.D.	O.D.	FT.				
SS1125 SERIES - Hand Crank & Motor Driven										
1125-4-100-X	1/2"	7/8"	100	3/8"	3/4"	140	1/2" F NPT	3,000	36	4
1125-4-200-X	1/2"	7/8"	200	3/8"	3/4"	300	1/2" F NPT	3,000	39	5
1125-5-100-X	3/4"	1 1/4"	100	1/2"	7/8"	200	3/4" F NPT	3,000	42	6
1125-5-200-X	3/4"	1 1/4"	200	1/2"	7/8"	450	3/4" F NPT	3,000	55	7
SS1175 SERIES - Hand Crank & Motor Driven										
1175-6-100-X	1"	1 7/16"	100	3/4"	1 1/4"	150	1" F NPT	3,000	70	8
1175-6-200-X	1"	1 7/16"	200	3/4"	1 1/4"	300	1" F NPT	3,000	83	9

↳ Designate either SP or SS for choice of finish

SS SERIES - HAND CRANK/ MOTORIZED:: REEL SPECIFICATIONS

- SWIVEL**
- Non-corrosive machined from high quality stainless steel 90° full-flow NPT swivel inlet
 - Swivel Seals: NITRILE Non-Toxic Food Grade Grease

- DESIGN & STRUCTURE**
- Choice of stainless steel finish includes:
 - "SP" Standard unpolished "as manufactured" stainless steel finish
 - "SS" Electro-polished stainless steel finish
 - Each of these reels is built of their standard series with their own unique features & benefits

- RETRACTION**
- See page 40 for 100 Series features
 - See page 44 for 1125 Series features
 - See page 45 for 1175 Series features

- SIGNATURE FEATURES**
- Professional grade heavy duty steel construction
 - Rolled edges & ribbed discs provide strength & safety
 - Leading 2-year manufacturer's limited warranty
 - Made in the U.S.A. - Sold & Supported Worldwide

- POSSIBLE FIELDS OF APPLICATION**
- Corrosive Environments
 - Hygienic Environments
 - Fire Suppression
 - Medical Services
 - Marine/Docks/Offshore
 - Manufacturing Plants & Facilities
 - Pulp & Paper Plants
 - Food & Chemical Processing Plants
 - Bottling Plants
 - Dairies
 - Meat Packing
 - Grocery Stores
 - Restaurants & Commercial Kitchens
 - Water Treatment & Supply
 - Petrochemical
 - Food Grade Washdown

- ACCESSORIZE YOUR REEL :: PG 56**
- O-Rings & Swivels
 - Roller Brackets
 - Stacking Brackets
 - Hoses
 - Assorted Reel Accessories

MOTOR OPTIONS

When ordering, suffix the model number with selection below. NOTE: Add 5 lbs to ship weight if reel is crated

SUFFIX	TYPE	DESCRIPTION	ADD ON APRX. LBS
A	AIR - 4 VANE	ALUMINUM BODY AIR MOTOR	8
AB	AIR - 6 VANE	CAST IRON AIR MOTOR	8
C	FRONT HAND CRANK	BEVEL GEARED CRANK	3
E	12 V DC, 1/3 HP	REVERSIBLE	13
ED	12 V DC, 1/2 HP EXP.	EXPLOSION PROOF, REVERSIBLE	26
EF	24 V DC, 1/3 HP	REVERSIBLE	13
EB	24 V DC, 1/2 HP EXP.	EXPLOSION PROOF, REVERSIBLE	26
EA	115 V AC, 1/2 HP EXP.	EXPLOSION PROOF REVERSIBLE AC RECTIFIED	26
EJ	230 V AC, 1/2 HP EXP.	EXPLOSION PROOF REVERSIBLE AC RECTIFIED	26
H	HYDRAULIC	END PORTED 9/16-18 UNF	6

REEL DIMENSIONS

Technical Data Sheets Available On Website

SIZE INDEX	W			H			L	X	Y		Ø	Dw	
	CRANK	ELEC.	AIR / HYD.	CRANK	ELEC.	L			X	CRANK			ELEC.
										CRANK			ELEC.
1	22 3/4"	-	-	13"	-	12"	14"	6"	-	5 1/2"	12 1/2"		
2	22 3/4"	-	-	18"	-	17"	14"	6"	-	5 1/2"	12 1/2"		
3	23 1/4"	-	-	18"	-	17"	14"	6"	-	5 1/2"	12 1/2"		
4	19 1/2"	19 3/4"	17"	18 3/4"	19 1/4"	17 5/8"	11 3/8"	15 3/8"	16"	6 1/4"	6"		
5	25 1/2"	25 3/4"	23"	18 3/4"	19 1/4"	17 5/8"	17 3/8"	15 3/8"	16"	6 1/4"	12"		
6	26 3/4"	26"	23 3/8"	18 3/4"	19 1/4"	17 5/8"	17 3/8"	15 3/8"	16"	6 1/4"	12"		
7	38 3/4"	38"	35 3/8"	18 3/4"	19 1/4"	17 5/8"	29 3/8"	15 3/8"	16"	6 1/4"	24"		
8	28 1/8"	26"	24 1/2"	26 1/8"	26 1/8"	24"	17"	20 1/8"	20 1/8"	10 1/2"	11 1/2"		
9	36 5/8"	34 1/2"	33"	26 1/8"	26 1/8"	24"	25 1/2"	20 1/8"	20 1/8"	10 1/2"	20"		

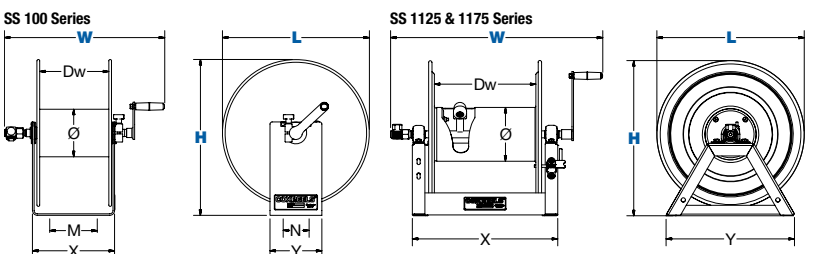

WARNING: Cancer and reproductive Harm - See page 22

HAND CRANK MOTORIZED

COXREELS® Storage hand crank and motorized reels have the features demanded by industry professionals. These features include a CNC robotically heavy duty spun and ribbed discs with rolled edges for added strength, safety and durability and a sturdy all-welded "A" frame built to efficiently handle the most demanding storage tasks on either stationary or mobile units. These innovative models were selected from Coxreels standard series to handle long length of various materials including but not limited to hose, collapsible hose, power cord, cable, rope, wire, barbed wire, tape, and chain.

STORAGE MODELS

- NOT ALL STORAGE REELS ARE LISTED, PLEASE CONSULT FACTORY FOR MORE MODELS.

MODEL		LESS HOSE/CORD/CABLE							
		1125 SERIES				1175 SERIES		1185 SERIES	
		1125-4-200-BYXX	1125-4-325-BYXX	1125-5-200-BYXX	1125-5-250-BYXX	1175-6-100-BYXX	1175-6-200-BYXX	1185-2028-BYXX	1185-3328-BYXX
HOSE, ROPE, CABLE O.D.	1/4"	3,250'	4,875'	6,500'	7,600'	5,600'	9,750'	14,110'	23,250'
	3/8"	1,475'	2,225'	2,975'	3,450'	2,435'	4,305'	6,100'	10,135'
	1/2"	810'	1,215'	1,625'	1,900'	1,330'	2,310'	3,375'	5,575'
	5/8"	525'	775'	1,060'	1,225'	785'	1,400'	2,255'	3,665'
	3/4"	335'	500'	675'	775'	605'	1,055'	1,400'	2,375'
	1"	210'	265'	350'	410'	285'	515'	770'	1,275'
	1 1/4"	100'	165'	225'	260'	195'	350'	560'	915'
	1 1/2"	65'	100'	135'	150'	120'	220'	305'	515'
	1 3/4"	50'	90'	115'	140'	70'	135'	275'	450'
	2"	30'	50'	60'	75'	65'	125'	190'	310'
	2 1/4"	25'	45'	55'	65'	65'	105'	110'	190'
	2 1/2"	20'	40'	50'	60'	30'	60'	110'	180'
	2 3/4"	15'	35'	45'	55'	30'	55'	100'	175'
3"	10'	15'	20'	20'	25'	50'	50'	95'	
LAY FLAT HOSE	1"	200'	290'	380'	475'	350'	640'	930'	1,520'
	1 1/2"	140'	210'	285'	330'	120'	245'	325'	595'
	2"	95'	140'	190'	220'	90'	205'	270'	490'
	2 1/2"	70'	105'	140'	165'	80'	185'	270'	430'
	3"	55'	85'	110'	130'	70'	160'	240'	280'
APRX. LBS.		39	48	55	59	70	83	109	169
SIZE INDEX		1	2	3	4	5	6	7	8

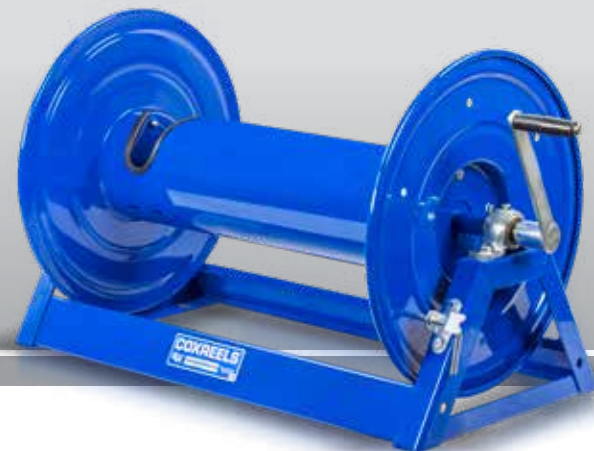

STORAGE SERIES :: REEL SPECIFICATIONS

DESIGN

- Hand crank & motor driven reels to store & maintain long length of hose, cord, cable, wire, rope, tape, chain & other
- Reels have no swivel & no riser, for storage only (Model with suffix -BYXX)
- Sturdy "A" frame base design

STRUCTURE

- All welded steel "A" frame construction to strengthen the reel structure
- Each of these reels is built on the strength of their standard series with their own unique features & benefits

RETRACTION

- See page 44 For 1125 Series features
- See page 45 For 1175 Series features
- See page 46 For 1185 Series features

SIGNATURE FEATURES

- Professional grade heavy duty steel construction
- Durable proprietary CPC™ powder coat process
- Rolled edges & ribbed discs provide strength & safety
- Leading 2-year manufacturer's limited warranty
- Made in the U.S.A. - Sold & Supported Worldwide

POSSIBLE FIELDS OF APPLICATION

- Hose
- Collapsible Hose
- Power Cord
- Cable
- Rope
- Wire
- Barbed Wire
- Tape
- Chain
- ...and much more

ACCESSORIZE YOUR REEL :: PG 56

- O-Rings & Swivels
- Stacking Brackets
- Roller Brackets
- Hoses
- Assorted Reel Accessories

MOTOR OPTIONS

When ordering, suffix the model number with selection below. NOTE: Add 5 lbs to ship weight if reel is crated

SUFFIX	TYPE	DESCRIPTION	ADD ON APRX. LBS
A	AIR - 4 VANE	ALUMINUM BODY AIR MOTOR	8
AB	AIR - 6 VANE	CAST IRON AIR MOTOR	8
C	FRONT HAND CRANK	BEVEL GEARED CRANK	3
E	12 V DC, 1/3 HP	REVERSIBLE	13
ED	12 V DC, 1/2 HP EXP.	EXPLOSION PROOF, REVERSIBLE	26
EF	24 V DC, 1/3 HP	REVERSIBLE	13
EB	24 V DC, 1/2 HP EXP.	EXPLOSION PROOF, REVERSIBLE	26
EA	115 V AC, 1/2 HP EXP.	EXPLOSION PROOF REVERSIBLE AC RECTIFIED	26
EJ	230 V AC, 1/2 HP EXP.	EXPLOSION PROOF REVERSIBLE AC RECTIFIED	26
H	HYDRAULIC	END PORTED 9/16-18 UNF	6

REEL DIMENSIONS

Technical Data Sheets Available On Website

SIZE INDEX	W		H		L	X	Y		Ø	Dw	
	CRANK	ELEC.	CRANK	ELEC.			CRANK	ELEC.			
1	23 7/8"	25 3/4"	23"	18 3/4"	19 1/4"	17 5/8"	17 3/8"	15 3/8"	16"	6 1/4"	12"
2	29 7/8"	31 3/4"	29"	18 3/4"	19 1/4"	17 5/8"	23 3/8"	15 3/8"	16"	6 1/4"	18"
3	37 1/8"	38"	35 3/8"	18 3/4"	19 1/4"	17 5/8"	29 3/8"	15 3/8"	16"	6 1/4"	24"
4	41 1/8"	42"	39 3/8"	18 3/4"	19 1/4"	17 5/8"	33 3/8"	15 3/8"	16"	6 1/4"	28"
5	24 3/8"	26"	24 1/2"	26 1/8"	26 1/8"	24"	17"	20 1/8"	20 1/8"	10 1/2"	11 1/2"
6	32 7/8"	34 1/2"	33"	26 1/8"	26 1/8"	24"	25 1/2"	20 1/8"	20 1/8"	10 1/2"	20"
7	32 3/8"	34 5/8"	31 7/8"	30"	30"	28"	25 1/2"	24 1/2"	24 1/2"	10 1/2"	20"
8	45 3/8"	47 5/8"	44 7/8"	30"	30"	28"	38 1/2"	24 1/2"	24 1/2"	10 1/2"	33"

Overall Dimensions

Base

Drum

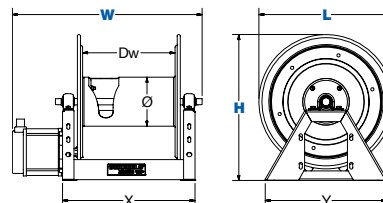

WARNING: Cancer and reproductive Harm – See page 665

ACCESSORIES *SPRING DRIVEN, HAND CRANK & MOTORIZED REELS*

SWIVELS & O-RING COMPATIBILITY CHART

	Brass	Zinc Plated Steel	Electroless Nickel Plated Steel	Stainless Steel	In-Line Nickel Plated Steel or Stainless Steel	Melonized Steel
Available Swivel I.D. Female NPT fittings (*BSP fittings available)	1/4"	•	•		•	•
	3/8"	•	•		•	
	1/2"	•	•		•	
	3/4"	•			•	
	1"			•	•	
	1 1/2"			•	•	•
	2"			•	•	•
Available Swivel Seals (Refer to O-Ring Compatibility Chart for desired application)	Buna	•	•	•	•	
	EPDM	•	•	•	•	
	Viton®	•	•	•	•	•
	AFLAS			•	•	

O-RING COMPATIBILITY CHART

Intended as a general guideline only. Users must test under their own operating guidelines to determine suitability. Please consult factory if your application is not listed.

1 = Recommended | 2 = Fair | 3 = Poor | 4 = Unsatisfactory

	ACETYLENE	AIR (-30°F TO +25°F)	AIR (+25°F TO 200°F)	AIR (200°F TO 300°F)	AIR (300°F TO 400°F)	ANTIFREEZE	FUEL OIL / KEROSENE	GREASE (PETROLEUM BASED)	HYDROCHLORIC ACID	MOTOR OIL (PETROLEUM BASED)	NATURAL GAS	NITROGEN	OXYGEN (200°F TO 300°F)	OXYGEN (COLD)	PESTICIDES	STEAM (BELOW 300°F)	STEAM (300°F TO 400°F)	SEA WATER	WATER (UP TO 200°F)
→	1	1	1	3	4	2	1	1	3	1	1	1	4	2	2	4	4	1	1
→	1	1	1	2	4	1	4	4	2	4	4	1	4	2	4	1	2	1	1
→	1	2	1	1	1	2	1	1	1	1	1	2	1	1	2	3	2	2	2
→	1	3	1	1	1	1	2	2	1	2	1	4	2	1	2	3	1	1	



Brass Swivels

CNC machined from solid brass swivels are built for general multi-purpose applications. Configured in a 90 degree fluid path with full flow designed. Working pressure up to 3,000 PSI & -40°F to 400°F*.



Zinc Plated Steel Swivels

Machined from strong low carbon steel & configured in a 90 degree fluid path with full flow designed. Zinc plated steel swivels are recommended for non-corrosive applications. Working pressure up to 5,000 PSI & -40°F to 400°F*.



Electroless Nickel Plated Steel Swivels

Machined from strong low carbon steel & configured in a 90 degree fluid path with full flow designed. Nickel plated steel swivels are recommended for mildly corrosive applications. Working pressure up to 4,000 PSI & -40°F to 400°F*.



Stainless Steel Swivels

Machined from high quality, pure 316 stainless steel & configured in a 90 degree fluid path with full flow designed. Stainless steel swivels offer superior corrosion protection. Working pressure up to 5,000 PSI & -40°F to 400°F*.



In-line Swivels

Nickel plated steel or stainless steel swivel configured in an in-line fluid path with full flow design. Working pressure up to 1,500 PSI for 1 1/2" I.D. & 1,000 PSI for 2" I.D. -40°F to 400°F*.



Melonized Steel Swivels

Configured in a 90 degree fluid path with 1/4" ports, melonized steel swivels are used for hydraulic applications. Working pressure up to 10,000 PSI & -5°F to 400°F*.

*Temperature rating depends on the seal type selected

HOSE UPGRADES

NITRILE Hose

Premium high quality, oil resistant, multi-purpose hose that is excellent for air and water service and many other chemical applications. The high tensile spiral synthetic yarn reinforcement provides excellent kink resistance. This industrial grade hose exceeds RMA Class A-High Oil Resistance requirements. Electrically non-conductive with a minimum resistance of one megaohm per inch at 1000 volts DC. Temperature Range: -20°F to +212°F.

SUFFIX	TUBE MATERIAL	COVER	REINFORCEMENT BRAIDS	I.D.	O.D.	PSI	WEIGHT (LBS/FT.)
OG	Black Nitrile	Reinforced Nitrile	Spiral Synthetic Yarn	1/4"	1/2"	300	0.12
OG	Black Nitrile	Reinforced Nitrile	Spiral Synthetic Yarn	3/8"	1 1/16"	300	0.17
OG	Black Nitrile	Reinforced Nitrile	Spiral Synthetic Yarn	1/2"	27/32"	300	0.26
OG	Black Nitrile	Reinforced Nitrile	Spiral Synthetic Yarn	3/4"	15/32"	300	0.39

SYNTHETIC RUBBER-EPDM Hose

Versatile general purpose hose that is excellent for air and water service and many agricultural chemical transfer applications. The synthetic rubber tube and cover resists heat, sunlight, ozone and weathering. The high tensile spiral synthetic yarn reinforcement provides excellent kink resistance. This industrial grade hose exceeds RMA class C medium oil resistance requirements. Temperature Range: -40°F to +212°F. ***NOT SUITABLE FOR THE TRANSFER OF PETROLEUM PRODUCTS.**

SUFFIX	TUBE MATERIAL	COVER	REINFORCEMENT BRAIDS	I.D.	O.D.	PSI	WEIGHT (LBS/FT.)
RH	Black Synthetic Rubber	Red Synthetic Rubber	Spiral Synthetic Yarn	1/4"	1/2"	300	0.12
RH	Black Synthetic Rubber	Red Synthetic Rubber	Spiral Synthetic Yarn	3/8"	1 1/16"	300	0.17
RH	Black Synthetic Rubber	Red Synthetic Rubber	Spiral Synthetic Yarn	1/2"	27/32"	300	0.25
RH	Black Synthetic Rubber	Red Synthetic Rubber	Spiral Synthetic Yarn	3/4"	15/32"	300	0.37

HI-VIS Hose

Hi-Vis hose is hybrid (PVC + Rubber blend) bright yellow hose with a white glossy stripe that offers similar performance to rubber with the weight of PVC. It has increased hose flexibility and better low temperature behavior while maintaining strength and toughness. With enhanced kink resistance and reduced coil memory, it lays flat for a reduced trip hazard potential. This hose is perfect to be used in applications involving air and water. Temperature range: -40°F to 158°F. PSI: 300 at 70°F

SUFFIX	TUBE MATERIAL	COVER	REINFORCEMENT BRAIDS	I.D.	O.D.	PSI	WEIGHT (LBS/FT.)
HV	Yellow flexible TPE, ARPM Class B tube	High Visibility yellow flexible TPE with white stripe cover	Spiral Polyester Yarn	3/8"	5/8"	300	0.10
HV	Yellow flexible TPE, ARPM Class B tube	High Visibility yellow flexible TPE with white stripe cover	Spiral Polyester Yarn	1/2"	3/4"	300	0.10

ADAPTORS & REDUCERS



Adaptors are used where the size of the connection device is larger than, or of an equivalent size, to the entry thread of the enclosure.

Reducers are used where the thread size of the entry device is smaller than the entry thread of the enclosure

REDUCERS

PART NO.	END FITTING	DESCRIPTION	PSI
10780	NPT	3/8" NPT-Female x 1/4" NPT-Male	300 MAX
7541	NPT	1/2" NPT-Male x 1/4" NPT-Female	150 MAX
7545	NPT	1/2" NPT-Male x 3/8" NPT-Female	200 MAX
7845	NPT	1" NPT-Female x 1/2" NPT-Female	3,000 MAX
7845-1	NPT	1" NPT-Male x 3/4" NPT-Female	3,000 MAX
1578	NPT	1 1/2" NPT-Male x 1 1/4" NPT-Female	300 MAX

ADAPTORS

PART NO.	END FITTING	DESCRIPTION	PSI
10781	GHT	1/2" NPT - Female x 3/4" Garden - Male	250 MAX
10782	GHT	1/2" NPT - Male x 3/4" Garden - Male	250 MAX
10783	GHT	3/4" NPT - Male x 3/4" Garden - Male	250 MAX
10784	NPT	1" NPT - Male x 1" NPT-Male	4,000 MAX
7540	NPT	1/2" NPT - Male x 3/8" NPT - Female	6,000 MAX
7540-1	NPT	1/2" NPT - Male x 1/4" NPT - Female	6,000 MAX
7765-1	NST	1" NPT - Male x 1" NST - Male	300 MAX
7765-2	NST	1 1/2" NPT - Male x 1 1/2" NST - Male	300 MAX
7817	JIC	1/2" NPT - Male x 7/16-20 (-5) JIC	4,000 MAX
7818	JIC	3/8" NPT - Male x 1/2-20 (-4) JIC	4,000 MAX
7821	BSP	1/2" -14 NPT - Male x 1/4" -19 BSP - Female	4,500 MAX
7848	NPT	1/2" -14 NPT - Male x M14 Female	6,000 MAX
8165	Victaulic	2" NPT - Male x Victaulic	1,000 MAX

WARNING: Cancer and reproductive Harm – See page

GOODYEAR
RUBBER PRODUCTS, INC.



727-342-5088

You can also email us at
GRP@goodyearrubberproducts.com

MOUNTING & ROLLER BRACKETS

PART NO.	REEL SERIES									
	P	SH, MP & HP	T	C	EN	PC	P-W & SHW	P-WC	Alumi-Pro®	Nitro-Pro®
 <p>Swing Bracket For vertical surface mounting (only stationary installations), allows reel to swing 180°. Powder coated crinkle black 1/4" steel. Weight: 5 lbs.</p>	15720	•	•			•	•	•	•	•
	15725			•	•					
 <p>Swivel Bracket For horizontal surface mounting (only stationary installations), ball bearing rotation, allows reel to swivel 345°. Powder coated crinkle black heavy gauge steel. Weight: 6 lbs. NOT FOR USE IN CEILING APPLICATIONS.</p>	15721	•	•	•	•	•	•	•	•	•
 <p>EZ-Up Bracket Reel easily slides in & out for easy overhead mounting. Use as an alternative to the #MR-1. Must be ordered with #15724 for "I" or "H" beam installations. Weight: 6.5 lbs.</p>	15723	•	•			•	•	•	•	•
 <p>EZ-Up "I" or "H" Beam Adapter Must be ordered with #15723. Powder coated crinkle black, all steel construction. Weight: 5 lbs.</p>	15724	•	•			•	•	•	•	•
 <p>Mounting Bracket For overhead mounting, fits 3" to 8 1/2" flange on "I" or "H" beam. Powder coated crinkle black 3/16" bent steel. Weight: 13 lbs.</p>	MR-1	•	•			•	•	•	•	•
	MRT-1			•	•					
 <p>4-Way Roller Bracket Heavy gauge steel, powder coated Coxreels blue (4RB) Available in stainless steel (4RB-SS). Available with solid detring rollers (4SR & 4SR-SS) Weight: 1 lbs.</p>	4RB 1/4"-3/4"	•	•	•	•	•	•	•	•	•
	4RB-SS 1/4"-3/4"	•	•	•	•	•	•	•	•	•
	4SR 1/4"-3/4"	•	•	•	•	•	•	•	•	•
	4SR-SS 1/4"-3/4"	•	•	•	•	•	•	•	•	•
 <p>4-Way Roller Bracket Heavy gauge steel, powder coated Coxreels blue with stainless steel rollers (4SRB) Available in stainless steel (4SRB-SS) Weight: 1 lbs.</p>	4SRB-4 1/2"	•	•	•	•				•	
	4SRB-5 3/4"	•	•							
	4SRB-6 1"	•								

S SERIES MOUNTING & ROLLER BRACKETS

PART NO.	S SERIES MODELS			
	SR13 & SL13	SR15 & SL15	SR17 & SL17	SR19 & SL19
 <p>Dual Side Mount Bracket Heavy gauge steel, powder coated crinkle black. Weight: 5 lbs.</p>	15726-13	•		
	15726-15		•	
	15726-17			•
	15726-19			
 <p>Single Side Mount Bracket Heavy gauge steel, powder coated crinkle black Weight: 2 lbs.</p>	SMB1	•	•	
	SMB2			•
	SMB3			

INLET HOSE ASSEMBLIES

PART NO.	FITTINGS	I.D.	LENGTH	PSI
5150-1.5	1/4" Male x Female NPT	1/4"	18"	300
5153-1.5	3/8" Male x Female NPT	3/8"	18"	300
5154-1.5	1/2" Male x Female NPT	1/2"	18"	300
5155-1.5	3/4" Male x Male NPT	3/4"	18"	300
5224-1.5	3/8" Male x Male NPT	3/8"	18"	3,000
5256-1.5	1/2" Male x Male NPT	1/2"	18"	2,500
5290-1.5	3/4" Male x Male NPT	3/4"	18"	1,500
5304-1.5	1/4" Male x Male NPT	1/4"	18"	5,000
5336-1.5	3/8" Male x Male NPT	3/8"	18"	4,000
15717	Garden 3/4"(w/Part #10781) x 3/4" NPT w/adaptor #10782	1/2"	48"	300
5423-1.5	Twin Grade R 1/8" NPTM x BB 9-16 UNF	1/4" Twin	18"	200
5424-1.5	"T" Grade Twin Grade R 1/8" NPTM x BB 9-16 UNF	1/4" Twin	18"	200

90° ELBOWS

PART NO.	FITTING THREAD	I.D.	PSI
6088	Brass LP Male x Female NPT	1/4"	300
208	Brass LP Male x Female NPT	3/8"	300
222	Brass LP Male x Female NPT	1/2"	300
385	Brass LP Male x Female NPT	3/4"	300
500	Steel MP Male x Female NPT	3/8"	3,000
1671	Steel MP Male x Female NPT	1/2"	3,000
15014	Steel MP Male x Female NPT	3/4"	1,250
616	Steel HP Male x Female NPT	1/4"	5,000
617	Steel HP Male x Female NPT	3/8"	5,000

HOSE STOPS & GUARDS

HOSE STOPS PART NO.	HOSE GUARD PART NO.	HOSE		CORD	OVERALL
		I.D.	O.D.		
131	237-1	1/4"	1/2"	12/3 SJO	2 1/2"
131-1	237-1	-	-	16/3 SJO	2 1/2"
633	237-1	1/4" Twin Line		-	3 1/2"
131-3	237-1	3/8"	2 1/32"	10/3 SO	2 1/2"
131-4	398-1	1/2"	3/4"	-	2 1/2"
254	-	1/2"	3/4"	-	3 1/2"
430	398-1	3/4"	1"	-	3 1/2"
20214	-	1"	1 9/16"	-	5"
20215	-	1 1/4"	1 3/16"	-	5"
20216	-	1 1/2"	2 1/16"	-	5"
20217	-	2"	2 9/16"	-	5"

BEND RESTRICTORS

ADD SUFFIX	I.D.	DESCRIPTION	PSI
-BxB	1/4"	Black PVC Bend Restrictor	300
-BxB	3/8"	Black PVC Bend Restrictor	300
-BxB	1/2"	Black PVC Bend Restrictor	300

Designed to limit the degree of bending without compromising the integrity of the hose assembly while also preventing the hose-end from kinking, excessive wearing, & tearing.

QUICK DISCONNECTS

PART NO.	I.D.	DESCRIPTION	CONNECTION	PSI
10759-1	1/4"	Quick Disconnect	NPT (F)	300
10759-2	3/8"	Quick Disconnect	NPT (F)	300

Quick disconnect couplings thread onto end of hose fitting to provide fast, leak-proof connections for low pressure hose lines. Conveniently connect, interchange, & secure pneumatic tools or other spraying devices to any air, water, chemical or other hose lines.

SPRING DRIVEN



WARNING: Cancer and reproductive Harm – See page 88-90

ACCESSORIES *HAND CRANK & MOTORIZED REELS*

ROLLER BRACKETS

4-WAY ROLLER BRACKETS



Top Rewind
4-way enclosed pinch-proof stainless steel rollers are 1" in diameter supported by powder coated steel brackets. Specify drum width. Weight: 10 lbs.



Top Rewind CEILING MOUNT APPLICATIONS
4-way enclosed pinch-proof stainless steel rollers are 1" in diameter supported by powder coated steel brackets. Specify ceiling mount & specify drum width. Weight: 10 lbs.



Bottom Rewind
4-way enclosed pinch-proof stainless steel rollers are 1" in diameter supported by powder coated steel brackets. Specify drum width. Weight: 10 lbs.



Top Rewind Extension
4-way enclosed pinch-proof stainless steel rollers are 1" in diameter supported by powder coated steel brackets. Specify drum width. Weight: 10 lbs.



4-Way Roller
4-way enclosed pinch-proof stainless steel rollers are 1" in diameter.



Universal Roller 4-Way
4-way enclosed pinch-proof stainless steel rollers are 1" in diameter. Mounted on universal bracket with 4 various positions 0°, 30°, 60°, 90°. Made from steel, powder coat black.

† This bracket only works with idler gears on 28" models. Consult factory.

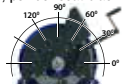

*Add drum width dimension as the suffix to the part number

EXAMPLE: An 1125-4-200 reel drum width is 12". Order part number: 15353-12

1125 SERIES STACKING BRACKET



Top Rewind
Stack your 1125 Series reels for double the storage in the same work area. Powder coated crinkle black, steel construction. Weight 6 lbs.

*Add drum width dimension as the suffix to the part number

EXAMPLE: An 1125-4-200 reel drum width is 12". Order part number: 7480-12

WARNING: Cancer and reproductive Harm – See page 28

PART NO.	AVAILABLE FOR SERIES						
	100	1125	1175	1185	1195	1275	1600
9075-8 8" disc size	•						
9075-12.5 12" disc size	•						
9073-8 17" disc size	•						
9073-12.5 17" disc size	•						
9073-18 17" disc size	•						
15353*	•						•
15355* 1275W-C						•	
15357*		•					
15368* 28" disc size					•		
15368-1* 32" disc size					•		
15369* 24" disc size			•				
15369-1* 28" disc size			•				
16901 20" disc size							•
16902 24" disc size							•
16903 28" disc size							•
15358*		•					•
15356*			•				
15354*		•					•
15037*			•				
15370-1*				•			
15370*					•		
PART OF FRAME							•
15353-P*		•					
CONSULT FACTORY		•	•	•	•	•	•
16930 20" disc size							•
16931 24" disc size							•
16932† 28" disc size							•

3-WAY ROLLER BRACKET ASSEMBLIES



Top Rewind
3-way open spool roller assembly with 1.5" chrome-plated machined steel spools & 1.5" stainless steel tubing bottom roller & powder coated steel brackets. Specify drum width. Weight: 14 lbs.



Bottom Rewind
3-way open spool roller assembly with 1.5" chrome-plated machined steel spools & 1.5" stainless steel tubing bottom roller & powder coated steel brackets. Specify drum width. Weight: 14 lbs.



3-Way Roller
3-way open spool roller assembly with 1.5" chrome-plated machined steel spools & 1.5" stainless steel tubing bottom roller.



Universal Roller 3-Way
3-way open spool roller assembly with 1.5" chrome-plated machined steel spools and 1.5" stainless steel bottom roller. Mounted on universal bracket with 4 various positions 0°, 30°, 60°, 90°. Made from steel, powder coat black. Mount multiple roller guides for dual direction payout.

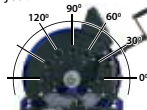

† This bracket only works with idler gears on 28" models. Consult factory.

*Add drum width dimension as the suffix to the part number

EXAMPLE: An 1125-4-200 reel drum width is 12". Order part number: 15359-12

PART NO.	AVAILABLE FOR SERIES				
	1125	1175	1185	1275	1600
15359*	•				•
15360* 24" disc size		•	•		
15361* 28" disc size			•		
15362*	•				•
15363* 24" disc size		•	•		
15364* 28" disc size			•		
CONSULT FACTORY	•	•	•	•	•
16933 20" disc size					•
16934 24" disc size					•
16935† 28" disc size					•

HOSE GUIDES



Pivoting Hose Guide
Heavy gauge powder coated steel arm & pivot mount w/5 locking positions. Stainless steel enclosed 4-way roller system & zinc plated axle for non-corrosive performance. Specify drum width. (For motor options E & ED only). Weight: 17 lbs.



Pivoting Hose Guide HD
Heavy gauge powder coated steel arm & pivot mount w/5 locking positions. Large 1" diameter pivot shaft. Sealed precision bearings support pivot shaft & chrome-plated billet aluminum guide rollers. Specify drum width. (For motor options E & ED only). Weight: 17 lbs.



Sliding Hose Guide
4-way, solid black delrin roller assembly, smooth tapered handle, non-corrosive zinc plated solid rods, heavy gauge "CPC" powder coated steel framing. Specify drum width. Weight: 8 lbs.

PART NO.	AVAILABLE FOR SERIES		
	1125	1175	1185
15733 Top Return	•		
15732 Bottom Return	•		
15728 Bottom Return		•	•
15729 Top Return		•	
15730 Top Return			•
15734	•		



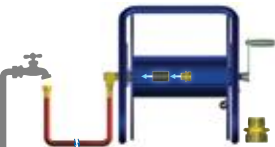



GARDEN HOSE KIT



Garden Hose Kit
You are able to connect any hose to a reel with 1/2" plumbing. You will be able to use any garden hose for everything from watering plants to washing your car. Kit includes: NPT to garden hose adaptor & adaptor hose.

PART NO.	AVAILABLE ON
	1/2" Plumbing On Any Reel
15717	•

MODEL UPGRADES & ADDITIONS



	PART NO.	AVAILABLE FOR SERIES							
		100	V100	1125	1175	1185	1195	1275	1600
 <p>Spring Loaded Lock Pin The spring-loaded lock pin assembly is designed to lock & secure the reel, even in mobile conditions over rough terrain.</p>	9077	•	•						
	20843			•	•	•	•	•	•
 <p>3-Way Pin Lock Kit 3 Positions - Pin locks reel with heavy duty 3/4" solid steel pin. Disengages for free unwind. Can be used to activate switch for electric rewind.</p>	16702								•
	16400								•
 <p>Universal Bracket Kit 4 various positions 0°, 30°, 60°, 90° for mounting bevel crank on either side of the reel. Includes removable center guard cap for easy bearing access. Made from powder coated steel.</p>	7406			•					
	7700 24" disc size				•				
	8176						•		
	8176-1 24" disc size						•		
	8176-2 28" disc size						•		
	16601-122 20" disc size								•
	16602-138 24" disc size								•
	16602-180 28" disc size								•
 <p>Gear Guards Guards beveled gears or chain & sprocket from dirt & foreign matter, while also protecting operator from injury.</p>	17250-2 (1:2 ratio)						•	•	
	17250-3 (1:3 ratio)						•	•	
	17250-4 (1:4 ratio)						•	•	
	Prefix model BX	•	•						
 <p>Brawny Reel Upgrade Available for 1125 Series for 3,000 PSI (BX) or 5,000 PSI (BH) - 10 gauge plates welded into each disc to keep them from bowing. - Prevents deformation & eventual crushing of the drum that can be caused by hose pressure. - The center drum has been thickened from 16GA to 14GA.</p>	Prefix model BH			•					
	7429-1-4			•					
 <p>High Temperature Drag Brake For 1/2" models</p>	7429-1-5			•					
	 <p>High Temperature Drag Brake For 3/4" models</p>	16703							•
 <p>Heavy Duty Band Brake Steel band lined with brake friction material. Tension is adjusted with a wing nut or a knob by hand (no tools required). - Increased braking power - Increased brake life. - Easier & more precise brake adjustment (control).</p>		8340			•	•			
	8302					•			
	8302-1 90° Swivel					•			
	16705								•

MODEL UPGRADES & ADDITIONS

	PART NO.	AVAILABLE FOR SERIES					
		1125	1175	1185	1195	1275	1600
 <p>Wand Holder - Lightweight aluminum construction with black CPC™ powder finish. - 24" long with a 1.6" diameter, ideal to store pressure washing guns & other spraying devices. - Left, right, front & rear sides mount configuration.</p>	15735	•					
	16704			•	•	•	•
 <p>Bevel Crank Handle Holster Universal design mounts to either side of the reel with independent mounting holes. Features chained retaining pin to keep handle in place.</p>	HSRK-050 1/2" Hose	•					
	HSRK-075 3/4" Hose	•	•*				
 <p>Hose Strain Relief Kit - Allows the hose to be secured against the drum. - The clamp provides a strain relief when the hose is fully extended from the reel. - Allow the hose to be routed between the riser connection & the hose clamp with a proper bend radius.</p>	HSRK-100 1" Hose	•	•				•
	HSRK-100F 1" Forestry Hose	•	•				
	HSRK-125 1 1/4" Hose				•*		
	HSRK-150 1 1/2" Hose				•	•*	•

* With reducer (optional cap)

PORTABLE HOSE REEL CART

	PART NO.	AVAILABLE FOR SERIES			
		1125	1175	1185	1275
 <p>Portable Cart Steel round handle detaches for compact storage. Steel front legs with rubber feet prevent sliding. High grade ball bearings with hardened cup. 1/2" diameter steel axle. Solid 8" rubber tires. For 8" semi-pneumatic tires order part number beginning with PRP. Weight: 17 lbs.</p>	PR-1125-6 1125-4-100 1125-5-50	•			
	PRP-1125-6 1125-4-100	•			
	PR-1125-12 1125-4-200 1125-4-200-BYXX 1275-4-100				•
	PRP-1125-12 1125-4-200 1125-4-200-BYXX 1275-4-100	•			•
	PR-1175-11 1175-6-100 1175-6-100-BYXX 1185-1124			•	•
	PRP-1175-11 1175-6-100 1175-6-100-BYXX 1185-1124			•	•
	PR-1175-15 1175-6-150 1185-1524			•	•
	PRP-1175-15 1175-6-150 1185-1524			•	•
	PR-1125-HC	•			
	 <p>Carry Handles Easily bolts to "A" frame making the reel portable. 1" tube steel construction. Powder coated crinkle black. Weight: 8 lbs.</p>				

MOTORIZED













HAND CRANK







WARNING: Cancer and reproductive Harm – See page

ACCESSORIES *HAND CRANK & MOTORIZED REELS*



SPEED CONTROLLERS FOR MOTORIZED MODELS

	PART NO.	MOTOR OPTIONS							
		E	EB	ED	EA	EF	EJ	A	AB
 Explosion Proof Stationary Push Button Switch For 12V D.C. applications, must be used with solenoid. Cast 3/4" N.P.T. hub inlet.	20882	•							
 Vapor Proof Junction Box Includes box cover & gasket, has three 3/4" N.P.T. hubs.	20883	•	•	•	•	•			
 General Purpose Reversing Switch For direct starting & reversing of A.C. rewind motor.	15210				•				
 Sealed Push Button Switch Weather proof, dust proof momentary contact. To be used with solenoid. 30 AMP.	20876	•	•	•		•			
 Solenoid Relay 12V D.C. for activating motor.	20877	•		•					
 Circuit Breaker 50 amp automatic reset, circuit breaker. A circuit breaker is recommended for all 12V D.C. explosion proof motors.	20878	•		•					
 Switch Box (Includes #20876, #20877, & #20878 & all parts needed to assemble the entire switch box) - Casing is powder coated crinkle black.	8281	•		•					
 Electrical Box & Switch - Installs on any DC electric motor kit. - Push button switch mounts to frame. or to 3-Way Pin Lock. - Works with all guards and accessories.	16780-12 12 VDC	•		•					
	16780-24 24 VDC	•		•		•			
 115/230 AC/Volt Variable Speed Controller - 10-amp fuse. - On/off push button switch. - Forward/reverse feature.	20875				•				
 115/230 AC/Volt Variable Speed Controller - 10-amp fuse. - On/off push button switch.	20874				•		•		
 115/230 AC/Volt Variable Speed Controller • 10-amp fuse. • Switch not included	20873				•		•		
 12 Volt DC Electric Motor Variable Speed Controller On/off push button switch. • Relay, 50-amp circuit breaker. • Forward/reverse feature.	20872	•		•					
 12 Volt DC Electric Motor Variable Speed Controller On/off push button switch. • Relay, 50-amp circuit breaker.	20871	•		•					

SPEED CONTROLLERS FOR MOTORIZED MODELS

	PART NO.	MOTOR OPTIONS							
		E	EB	ED	EA	EF	EJ	A	AB
 12 Volt DC Electric Motor Variable Speed Controller • Switch not included	20870	•		•					
 Electric Motor Speed Controller • For AC motors • Fixed speed - 50% less	20868				•				
 Control Valve Control valve for No. 4 Gast Air Motor available upon request	15212							•	
 Control Valve Control valve for No. 6 Gast Air Motor available upon request	15212-1								•

SM SERIES MOUNTING BRACKET

	PART NO.	AVAILABLE ON
		SM
 Mounting Bracket Pivoting base for wall mounting only. Heavy gauge steel construction, powder coated crinkle black, includes rigid arm with 8-position locking pivot base. Weight: 8 lbs.	SMK-202	•
 Tube Mounting Bracket Pivoting base for tube mounting only. Heavy gauge steel construction, powder coated crinkle black, includes bent square tube arm with 8-position locking pivot base. Tube is 1 1/4" square 14 ga tube which slides into square tube receiver (Not included). A favorite mounting method used by trailer and cart builders.	SMK-502	•

DISTRIBUTORS MERCHANDISING DISPLAY

Coxreels Point of Purchase Merchandising Display is a proven "Sales Generator."

It has been tested & proven to increase sales. It's essential in demonstrating the controlled retraction of the EZ-Coil Safety line.

INCLUDES: Heavy-duty powder coated steel display rack, full color product specific hang tags, tri-fold brochures with mountable tri-fold holder & full-color display banner!

- Safe & Simple Demonstration Tool
- Creates Visual Impulse Purchases
- Mix & Match Up To Four Coxreels Models
- Durable Crinkle Black Powder-Coat Finish
- Adjustable Leveling Feet To Prevent Rocking
- Fast & Easy To Assemble
- No Additional Parts Necessary
- Offered Exclusively By Coxreels

Dimensions: 27" W x 58" H x 24" D

Weight: Aprx. 50 lbs

To get a P.O.P. display working for you, call Coxreels Customer Service Department at 1-800-269-7335 and order yours today!



 **WARNING: Cancer and reproductive Harm – See page**

GOODYEAR
RUBBER PRODUCTS, INC.

 **727-342-5088**

You can also email us at
GRP@goodyearrubberproducts.com

MOTORIZED

HAND CRANK

HOW TO ORDER

SELECTING THE PROPER REEL

THE SIZE, LENGTH AND TYPE OF HOSE TO BE HANDLED ARE PRIMARY FACTORS IN SELECTING THE PROPER REEL FOR YOUR JOB. THE FOLLOWING POINTS SHOULD BE CONSIDERED:

1. HOSE I.D., O.D. & LENGTH

When space permits, select a reel with greater hose capacity than you require. This allows you to rewind the hose with less care and keeps the hose well protected within the disc dimension, even if the hose is not wound in uniform coils. (See hose selection chart below)

2. SIZE & TYPE OF SWIVEL JOINT & SEAL FOR INLET & OUTLET

In selecting your reel please note the size of your hose versus the inlet and outlet sizes. Reducing your fitting and hose size will allow for more hose capacity. Please refer to the o-ring seal compatibility chart on page 52 for special application requirements.

3. RETRACTION METHOD & PROPER USE

Choose from Spring Driven, Hand Crank or Motor Driven retraction.

SPRING DRIVEN: Automatic rewind requiring no power source. Operator is to guide the hose or cord as it self-retracts and wraps around the drum.

For models to be mounted 15 feet above the floor, consult factory and specify on P.O.'s for proper spring retraction motor.

HAND CRANK: Operator must manually crank the reel and guide the hose or cord evenly as it wraps around the drum to reach full capacity.

MOTOR DRIVEN: Requires a power source to operate in AC, DC, Air or Hydraulic power. On/Off switches and speed controllers are available to help control retraction speed. You must guide the hose or cord efficiently back on the reel to reach full capacity.

4. MOUNTING POSITION

Determine which mounting position you require. All reels are shipped in the floor-ceiling mount (F) position with the exception of the "T," "EN," and "SD" Series, which are shipped in the wall-truck mount (W) position. See diagram to the right for the "SP & DP" Series as well.

5. CHOOSE TYPE OF HOSE

Consider temperature, product type and pressure required (PSI).

Always use good quality hose rated for the service and operating pressure required. Poor quality hose tends to expand and contract under pressure surges. When this happens, hose remaining on the reel may bind and become difficult to handle. In extreme cases, poor quality hose may expand under pressure to the extent that the reel becomes distorted and inoperable.

6. ADDITIONAL OPTIONS

Customize your reel to meet your exact requirements. Once you select your reel type consider the different add-on features such as roller brackets, special mounting brackets, carry handles or a cart for portability. See the options available indicated on each page.

E-MAIL INFORMATION

If you would like more information, feel free to e-mail us concerning your order or general questions you may have.

For general info or questions:
info@coxreels.com

For technical assistance:
techassist@coxreels.com

HOSE SELECTION

The drawing below shows two reels with different shapes and dimensions but with identical hose capacity. In most cases, more than one reel will handle the size and length of hose you need, so you can specify a reel to fit your space requirements.

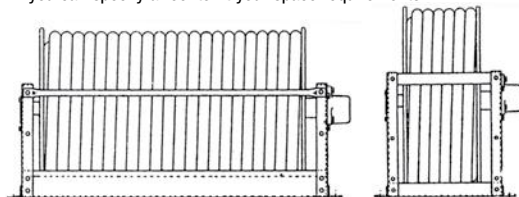

See Page 52 For Hose Assemblies & Component Parts

BASIC INFORMATION

The diagram below indicates the basic information which should be determined before ordering.

Caution! Failure to use flexible connector between the inlet pipe and swivel joint will invalidate our warranty.

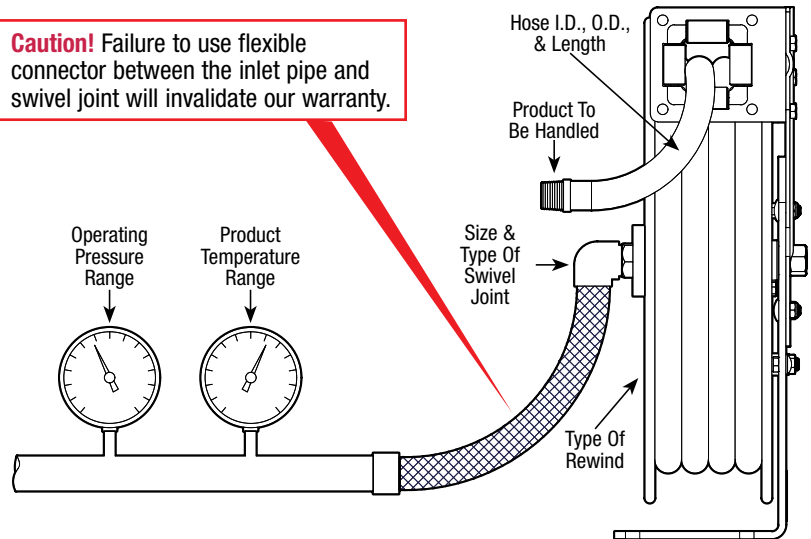

MOUNTING POSITIONS

The diagrams below indicate the mounting positions which should be determined before ordering.

ALL MODELS with the exception of the SP & DP Series

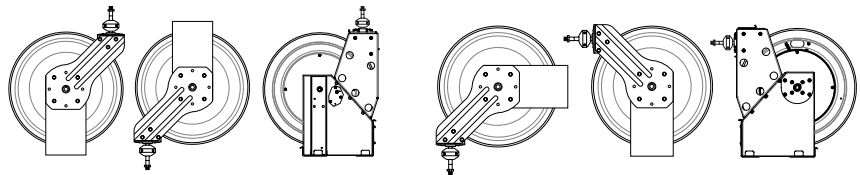

"F" Floor-Ceiling Mount

All reels are shipped in this position unless specified with the exception of the T, XTM, EN, SD, SP & DP Series

"W" Wall-Truck Mount

T, EN & SD Series are shipped in this position unless specified

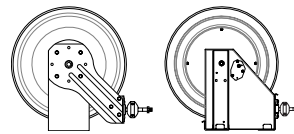

"B" Bottom-Truck Mount

XTM Series is shipped in this position unless specified

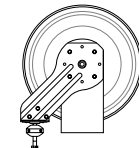

"D" Down Mount

SP & DP SERIES

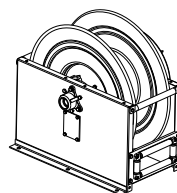

Standard Mount (Drag)

All SP & DP Series are shipped in this position unless specified

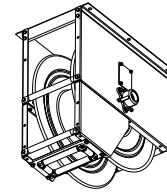

"BXIX" Ceiling Mount (Lift, Stretch Or Recover)

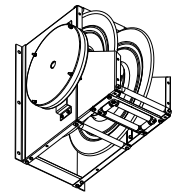

"BXCX" Wall Mount (Lift)

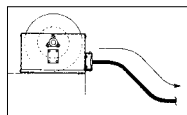

DRAG
With Roller Guide

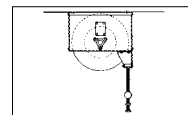

LIFT
With Roller Guide

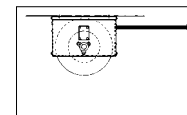

STRETCH
With Or Without Roller Guide
Special Spring Motor Required,
Consult Factory

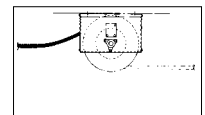

RECOVER
(Pick-up) No Roller Guide Needed,
Special Spring Motor Required,

CUSTOMIZE YOUR REEL

Customize your reel with Coxreels Custom Products:

Our engineering capabilities and manufacturing processes allow us to design and build top quality products for any conceivable application where reels are needed.

- Customize fluid paths/axles or create custom brackets, mounts, and accessories.
- Integrate with your specific hardware, systems, or devices.
- Create custom retraction systems.
- The possibilities are only limited by your imagination!
- Combine features of various reel model lines, creating your own hybrid reel.
- Increase temperature and pressure capabilities, or multiply fluid paths.
- Modify drums, add divider disks, manipulate openings, or integrate hosehandling devices.

CPs & CCRs :: Coxreels offer two types of custom products. CCRs and CPs each offer specific benefits to our customers.

CCRs or Cox Custom Reels are custom reels assembled out of existing components. CCRs allow customers to combine features of various reels and create completely new reel lines. CCRs range from simple request of swivel size changes and hose combinations to a new dual hose side mount reel built by combining our MPD-N-430 with the mounting of a SG17-430.

CPs or Custom Products are custom reels that fall into a more demanding category that allows customers to request completely custom components and assemblies specific to their application. CPs include simpler items like custom powder coat colors and new special hoses and also more complex requests in the vein of new interfacing brackets and frames, or divider disks and even new mounting bases. CPs allow OEMs, factories, and industry specific companies to get a leg up on their competition by having a reel incorporated into their product or service only available to them. Match the right color, incorporate your own drive system, or develop a new product just for you!

POWDER COAT OPTIONS*



-BXX or -BXXX
Blue



-RXX or -RXXX
Red



-GXX or -GXXX
Gray



To add any of these options to your designated reel simply add the option number to the suffix of the model number. 3 digit suffix for spring driven or 4 digit suffix for hand crank and motorized models. Consult factory for custom color match.

To order a 1125-4-200 with green color, simply suffix the option model number on the reel model number Example: 1125-4-200-**NXXX**



-KXX or -KXXX
Gloss Black



-CXX or -CXXX
Crinkle Black

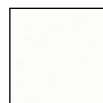

-WXX or -WXXX
White



-NXX or -NXXX
Green



To order a P-LP-350 with black color, simply suffix the option model number on the reel model number Example: P-LP-350-**KXX**

*Minimum quantity & or dollar amount may apply

POPULAR OPTIONS TO CUSTOMIZE YOUR REEL

To add any of these options to your reel simply suffix the option number after the model number. Consult factory for more options.

for SPRING DRIVEN REELS

- “-BVX” ... Change to Viton® seals
- “-BAX” ... Change to stainless steel fluid path & nitrile seals
- “-BBX” ... Change to stainless steel fluid path & Viton® seals
- “-BWV” .. Change to stainless steel swivel with food grade seals & non-toxic grease
- “-BVB” ... Add bend restrictor to hose
- “-BVC” ... Add Constant Tension (No latching mechanism)

To order a P-LP-350-HV with a bend restrictor simply suffix the option model number on the reel model number

Example: P-LP-350-HV-**BXB**

for HAND CRANK & MOTOR DRIVEN REELS

- “-BVXX” ...Change to Viton® seals
- “-BAXX” ...Change to stainless steel fluid path & nitrile seals
- “-BBXX” ...Change to stainless steel fluid path & Viton® seals
- “-BDXX” ...Change to stainless steel swivel with food grade seals & non-toxic grease
- “-BVCX” ...Top 4-way rollerbracket



2 YEAR WARRANTY

Products manufactured by Coxreels are warranted for a period of two years from the date of sale to original purchaser. If within such warranty period any such equipment is proved, to Coxreels' satisfaction, to be defective, Coxreels shall be liable for the repair or, at Coxreels' option, replacement when the product is returned, freight prepaid, to Coxreels' plant or a Coxreels' service dealer. Coxreels' obligation hereunder shall be confined to such repair or replacement and shall be further conditioned upon Coxreels receiving written notice of any alleged defect within ten days after its discovery. Coxreels assumes no responsibility for improper choice of models or where products are used in excess of rated capacities and design functions, or under abnormal conditions. We make available a free engineering service to help with any product selection, application or problem.

Warranty is void if the product or any part thereof has been tampered with, altered, or repaired by other than authorized service personnel. Coxreels' responsibility ceases upon delivery to any common carrier, and we do not, unless previously instructed, insure shipments beyond point of delivery to such carrier. Any products, components or accessories that are not manufactured by Coxreels and are supplied by other manufacturers are subject to their respective guarantees or warranties. Certain products will carry their own warranties. Equipment specially built to customers' specifications and requirements is not subject to cancellation nor returnable for credit under any condition. We reserve the right to modify or alter materials, dimensions, design and construction, when necessary, to improve performance.

RETURN POLICY

No material will be accepted for return without written authorization by the factory, and a return goods authorization number assigned. Materials must be returned prepaid. A 20% restocking fee and a \$5.00 repacking charge normally applies. No material will be accepted for a credit after one year from the date of purchase. Custom products and special orders are not returnable.

STATEMENT OF HOSE APPLICATIONS

Coxreels does not manufacture any hose. All hose supplied by Coxreels is selected from reliable commercial sources and is recommended for application on the basis of data supplied by the manufacturer. Coxreels assumes no responsibility for any other application or use. Hose supplied by Coxreels carries the warranty as listed by the manufacturer (90 days).

TERMS

- Net 30 days on approved credit
- Minimum billing \$25.00
- Service charge 11/2% on past due accounts

FREIGHT

- F.O.B. Factory
- Our responsibility ceases upon delivery to common carrier. Consignee must file claim for shortage and damaged freight with the carrier.

DELIVERY

- Most standard items are shipped in five - ten business days or less. Consult customer service for availability.



Coxreels' Customer Service - 1.800.269.7335

Call and request a Returned Merchandise Authorization# (RMA #). Warranty claims must be made by authorized Coxreels distributors. Be prepared to give the following information: product model number, serial number and purchase invoice number.

- Replacement parts ordered will be invoiced to your account.
- Once given an RMA #, you must write it on all boxes and paperwork. Coxreels will not accept your return without an RMA #.
- Upon receiving the return, if it is determined to be covered under warranty, a credit memo will be issued and mailed to you for your records.



PLEASE REVIEW ALL SAFETY INFORMATION BEFORE CHOOSING AND USING ALL EQUIPMENT

SERIOUS INJURY, DEATH AND DESTRUCTION OF PROPERTY can result from improper selection or improper use of products described in this catalog. Since COXREELS has no control over the number and variety of applications for which its products may be purchased or the conditions under which they may be used, COXREELS liability on any claim, whether in contract, tort (including negligence), or otherwise, for any loss or damage shall in no case exceed the price paid for product or any part thereof which give rise to claim. However, the general information contained herein shall allow the customer to select and assume all responsibility for product acceptability and fitness for specific applications. As always, COXREELS technical assistance and support is available for your convenience.



WARNING - USER RESPONSIBILITIES

The customer, installer, and end users shall, through analysis and testing, assume sole responsibility in making the final selection of reels and accessories. Furthermore, these parties shall hold COXREELS harmless for all liability, claims, suits, and expenses incurred. These parties shall ensure training, performance, endurance, routine inspections, maintenance, safety precautions and warnings regarding the application are enforced at all times. COXREELS is not responsible for use of products in excess of rated and recommended capacities, design functions, or abnormal conditions.



CAUTION - PROPER SELECTION OF ACCESSORIES

Coxreels offers a wide variety of accessory items and optional features for its reels. It is the sole responsibility of the customer, installer, and end users to ensure that the proper items and features have been selected to fit the application. Consult with Coxreels technical support for available accessories and optional features which will help you to keep your product safe in its environment. These items may include mounting brackets, guards, guides, and electrical components.



WARNING - FOLLOW INSTRUCTIONS

The customer, installer, and end users shall ensure that all potential users of these products receive continual training and access to all relevant product manuals and safety instructions. This information should be thoroughly reviewed prior to installation, stored and reviewed continually during use of the product. Coxreels assumes no responsibility for fitness of installation

and continued use in specific applications. Any overhead installations should be such that the reel is not supported solely by bolts under tension. A safety chain or cable is necessary to eliminate potential for damage or personal injury.



IMPORTANT - FOLLOW GOOD MAINTENANCE PRACTICES

When receiving your products, establish a program for inspection, testing, and periodic replacement of worn items depending on factors such as; severity of application, frequency of equipment use, and past performance indicators. Use only properly trained persons to perform these duties. Update training periodically. Document the maintenance, inspections, and testing of products. Never allow an improperly functioning reel or accessory product to be put into use.

Documented inspections shall include in part, pressurized units, swivel joints, hose, hose fittings, cable, mounting hardware, roller guides and any such moving parts. Never allow the use of hoses or cables other than what is intended in the design of the reel. Changes in diameter, weight, length, or flexibility can affect the function and may cause damage or personal injury. Consult specific product manuals, or factory, with any questions regarding proper maintenance practices.

The use of any replacement components other than those provided by Coxreels is prohibited. Coxreels shall be held harmless from any improper selection of such components which may affect function and overall safety of the product.

NOTE: All designs, specifications, and dimensional data contained in this book are subject to change without notice. No additional warranties, express or implied, including warranties of merchantability for fitness for a particular purpose, are created by the descriptions and depictions of the products on in this book.



PROP 65

In compliance of California's Proposition 65, Coxreels will be applying warning labels to all applicable products with regard to chemicals known to the state of California to cause cancer or reproductive harm.

All reels will carry the following warning.

Parts and components will carry warning labels relative to the respective materials used.

For more information see <http://www.coxreels.com/prop65.html>



WARNING

This product can expose you to chemicals including nickel, which are known to the State of California to cause cancer, and chemicals including chromium, which are known to the State of California to cause birth defects or other reproductive harm.

For more information: www.P65Warnings.ca.gov/product



COXREELS®



CORPORATE HEADQUARTERS:

Tempe, Arizona USA

Phone: 480.820.6396 Fax: 480.820.5132

Toll Free: 800.COX.REEL Toll Free Fax: 800.229.REEL

www.coxreels.com info@coxreels.com



INTERNATIONAL:

EUROPE / MIDDLE EAST / AFRICA

Phone: +44 (0) 1536 464 990

Fax: +44 (0) 1536 464 999

www.crireels.com sales@cireels.com



GOODYEAR
RUBBER PRODUCTS, INC.

☎ 727-342-5088

You can also email us at
GRP@goodyearrubberproducts.com