



Fittings, Materials and Tubing Guide

Instrumentation Products

aerospace
climate control
electromechanical
filtration
fluid & gas handling
hydraulics
pneumatics
process control
sealing & shielding

Contents

Page 3-6 Problems of Corrosion

Page 7 Facts of Corrosion

Page 8-12 The Parker Solution

Page 13-19 Parker Grade Tube

Page 20-33 Suparcase and Materials

Page 34-106 A-LOK®/CPI™ Fittings

Page 107 Assembly and Re-make instructions

Page 108-134 Instrument Pipe and ISO Fittings

Page 135-141 10k Pipe Fittings

Page 142-176 Phastite® Fittings

Page 177-203 MPI™ Fittings

Page 204-213 Tube Fabricating Equipment

Page 214-218 Complementary Products

Page 219-220 Notes

Page 222-223 Offer of Sale

For the customers & markets that we serve, Corrosion represents the difference between trouble-free operation and costly downtime.

What is Corrosion?

According to NACE, Corrosion is the deterioration of a substance, usually a metal, or its properties because of a reaction with its environment.

The Problem of Corrosion

Direct and indirect economic losses derived from corrosion include the following:

- Replacement of damaged equipment
- Overdesign to allow for corrosion
- Preventive maintenance
- Shutdown due to corrosion failure
- Loss or contamination of the product being produced (i.e. food industry)
- Efficiency decrease. For example, corrosion products lower the heat transfer rate in heat exchangers
- Failure of adjacent equipment
- Health and safety. Loss of natural resources, pollution or even human lives.



Cost of Corrosion

According to a nationwide report conducted in the USA, the cost of corrosion accounted for a total of \$276 billion per year. The specific industrial sectors and associated cost were broken down as follows:

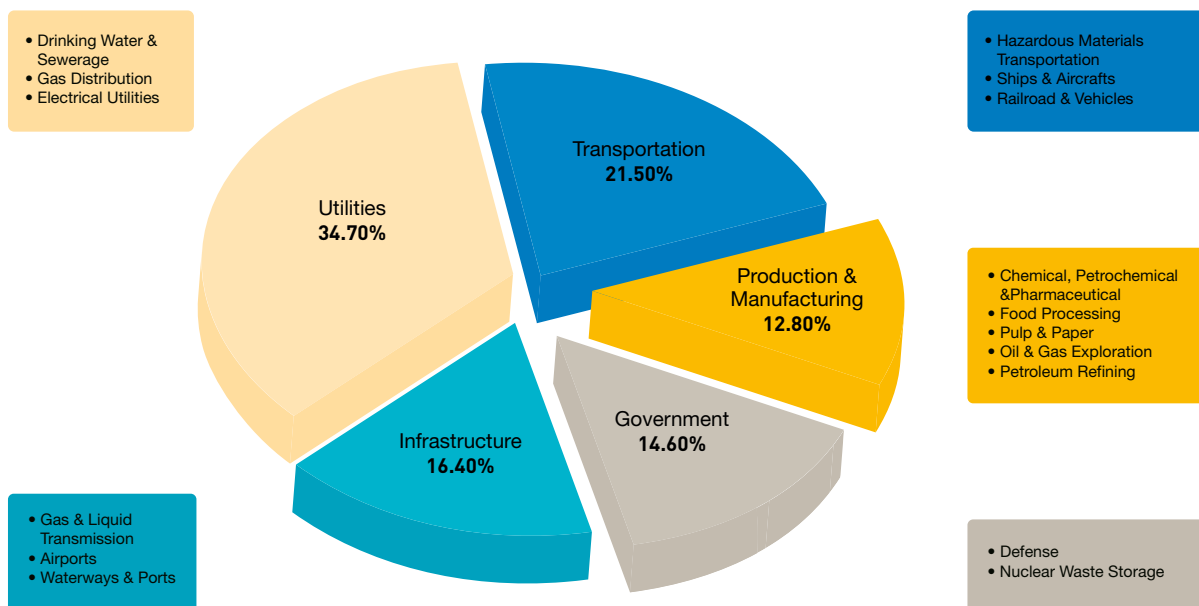

Using the right materials and processes can help to beat corrosion problems throughout the industries we serve.

Uniform Corrosion

Uniform or general corrosion is the most classical form of corrosion, but is not always the most important in terms of cost or safety.

The consequences of uniform corrosion are a decrease in metal thickness per unit time or a more

or less uniform deposit of these corrosion products in the surface of the metal.

Uniform corrosion can be limited or prevented by an appropriate choice of material or modification of the medium among other solutions.



Galvanic Corrosion

Galvanic corrosion can be defined simply as being the effect resulting from the contact between two different materials in a conducting corrosive environment.

In many cases, galvanic corrosion may result in quick deterioration of the least corrosion resistant

material, and can lead to fatal failure.

Common methods of minimising and preventing galvanic corrosion are choosing material combinations in which the constituents are all made from the same material or different materials as close as possible

in the corresponding galvanic series, avoiding an unfavourable surface area ratio, using protective coatings, or controlling the aggressiveness of the environment.

> **LESSON:** Do not mix tube and fitting or valve alloys wherever possible.



Galvanic reaction created by mixing different body & nut materials.

Crevice Corrosion

Crevice corrosion is an electrochemical oxidation-reduction process, which occurs within localized volumes of stagnant solution trapped in pockets, corners or beneath a shield (seal, deposit of sand, gasket or fastener, for instance).

Crevice corrosion is highly accelerated if chlorine, sulphide or bromide ions are present in the electrolyte solution. Once a

crevice is initiated, even the most benign atmospheric environments can become extremely aggressive. Crevice corrosion is considered much more dangerous than uniform corrosion as the corrosion rate can be up to 100 times higher.

Crevice corrosion is encountered particularly in alloys which owe their resistance to the stability of a passive film. A classic example is stainless steel in the presence of

moderate to high concentrations of chlorine ions.

Crevice corrosion can be limited or prevented by using welds rather than bolted or riveted joints, designing installations with a proper draining system and avoiding stagnant areas, using solid and high quality seals or controlling the severity of the electrolyte.



Crevice corrosion between the tube/tube trap interface.



Pitting Corrosion

Pitting is characterised by the localised attack in the form of deep and narrow holes that can penetrate inwards extremely rapidly, while the rest of the surface remains intact. A component can be perforated in a few days with no appreciable loss in weight on the structure as a whole.

Pitting corrosion is most aggressive in solutions containing chloride, bromide or hypochlorite ions. The presence of sulphides and H₂S is also detrimental to this type of attack. The stainless steels are particularly sensitive to pitting corrosion in seawater environments.

Pitting corrosion can be reduced or prevented by choosing the most appropriate material for the service conditions, avoiding stagnant zones and deposits, reducing the aggressiveness of the medium or using cathodic protection.

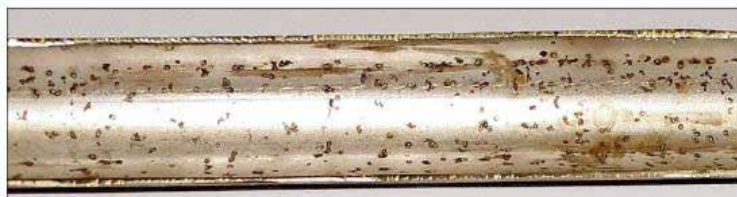

> **LESSON:** Every batch of Parker 6Mo steel is tested for Pitting Corrosion as per the ASTM G48 standard.

Intergranular Corrosion

Intergranular corrosion is a form of attack that progresses preferentially along the grain boundaries paths and can cause the catastrophic failure of the equipment, especially in the presence of tensile stress. Under certain conditions, the grain boundaries can undergo marked localized attack while the rest of the material remains unaffected. The alloy disintegrates and loses its mechanical properties. This

type of corrosion is due either to the presence of impurities in the boundaries, or to local enrichment or depletion of one or more alloying elements.

Many alloys can suffer from intergranular attack, but the most common example is the intergranular corrosion of austenitic stainless steels, related to chromium carbide depletion in the vicinity of the boundaries,

during a “sensitising” heat treatment or thermal cycle.

Intergranular corrosion can be prevented by selecting the right material, avoiding low cost equipment where the material is likely to have impurities and poor heat treatment, using low carbon or stabilised grades if welding or applying post-weld heat treatments correctly.

> LESSON: Our stainless steel is capable of passing the intergranular corrosion test as per the ASTM A262 Practice.

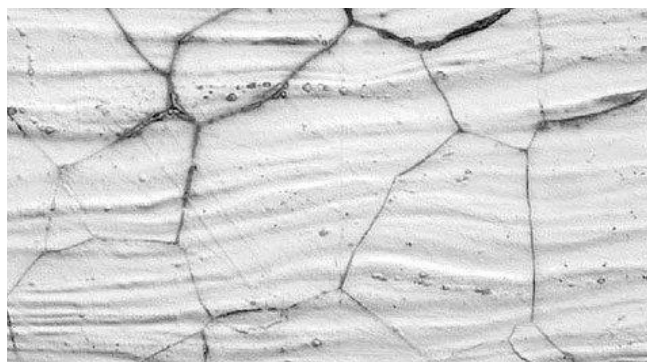

Intergranular Corrosion – HAZ Area – Stainless Steel Weld in Seawater Environment



Stress Corrosion Cracking Stainless Steel in Seawater Environment

Stress Corrosion Cracking

Stress corrosion cracking (SCC) is a process involving the initiation of cracks and their propagation, possibly up to complete failure of a component, due to the combined action of tensile mechanical loading and a corrosive medium. The time necessary for a part to fail by SCC can vary from a few minutes to several years.

This kind of attack normally occurs in media that are little or non-aggressive towards the metal or alloy concerned in the absence of tensile loading. This form of corrosion is of a paramount

importance and represents a permanent risk in numerous industrial installations, in terms of both the safety and economic consequences involved. No commercial alloy is fully immune to SCC.

Stress corrosion can be avoided by selecting materials that are not susceptible in the specific corrosion environment and minimised by stress relieving or annealing after fabrication and welding, avoiding surface machining stresses and controlling the corrosive environment.

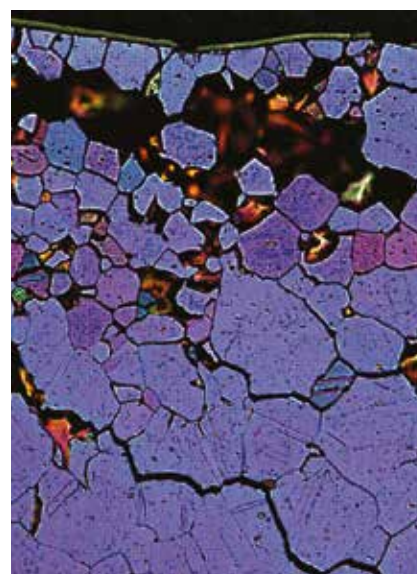

> LESSON: Do not take shortcuts. Select the best material for a safer & more cost effective application.

The Facts

Some of the most popular factors that can have a significant influence in terms of corrosion are listed below:

- **Materials Selection:**
 - Environment
 - Mechanical Properties
 - Availability of Design & Test Data
 - Cost
 - Availability
 - Maintainability
 - Compatibility with other components
 - Reliability
 - Appearance
- **Process Parameters:**
 - Media Chemistry
 - Temperature
 - Velocity
 - Pressure
- **Construction Parameters:**
 - Drainage, Welding, etc.
- **Dissimilar Metals**
- **Crevices**
- **Corrosion Allowance**
- **Operating Lifetime**
- **Maintenance & Inspection Requirements**

Some Figures About Corrosion

The industrial importance of localized corrosion problems has been revealed in many reports. The following pie chart summarizes the findings of 363 corrosion failure cases investigated in a major chemical processing company. The importance of pitting comes second, just after general corrosion and before stress corrosion cracking which is often also initiated by pitting.

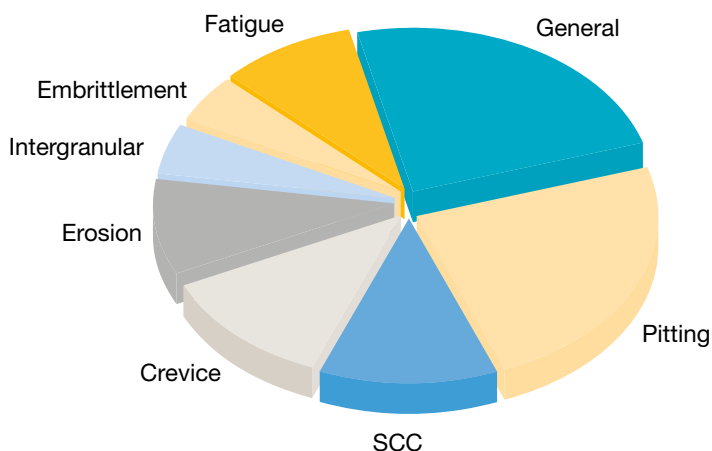

Sour Gas Service and NACE MR0175

Hydrogen sulphide (H₂S) is a colourless, flammable, and extremely hazardous gas. It occurs naturally in crude petroleum, natural gas, and hot springs. In addition, hydrogen sulphide is produced by bacterial breakdown of organic materials and human and animal wastes (for instance, sewage systems). Industrial activities that can produce the gas include petroleum/natural gas drilling and refining, wastewater treatment, coke ovens, tanneries, and paper mills. Hydrogen sulphide can also exist as a liquid compressed gas.

When dissolved in water, H₂S forms a weak acid which is extremely corrosive, especially in the case of steel where the

corrosion products of iron, sulphide and atomic hydrogen can penetrate the steel and embrittle it. Under the influence of applied stresses, cracking can develop in a very short time and result in failure of the equipment and potential human and environmental loss. This type of failure is known as sulphide stress corrosion cracking (SSCC) and there are many cases in history that account for this type of failure.

NACE MR 0175/ISO 15156 is a Materials Standard issued by the National Association of Corrosion Engineers. It aims to assess the suitability of materials for oilfield equipment where sulphide stress corrosion cracking may be a risk in hydrogen sulphide (sour) environments. This 3-part

document gives requirements and recommendations for the selection and qualification of carbon and low-alloy steels, corrosion-resistant alloys, and other alloys for service in equipment used in oil and natural gas production and natural gas treatment plants in H₂S-containing environments, whose failure could pose a risk to the health and safety of the public and personnel or to the environment. It can be applied to help to avoid costly corrosion damage to the equipment itself.

Parker Instrumentation can offer all the range of materials compliant to the metallurgical requirements of NACE MR0175 in selected ranges. For more information, please contact us.

The Solution

Corrosion control does not just happen. It must be planned. We can help you find the best solution for your application.



As the worldwide search for oil and gas, power generation or chemical production is turning to more challenging applications an increasing number of situations are being encountered where corrosive production environments and products are present. Many of these cases often involve significant amounts of hydrogen sulphide, carbon dioxide, brine or hazardous chemicals among others, where their high corrosivity along with the wrong decisions made during the design stage have often lead to fatal failure and

invaluable human, environmental and economic loss. In most cases, these situations could have been avoided by properly analysing the specific operating parameters and designing the most suitable equipment.

In addition, other factors such high pressures and temperatures or severe environments are on demand. Requirements for higher production rates or more complex processes along with climate change and new environmental regulations can complicate the

material selection process and ultimately the performance and integrity of the application. Under these circumstances materials can offer a valid and cost effective alternative to conventional methods of corrosion control.

The material selection process can sometimes become complex, usually involving multiple factors like high strength requirements, operating temperature, high corrosion resistance, availability and cost.

Material Compatibility

The most important consideration in the selection of suitable tubing for any application is the compatibility of the tubing material with the media to be contained.

Consideration should also be given to the maximum and minimum operating temperatures for the different tubing materials.

Due to thermal expansion characteristics and chemical stability, Parker instrument fittings are designed to work on like materials.

The practice of mixing materials is strongly discouraged. In general, dissimilar materials in contact may be susceptible to galvanic corrosion.

Further, different materials have different levels of hardness, and can adversely affect a successful seal on the tubing.

Materials Range for Corrosion Control

Our experienced credentials in materials selection are the results of years of expertise in successful applications worldwide.

Materials Range

Parker offers the most extensive range of alloys in the market. The range varies from conventional steels to high nickel alloys and titanium for the most demanding applications. The table below depicts the standard range of materials per product family. Other alloys might be offered on request.

	A-LOK® Fittings	MPI™ Fittings	CPI™ Fittings	Phastite® Fittings	Valves	Manifolds	Flanged Products
Brass	Yes	No	Yes	No	Yes	No	No
Carbon Steel	No	No	Yes	No	Yes	No	Yes
Stainless Steel 316/316L	Yes	Yes	Yes	Yes	Yes	Yes	Yes
Duplex Steel	No	No	No	No	Yes	Yes	Yes
Superduplex Steel	No	No	No	No	No	Yes	Yes
Super austenitic 6Mo	Yes	No	Yes	No	Yes	Yes	Yes
Monel 400	Yes	No	Yes	No	Yes	Yes	Yes
Alloy 825	Yes	No	No	No	Yes	Yes	Yes
Alloy 625	Yes	No	No	No	Yes	Yes	Yes
Alloy C-276	Yes	No	Yes	No	Yes	Yes	Yes
Titanium	Yes	No	Yes	No	Yes	Yes	Yes

Parameters To Be Considered in the Materials Selection Process

The main parameters to be considered when selecting any equipment are:

- Operating conditions, including temperature, pressure and media contained
- Environment
- Legislation and Internal Regulations
- Cost
- Availability
- Lead time
- Expected life time of the equipment
- Safety

In terms of materials, the selection criteria normally translate into some of the following parameters:

- Mechanical properties
- Corrosion resistance to media and environment
- Temperature operating range
- Cost
- Availability on request

Although the mechanism of corrosion is highly complex the actual control of the majority of corrosion reactions can be effected by the application of relatively simple concepts. Indeed, the Committee on Corrosion and Protection concluded that 'better dissemination of existing knowledge' was the most important single factor that would be fundamental in decreasing the enormous cost of corrosion in the UK.*

* Report of the Committee on Corrosion and Protection, Department of Trade and Industry, H.M.S.O. (1971)

Materials Quick Selection Guide for General Industrial Applications

The following table classifies our materials range in terms of mechanical strength and general corrosion resistance, and aims to be a generic tool and guidance at an early stage of the design. The values given to the specific parameters are not absolute and should be used as a reference only. Each application needs to be evaluated carefully and individually as the rules below might not apply at all times.

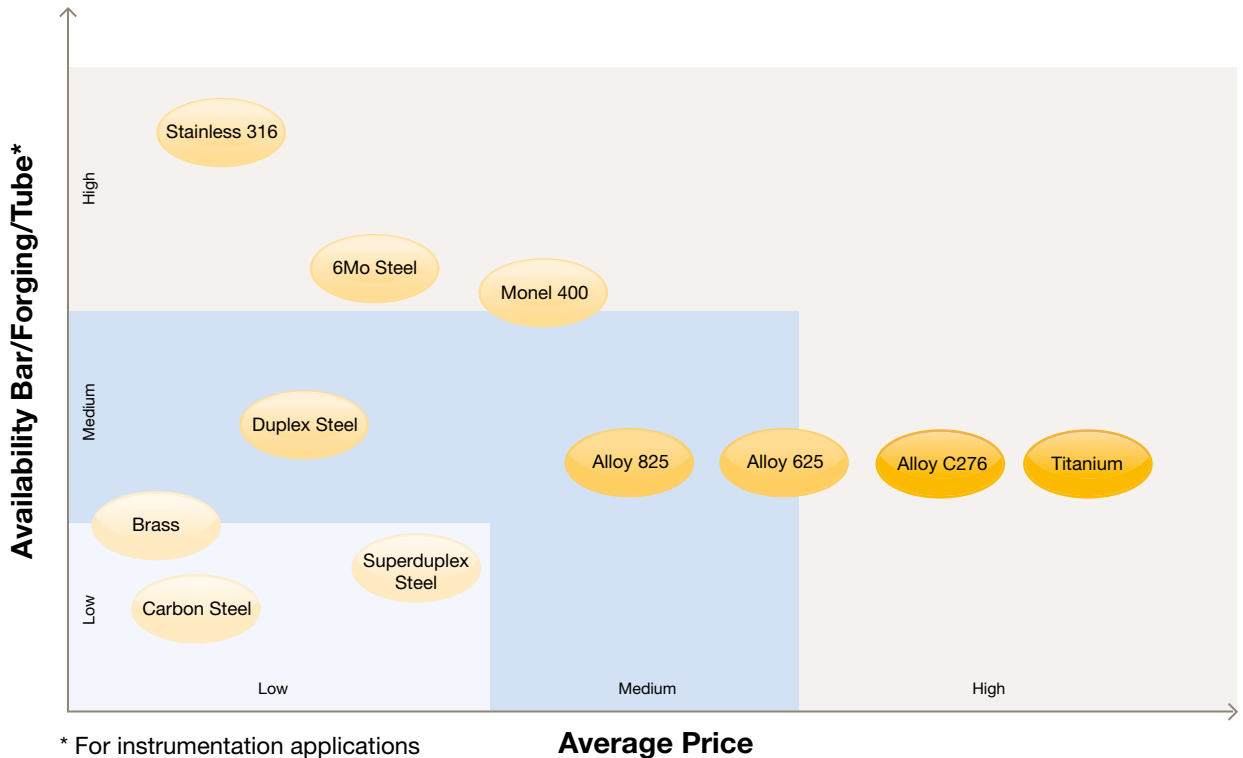
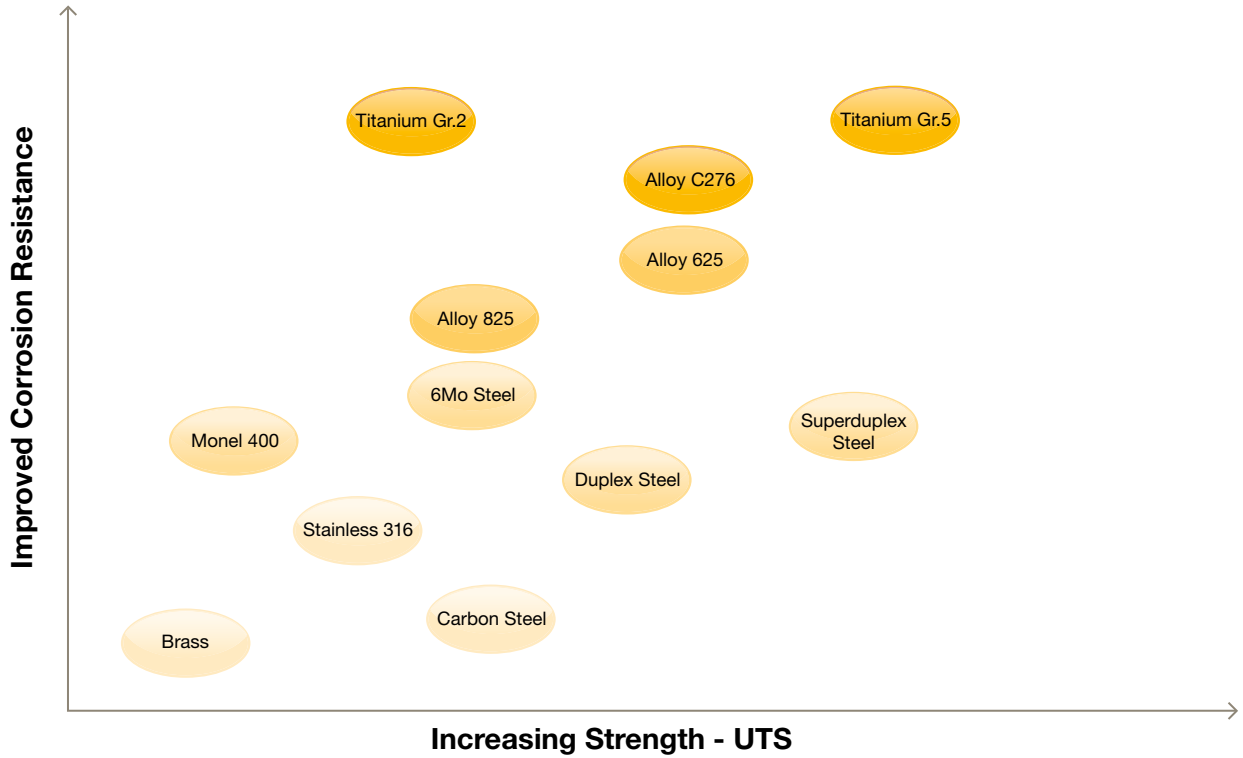

* For instrumentation applications

Cost Considerations

Think of the equipment replacement cost, depreciation, re-qualification of the new systems, downtime or low production rates, fines or human and environmental loss. Avoid low cost equipment. Investing in a more expensive material today could be a cheaper and trouble-free solution in the medium and long term.

Parker Hannifin carried out Stress Corrosion Cracking Testing as per ASTM G36 conducted by an independent party and its aim was to determine the time to failure of the 6Mo super austenitic steel (UNS S31254) and the conventional 316/L stainless steel (UNS S31600/03) in exactly the same conditions. Results showed that the 6Mo grade took over 3

times more to fail than the 316 grade.

In service applications, those results translate into a life expectancy of 6Mo three times longer than that of 316 in the same given conditions, **reducing leakage and downtime and increasing safety by over 60%.**

Example of a typical installation and associated life cycle cost:

		Materials Selection A: Stainless Steel 316	Materials Selection B: Superaustenitic 6Mo
Initial Installation	8,000 meters of 1/2" x 0.065" tubing	\$7/m	\$23/m
	1,500 Fittings 1/2" x straight shapes	\$15/unit	\$40/unit
	Design Parameter	5 Years Life	15 Years Life
After 5 Years	Tubing & Fitting Replacement**	Tube: \$7/m Fitting: \$15/unit	\$0
	MHR Labour Cost	40 MHR per 300 meters	\$0
		\$80 labour/hour	\$0
After 10 Years	Tubing & Fitting Replacement**	Tube: \$7/ft Fitting: \$15/unit	\$0
	MHR Labour Cost	40 MHR per 300 meters	\$0
		\$80 labour/hour	\$0
TOTAL		\$406,380	\$244,000

** Figures exclude material cost increase

40% cheaper

Check List of Design Parameters

Here are some basic guidelines based on our extensive knowledge and experience in applications worldwide:

- Think about cost effectiveness, safety and reliability
- A cheap option today usually translates into high cost of ownership tomorrow
- Do not mix tube and fitting/ valve alloys whenever Possible
- Use 6Mo for high pitting/ crevice corrosion performance
- Use Super Duplex for its tensile strength
- Use our range of exotic materials for demanding applications and NACE compliance

Let us help you select the best solution for your application. Start thinking **smarter, faster, cleaner** and **safer**.



For a successful and prolonged corrosion-free service, make sure the following parameters are checked during the design stage:

✓	Operating conditions, including temperature, pressure and media contained
✓	Environment
✓	Legislation and Internal Regulations
✓	Cost
✓	Availability
✓	Lead time
✓	Expected life time of the equipment
✓	Safety

Specify Parker Grade Tube

In any instrumentation application, one of the first steps to ensuring safety and reliability is to select the right tubing for your process.

Parker's instrument tube fittings have been designed to work in a wide variety of applications that demand the utmost in product performance.

Although Parker's Instrument tube fittings have been engineered and manufactured to consistently provide this level of reliability, no systems integrity is complete without considering the critical link, **tubing**.

Whilst it is the responsibility of the system designer/user to ensure the correct specification of materials and tube to ensure system integrity, this brochure is intended as a guide to assist the designer in properly selecting and ordering quality tubing and details the compatibility of selected tubing with Parker fittings.

Proper tube selection and installation, we believe, are key ingredients in building leak-free reliable tubing systems.

The following parameters should be considered when designing a leak-free system and ordering tubing for use with Parker tube fittings:

- Tubing Hardness
- Tubing Wall Thickness
- Tubing Surface Finish
- Material Compatibility

Tubing Hardness: Remember Parker Instrumentation Tube Fittings are designed to work within specific hardness ranges. Fittings are designed so the differential hardness between tube and fitting are optimum for a reliable and trouble-free operation. For specific values of our alloy portfolio and to understand the compatibility of a selected tubing

with our ALOK/CPI fittings, refer to the allowable pressure working tables (1-14), on pages 22-31. As a general rule, tubing must be suitable for bending and flaring.

Tube Wall Thickness: Proper wall thickness is necessary to accommodate accepted safety factors relative to desired working pressures.

Tube Surface Finish: As best practice, it is fundamental to control the tubing finish and straightness.

Always select tubing free of visible draw marks or surface scratches. If possible, cut off any undesirable sections. These 'deep' scratches can cause leaks when attempting to seal low-density gases such as argon, nitrogen, or helium. In addition, tubing shall be reasonably straight and ends must be smooth and free of burrs or any other imperfections.

* For materials not covered in this brochure, please contact us directly.

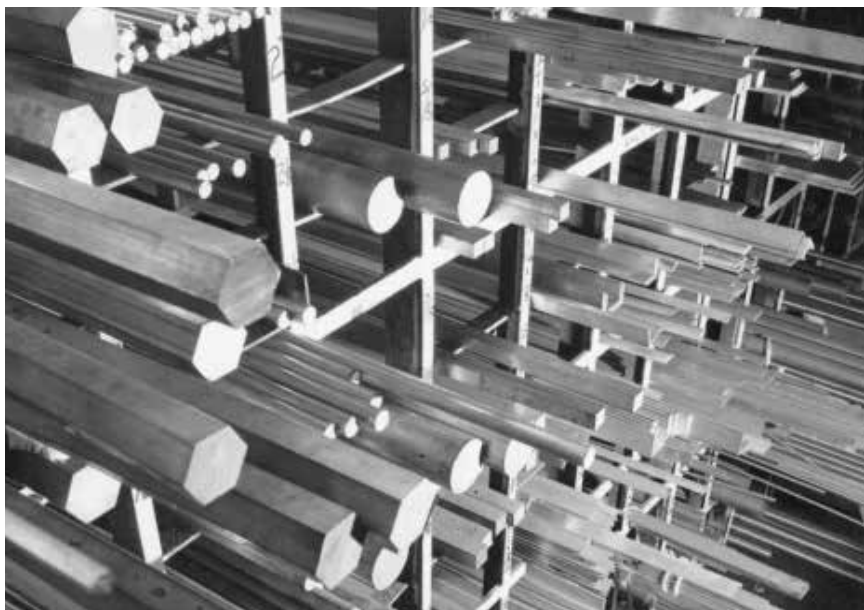

Picture of a low cost product. Corrosion damage created by a low quality hardening process applied to the back ferrule

Tube Part Numbers

Listed below are some of our popular tubing requirements, we also can supply Super Duplex, 625, 825 and Titanium tube

Description	Unit of Measure	Material	Parker IPDE Part	Description	Unit of Measure	Material	Parker IPDE Part
1/4" OD x .028"	MT	316/316L	TUBE-316-1/4 OD X .028	6mm OD x 1.0	MT	316/316L	TUBE-316-6MMOD X 1.0
1/4" OD x .035"	MT	316/316L	TUBE-316-1/4 OD X .035	6mm OD x 1.5	MT	316/316L	TUBE-316-6MMOD X 1.5
1/4" OD x .049"	MT	316/316L	TUBE-316-1/4 OD X .049	8mm OD x 1.0	MT	316/316L	TUBE-316-8MMOD X 1.0
1/4" OD x .065"	MT	316/316L	TUBE-316-1/4 OD X .065	8mm OD x 1.5	MT	316/316L	TUBE-316-8MMOD X 1.5
5/16" OD x 0.035"	MT	316/316L	TUBE-316-5/16 OD X .035	10mm OD x 1.0	MT	316/316L	TUBE-316-10MMOD X 1.0
5/16" OD x 0.049"	MT	316/316L	TUBE-316-5/16 OD X .049	10mm OD x 1.5	MT	316/316L	TUBE-316-10MMOD X 1.5
5/16" OD x 0.065	MT	316/316L	TUBE-316-5/16 OD X .065	10mm OD x 2.0	MT	316/316L	TUBE-316-10MMOD X 2.0
3/8" OD x .028"	MT	316/316L	TUBE-316-3/8 OD X .028	12mm OD x 1.0	MT	316/316L	TUBE-316-12MMOD X 1.0
3/8" OD x .035"	MT	316/316L	TUBE-316-3/8 OD X .035	12mm OD x 1.5	MT	316/316L	TUBE-316-12MMOD X 1.5
3/8" OD x .049"	MT	316/316L	TUBE-316-3/8 OD X .049	12mm OD x 2.0	MT	316/316L	TUBE-316-12MMOD X 2.0
3/8" OD x .065"	MT	316/316L	TUBE-316-3/8 OD X .065	16mm OD x 1.0	MT	316/316L	TUBE-316-16MMOD X 1.0
1/2" OD x .035"	MT	316/316L	TUBE-316-1/2 OD X .035	16mm OD x 1.5	MT	316/316L	TUBE-316-16MMOD X 1.5
1/2" OD x .049"	MT	316/316L	TUBE-316-1/2 OD X .049	16mm OD x 2.0	MT	316/316L	TUBE-316-16MMOD X 2.0
1/2" OD x .065"	MT	316/316L	TUBE-316-1/2 OD X .065	18mm OD x 1.0	MT	316/316L	TUBE-316-18MMOD X 1.0
1/2" OD x .083"	MT	316/316L	TUBE-316-1/2 OD X .083	18mm OD x 1.5	MT	316/316L	TUBE-316-18MMOD X 1.5
5/8" OD x 0.035"	MT	316/316L	TUBE-316-5/8 OD X .035	18mm OD x 2.0	MT	316/316L	TUBE-316-18MMOD X 2.0
5/8" OD x .049"	MT	316/316L	TUBE-316-5/8 OD X .049	20mm OD x 2.0	MT	316/316L	TUBE-316-20MMOD X 2.0
5/8" OD x .065"	MT	316/316L	TUBE-316-5/8 OD X .065	22mm OD x 2.0	MT	316/316L	TUBE-316-22MMOD X 2.0
5/8" OD x .083	MT	316/316L	TUBE-316-5/8 OD X .083	25mm OD x 2.0	MT	316/316L	TUBE-316-25MMOD X 2.0
5/8" OD x 0.095	MT	316/316L	TUBE-316-5/8 OD X .095	25mm OD x 2.5	MT	316/316L	TUBE-316-25MMOD X 2.5
5/8" OD x 0.120	MT	316/316L	TUBE-316-5/8 OD X .120	1/4" OD x 0.36"	MT	6Mo	TUBE-6MO-1/4 OD X 0.036
3/4" OD x 0.035	MT	316/316L	TUBE-316-3/4 OD X .035	1/2" OD x 0.49"	MT	6Mo	TUBE-6MO-1/2 OD X 0.049
3/4" OD x .049"	MT	316/316L	TUBE-316-3/4 OD X .049	1/2" OD x 0.65"	MT	6Mo	TUBE-6MO-1/2 OD X .065
3/4" OD x .065"	MT	316/316L	TUBE-316-3/4 OD X .065	3/8" OD x 0.49"	MT	6Mo	TUBE-6MO-3/8 OD X 0.049
3/4" OD x 0.083"	MT	316/316L	TUBE-316-3/4 OD X .083	3/8" OD x 0.65"	MT	6Mo	TUBE-6MO-3/8 OD X .065
3/4" OD x 0.095"	MT	316/316L	TUBE-316-3/4 OD X .095	1" OD x .125"	MT	6Mo	TUBE-6MO-1 OD X .125
3/4" OD x 0.109"	MT	316/316L	TUBE-316-3/4 OD X .109	6mm OD x 1.0	MT	6Mo	TUBE-6MO-6MMOD X 1.0
3/4" OD x 0.120"	MT	316/316L	TUBE-316-3/4 OD X .120	8mm OD x 1.0	MT	6Mo	TUBE-6MO-8MMOD X 1.0
7/8" OD x 0.049"	MT	316/316L	TUBE-316-7/8"OD X .049"	10mm OD x 1.0	MT	6Mo	TUBE-6MO-10MMOD X 1.0
7/8" OD x 0.065"	MT	316/316L	TUBE-316-7/8"OD X .065"	10mm OD x 1.5	MT	6Mo	TUBE-6MO-10MMOD X 1.5
7/8" OD x 0.083"	MT	316/316L	TUBE-316-7/8"OD X .083"	12mm OD x 1.5	MT	6Mo	TUBE-6MO-12MMOD X 1.5
7/8" OD x 0.109"	MT	316/316L	TUBE-316-7/8"OD X .109"	20mm OD x 2.0	MT	6Mo	TUBE-6MO-20MMOD X 2.0
1" OD x 0.035"	MT	316/316L	TUBE-316-1 OD X .035	25mm OD x 2.0	MT	6Mo	TUBE-6MO-25MMOD X 2.0
1" OD x 0.049"	MT	316/316L	TUBE-316-1 OD X .049	1/4" OD x 0.65"	MT	Monel 400	TUBE-M400-1/4 X .065
1" OD x 0.065	MT	316/316L	TUBE-316-1 OD X .065	1/2" OD x 0.48"	MT	Monel 400	TUBE-M400-1/2 OD X .048
1" OD x .083"	MT	316/316L	TUBE-316-1 OD X .083	1/2" OD x 0.83	MT	Monel 400	TUBE-M400-1/2 OD X .083
1" OD X 0.095"	MT	316/316L	TUBE-316-1 OD X .095	12mm x 1.5	MT	Monel 400	TUBE-M400-12MM X 1.5
1" OD X 0.109"	MT	316/316L	TUBE-316-1 OD X .109				

*Note: Non Std sizes are on an inquiry by inquiry basis

Training

The Right Tube + The Right Fitting + A Parker Trained Fitter = A High Integrity Solution

IPDE is pleased to announce the arrival and running of its new Small Bore Expert (SBEx) courses.

The course has been developed as an upgrade and replacement to our industry leading Safety at Work Programme, provide material that is relevant to your engineers on site.

Some of the advantages over our existing programme are:

- Greater knowledge of small bore tubing systems
- Increased product familiarity
- Increased skills and confidence in dealing with small bore systems

The benefits that your nominated trainer can pass on to your engineers are:

- Increased understanding of their own systems and installation practices
- Improvements in the safety and integrity of their small bore tubing systems
- Overall asset integrity improvement

What does the Trainer get?

- 5 days of training, including:
- A comprehensive kit including:
 - Spanners
 - Tube benders
 - Tube cutter
 - De-burrer
 - Vice grips
 - Fittings samples
 - Promotional clothing
 - License fee

This will be the only licensed and certified training course that we will allow to be run with our support.

What else do you get?

- Access to the only certified IPDE training course

Each individual fittings package incorporates summarized installation instructions which are adequate for most circumstances. However, it is strongly recommended that attention is given to the contents of the Parker Instrument Tube Fitting Installation Mini A-lok book and attendance to the Parker Certified Installer SBEx 'Small Bore Expert' Training is also highly beneficial and would be further recommended.



Our Materials Statement

Our primary philosophy is to build reliable, efficient, cost-effective equipment for the intended service. We always strive for the best quality in the designs we produce, the materials we select and manufacturing processes we apply. All our materials come from the most prestigious mills in Europe and North America, and are fully traceable to the source of origin and mercury and radioactive free. We want to add value to every component we create and make all the applications we serve **smarter, faster, cleaner and safer.**

Due to their versatility, reliability and excellent corrosion resistance, the set of alloys and equipment that we offer usually meet all the demands in markets, including the oil and gas, chemical and petrochemical processing, pollution control, marine engineering, power generation, or pulp and paper among others.

However, the unique requirements of some of the projects often demand special approaches. Parker Instrumentation understand those needs and has the technical knowledge and experience to help our customers to find the better solutions for their applications and meet even the most challenging demands.



Together, we can create innovative solutions that ensure your success

Gas Service

Special care must be taken when selecting tubing for gas service. In order to achieve a gas-tight seal, ferrules in instrument fittings must seal any surface imperfections.

This is accomplished by the ferrules penetrating the surface of the tubing. Penetration can only be achieved if the tubing provides radial resistance and if the tubing material is softer than the ferrules.

Thick walled tubing helps to provide resistance. Tables 1-14 (stainless to titanium pressure charts on pages 22 to 31) indicate the minimum acceptable wall thickness for various materials in gas service.

The ratings coloured in dark blue

indicate combinations of diameter and wall thickness which are not suitable for gas service.

Acceptable tubing hardness for general applications is listed in Tables 1-14. For most services, particularly in larger diameters and thicknesses, better results can be obtained by using tubing well below this maximum hardness.

For example, a desirable hardness of 80 HRB is suitable for stainless steel. The maximum allowed is 90 HRB.



Tubing Handling & Preparation

After tubing has been properly selected and ordered, careful handling is important.

From the receiving dock to point of installation, special attention is necessary to prevent scratching, burring and other injurious damage occurring to the tube.

This is especially important for gas service. Low-density gases such as helium and argon cannot be sealed with damaged tubing.

Make certain not to drag tubing across any surfaces such as truck beds, shelves, or storage racks, the floor and (or) ground of any plant/construction site. This is important for tubing of all materials. Besides scratching, improper handling can create out-of-round tubing.

Out-of-round tubing will not fit the I.D. of the ferrule(s) or the fitting body bore properly and will cause leakage.

Tube end preparation is also essential in assuring trouble-free systems. Some important points to consider are:

- Always Handling the Tubing carefully
- Cutting Tube End with either a tube cutter or hacksaw
- Deburring the tube end
- Cleaning the tube end

Tubing Ordering Suggestions:

Tubing for use with Parker instrument fittings must be carefully ordered to ensure adequate quality for good performance. Each purchase order must specify the material nominal outside diameter, and wall thickness. Ordering to ASTM specifications ensures that the tubing will be dimensionally, physically, and chemically within strict limits. Also, more stringent requirements may be added by the user. All tubing should be ordered free of scratches and suitable for bending and flaring.

Example:

A purchase order meeting the above criteria would read as follows:

“1/2 x 0.049 tubing in 316 stainless steel, seamless, as per ASTM A-269. Fully annealed, with hardness of 80 HRB or less. Must be suitable for bending and flaring; surface scratches, and imperfections are not permissible.”

Allowable Pressure Working Tables

System Pressure

The system operating pressure is another important factor in determining the type, and more importantly, the size of tubing to be used. In general, high pressure installations require stronger materials. Heavy walled softer tubing such as Alloy 625 permits the use of thinner tubes without reducing the ultimate rating of the system. In any event, tube fitting assemblies should never be pressurized beyond the recommended working pressure.

The following tables (1-14) list by material, the maximum suggested working pressure of various tubing sizes in combination with Parker A-LOK®/CPI™ fittings. Acceptable tubing diameters and wall thicknesses are those for which a rating is listed. Combinations, which do not have a pressure rating, are currently not recommended for use with instrument fittings. For higher pressures, see the Parker **Medium-Pressure Fittings or Phastite Fittings Range**.

Table 15 lists the de-rating factors which should be applied to the working pressures listed in Tables 1-14 for elevated temperature conditions. Simply locate the correct factor in Table 15 and multiply this by the appropriate value in Tables 1-14 for elevated temperature working pressure.

Temperature		Tubing Material						
°F	°C	Stainless 316/316L*	6Mo	Alloy 400	Alloy 625	Alloy 825	Alloy C276	Titanium Gr. 2
100	38	1	1	1	1	1	1	1
200	93	1	1	0.88	0.93	0.92	0.91	0.87
300	149	1	0.95	0.81	0.88	0.87	0.84	0.72
400	204	0.97	0.9	0.79	0.85	0.83	0.78	0.62
500	260	0.9	0.87	0.79	0.82	0.79	0.73	0.53
600	315	0.85	0.86	0.79	0.79	0.76	0.69	0.45
700	371	0.82	0.84	0.78	0.77	0.74	0.65	--
800	426	0.8	--	0.76	0.75	0.73	0.63	--
900	482	0.78	--	0.43	0.74	--	0.61	--
1000	537	0.77	--	--	0.73	--	0.6	--
1100	593	0.62	--	--	0.73	--	--	--
1200	649	0.37	--	--	0.72	--	--	--

* Dual-certified grades such as 316/316L, meet the minimum chemistry and the mechanical properties of both alloy grades.

Example:

Tubing Type 316 stainless steel seamless, 1/2 in. x 0.049 in. wall at 100 °F

- The allowable working pressure at room temperature (up to 100 °F) is 2800 psi (Refer to Table 1)
- The elevated temperature factor for 316 stainless steel is 0.77 at 1000 °F (Refer to Table 15)
- The allowable working pressure for 316 stainless steel tubing ½ in. x 0.049 in. wall at 1000 °F is then: 2800 psi x 0.77 = 2156 psi

The figures and tables included are for reference purposes only. Applicable codes and industry practices should be always considered when designing pressure systems.

- All working pressures have been calculated following the recommendations contained within ASME B31.3, Chemical Plant and Petroleum Refinery Piping Code, and ASME B31.1, Power Piping, and have been proven as accurate by extensive product testing. The calculation utilises an allowable stress figure that incorporates a 4:1 factor of safety.
- All calculations are based on maximum outside diameter and minimum wall thickness.
- All working pressures are applicable at ambient (72°F or 22°C) temperature.

NB.

All Parker A-LOK®/CPI™ tube fittings are designed such that successful assembly is achieved under most circumstances with 1 ¼ turns of the nut being applied from finger tight. For high pressure gaseous services or other critically severe service, consideration should be given to the utilization of a high pressure make up being 1 ½ turns of the nut from finger tight.

Certain combinations of tube and fitting may also benefit from other techniques to aid assembly such as utilization of a pre setting tool. Guidelines are given within the following tables and again we recommend attention to the Parker Instrument Tube Fitting Installation Manual and to the SBEX 'Small Bore Expert' training.

See page 15 for further details

Pipe Pressure Ratings

NPT / BSPT Pipe Size	BRASS			
	Male		Female	
	Straight ^a	Shape ^b	Straight ^a	Shape ^b
1/16	6000	5500	4500	3800
1/8	5600	5000	4000	2900
1/4	4100	4100	4300	3000
3/8	4000	4000	3500	2700
1/2	3900	3100	3600	2500
3/4	3800	3400	3000	2000
1	2700	2700	3100	2300
1-1/4	2000	2000	2300	1900
1-1/2	1800	1800	2100	1700
2	1600	1600	2000	1500

NPT / BSPT Pipe Size	CARBON STEEL			
	Male		Female	
	Straight ^a	Shape ^b	Straight ^a	Shape ^b
1/16	10500	10100	8000	7500
1/8	9700	9700	6800	5900
1/4	8000	8000	7000	6000
3/8	7600	7600	5600	5300
1/2	7000	6200	5500	4800
3/4	6800	6800	4600	3700
1	4900	4900	4800	4200
1-1/4	3700	3700	3700	3300
1-1/2	3100	3100	3400	2600
2	2800	2800	2800	2400

NPT / BSPT Pipe Size	STAINLESS STEEL			
	Male		Female	
	Straight ^a	Shape ^b	Straight ^a	Shape ^b
1/16	10000	9500	7500	7000
1/8	9100	9100	6400	5500
1/4	7500	7500	6600	5600
3/8	7200	7200	5300	5000
1/2	6600	5800	5200	4500
3/4	6400	6400	4300	3500
1	4600	4600	4500	3900
1-1/4	3500	3500	3500	3100
1-1/2	2900	2900	3200	2500
2	2600	2600	2700	2300

Notes:

- Fittings manufactured from bar stock.
- Fittings manufactured from forgings.
- Material of construction in accordance with Parker Catalog 4230/4233, Table 1.
- Pressure ratings for fittings with both tube and pipe ends are rated to the lower pressure.

Brass

Brass is a metal alloy of Copper and Zinc. Small additions of other alloying elements are added to modify the properties so that the resulting material is fit for a given purpose.

Brasses are medium strength engineering materials, comparable to high strength structural steels and some stainless steels and aluminium alloys. In the softened or annealed condition brasses are ductile and strong but when hardened by cold working their strength increases markedly. Brass has excellent machinability.

While brass may be less corrosion resistant than other copper alloys, its performance is quite adequate for many applications. However, brass tarnishes. Exposed to the atmosphere, it quickly forms a brown or gray-green protective corrosion film. Under certain conditions, brass can also dezincify. Dezincification is associated with submerged or stagnant exposure conditions, often in acidic media. Under atmospheric exposure, this form

of corrosion is usually limited to superficial attack.

Typical applications include:

- Valves, pumps, shafts, fittings, and fasteners.
- Heat Exchangers Tubes
- Automotive Industry
- Marine Engineering
- Piping

Refer to page 9 for product availability.

Typical Composition Grade 2	
Element	Weight (%)
Copper	60.0 to 63.0
Lead	2.5 to 3.7
Iron	0.35 max
Zinc	Remainder

Typical Specifications	
Product	Standard
Bar	ASTM B16
UNS No.	C36000



Carbon Steel

Carbon steel, also called plain carbon steel, is a malleable, iron-based metal containing carbon, small amounts of manganese, and other elements that are inherently present. It is the most widely used engineering material, and accounts for approximately 85% of the annual steel production worldwide.

Despite its relatively limited corrosion resistance, carbon steel is still used in large tonnages in numerous industrial applications.

Typical applications of Carbon Steel are:

- Pipeline Systems
- Mining
- Metal Processing Equipment
- Transportation
- Fossil Fuel Power Plants
- Petroleum Production & Refining

Refer to page 9 for product availability.

Typical Composition ASTM A105	
Element	Weight (%)
Carbon	0.35 max
Manganese	28.0 to 34.0
Copper	0.4 max
Nickel	0.4 max
Chromium	0.3 max
Molybdenum	0.12 max
Vanadium	0.08 max

Typical Composition ASTM A105 LF2	
Element	Weight (%)
Carbon	0.3 max
Manganese	0.6 to 1.35
Copper	0.4 max
Nickel	0.4 max
Chromium	0.3 max
Molybdenum	0.12 max
Columbium	0.02 max
Vanadium	0.08 max

Typical Specifications	
Product	Standard
Bar	ASTM A696
Forging	ASTM A105 ASTM A350 LF2
Other	NACE MR0175 NACE MR0103



Stainless Steel 316/316L

Stainless Steels 316/316L are austenitic grades and two of the most used alloys in a variety of industrial applications. The molybdenum addition gives this grade good resistance to general corrosion and provides increased strength at elevated temperatures. The austenitic structure also gives these grades excellent toughness, even at cryogenic temperatures. Grade 316L, the low carbon version of 316, minimizes harmful carbide precipitation due to welding.

It is common for 316 and 316L to be stocked in 'Dual Certified' form. These items have chemical and mechanical properties complying with both 316 and 316L specifications.

The corrosion resistance of stainless steel grades 316/316L is excellent in a wide range of atmospheric environments and many corrosive media. However,

it is subjected to pitting and crevice corrosion in warm chloride environments, as well as to stress corrosion cracking.

Initially developed for use in paper mills, 316/316L stainless steel is typically used in the following applications:

- Food processing equipment
- Brewery equipment
- Chemical and petrochemical equipment
- Laboratory equipment
- Boat fittings
- Chemical transportation containers
- Heat exchangers
- Nuts and bolts
- Springs
- Medical implants
- General Service Process Equipment

Typical Composition	
Element	Weight (%)
Carbon	0.03/0.08 max
Manganese	2.00 max
Chromium	16.0 to 18.0
Nickel	10.0 to 14.0
Molybdenum	2.0 to 3.0

Typical Specifications	
Product	Standard
Bar	ASTM A479
	ASTM A276
	EN 10088-3
Forging	ASTM A182
Casting	ASTM A351
Tube	ASTM A269
	ASTM A213
Other	NACE MR0175
	NACE MR0103
UNS No.	S31600/S31603

Refer to page 9 for product availability.



Tubing Specification: High Quality, Fully Annealed, Stainless Steel Tubing to ASTM A269 Grade 316/316L UNS S31600/S31603. Recommended Tube Hardness 80 HRB. Maximum Permissible Hardness 90 HRB.

Table 1		316/316L Stainless Steel														Imperial	
Tube O.D. Size	Wall Thickness, inches																
	0.010	0.012	0.014	0.016	0.020	0.028	0.035	0.049	0.065	0.083	0.095	0.109	0.120	0.134	0.156	0.188	
1/16	5600	6900	8200	9500	12100	16800											
1/8						8600	10900										
3/16						5500	7000	10300									
1/4						4000	5100	7500	10300								
5/16							4100	5900	8100								
3/8							3300	4800	6600								
1/2								2600	3700	5100	6700						
5/8									3000	4000	5200	6100					
3/4									2400	3300	4300	5000	5800				
7/8									2100	2800	3600	4200	4900				
1										2400	3200	3700	4200	4700			
1 1/4											2500	2900	3300	3700	4100	4900	
1 1/2												2400	2700	3000	3400	4000	4500
2													2000	2200	2500	2900	3200

Working pressure is measured in 'psig'

Table 2		316/316L Stainless Steel											Metric
Tube O.D. Size	Wall Thickness, mm												
	0.8	1.0	1.2	1.5	1.8	2.0	2.2	2.5	2.8	3.0	3.5	4.0	
3	720												
6	330	430	520	680									
8		310	380	490									
10		240	300	380	470								
12		200	240	310	380	430							
14		180	220	280	340	390	430						
15		170	200	260	320	360	400						
16			190	240	300	330	370	430					
18			170	210	260	290	330	380					
20			150	190	230	260	290	330	380				
22			140	170	210	230	260	300	340				
25					180	200	230	260	300	320			
28						180	200	230	260	280	330		
30						170	180	210	240	260	310		
32						160	170	200	220	240	290	330	

Working pressure is measured in 'bar'

- Not recommended for gas service
- Recommended for all services - standard assembly
- Recommended for all services - Use pre-assembly tool
- Recommended for all services - Use 'Hyferset' pre-assembly tool
- No data/Not recommended/No solution

Duplex Stainless Steel

Austenitic-Ferritic stainless steels, also called duplex stainless steels, were developed more than 70 years ago in Sweden for the paper industry in order to combat corrosion problems caused by chloride-bearing cooling waters and other aggressive chemical process fluids.

Due to the high content of chromium, nitrogen, and molybdenum, these steels offer good resistance to localised and uniform corrosion. The duplex microstructure contributes to the high mechanical strength, good abrasion, erosion and fatigue resistance. Duplex steels also possess good weldability properties.

Typical applications of duplex stainless steel are:

- Pulp and paper industry
- Components for structural design
- Storage tanks
- Cargo tanks and pipe systems in chemical tankers
- Water heaters
- Flue-gas cleaning
- Heat exchangers

Refer to page 9 for product availability.

Typical Composition	
Element	Weight (%)
Carbon	0.03 max
Manganese	2.00 max
Chromium	21.0 to 23.0
Nickel	4.5 to 6.5
Molybdenum	2.5 to 3.5
Nitrogen	0.08 to 0.02

Typical Specifications	
Product	Standard
Bar	ASTM A479 ASTM A276
Forging	ASTM A182 F51
Tube	ASTM A789
Other	NACE MR0175 NACE MR0103
UNS No.	S31803

Super Duplex Stainless Steel

First used in the 1980s, Super-Duplex refers to highly alloyed, high performance Duplex stainless steel with a improved pitting and crevice corrosion resistance.

Super duplex steels were designed for specific applications where both high mechanical strength and good corrosion resistance are required.

Super Duplex Stainless Steel is noted for its high level of chromium, which gives the alloy

excellent resistance to acid chlorides, acids, caustic solutions and other harsh environments.

Typical applications of super duplex stainless steel are:

- Desalination plants
- Heat exchangers
- Pollution control
- Pulp and Paper industry
- Tube & Pipe systems for petrochemical refineries
- Downhole

Typical Composition	
Element	Weight (%)
Carbon	0.03 max
Manganese	1.00 max
Chromium	24.0 to 26.0
Nickel	6.0 to 8.0
Molybdenum	3.0 to 4.0
Nitrogen	0.20 to 0.30
Copper	0.05 approx.

Typical Specifications	
Product	Standard
Bar	ASTM A479 ASTM A276
Forging	ASTM A182 F53/55
Tube	ASTM A789
Other	NACE MR0175 NACE MR0103
UNS No.	S32750/32760

Refer to page 9 for product availability.

Alloy 400

Alloy 400, also known as Monel™, is a nickel-copper alloy, resistant to sea water and steam at high temperatures as well as to salt and caustic solutions. The alloy possesses excellent corrosion resistance in a wide variety of media and is also characterized by good weldability and moderate to high strength.

The alloy has been used in a variety of applications. It has excellent resistance to rapidly flowing brackish water or seawater. It is particularly resistant to hydrochloric and hydrofluoric acids when they are de-aerated. Indeed, it is one of few metallic materials which can be used in contact with fluorine, hydrofluoric

acid, hydrogen fluoride and their derivatives.

The alloy is widely used in the chemical, oil and marine industries. Good mechanical properties from sub-zero temperatures up to 1020 °F.

Typical applications include:

- Valves, pumps, shafts, fittings, and fasteners, especially in marine environment
- Chemical and hydrocarbon processing equipment
- Crude oil distillation towers
- Gasoline and freshwater tanks
- Seawater Handling Equipment

Typical Composition Grade 2	
Element	Weight (%)
Nickel	63.0 min
Copper	28.0 to 34.0
Iron	2.5 max
Manganese	2.0 max
Carbon	0.3 max

Typical Specifications	
Product	Standard
Bar	ASTM B164
Forging	ASTM B564
Tube	ASTM B165
Other	NACE MR0175 NACE MR0103
UNS No.	N04400

Refer to page 9 for product availability.

Tubing Specification: High Quality, Fully Annealed, Alloy 400 Tubing to ASTM B165 Grade UNS N04400. Recommended Tube Hardness 70 HRB. Maximum Permissible Hardness 75 HRB.

Table 3 Alloy 400 Imperial								
Tube O.D. Size	Wall Thickness, inches							
	0.028	0.035	0.049	0.065	0.083	0.095	0.109	0.12
1/8	8000	10400						
1/4	3700	4800	7000	9800				
5/16		3700	5400	7500				
3/8		3100	4400	6100				
1/2		2400	3500	4700	6200			
3/4			2200	3000	4000	4600	5400	
1				2200	2900	3400	3900	4300

Working pressure is measured in 'psig'

- Not recommended for gas service
- Recommended for all services - standard assembly
- No data/Not recommended/No solution

Table 4 Alloy 400 Metric								
Tube O.D. Size	Wall Thickness, mm							
	0.8	1	1.2	1.5	2	2.5	2.8	3
3	670	890						
6	310	400	490	640				
8		290	350	460				
10		230	280	360				
12		190	230	290	400			
18			160	200	270			
20			140	180	240	310	350	
25				140	190	240	280	300

Working pressure is measured in 'bar'

Super Austenitic 6Mo

Super austenitic stainless steel 6Mo is a high performance alloy designed specifically for added corrosion resistance. It has the same structure as the common austenitic alloys, and greater levels of elements such as chromium, nickel, molybdenum, copper, and nitrogen, which gives it enhanced strength and corrosion resistance.

6Mo is especially suited for high-chloride environments such as brackish water, seawater, pulp mill bleach plants, and other high-chloride process streams. It is often used as a replacement in critical components where alloy 316/316L has failed by pitting, crevice attack, or chloride stress corrosion cracking. In many applications, the super austenitic stainless steels have been found to be a technically suitable and much more cost-effective alternative than nickel-base alloys.



Typical applications of this alloy are:

- Seawater Handling Equipment
- Pulp Mill Bleach Systems
- Tall Oil Distillation Columns and Equipment
- Chemical Processing Equipment
- Food Processing Equipment
- Desalination Equipment
- Flue Gas Desulfurization Scrubbers
- Oil and Gas Production Equipment

Why selecting Steel 6Mo grade over Steel 316 grade?

- For all those applications which involve moderate to high chloride presence.
- For those applications in which 316 has failed or is likely to fail due to pitting, crevice or induced stress corrosion cracking.
- For those applications that require compliance to NACE standards and the existing 316 range can not meet such demand.
- For NACE equipment in processes over 60 °C, where 316 is not permitted.

Parker Hannifin carried out Stress Corrosion Cracking Testing as per ASTM G48 conducted by an independent party that determined the time to failure of 6Mo to be 3 times higher of that of 316. In service applications, those results translate into a life expectancy of 6Mo three times longer than that of 316 in the same given conditions, reducing leakage and downtime and increasing safety by over 60%.

Why selecting Steel 6Mo grade over Super duplex grades?

- Choose 6Mo for improved corrosion resistance and super duplex for increased strength. The higher strength of super duplex grades can make this material more susceptible to stress corrosion cracking under certain conditions.
- For those applications that are likely to suffer from pitting corrosion. The pitting resistance given by the PREN or Pitting Resistance Equivalent Number is higher for 6Mo than for its super duplex counterparts.

6Mo is one of our best-seller materials. It has been successfully used in a wide range of applications in the North Sea, Middle East, Mexico Gulf or Australia. Typical applications cover offshore platforms, heat exchangers or desalination plants.

Typical Composition	
Element	Weight (%)
Carbon	0.02 max
Manganese	1.00 max
Chromium	19.5 to 20.5
Nickel	17.5 to 18.5
Molybdenum	6.0 to 6.5
Nitrogen	0.18 to 0.22
Copper	0.5 to 1.0

Typical Specifications	
Product	Standard
Bar	ASTM A479 ASTM A276
Forging	ASTM A182 F44
Tube	ASTM A269
Other	NACE MR0175 NACE MR0103
UNS No.	S31254

Refer to page 9 for product availability.

Tubing Specification: High Quality, Fully Annealed, Super Stainless Steel Tubing to ASTM A269/A213 Grade UNS S31254. Recommended Tube Hardness 80 HRB. Maximum Permissible Hardness 90 HRB.

Table 5		6Mo						Imperial
Tube O.D. Size	Wall Thickness, inches							
	0.02	0.028	0.035	0.049	0.065	0.083	0.095	
1/16								
1/8	7100	10500						
3/16		6700	8600					
1/4		4900	6300	10000	11000			
5/16			4900	7100				
3/8			4000	5800	8000			
1/2			3200	4600	6200			
5/8				3600	4900			
3/4				3000	4000	5200		
7/8				2500	3400	4400		
1					2900	3800	4400	

Working pressure is measured in 'psig'

- Not recommended for gas service
- Recommended for all services - standard assembly
- Recommended for all services - Use pre-assembly tool
- Recommended for all services - Use 'Hyferset' pre-assembly tool
- No data/Not recommended/No solution

Table 6		6Mo							Metric
Tube O.D. Size	Wall Thickness, mm								
	0.8	1	1.2	1.5	1.8	2	2.2	2.5	
3	550								
6	410	520	680						
8		380	470						
10		300	370	470					
12		250	300	380	470				
14			270	340	420				
15			250	320	390				
16			230	300	360				
18			210	260	320	360			
20			180	230	290	320			
22				210	260	290	320		
25					220	250	280	320	

Working pressure is measured in 'bar'

Alloy 825

Alloy 825 is a nickel-iron-chromium alloy with additions of molybdenum, copper, and titanium. The alloy is designed to provide exceptional resistance to many corrosive environments. Alloy 825 is resistant to corrosion in many acids and alkalis under both oxidising and reducing conditions, including sulphuric, sulphurous, phosphoric, nitric and organic acids, alkalis such as sodium or potassium hydroxide, and aqueous chloride solutions. High nickel content gives the alloy virtual immunity to stress corrosion cracking and good resistance to pitting and crevice.

Alloy 825 is a versatile general engineering alloy that exhibits good mechanical properties at both room and elevated temperatures (over 1000 °F).

Typical applications include:

- Chemical processing
- Pollution control
- Oil and gas recovery
- Acid production
- Nuclear fuel reprocessing

Typical Composition	
Element	Weight (%)
Carbon	0.05 max
Manganese	1.00 max
Chromium	19.5 to 23.5
Nickel	38.0 to 46.0
Molybdenum	2.5 to 3.5
Iron	22.0 min
Titanium	0.06 to 1.2
Aluminium	0.2 max
Copper	0.5 to 3.0

Typical Specifications	
Product	Standard
Bar	ASTM B425
Forging	ASTM B564
Tube	ASTM B423
Other	NACE MR0175 NACE MR0103
UNS No.	N08825

Refer to page 9 for product availability.



Tubing Specification: High Quality, Fully Annealed, Alloy 825 Tubing to ASTM B163 or B423 Grade UNS N08825. Recommended Tube Hardness 80 HRB. Maximum Permissible Hardness 90 HRB.

Table 7	Alloy 825			Imperial
	Wall Thickness, inches			
Tube O.D. Size	0.035	0.049	0.065	0.083
1/4	5400	8700	11100	
3/8	3500	5500	7600	
1/2	2700	4300	5900	

Working pressure is measured in 'psig'

Table 8	Alloy 825				Metric
	Wall Thickness, mm				
Tube O.D. Size	0.8	1	1.2	1.5	2
6	260	450	610	730	
10		260	350	440	
12		210	280	360	

Working pressure is measured in 'bar'

- Not recommended for gas service
- Recommended for all services - standard assembly
- Recommended for all services - Use pre-assembly tool
- No data/Not recommended/No solution

Alloy 625

This alloy has outstanding resistance to pitting and crevice corrosion as well as good resistance to intergranular attack. It also is almost totally resistant to chloride-induced stress corrosion cracking. With these properties the alloy has extremely high resistance to attack by a wide range of media and environments including nitric, phosphoric, sulphuric and hydrochloric acids, as well as alkalis and organic acids in both oxidising and reducing conditions. Alloy 625

has virtually no corrosive attack in marine and industrial atmospheres with extremely good resistance to seawater, even at elevated temperatures.

It is an excellent choice for applications that require high corrosion-fatigue strength or high tensile strength applications, creep and rupture strength and weldability.

Typical applications include:

- Sour Gas Service
- Engine exhaust systems
- Fuel and Hydraulic Lines
- Distillation columns and chemical transfer lines
- Nuclear water reactors

Alloy 625 is one of our best seller materials. It is one of the preferred alloy in a wide range of sour gas applications.



Typical Composition	
Element	Weight (%)
Carbon	0.1 max
Manganese	0.5 max
Chromium	20.0 to 23.0
Nickel	58.0 min
Molybdenum	8.0 to 10.0
Iron	5.0 max
Columbium + Tantalum	3.15 to 4.15
Titanium	0.4 max
Aluminium	0.4 max
Cobalt	1.0 max

Typical Specifications	
Product	Standard
Bar	ASTM B446
Forging	ASTM B564
Tube	ASTM B444
Other	NACE MR0175 NACE MR0103
UNS No.	N06625

Refer to page 9 for product availability.

Tubing Specification: High Quality, Fully Annealed, Alloy 625 Tubing to ASTM B444 Grade 2 UNS N06625. Recommended Tube Hardness 85 HRB. Maximum Permissible Hardness 93 HRB.

Table 9	Alloy 625		
	Wall Thickness, inches		
Tube O.D. Size	0.035	0.049	0.065
1/4	6800		
3/8	4400	6400	8700
1/2		5000	6800
3/4			4400

Working pressure is measured in 'psig'

- Recommended for all services - standard assembly
- Recommended for all services - Use pre-assembly tool
- Recommended for all services - Use 'Hyferset' pre-assembly tool
- No data/Not recommended/No solution

Table 10	Alloy 625				Metric
	Wall Thickness, mm				
Tube O.D. Size	0.8	1	1.2	1.5	1.8
6	440	570			
10	260	330	400	510	630
12			330	420	

Working pressure is measured in 'bar'

Alloy C276

Alloy C-276 is known for its excellent resistance to a wide variety of chemical process environments, including strong oxidizers such as ferric and cupric chlorides, hot contaminated media, chlorine, formic and acetic acids, acetic anhydride, and seawater and brine solutions. Alloy C-276 alloy has excellent resistance to pitting and to stress-corrosion cracking. It is also one of the few materials that withstands the corrosive effects of wet chlorine gas, hypochlorite, and chlorine dioxide. Alloy C-276 can resist the formation of grain boundary precipitates in the weld heat-affected zone, making it also a common candidate for most chemical and petrochemical

processing applications in the as-welded condition.

This alloy might be used in any environment that requires resistance to heat and corrosion but where the mechanical properties of the metal must be retained.

Typical applications include:

- Chemical processing
- Air Pollution control
- Pulp and Paper Production
- Marine Engineering
- Waste Treatment

Refer to page 9 for product availability.

Typical Composition	
Element	Weight (%)
Carbon	0.01 max
Manganese	1.00 max
Chromium	14.5 to 16.5
Nickel	51.0 min
Molybdenum	15.0 to 17.0
Iron	4.0 to 7.0
Tungsten	3.0 to 4.5
Cobalt	2.5 max
Vanadium	0.35 max

Typical Specifications	
Product	Standard
Bar	ASTM B574
Forging	ASTM B564
Tube	ASTM B622
Other	NACE MR0175 NACE MR0103
UNS No.	N10276

Tubing Specification: High Quality, Fully Annealed, Alloy C276 Tubing to ASTM B622 Grade UNS N10276. Recommended Tube Hardness 85 HRB. Maximum Permissible Hardness 93 HRB.

Table 11 Alloy C276 Imperial				
Tube O.D. Size	Wall Thickness, inches			
	0.028	0.035	0.049	0.065
1/4	5500			
3/8		4500	6500	8900
1/2		3500	5100	6900
5/8		2800		

Working pressure is measured in 'psig'

Table 12 Alloy C276 Metric				
Tube O.D. Size	Wall Thickness, mm			
	0.8	1	1.2	1.5
6	450	580		
10		330	410	520
12		270	330	430
15		230		

Working pressure is measured in 'bar'

- Not recommended for gas service
- Recommended for all services - standard assembly
- Recommended for all services - Use pre-assembly tool
- No data/Not recommended/No solution

Titanium Grade 2



Titanium is virtually immune to environmental attack. It withstands urban pollution, marine environments, the sulphur compounds of industrial areas and is failure-proof in even more aggressive environments. The uses for titanium in industry are growing faster than ever before as more and more engineers are discovering it can reduce lifecycle costs across a broad range of equipment and processes. Titanium has an exceptionally high strength to weight ratio, allowing for lighter components or reduced wall thicknesses. Any remaining higher up front costs are almost always recouped in multiple due to increased production time and reduced maintenance. Titanium forms a very tenacious surface oxide layer, which is an

outstanding corrosion inhibitor. In many harsh environments it can outlast competing materials as much as 5 times longer. Lower failure rates translate to less downtime, reduced maintenance and total lower cost.

Typical applications include:

- Chemical processing
- Power Generation
- Aerospace and Defence
- Petrochemical Refineries
- Desalination Plants

Typical Composition Grade 2	
Element	Weight (%)
Nitrogen	0.03 max
Carbon	0.08 max
Hydrogen	0.015 max
Iron	0.3 max
Oxygen	0.25 max
Titanium	Remainder

Typical Composition Grade 5	
Element	Weight (%)
Nitrogen	0.05 max
Carbon	0.08 max
Hydrogen	0.015 max
Iron	0.4 max
Oxygen	0.2 max
Aluminium	5.5 to 6.75
Vanadium	3.5 to 4.5
Titanium	Remainder

Typical Specifications	
Product	Standard
Bar	ASTM B348
Plate	ASTM B265
Forging	ASTM B381
Tube	ASTM B338
Other	NACE MR0175
UNS No.	R50400/56400

Refer to page 9 for product availability.

Tubing Specification: High Quality, Fully Annealed, Titanium Tubing to ASTM B338 Grade 2 UNS R50400. Recommended Tube Hardness 75 HRB. Maximum Permissible Hardness 85 HRB.

Tube O.D. Size	Wall Thickness, inches			
	0.028	0.035	0.049	0.065
1/4	3300	4200	6200	
3/8		2700	4000	5400
1/2		2100	3100	

Tube O.D. Size	Wall Thickness, mm			
	0.8	1	1.2	1.5
6	280	350	440	
10		200	250	320
12		170	200	

Working pressure is measured in 'psig'

Working pressure is measured in 'bar'

- Not recommended for gas service
- Recommended for all services - standard assembly
- Recommended for all services - Use pre-assembly tool
- No data/Not recommended/No solution

Suparcase™ for A-LOK® Back Ferrules

The first step in ensuring the integrity of any system is to choose the right materials for the job. That's why Parker supply fittings in a wide range of exotic materials for applications where corrosion is an issue, and where new, harder materials for tubing for high-integrity applications are being used.

The Suparcase™ PRINCIPLE

The Parker Suparcase™ surface treatment is a unique process that allows stainless steels and other alloys to be hardened without affecting, and even increasing, the corrosion resistance of the given materials. Parker has been using the proprietary Suparcase process to surface harden stainless steel ferrules for approximately 20 years. The process achieves a carbon supersaturated surface layer by altering the oxide passive layer on the surface of the stainless steel, without any detrimental effects.

Good Tube Grip = Harder Rear Ferrule = Smarter, Faster, Cleaner, Safer

- Suparcase™ process perfected by Parker gives the Differential Hardness
- Some competitor hardening process corrode (i.e. Nitride or Edge Hardening)
- Suparcase™ increases the corrosion resistance
- Suparcase™ is applied to all back ferrules, all sizes

A-LOK® body. Includes precision machined threads and burnished cones for enhanced sealing. Materials sourced only in Western Europe to ensure quality capable of performing in the most harsh process environments. Includes material & HCT identification.

A-LOK® front ferrule. Precision machined to seal every time. Includes material identification.

A-LOK® nut with silver plated threads for lubrication. Outer shoulder is roll-marked with the Parker name, size and material identification.

A-LOK® precision machined back ferrule. Parker were the first to Suparcase™ harden the back ferrule and lead the world for outstanding corrosion resistance and superior grip. Includes material identification.

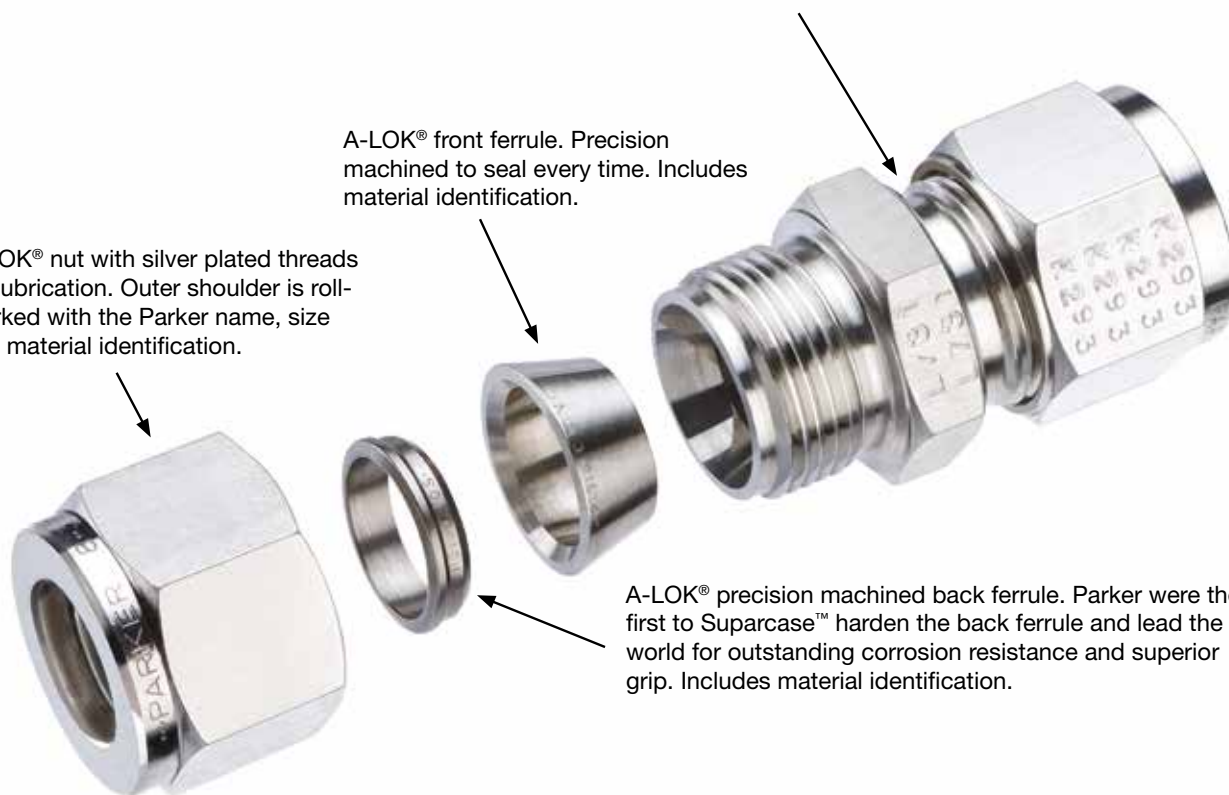

Suparcase™ Advantages

The result is a thin surface region supersaturated with carbon in solid solution. This surface region has some unusual advantageous properties:

- **Improved Hardness**
Hardness Test – Suparcased samples are at least 250% harder than their untreated counterparts.
- **Increased Fatigue Strength**
Bending Test – Suparcased samples showed 50% increase in fatigue strength with respect to the same untreated samples under the same number of cycles.
- **No change in shape, size or colour**
- **Suparcase Layer does not crack or delaminate during forming**

- **Outstanding Wear and Erosion Resistance**

Wear Test performed on a high pressure homogenizer made out of Stainless Steel 316 – The Suparcase™ samples increased the wear & erosion resistance by 13 times in air and by 10 times in seawater with respect to their untreated counterparts.

- **Exceptional Corrosion Resistance**

ASTM G48 - Standard Test Methods for Pitting and Crevice Corrosion Resistance of Stainless Steels and Related Alloys by Use of Ferric Chloride Solution. Test Results on Type 316 Suparcased™ stainless steel:

Condition	ASTM G 48 Ferric Chloride Test Results
As-machined (Cold Worked)	6.1% weight loss
As-machined + Suparcase™	0.0% weight loss
Annealed + Suparcase™	No corrosion



Suparcased Rear Ferrule



Nitride hardened Rear Ferrule

ASTM G150 Critical Pitting Temperature. CPT measures the temperature at which pitting is likely to start:

Alloy	UNS Number	CPT Range - °C
316	S31600	0 - 30
317L	S31703	32 - 45
904L	N08904	30 - 55
316 Suparcase™	S31600	69 - 75
6Mo	S31254	70 - 90

CPI™/A-LOK® Tube Fittings

Visual Index

Single/Double Ferrule
Instrument Compression
Fittings

Tube to Male Pipe

Male Connector

FBZ, MSC
pages 41-45



Male Bulkhead Connector

FH2BZ, MBC
page 46



Thermocouple Connector

FH4BZ, MTC
page 47



Male Elbow

CBZ, MSEL
pages 47-49



NPT Male 45° Elbow

VBZ, MVEL
page 50

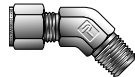

NPT Male Run Tee

RBZ, MRT
page 51

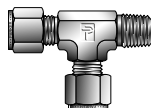

NPT Male Branch Tee

SBZ, MBT
page 52

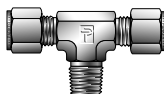

Tube to Female Pipe

Female Connector

GBZ, FSC
pages 53, 54



Female Bulkhead Connector

GH2BZ, FBC
page 55



Gauge Connector

GBZ, FSC
pages 55, 56



Female Elbow

DBZ, FEL
page 56

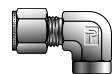

Female Run Tee

MBZ, FRT
page 57

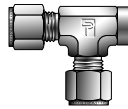

Female Branch Tee

OBZ, FBT
page 58



Tube to Tube Unions

Union

HBZ, SC
page 59



Conversion Union

HBZ, CU
page 60

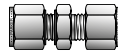

Reducing Union

HBZ, RU
page 60



Bulkhead Union

WBZ, BC
page 61



Dielectric Union Adapter, Dielectric Assembly

DEBTADELTA
page 62



Union Elbow

EBZ, EE, ELZ
pages 62, 63

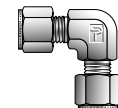

Union Tee

JBZ, ET
page 64

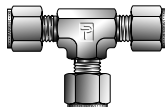

Drop Size Tee

JBZ, JLZ
page 65

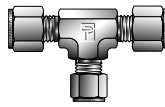

Union Cross

KBZ, ECR
page 66

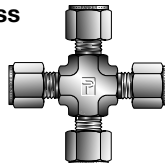

Port Connectors

Tube End Reducer

TRBZ, TUR,
TUC
pages 67-69



Tube End Bulkhead Adapter

T2H2BZ,
TUBC
page 70



Port Connector

ZPC, PC
page 70



Tube End Male Adapter

T2HF, MA
pages 71-74



Tube End to SAE Straight Thread Adapter

T2HOA, TUOHA
page 75



Tube End Female Adapter

T2HG, FA
pages 75-77



Push-Lok to Tube Adapter

P2T2, P2TU
page 77



Push-Lok to Male Adapter

P2HF
page 78



Push-Lok to CPI™/A-LOK®

P2BZ6, P2LZ6
page 78



Push-Lok to Port Connector

ZPB2, ZPC2
page 78

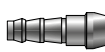

Lapped Joint Tube Adapters

LJFBZ, LJF
page 79



DP Transmitter Calibration Adapters

ZH2LX
page 79

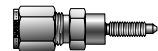

37° Flare (AN) to CPI™/A-LOK®

37° Flare (AN) to CPI™/A-LOK®

X6HBZ6, X6TU
page 80



37° Flare Connector to CPI™/A-LOK®

XHBZ, XASC
page 80

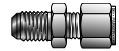

37° Flare Bulkhead Connector to CPI™/A-LOK®

XH2BZ,
XABC
page 80



Tube to O-Ring Seal

Male Connector SAE Straight Thread

ZHBA, M1SC
page 82



Male SAE Straight Thread Elbow

C5BZ, M5SEL
page 83



Male BSPP Straight Thread Elbow

CBZ, MSEL
page 83

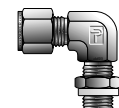

Male Run Tee SAE Straight Thread

R5BZ,
M5RT
page 84

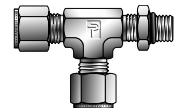



Male BSPP Run Tee Straight Thread

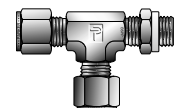

RBZ, MRT
page 84

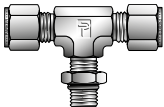
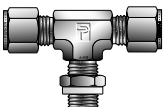
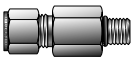
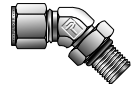
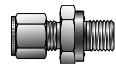
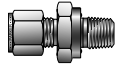
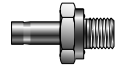
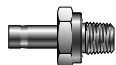

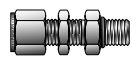



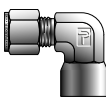
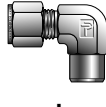

Visual Index



- Male Branch Tee SAE Straight Thread**
S5BZ, M5BT
page 85 
- Male BSPP Branch Tee Straight Thread**
SBZ, MBT
page 85 
- Long Male Connector SAE Straight Thread**
ZH3BA, ZH3LA
page 86 
- 45° Positionable Male Elbow**
V5BZ, M5VEL
page 86 
- Male Connector to O-Ring Straight Thread**
ZHBA5, M2SC
page 87 
- Male Connector to O-Ring Pipe Thread**
ZHBF5, M3SC
page 87 
- Tube End to O-Ring Straight Thread**
T2HOA5, M2TU
page 88 
- Tube End to O-Ring Pipe Thread**
T2HOF5, M3TU
page 88 
- Pipe Thread to SAE Straight Thread Adapter**
FHOA
page 89 
- Bulkhead to Conversion Adapter**
AH2BZ, AH2LZ
page 89 

Tube to Welded Systems

- Socket Weld Elbow**
ZEBW, ZELW
page 91 
- Buttweld Elbow**
ZEBW2, ZELW2
page 91 
- Socket Weld Connector**
ZHBW, ZHLW
page 92 
- Buttweld Connector**
ZHBW2, ZHLW2
page 92-93 

Analytical Fittings

- Column End Fitting – Low Internal Volume with Frit**
Z2HCZ7, Z2HLZ7
page 95 
- Column End Fitting – Low Internal Volume**
Z3HCZ7, Z3HLZ7
page 95 
- Column End Fitting – Low Internal Volume (without Frit)**
ZHCZ7, ZHLZ7
page 96 
- Column End Fitting – with Frit**
Z2HCZ, Z2HLZ
page 96 
- Column End Fitting (without Frit)**
ZHCZ, ZHLZ
page 97 
- Union Connector – Low Dead Volume**
Z7HBZ7, Z7HLZ7
page 97 





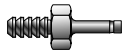

- Male Connector – Low Dead Volume**
FBZ7, FLZ7
page 98 
- Sanitary Flange Fitting**
ZHBS, ZHLS
page 98 







Barbed Fittings

- Barbed Connector to Male Pipe**
B2HF
page 99 
- Barbed Connector to Tube Adapter**
B2HT2, B2TU
page 99 

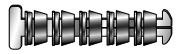
- Hose Connector Sleeve**
HCS
page 99 

Components

- Insert**
TIZ
page 100 
- Tube Nut**
BZ, NU
page 100-101 
- Inverted Tube Nut**
BZI
page 101 
- Knurled Nut**
BZP
page 101 
- Ferrules**
TZ
page 101 
- Front Ferrules**
FF
page 102 
- Back Ferrules**
BF
page 102 

- Ferrule Holder**
page 102 
- Plug**
FNZ, BLP
page 103 
- Cap**
PNBZ, BLEN
page 103-104 
- Vent Protector**
MDF
page 104 
- Sealing Washers Bonded Seal and Copper**
page 105 
- Bulkhead Locknut**
WLZ, WLN, BN
page 106 
- Accessory Locknut**
L5NR
page 106 

Reference Material

- Assembly and Remake Instructions**
page 107
- Gaugeability Instructions**
page 107

CPI™/A-LOK® Tube Fittings

Introduction

Parker CPI™/A-LOK® Instrumentation Tube Fittings are designed as leak-free connections for process, power and instrumentation applications. These single and two ferrule fittings are manufactured to the highest quality standards and are available in a broad range of sizes, materials and configurations.

Features

The Parker CPI™/A-LOK® tube fitting has been specifically designed for use on instrumentation, process and control systems, analysers and environmental equipment employed in chemical, petroleum, power generating and pulp and paper plants. CPI™/A-LOK® fittings have also been used extensively in other applications and industries wherever high reliability and quality are required.

Materials

Parker CPI™/A-LOK® fittings are available as standard in Heat Code Traceable, 316 stainless steel. Other materials include steel, brass, aluminum, nickel-copper, Hastelloy C®, Alloy 600, Titanium, 6Mo, Incoloy 625 and 825. Straight fittings are machined from cold finished bar stock and shaped bodies are machined from close grain forgings. The raw materials used fully conform to the chemical requirements listed in Specification Table 1 found on page 38. For nuclear and other critical applications, stainless steel CPI™/A-LOK® fittings are readily available with documented heat code traceability.

Pipe Fittings/Adapters

Parker CPI™/A-LOK® tube fittings are available in combination with a variety of ISO and ANSI pipe thread configurations. For a full listing of these fittings, see pages 108-133.

Tubing

Parker CPI™/A-LOK® tube fittings can be used with a wide variety of tubing materials and a broad range of tube wall thicknesses. CPI™/A-LOK® seals equally well on both thin wall and heavy wall tubing. Tubing and fitting materials should be selected to be compatible with the fluid media. Due to thermal expansion characteristics and chemical stability, the tubing should be of the same material as the fitting. (The exception is brass fittings and copper tubing.)

Torque

Parker CPI™/A-LOK® tube fittings do not twist the tubing during installation. CPI™/A-LOK® ferrule designs assure that all make and remake motion is transmitted axially to the tubing. Since no radial movement of the tubing occurs, the tubing is not stressed. The mechanical integrity of the tubing is maintained.

No Distortion

In make-up, there is no undue force in an outward direction to distort the fitting body or ferrules to cause interference between the ferrules and nut. This assures that the nut will back-off freely for disassembly and permits a greater number of easy remakes.

Sealing

Positive, reliable connections with Parker CPI™/A-LOK® fittings have been qualified by exhaustive tests and over four decades of experience in the manufacture of quality tube fittings.

Nomenclature

Parker CPI™/A-LOK® fitting part numbers are constructed from symbols that identify the size and style of the fitting and material used.

Assembly, Remake, Gaugeability

Proper assembly is the key component to a leak-free system. CPI™/A-LOK® tube fitting assembly, remake and gaugeability instructions are found on page 107 of this catalog.

Pressure Rating & Tubing Selection

For working pressures of CPI™/A-LOK® tube connections, please see pages 20–23 of this catalog, the Instrument Tubing Selection Guide (4200-TS) found in the Technical Section of your Parker Instrumentation Products Process Binder, or the Parker Instrument Tube Fitting Installation Manual (Bulletin 4200-B4).

In cases where a male or female pipe thread is the second end of a Parker CPI™/A-LOK® fitting, such threads may be the pressure limiting factor of the tubing system. Pressure ratings for Pipe Ends are shown on page 19.

CPI™ / A-LOK® Tube Fittings

Parker CPI™ / A-LOK® fittings consists of precision engineered parts designed to provide secure leak-proof joints capable of satisfying high pressure, vacuum and vibration applications.

Inch – CPI™

The Parker Supracase® ferrule provides a strong mechanical and anti-vibration hold on the tube

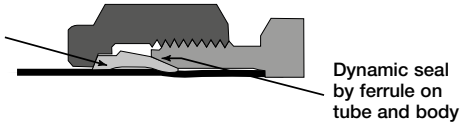

Dynamic seal by ferrule on tube and body

Molybdenum disulfide coated nut with fine pitch threads ensure no galling

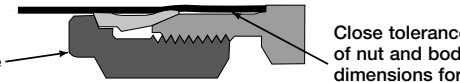

Close tolerance of nut and body dimensions for accurate tube alignment

Inch – A-LOK®

The Parker Supracase® back ferrule provides a strong mechanical and anti-vibration hold on the tube.

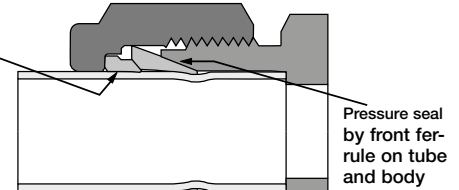

Pressure seal by front ferrule on tube and body

Parker's high quality, silver plated nut ensures no galling of body threads

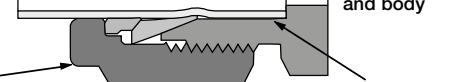

Deep tube abutment and close tolerance of nut and body for accurate tube alignment

Metric – CPI™

The Parker Supracase® ferrule provides a strong mechanical and anti-vibration hold on the tube



Metric identification shoulder

Dynamic seal by ferrule on tube and body

Molybdenum disulfide coated nut with fine pitch threads ensure no galling

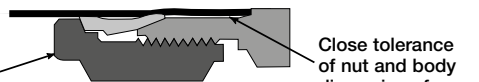

Close tolerance of nut and body dimensions for accurate tube alignment

Metric – A-LOK®

The Parker Supracase® back ferrule provides a strong mechanical and anti-vibration hold on the tube.

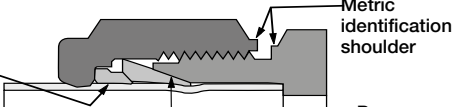

Metric identification shoulder

Pressure seal by front ferrule on tube and body

Parker's high quality, silver plated nut ensures no galling of body threads



Deep tube abutment and close tolerance of nut and body for accurate tube alignment

Parker Instrumentation Tube Fittings are supplied complete and ready to use. The ferrule(s) swage onto the tube as it moves down the body seat creating a pressure/vacuum-tight seal on both tube and body by the interface pressure and surface finish of mating components. The Parker Supracase™ ferrule (back-ferrule only on A-LOK®) creates a strong mechanical hold on the tube.

CPI™ / A-LOK® Tube Fittings

Table 1 – Typical Raw Material Specifications

BASIC FITTING MATERIAL	MATERIAL DESIGNATOR	BAR STOCK	FORGING	COMMON TUBING SPECIFICATION
Brass	B	CA-360 QQ-B 626 Alloy 360 ASTM-B16 Alloy 360 CA-345 ASTM-B-453 Alloy 345	CA-377 QQ-B 626 Alloy 377 ASTM-B-124 Alloy 377 BS2872 CZ122	ASTM-B75 ASME-SB75 (TEMPER "O")
Stainless Steel (Type 316) ⁽¹⁾	A-LOK® = 316 ⁽¹⁾⁽²⁾ CPI™ = SS	ASME-SA-479 Type 316-SS BS970 316-S31 DIN 4401 ASTM A276 Type 316	ASME-SA-182 316 BS970 316-S31 DIN 4401	ASME-SA-213 ASTM-A-213 ASTM-A-249 ASTM-A-269 ⁽³⁾ MIL T-8504 MIL T-8506
Steel	S	ASTM-A-108 QQ-S-637	ASTM-A-576	SAE J524b SAE J525b ASTM-A-179
Aluminum	A	2017-T4 or 2024-T4 ASTM-B211 QQ-A-225/5 or 6	2014T (as fabricated) ASTM-B-211 QQ-A-225/4	303, 6061T6 ASTM-B-210
Monel® 400 – Forgings Monel® 405 – Bar Stock	M	ASTM-B-164 QQ-N-281 BS3076 NA13	ASTM-B-164 QQ-N-281 BS3076 NA13	ASTM-B-165
Hastelloy® C-276	NNR	ASTM-B-574 ASTMB575	ASTM-B-574	ASTM-B-622 ASTM-B-626
Inconel® Alloy 600	IN	ASTM B-166 ASME-SB-166	ASTM-B-564	ASTM-B-163
Carpenter® 20	SS20	ASTM-B-473	ASTM-B-462 ASTM-B-472	ASTM-B-468
Titanium	T	ASTM-B-348	ASTM-B-381	ASTM-B-338
Inconel® Alloy 625	625	BS3076 NA16 ASTMB425	BS3076 NA16 ASTMB425	ASTM-B-625 ASTM-B-444 ASTM-B-423 ASTM-B-829
Incoloy® Alloy 825	825			
6MO	6MO	UNS S31254 UNS N08367 ASTM A479	UNS S31254 UNS N08367 ASTM A 479	ASTM-A-269

(1) If more specific information, including heat code traceability, is required, your Parker Hannifin CPI™ / A-LOK® distributor will provide details.

(2) If an "L" appears in the A-LOK® fitting description, then the material designator will be "SS" (e.g., JLZ drop size tee).

(3) Stainless steel CPI™ / A-LOK® tube fittings work reliably on both seamless and welded-redrawn, fully annealed type 304, 316 and 316L tubing.

NOTE: Hastelloy® is a registered trademark of Haynes International. Inconel®, Incoloy® and Monel® are registered trademarks of Special Metals Corporation. Carpenter® is a registered trademark of CRS Holdings Inc.

Tube End Dimensional Data

SIZE NO.	INCHES					
	TUBE O.D.	STRAIGHT THREAD	†C	H HEX	E DIA.	†D TUBE INS. DEPTH
1	1/16	10-32	.43	5/16	.052	.34
2	1/8	5/16-20	.60	7/16	.093	.50
3	3/16	3/8-20	.64	1/2	.125	.54
4	1/4	7/16-20	.70	9/16	.187	.60
5	5/16	1/2-20	.73	5/8	.250	.64
6	3/8	9/16-20	.76	11/16	.281	.67
8	1/2	3/4-20	.87	7/8	.406	.90
10	5/8	7/8-20	.87	1	.500	.96
12	3/4	1-20	.87	1-1/8	.625	.96
14	7/8	1-1/8-20	.87	1-1/4	.750	1.03
16	1	1-5/16-20	1.05	1-1/2	.875	1.24
20	1-1/4	1-5/8-20	1.52	1-7/8	1.09	1.61
24	1-1/2	1-15/16-20	1.77	2-1/4	1.34	1.96
32	2	2-5/8-20	2.47	2-3/4	1.81	2.65

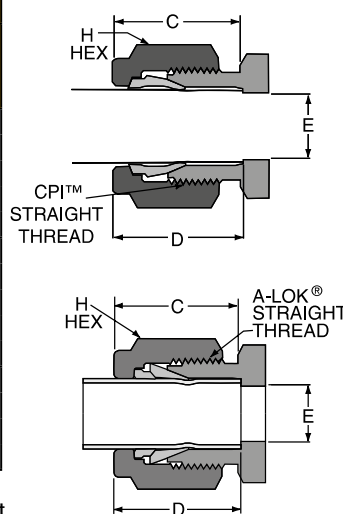

SIZE NO.	MILLIMETERS					
	TUBE O.D.	STRAIGHT THREAD	†C	H HEX	E DIA.	†D TUBE INS. DEPTH
2	2mm	5/16-20	15,3	12,0	1,7	12,9
3	3mm	5/16-20	15,3	12,0	2,4	12,9
4	4mm	3/8-20	16,1	12,0	2,4	13,7
6	6mm	7/16-20	17,7	14,0	4,8	15,3
8	8mm	1/2-20	18,6	15,0	6,4	16,2
10	10mm	5/8-20	19,5	18,0	7,9	17,2
12	12mm	3/4-20	22,0	22,0	9,5	22,8
14	14mm	7/8-20	22,0	24,0	11,1	24,4
15	15mm	7/8-20	22,0	24,0	11,9	24,4
16	16mm	7/8-20	22,0	24,0	12,7	24,4
18	18mm	1-20	22,0	27,0	15,1	24,4
20	20mm	1-1/8-20	22,0	30,0	15,9	26,0
22	22mm	1-1/8-20	22,0	30,0	18,3	26,0
25	25mm	1-5/16-20	26,5	35,0	21,8	31,3
28	28 mm	M37	35,7	46,0	21,8	35,6
30	30 mm	M40	38,5	50,0	26,2	38,8
32	32 mm	M42	41,3	50,0	28,6	41,6

NOTE: Dimensions C and D are shown in the finger-tight position.

† Average Value

Dimensions for reference only, subject to change.

NOTE: Dimensions C and D are shown in the finger-tight position.

† Average Value

CPI™ /A-LOK® Tube Fittings

Nomenclature/How to Order

Parker CPI™/A-LOK® tube fitting part numbers are constructed using alphanumeric characters to identify the size, style and material of the fitting.

Single/Double Ferrule Instrument Compression Fittings

CPI™ Inch Parts

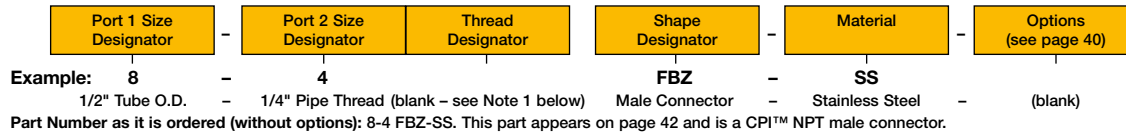

A-LOK® Inch Parts

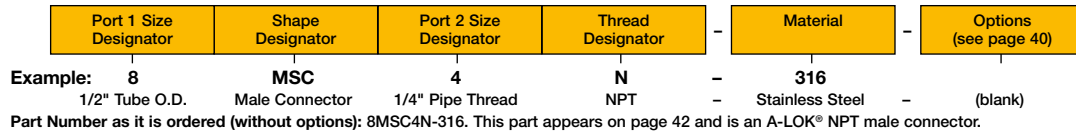

CPI™ Metric Parts

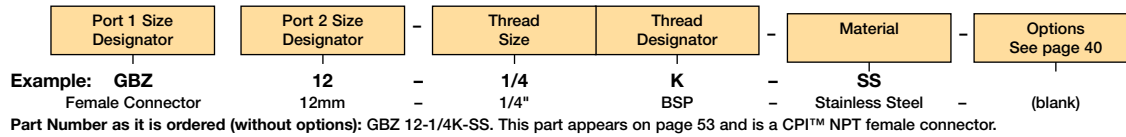

A-LOK® Metric Parts

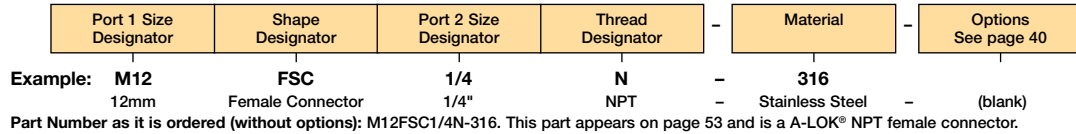

Body Designator: A letter or combination of letters and numbers are used to designate the type of fitting. See the visual index on pages 36 and 37 for body designator.

Fractional Size: Tube and pipe thread sizes are designed by the number of sixteenths of an inch (1/2" tube = 8/16" = 8) (1/4" pipe thread = 4/16" = 4).

Metric Size: Metric tube is designated in millimeters and prefixed "M" (i.e., 12mm tube – M12.) The pipe thread size is written as a fraction (i.e., 1/4 NPT = 1/4).

All Straights & Elbows: Call out largest CPI™/A-LOK® tube end size first followed by the smaller CPI™/A-LOK® tube end or pipe thread size.

Fractional Tees & Crosses: For drop size tees – first size the run (1 to 2) and then branch (3). Example – the size designator for a male run tee for 3/8" O.D. tube and 1/4" male pipe thread would be 6-4-6. For crosses – first size the run (1 to 2) and then the branch (3 to 4). For tees with all ends the same, use the tube and size before and after the style designator; i.e. 4-4-4 JBZ (CPI™), 4ET4 (A-LOK®).

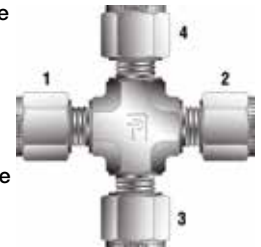

Metric Tees & Crosses: For drop size tees – first size the run (1 to 2) and then branch (3). Example – the size designator for a male run tee for 6mm tube and 1/4" male pipe thread would be 6-4-6. For crosses – first size the run (1 to 2) and then the branch (3 to 4). For tees with all ends the same, use the tube end size after the style designator; i.e. JBZ 4-4-4 JBZ (CPI™), ETM4 (A-LOK®).

Material: See Table 1 on the previous page for the material symbol.

Thread Types:

N = NPT ⁽¹⁾ /National Pipe Taper	ANSI B1.20.1
K = BSP/ISO Taper	BS21, ISO7/1
R = BSP/ISO Parallel	BS2779, ISO 228/1+2, DIN 3852 FORM A ⁽²⁾
BR = BSP/ISO Parallel	BS2779, ISO 228/1+2, DIN 3852 FORM B ⁽³⁾
M = Metric Thread	ISO 6149-2
R-ED = BSPP/ISO Parallel	BS2779, ISO 228/1+2, DIN 3852 with elastic sealing washer ⁽⁴⁾
GC = BSPP Gauge Connector	B2779, ISO 228/1+2, DIN 3852

- (1) N thread designator is only used for A-LOK® nomenclature.
- (2) Form A requires the use of a bonded washer. See page 105 of this catalog.
- (3) Form B (cutting face) may be used with or without a sealing washer.
- (4) ED fittings are supplied with Nitrile sealing washers as standard. Fluorocarbon seals are available upon request.

Special Fittings: Consult the factory. If there is any question as to the fitting desired, particularly for special fitting configurations, it is suggested that a customer print be submitted.

Special Options: See the following page for available options.

CPI™ / A-LOK® Tube Fittings

CPI™ / A-LOK® Options

Parker CPI™/A-LOK® fittings may be ordered with the following options.

How to order

After the complete CPI™/A-LOK® number simply add a "dash" then the suffix for the option.

The following example is an A-LOK® male connector for 1/2" OD tube and 1/4" male pipe that has been cleaned for oxygen service. For additional options, please consult the factory.

8MSC4N-316-C

Suffix	Option	Additional Information
ZYF	Assembled with nylon ferrule(s)	
SPF	Silver plated ferrule(s)	
TF	PTFE ferrule(s)	
BP*	Bulk packed	* Indicates the quantity i.e BP50 for a fifty count package.
LWH	Lock wire hole	
BZP	Knurled nut	Replaces standard nut on CPI™/A-LOK® fittings for use on soft plastic tubing.
C	Silver plated nut	Replaces moly coated nut (BZ).
MI	Moly inside nut	
CNQ	Certified Nuclear Quality	
C1	Grade A Cleaning	Special cleaning, assembly, inspection and packaging for high purity applications.
C3	Cleaned for oxygen service	Meets the requirements of ASTM G93-88; Standard Practice for Cleaning Methods for Materials and Equipment used in Oxygen-Enriched Environments.
CNG	Compressed natural gas service	Assembled with a specific o-ring compound.
NIC	Nickel plated	
CRM	Chrome plated	
VO	Viton O-ring	
NC**	NACE Compliant material	See page 7 for details
DFARS	Defense Acquisition Regulations System	All components and raw material must be of US origin or from an approved country.

**Manufactured from materials that meet the metallurgical requirements of NACE MR0175 2003

Tube to Male Pipe

NPT Male Connector For fractional tube

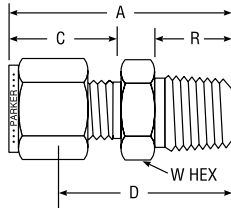
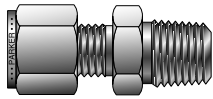

CPIT™ PART NO.	A-LOK® PART NO.	INTER-CHANGES WITH	INCHES						
			TUBE O.D.	NPT PIPE THREAD	A	C	D	R	W HEX
1-1 FBZ	1MSC1N	100-1-1	1/16	1/16	.93	.43	.78	.38	5/16
1-2 FBZ	1MSC2N	100-1-2	1/16	1/8	1.03	.43	.88	.38	7/16
1-4 FBZ	1MSC4N	100-1-4	1/16	1/4	1.23	.43	1.08	.56	9/16
2-1 FBZ	2MSC1N	200-1-1	1/8	1/16	1.17	.60	.91	.38	3/8
2-2 FBZ	2MSC2N	200-1-2	1/8	1/8	1.20	.60	.94	.38	7/16
2-4 FBZ	2MSC4N	200-1-4	1/8	1/4	1.40	.60	1.14	.56	9/16
2-6 FBZ	2MSC6N	200-1-6	1/8	3/8	1.42	.60	1.16	.56	11/16
2-8 FBZ	2MSC8N	200-1-8	1/8	1/2	1.67	.60	1.41	.75	7/8
3-1 FBZ	3MSC1N	300-1-1	3/16	1/16	1.23	.64	.97	.38	7/16
3-2 FBZ	3MSC2N	300-1-2	3/16	1/8	1.23	.64	.97	.38	7/16
3-4 FBZ	3MSC4N	300-1-4	3/16	1/4	1.43	.64	1.17	.56	9/16
4-1 FBZ	4MSC1N	400-1-1	1/4	1/16	1.29	.70	1.00	.38	1/2
4-2 FBZ	4MSC2N	400-1-2	1/4	1/8	1.29	.70	1.00	.38	1/2
4-4 FBZ	4MSC4N	400-1-4	1/4	1/4	1.49	.70	1.20	.56	9/16
4-6 FBZ	4MSC6N	400-1-6	1/4	3/8	1.51	.70	1.22	.56	11/16
4-8 FBZ	4MSC8N	400-1-8	1/4	1/2	1.76	.70	1.47	.75	7/8
4-12 FBZ	4MSC12N	400-1-12	1/4	3/4	1.82	.70	1.53	.75	1-1/16
5-2 FBZ	5MSC2N	500-1-2	5/16	1/8	1.34	.73	1.05	.38	9/16
5-4 FBZ	5MSC4N	500-1-4	5/16	1/4	1.52	.73	1.23	.56	9/16
5-6 FBZ	5MSC6N	500-1-6	5/16	3/8	1.55	.73	1.25	.56	11/16
5-8 FBZ	5MSC8N	500-1-8	5/16	1/2	1.79	.73	1.5	.75	7/8
6-2 FBZ	6MSC2N	600-1-2	3/8	1/8	1.38	.76	1.09	.38	5/8
6-4 FBZ	6MSC4N	600-1-4	3/8	1/4	1.57	.76	1.28	.56	5/8
6-6 FBZ	6MSC6N	600-1-6	3/8	3/8	1.57	.76	1.28	.56	11/16
6-8 FBZ	6MSC8N	600-1-8	3/8	1/2	1.82	.76	1.53	.75	7/8
6-12 FBZ	6MSC12N	600-1-12	3/8	3/4	1.88	.76	1.59	.75	1-1/16
8-2 FBZ	8MSC2N	810-1-2	1/2	1/8	1.53	.87	1.13	.38	13/16
8-4 FBZ	8MSC4N	810-1-4	1/2	1/4	1.71	.87	1.31	.56	13/16
8-6 FBZ	8MSC6N	810-1-6	1/2	3/8	1.71	.87	1.31	.56	13/16
8-8 FBZ	8MSC8N	810-1-8	1/2	1/2	1.93	.87	1.53	.75	7/8
8-12 FBZ	8MSC12N	810-1-12	1/2	3/4	1.99	.87	1.59	.75	1-1/16
8-16 FBZ	8MSC16N	810-1-16	1/2	1	2.28	.87	1.88	.94	1-3/8
10-6 FBZ	10MSC6N	1010-1-6	5/8	3/8	1.74	.87	1.34	.56	15/16
10-8 FBZ	10MSC8N	1010-1-8	5/8	1/2	1.93	.87	1.53	.75	15/16
10-12 FBZ	10MSC12N	1010-1-12	5/8	3/4	1.99	.87	1.59	.75	1-1/16
12-8 FBZ	12MSC8N	1210-1-8	3/4	1/2	1.99	.87	1.59	.75	1-1/16
12-12 FBZ	12MSC12N	1210-1-12	3/4	3/4	1.99	.87	1.59	.75	1-1/16
12-16 FBZ	12MSC16N	1210-1-16	3/4	1	2.28	.87	1.88	.94	1-3/8
14-12 FBZ	14MSC12N	1410-1-12	7/8	3/4	1.99	.87	1.59	.75	1-3/16
14-16 FBZ	14MSC16N	1410-1-16	7/8	1	2.28	.87	1.88	.94	1-3/8
16-8 FBZ	16MSC8N	1610-1-8	1	1/2	2.27	1.05	1.78	.75	1-3/8
16-12 FBZ	16MSC12N	1610-1-12	1	3/4	2.27	1.05	1.78	.75	1-3/8
16-16 FBZ	16MSC16N	1610-1-16	1	1	2.46	1.05	1.97	.94	1-3/8
20-20 FBZ	20MSC20N	2010-1-20	1-1/4	1-1/4	3.03	1.52	2.17	.97	1-3/4
24-24 FBZ	24MSC24N	2410-1-24	1-1/2	1-1/2	3.50	1.77	2.44	1.00	2-1/8
32-32 FBZ	32MSC32N	3210-1-32	2	2	4.47	2.47	3.00	1.04	2-3/4

NOTE: A and C dimensions are typical finger-tight.

Dimensions for reference only, subject to change.

Sizes 20, 24, 32 require additional lubrication prior to assembly.

Color Coding

For easy reference, table column headings are color indicated as follows:

fractional

metric

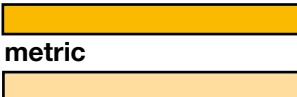

Tube to Male Pipe

NPT Male Connector For metric tube

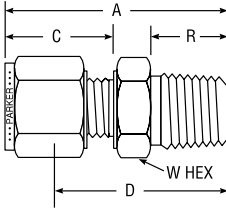
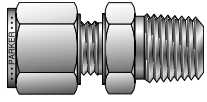

Single/Double Ferrule
Instrument Compression
Fittings

CPI™ PART NO.	A-LOK® PART NO.	INTER- CHANGES WITH	MILLIMETERS						
			TUBE O.D.	NPT PIPE THREAD	A	C	D	R	W HEX
FBZ 2-1/8	M2MSC1/8N	2MO-1-2	2	1/8	29,7	15,3	23,1	9,5	12,0
FBZ 3-1/8	M3MSC1/8N	3MO-1-2	3	1/8	29,7	15,3	23,1	9,5	12,0
FBZ 3-1/4	M3MSC1/4N	3MO-1-4	3	1/4	35,3	15,3	28,7	14,3	14,0
FBZ 4-1/8	M4MSC1/8N	4MO-1-2	4	1/8	31,2	16,1	24,6	9,5	12,0
FBZ 4-1/4	M4MSC1/4N	4MO-1-4	4	1/4	36,3	16,1	29,7	14,3	14,0
FBZ 6-1/8	M6MSC1/8N	6MO-1-2	6	1/8	32,9	17,7	25,4	9,5	14,0
FBZ 6-1/4	M6MSC1/4N	6MO-1-4	6	1/4	38,1	17,7	30,6	14,3	14,0
FBZ 6-3/8	M6MSC3/8N	6MO-1-6	6	3/8	38,5	17,7	31,0	14,3	18,0
FBZ 6-1/2	M6MSC1/2N	6MO-1-8	6	1/2	44,8	17,7	37,3	19,1	22,0
FBZ 8-1/8	M8MSC1/8N	8MO-1-2	8	1/8	34,2	18,6	26,7	9,5	15,0
FBZ 8-1/4	M8MSC1/4N	8MO-1-4	8	1/4	38,8	18,6	31,3	14,3	15,0
FBZ 8-3/8	M8MSC3/8N	8MO-1-6	8	3/8	39,3	18,6	31,8	14,3	18,0
FBZ 8-1/2	M8MSC1/2N	8MO-1-8	8	1/2	45,6	18,6	38,1	19,1	22,0
FBZ 10-1/8	M10MSC1/8N	10MO-1-2	10	1/8	36,1	19,5	28,6	9,5	18,0
FBZ 10-1/4	M10MSC1/4N	10MO-1-4	10	1/4	40,9	19,5	33,3	14,3	18,0
FBZ 10-3/8	M10MSC3/8N	10MO-1-6	10	3/8	40,9	19,5	33,3	14,3	18,0
FBZ 10-1/2	M10MSC1/2N	10MO-1-8	10	1/2	47,5	19,5	38,9	19,1	22,0
FBZ 10-3/4	M10MSC3/4N	10MO-1-12	10	3/4	46,4	19,5	38,9	19,1	27,0
FBZ 10-1	M10MSC1N	10MO-1-16	10	1	55,0	19,5	47,5	23,8	35,0
FBZ 12-1/4	M12MSC1/4N	12MO-1-4	12	1/4	43,4	22,0	33,3	14,3	22,0
FBZ 12-3/8	M12MSC3/8N	12MO-1-6	12	3/8	43,4	22,0	33,3	14,3	22,0
FBZ 12-1/2	M12MSC1/2N	12MO-1-8	12	1/2	49,0	22,0	38,9	19,1	22,0
FBZ 12-3/4	M12MSC3/4N	12MO-1-12	12	3/4	50,5	22,0	40,4	19,1	27,0
FBZ 14-1/4	M14MSC1/4N	14MO-1-4	14	1/4	44,2	22,0	34,1	14,3	24,0
FBZ 14-3/8	M14MSC3/8N	14MO-1-6	14	3/8	44,2	22,0	34,1	14,3	24,0
FBZ 14-1/2	M14MSC1/2N	14MO-1-8	14	1/2	49,0	22,0	38,9	19,1	24,0
FBZ 15-1/2	M15MSC1/2N	15MO-1-8	15	1/2	49,0	22,0	38,9	19,1	24,0
FBZ 16-3/8	M16MSC3/8N	16MO-1-6	16	3/8	44,1	22,0	34,01	14,3	24,0
FBZ 16-1/2	M16MSC1/2N	16MO-1-8	16	1/2	49,0	22,0	38,9	19,1	24,0
FBZ 16-3/4	M16MSC3/4N	16MO-1-12	16	3/4	50,5	22,0	40,5	19,1	27,0
FBZ 18-1/2	M18MSC1/2N	18MO-1-8	18	1/2	50,6	22,0	40,5	19,1	27,0
FBZ 18-3/4	M18MSC3/4N	18MO-1-12	18	3/4	50,6	22,0	40,5	19,1	27,0
FBZ 20-1/2	M20MSC1/2N	20MO-1-8	20	1/2	50,6	22,0	42,2	19,1	30,0
FBZ 20-3/4	M20MSC3/4N	20MO-1-12	20	3/4	52,3	22,0	42,2	19,1	30,0
FBZ 20-1	M20MSC1N	20MO-1-16	20	1	57,7	22,0	47,6	23,8	35,0
FBZ 22-3/4	M22MSC3/4N	22MO-1-12	22	3/4	52,3	22,0	42,2	19,1	35,0
FBZ 24-1/2	M25MSC1/2N	25MO-1-8	25	1/2	57,5	26,5	45,3	19,1	35,0
FBZ 25-3/4	M25MSC3/4N	25MO-1-12	25	3/4	57,5	26,5	45,2	19,1	35,0
FBZ 25-1	M25MSC1N	25MO-1-16	25	1	62,3	26,5	50,0	23,8	35,0
	M28MSC1N	28MO-1-16	28	1	73,0	36,6	38,6	23,9	41,0
	M30NSC1N	30MO-1-16	30	1	76,3	39,6	41,7	23,9	46,0
	M30NSC11/4N	30MO-1-20	30	1 1/4	77,2	39,6	41,7	24,7	46,0
	M32MSC11/2N	32MO-1-24	32	1 1/2	79,5	42,0	44,1	25,4	46,0

NOTE: A and C dimensions are typical finger-tight.

Dimensions for reference only, subject to change.

Tube to Male Pipe

BSP Taper Male Connector

For fractional tube

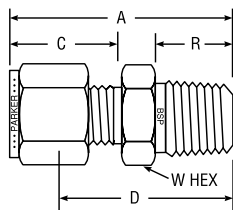
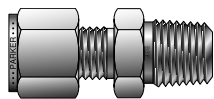

CPI™ PART NO.	A-LOK® PART NO.	INTER- CHANGES WITH	INCHES							
			TUBE O.D.	BSPT THREAD	A	C	D	R	W HEX	BORE
2-2K FBZ	2MSC2K	200-1-2RT	1/8	1/8	1.20	.60	0.94	.38	7/16	.19
2-4K FBZ	2MSC4K	200-1-4RT	1/8	1/4	1.40	.60	1.14	.56	9/16	.19
4-2K FBZ	4MSC2K	400-1-2RT	1/4	1/8	1.30	.70	1.00	.38	1/2	.19
4-4K FBZ	4MSC4K	400-1-4RT	1/4	1/4	1.50	.70	1.20	.56	9/16	.19
4-6K FBZ	4MSC6K	400-1-6RT	1/4	3/8	1.52	.70	1.22	.56	11/16	.19
4-8K FBZ	4MSC8K	400-1-8RT	1/4	1/2	1.77	.70	1.47	.75	7/8	.19
5-2K FBZ	5MSC2K	500-1-2RT	5/16	1/8	1.34	.73	1.05	.38	9/16	.19
5-4K FBZ	5MSC4K	500-1-4RT	5/16	1/4	1.52	.73	1.23	.56	9/16	.19
6-2K FBZ	6MSC2K	600-1-2RT	3/8	1/8	1.39	.76	1.09	.38	5/8	.19
6-4K FBZ	6MSC4K	600-1-4RT	3/8	1/4	1.57	.76	1.28	.56	5/8	.28
6-6K FBZ	6MSC6K	600-1-6RT	3/8	3/8	1.57	.76	1.28	.56	11/16	.28
6-8K FBZ	6MSC8K	600-1-8RT	3/8	1/2	1.82	.76	1.53	.75	7/8	.28
8-4K FBZ	8MSC4K	810-1-4RT	1/2	1/4	1.69	.86	1.31	.56	13/16	.28
8-6K FBZ	8MSC6K	810-1-6RT	1/2	3/8	1.69	.86	1.31	.56	13/16	.38
8-8K FBZ	8MSC8K	810-1-8RT	1/2	1/2	1.91	.66	1.53	.75	7/8	.41

NOTE: A and C dimensions are typical finger-tight.

Dimensions for reference only, subject to change.

BSP Taper Male Connector

For metric tube

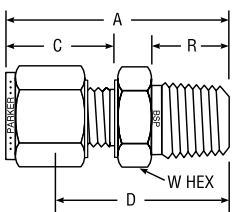
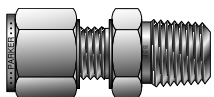

CPI™ PART NO.	A-LOK® PART NO.	INTER- CHANGES WITH	MILLIMETERS						
			TUBE O.D.	BSPT THREAD	A	C	D	R	W HEX
FBZ 2-1/8K	M2MSC1/8K	2MO-1-2RT	2	1/8	29,7	15,3	23,1	9,5	12,0
FBZ 3-1/8K	M3MSC1/8K	3MO-1-2RT	3	1/8	29,7	15,3	23,1	9,7	12,0
FBZ 3-1/4K	M3MSC1/4K	3MO-1-4RT	3	1/4	35,3	15,3	28,7	14,2	14,0
FBZ 4-1/8K	M4MSC1/8K	4MO-1-2RT	4	1/8	31,2	16,1	24,6	9,7	12,0
FBZ 4-1/4K	M4MSC1/4K	4MO-1-4RT	4	1/4	36,3	16,1	29,7	14,2	14,0
FBZ 6-1/8K	M6MSC1/8K	6MO-1-2RT	6	1/8	32,9	17,7	25,4	9,7	14,0
FBZ 6-1/4K	M6MSC1/4K	6MO-1-4RT	6	1/4	40,0	17,7	30,5	14,2	14,0
FBZ 6-3/8K	M6MSC3/8K	6MO-1-6RT	6	3/8	38,5	17,7	31,0	14,2	18,0
FBZ 6-1/2K	M6MSC1/2K	6MO-1-8RT	6	1/2	45,6	17,7	38,1	19,1	22,0
FBZ 8-1/8K	M8MSC1/8K	8MO-1-2RT	8	1/8	33,9	18,6	26,4	9,5	15,0
FBZ 8-1/4K	M8MSC1/4K	8MO-1-4RT	8	1/4	38,7	18,6	31,2	14,2	15,0
FBZ 8-3/8K	M8MSC3/8K	8MO-1-6RT	8	3/8	39,3	18,6	31,8	14,2	18,0
FBZ 8-1/2K	M8MSC1/2K	8MO-1-8RT	8	1/2	45,6	18,6	38,1	19,1	22,0
FBZ 10-1/8K	M10MSC1/8K	10MO-1-2RT	10	1/8	36,2	19,5	28,6	9,5	18,0
FBZ 10-1/4K	M10MSC1/4K	10MO-1-4RT	10	1/4	40,9	19,5	33,3	14,2	18,0
FBZ 10-3/8K	M10MSC3/8K	10MO-1-6RT	10	3/8	40,9	19,5	33,3	14,2	18,0
FBZ 10-1/2K	M10MSC1/2K	10MO-1-8RT	10	1/2	46,5	19,5	38,9	19,1	22,0
FBZ 12-1/4K	M12MSC1/4K	12MO-1-4RT	12	1/4	43,4	22,0	33,3	14,2	22,0
FBZ 12-3/8K	M12MSC3/8K	12MO-1-6RT	12	3/8	43,4	22,0	33,3	14,2	22,0
FBZ 12-1/2K	M12MSC1/2K	12MO-1-8RT	12	1/2	49,0	22,0	38,9	19,1	22,0
FBZ 12-3/4K	M12MSC3/4K	12MO-1-12RT	12	3/4	49,5	22,0	40,4	19,1	27,0
FBZ 15-1/2K	M15MSC1/2K	15MO-1-8RT	15	1/2	49,0	22,0	38,9	19,1	24,0
FBZ 16-3/8K	M16MSC3/8K	16MO-1-6RT	16	3/8	44,2	22,0	34,1	14,2	24,0
FBZ 16-1/2K	M16MSC1/2K	16MO-1-8RT	16	1/2	49,0	22,0	38,9	19,1	24,0
FBZ 16-3/4K	M16MSC3/4K	16MO-1-12RT	16	3/4	49,5	22,0	40,5	19,1	27,0
FBZ 18-1/2K	M18MSC1/2K	18MO-1-8RT	18	1/2	50,6	22,0	40,4	19,1	27,0
FBZ 18-3/4K	M18MSC3/4K	18MO-1-12RT	18	3/4	50,6	22,0	40,4	19,1	27,0
FBZ 20-1/2K	M20MSC1/2K	20MO-1-8RT	20	1/2	52,3	22,0	42,2	19,1	30,0
FBZ 20-3/4K	M20MSC3/4K	20MO-1-12RT	20	3/4	52,3	22,0	42,2	19,1	30,0
FBZ 22-3/4K	M22MSC3/4K	22MO-1-12RT	22	3/4	52,3	22,0	42,2	19,1	30,0
FBZ 25-3/4K	M25MSC3/4K	25MO-1-12RT	25	3/4	57,5	26,5	45,2	19,1	35,0
FBZ 25-1K	M25MSC1K	25MO-1-16RT	25	1	62,3	26,5	50,0	23,9	35,0

NOTE: A and C dimensions are typical finger-tight.

Dimensions for reference only, subject to change.

Color Coding

For easy reference, table column headings are color indicated as follows:

fractional



metric



Tube to Male Pipe

BSPF Male Connector For fractional tube

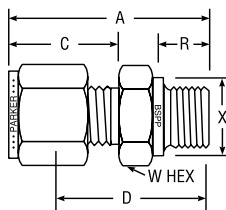
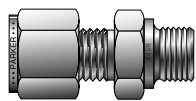

Single/Double Ferrule
Instrument Compression
Fittings

CPI™ PART NO.	A-LOK® PART NO.	INTER- CHANGES WITH	INCHES								
			TUBE O.D.	BSPF THREAD	A	C	D	R	X	W HEX	BORE
2-2R FBZ	2MSC2R	200-1-2RS	1/8	1/8	1.18	.60	0.92	.28	0.54	9/16	.16
2-4R FBZ	2MSC4R	200-1-4RS	1/8	1/4	1.27	.60	1.13	.44	0.70	3/4	.09
2-6R FBZ	2MSC6R	200-1-6RS	1/8	3/8	1.46	.60	1.17	.44	0.86	7/8	.28
4-2R FBZ	4MSC2R	400-1-2RS	1/4	1/8	1.28	.70	0.98	.28	0.54	9/16	.16
4-4R FBZ	4MSC4R	400-1-4RS	1/4	1/4	1.49	.70	1.19	.44	0.70	3/4	.19
4-6R FBZ	4MSC6R	400-1-6RS	1/4	3/8	1.55	.70	1.25	.44	0.86	7/8	.19
4-8R FBZ	4MSC8R	400-1-8RS	1/4	1/2	1.77	.70	1.47	.56	1.01	1-1/16	.19
6-2R FBZ	6MSC2R	600-1-2RS	3/8	1/8	1.35	.76	1.06	.28	0.54	5/8	.16
6-4R FBZ	6MSC4R	600-1-4RS	3/8	1/4	1.54	.76	1.25	.44	0.70	3/4	.25
6-6R FBZ	6MSC6R	600-1-6RS	3/8	3/8	1.57	.76	1.28	.44	0.86	7/8	.28
6-8R FBZ	6MSC8R	600-1-8RS	3/8	1/2	1.82	.76	1.53	.56	1.01	1-1/16	.28
8-4R FBZ	8MSC4R	810-1-4RS	1/2	1/4	1.66	.86	1.28	.44	0.70	13/16	.25
8-6R FBZ	8MSC6R	810-1-6RS	1/2	3/8	1.69	.86	1.31	.44	0.86	7/8	.31
8-8R FBZ	8MSC8R	810-1-8RS	1/2	1/2	1.91	.86	1.53	.56	1.01	1-1/16	.41
12-8R FBZ	12MSC8R	1210-1-8RS	3/4	1/2	1.93	.86	1.53	.56	1.01	1-1/16	.41
12-12R FBZ	12MSC12R	1210-1-12RS	3/4	3/4	2.07	.86	1.69	.63	1.25	1-3/8	.63
16-8R FBZ	16MSC8R	1610-1-8RS	1	1/2	2.21	1.04	1.72	.56	1.01	1-3/8	.41
16-16R FBZ	16MSC16R	1610-1-16RS	1	1	2.35	1.04	1.88	.72	1.52	1-5/8	.88

NOTE: A and C dimensions are typical finger-tight.

Dimensions for reference only, subject to change.

Sealing washer must be used with BSPF end shown ISO228/1 (Form A). See page 105.
For Form B undercut change part number and add B before R. e.g. M6MSC1/4BR.

BSPF Male Connector For metric tube

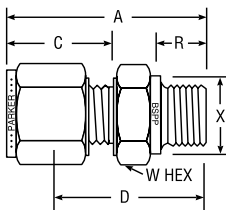
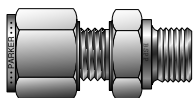

CPI™ PART NO.	A-LOK® PART NO.	INTER- CHANGES WITH	MILLIMETERS								
			TUBE O.D.	BSPF THREAD	A	C	D	R	X	W HEX	
FBZ 2-1/8R	M2MSC1/8R	2MO-1-2RS	2	1/8	28,4	15,3	21,8	7,1	14,0	13,7	
FBZ 3-1/8R	M3MSC1/8R	3MO-1-2RS	3	1/8	30,0	15,3	23,4	7,1	13,7	14,0	
FBZ 3-1/4R	M3MSC1/4R	3MO-1-4RS	3	1/4	35,3	15,3	28,7	11,2	17,8	19,0	
FBZ 6-1/8R	M6MSC1/8R	6MO-1-2RS	6	1/8	32,5	17,7	25,0	7,1	13,7	14,0	
FBZ 6-1/4R	M6MSC1/4R	6MO-1-4RS	6	1/4	37,7	17,7	30,2	11,2	17,8	19,0	
FBZ 6-3/8R	M6MSC3/8R	6MO-1-6RS	6	3/8	39,0	17,7	31,5	11,2	21,8	22,0	
FBZ 6-1/2R	M6MSC1/2R	6MO-1-8RS	6	1/2	45,6	17,7	38,1	14,2	25,7	27,0	
FBZ 8-1/8R	M8MSC1/8R	8MO-1-2RS	8	1/8	33,1	18,6	25,6	7,1	15,0	13,7	
FBZ 8-1/4R	M8MSC1/4R	8MO-1-4RS	8	1/4	38,5	18,6	31,0	11,2	17,8	19,0	
FBZ 8-3/8R	M8MSC3/8R	8MO-1-6RS	8	3/8	39,8	18,6	32,3	11,2	21,8	22,0	
FBZ 8-1/2R	M8MSC1/2R	8MO-1-8RS	8	1/2	45,6	18,6	38,1	14,2	25,7	27,0	
FBZ 10-1/4R	M10MSC1/4R	10MO-1-4RS	10	1/4	39,4	19,5	31,8	11,2	17,8	19,0	
FBZ 10-3/8R	M10MSC3/8R	10MO-1-6RS	10	3/8	40,6	19,5	33,0	11,2	21,8	22,0	
FBZ 10-1/2R	M10MSC1/2R	10MO-1-8RS	10	1/2	46,5	19,5	38,9	14,2	25,7	27,0	
FBZ 12-1/4R	M12MSC1/4R	12MO-1-4RS	12	1/4	42,6	22,0	32,5	11,2	17,8	22,0	
FBZ 12-3/8R	M12MSC3/8R	12MO-1-6RS	12	3/8	43,1	22,0	33,0	11,2	21,8	22,0	
FBZ 12-1/2R	M12MSC1/2R	12MO-1-8RS	12	1/2	49,0	22,0	38,9	14,2	25,7	27,0	
FBZ 12-3/4R	M12MSC3/4R	12MO-1-12RS	12	3/4	52,8	22,0	42,7	16,0	31,8	35,0	
FBZ 16-3/8R	M16MSC3/8R	16MO-1-6RS	16	3/8	43,5	22,0	33,4	11,2	22,0	21,8	
FBZ 16-1/2R	M16MSC1/2R	16MO-1-8RS	16	1/2	49,0	22,0	38,9	14,2	26,0	27,0	
FBZ 18-1/2R	M18MSC1/2R	18MO-1-8RS	18	1/2	49,0	22,0	38,9	14,2	26,0	27,0	
FBZ 18-3/4R	M18MSC3/4R	18MO-1-12RS	18	3/4	53,1	22,0	43,0	16,0	35,0	32,0	
FBZ 20-1/2R	M20MSC1/2R	20MO-1-8RS	20	1/2	50,5	22,0	40,4	14,2	30,0	25,7	
FBZ 20-3/4R	M20MSC3/4R	20MO-1-12RS	20	3/4	52,8	22,0	42,7	16,0	32,0	35,0	
FBZ 22-3/4R	M22MSC3/4R	22MO-1-12RS	22	3/4	52,8	22,0	42,7	16,0	32,0	35,0	
FBZ 25-3/4R	M25MSC3/4R	25MO-1-12RS	25	3/4	59,8	26,5	47,6	16,0	35,0	31,8	
FBZ 25-1R	M25MSC1R	25MO-1-16RS	25	1	60,1	26,5	47,8	18,3	39,0	41,0	

NOTE: A and C dimensions are typical finger-tight.

Dimensions for reference only, subject to change.

Sealing washer must be used with BSPF end shown ISO228/1 (Form A). See page 105.
For Form B undercut, add a "B" before the "R." e.g. M6MSC1/4BR.

Tube to Male Pipe

BSPP Male Connector with ED Seal For fractional tube

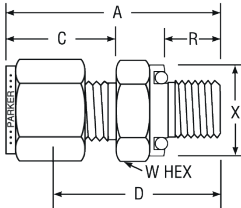
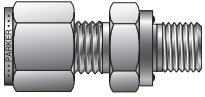

CPI™ PART NO.	A-LOK® PART NO.	INTER- CHANGES WITH	INCHES								
			TUBE O.D.	BSPP THREAD	A	C	D	R	X	W HEX	BORE
4-4R-ED FBZ	4MSC4R-ED	-	1/4	1/4	1.48	.70	1.19	.47	.74	3/4	.19
4-8R-ED FBZ	4MSC8R-ED	-	1/4	1/2	1.76	.70	1.38	.55	1.04	1-1/16	.19
6-6R-ED FBZ	6MSC6R-ED	-	3/8	3/8	1.60	.76	1.31	.47	.86	7/8	.28
8-4R-ED FBZ	8MSC4R-ED	-	1/2	1/4	1.69	.86	1.31	.47	.74	13/16	.25
8-6R-ED FBZ	8MSC6R-ED	-	1/2	3/8	1.69	.86	1.31	.47	.86	7/8	.31
8-8R-ED FBZ	8MSC8R-ED	-	1/2	1/2	1.85	.86	1.47	.55	1.04	1-1/16	.41
12-12R-ED FBZ	12MSC12R-ED	-	3/4	3/4	1.98	.86	1.59	.63	1.25	1-5/16	.63

NOTE: A and C dimensions are typical finger-tight.

Dimensions for reference only, subject to change.

ED fittings are supplied with sealing washers in nitrile as standard, suitable for temperatures of between -35°C and +100°C (-31°F to +212°F). Fluorocarbon seals are available upon request which are suitable for temperatures of between -25°C and +120°C (-13°F to +248°F).

Male Connector with ED Seal For metric tube

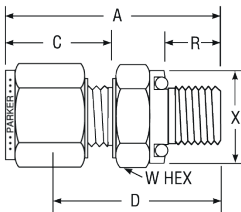
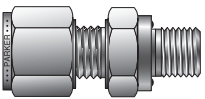

CPI™ PART NO.	A-LOK® PART NO.	INTER- CHANGES WITH	MILLIMETERS							
			TUBE O.D.	BSPP THREAD	A	C	D	R	X	W HEX
FBZ6-1/8R-ED	M6MSC1/8R-ED	-	6	1/8	32,5	17,7	25,0	7,9	13,7	14,0
FBZ6-1/4R-ED	M6MSC1/4R-ED	-	6	1/4	38,2	17,7	30,7	11,9	18,8	19,0
FBZ6-3/8R-ED	M6MSC3/8R-ED	-	6	3/8	39,5	17,7	32,0	11,9	21,8	22,0
FBZ6-1/2R-ED	M6MSC1/2R-ED	-	6	1/2	44,5	17,7	37,0	14,0	26,4	27,0
FBZ10-1/4R-ED	M10MSC1/4R-ED	-	10	1/4	40,0	19,5	32,3	11,9	18,8	19,0
FBZ10-3/8R-ED	M10MSC3/8R-ED	-	10	3/8	41,1	19,5	38,1	11,9	21,8	22,0
FBZ10-1/2R-ED	M10MSC1/2R-ED	-	10	1/2	46,0	19,5	38,4	14,0	26,4	27,0
FBZ12-1/4R-ED	M12MSC1/4R-ED	-	12	1/4	43,1	22,0	33,0	11,9	18,8	22,0
FBZ12-3/8R-ED	M12MSC3/8R-ED	-	12	3/8	43,6	22,0	33,5	11,9	21,8	22,0
FBZ12-1/2R-ED	M12MSC1/2R-ED	-	12	1/2	48,5	22,0	38,4	14,0	26,4	27,0

NOTE: A and C dimensions are typical finger-tight.

Dimensions for reference only, subject to change.

ED fittings are supplied with sealing washers in nitrile as standard, suitable for temperatures of between -35°C and +100°C (-31°F to +212°F). Fluorocarbon seals are available upon request which are suitable for temperatures of between -25°C and +120°C (-13°F to +248°F).

Color Coding

For easy reference, table column headings are color indicated as follows:

fractional



metric



Tube to Male Pipe

Single/Double Ferrule Instrument Compression Fittings

NPT Male Bulkhead Connector For fractional tube

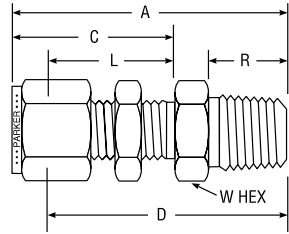
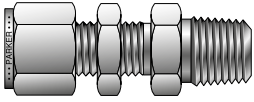

CPI™ PART NO.	A-LOK® PART NO.	INTER- CHANGES WITH	INCHES							
			TUBE O.D.	NPT PIPE THREAD	A	C	D	L	R	W HEX
1-1 FH2BZ	1MBC1N	100-11-1	1/16	1/16	1.19	0.68	1.038	.53	.38	5/16
1-2 FH2BZ	1MBC2N	100-11-2	1/16	1/8	1.27	0.68	1.116	.53	.38	7/16
2-2 FH2BZ	2MBC2N	200-11-2	1/8	1/8	1.83	1.23	1.571	.97	.38	1/2
3-2 FH2BZ	3MBC2N	300-11-2	3/16	1/8	1.89	1.26	1.634	1.00	.38	9/16
4-2 FH2BZ	4MBC2N	400-11-2	1/4	1/8	1.95	1.31	1.655	1.02	.38	5/8
4-4 FH2BZ	4MBC4N	400-11-4	1/4	1/4	2.132	1.31	1.842	1.02	.56	5/8
4-6 FH2BZ	4MBC6N	400-11-6	1/4	3/8	2.162	1.31	1.872	1.02	.56	11/16
4-8 FH2BZ	4MBC8N	400-11-8	1/4	1/2	2.374	1.31	2.084	1.02	.75	7/8
5-2 FH2BZ	5MBC2N	500-11-2	5/16	1/8	2.08	1.42	1.779	1.12	.38	11/16
5-4 FH2BZ	5MBC4N	500-11-4	5/16	1/4	2.27	1.42	1.966	1.12	.56	11/16
6-2 FH2BZ	6MBC2N	600-11-2	3/8	1/8	2.08	1.44	1.788	1.15	.38	3/4
6-4 FH2BZ	6MBC4N	600-11-4	3/8	1/4	2.265	1.44	1.975	1.15	.56	3/4
6-6 FH2BZ	6MBC6N	600-11-6	3/8	3/8	2.265	1.44	1.975	1.15	.56	3/4
6-8 FH2BZ	6MBC8N	600-11-8	3/8	1/2	2.48	1.44	2.219	1.15	.75	7/8
8-4 FH2BZ	8MBC4N	810-11-4	1/2	1/4	2.494	1.65	2.094	1.25	.56	15/16
8-6 FH2BZ	8MBC6N	810-11-6	1/2	3/8	2.494	1.65	2.094	1.25	.56	15/16
8-8 FH2BZ	8MBC8N	810-11-8	1/2	1/2	2.712	1.65	2.312	1.25	.75	15/16
8-12 FH2BZ	8MBC12N	810-11-12	1/2	3/4	2.722	1.65	2.322	1.25	.75	1-1/8
10-6 FH2BZ	10MBC6N	1010-11-6	5/8	3/8	2.628	1.68	2.228	1.28	.56	1-1/16
10-8 FH2BZ	10MBC8N	1010-11-8	5/8	1/2	2.816	1.68	2.416	1.28	.75	1-1/16
12-8 FH2BZ	12MBC8N	1210-11-8	3/4	1/2	3.00	1.87	2.601	1.47	.75	1-3/16
12-12 FH2BZ	12MBC12N	1210-11-12	3/4	3/4	3.00	1.87	2.601	1.47	.75	1-3/16
14-12 FH2BZ	14MBC12N	1410-11-12	7/8	3/4	3.31	2.09	2.913	1.69	.75	1-3/8
16-12 FH2BZ	16MBC12N	1610-11-12	1	3/4	3.54	2.27	3.006	1.78	.75	1-5/8
16-16 FH2BZ	16MBC16N	1610-11-16	1	1	3.72	2.27	3.194	1.78	.94	1-5/8

NOTE: A and C dimensions are typical finger-tight.

Dimensions for reference only, subject to change.

For bulkhead hole drill size and maximum bulkhead thickness, see page 61, Part BC.

NPT Male Bulkhead Connector For metric tube

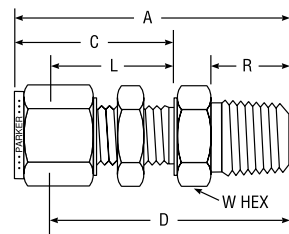
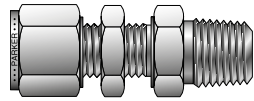

CPI™ PART NO.	A-LOK® PART NO.	INTER- CHANGES WITH	MILLIMETERS									
			TUBE O.D.	NPT THREAD	A	C	D	L	R	W HEX	B'HEAD HOLE DRILL SIZE	MAX. B'HEAD THICK.
FH2BZ 6-1/8	M6MBC1/8N	6MO-11-2	6	1/8	49,6	33,7	42,1	26,2	9,5	16,0	11,5	10,2
FH2BZ 6-1/4	M6MBC1/4N	6MO-11-4	6	1/4	53,5	33,7	46,0	26,2	14,3	16,0	11,5	10,2
FH2BZ 8-1/8	M8MBC1/8N	8MO-11-2	8	1/8	52,3	36,0	44,8	28,5	9,5	18,0	13,1	11,2
FH2BZ 8-1/4	M8MBC1/4N	8MO-11-4	8	1/4	57,5	36,0	50,0	28,5	14,3	18,0	13,1	11,2
FH2BZ 10-1/4	M10MBC1/4N	10MO-11-4	10	1/4	58,4	37,0	50,8	29,4	14,3	22,0	16,3	11,2
FH2BZ 10-3/8	M10MBC3/8N	10MO-11-6	10	3/8	58,4	37,0	50,8	29,4	14,3	22,0	16,3	11,2
FH2BZ 10-1/2	M10MBC1/2N	10MO-11-8	10	1/2	63,1	37,0	55,5	29,4	19,0	22,0	16,3	11,2
FH2BZ 12-1/4	M12MBC1/4N	12MO-11-4	12	1/4	63,3	10,1	53,2	31,8	14,3	24,0	19,5	12,7
FH2BZ 12-3/8	M12MBC3/8N	12MO-11-6	12	3/8	64,5	10,1	54,4	31,8	14,3	24,0	19,5	12,7
FH2BZ 12-1/2	M12MBC1/2N	12MO-11-8	12	1/2	67,5	10,1	57,4	31,8	19,0	24,0	19,5	12,7

NOTE: A and C dimensions are typical finger-tight.

Dimensions for reference only, subject to change.

Tube to Male Pipe

Thermocouple Connector For fractional tube

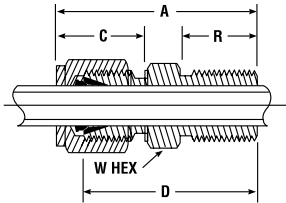
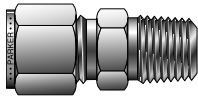

CPI™ PART NO.	A-LOK® PART NO.	INTER- CHANGES WITH	INCHES						
			TUBE O.D.	NPT PIPE THREAD	A	C	D	R	W HEX
1-1 FH4BZ	1MTC1N	100-1-1BT	1/16	1/16	0.93	.43	0.78	.38	5/16
1-2 FH4BZ	1MTC2N	100-1-2BT	1/16	1/8	1.03	.43	0.88	.38	7/16
1-4 FH4BZ	1MTC4N	100-1-4BT	1/16	1/4	1.23	.43	1.08	.56	9/16
2-1 FH4BZ	2MTC1N	200-1-1BT	1/8	1/16	1.17	.60	0.91	.38	3/8
2-2 FH4BZ	2MTC2N	200-1-2BT	1/8	1/8	1.20	.60	0.94	.38	7/16
2-4 FH4BZ	2MTC4N	200-1-4BT	1/8	1/4	1.40	.60	1.14	.56	9/16
3-2 FH4BZ	3MTC2N	300-1-2BT	3/16	1/8	1.23	.64	0.97	.38	7/16
3-4 FH4BZ	3MTC4N	300-1-4BT	3/16	1/4	1.43	.64	1.17	.56	9/16
4-2 FH4BZ	4MTC2N	400-1-2BT	1/4	1/8	1.29	.70	1.00	.38	1/2
4-4 FH4BZ	4MTC4N	400-1-4BT	1/4	1/4	1.49	.70	1.20	.56	9/16
4-6 FH4BZ	4MTC6N	400-1-6BT	1/4	3/8	1.60	.70	1.22	.56	11/16
4-8 FH4BZ	4MTC8N	400-1-8BT	1/4	1/2	1.87	.70	1.47	.75	7/8
5-4 FH4BZ	5MTC4N	500-1-4BT	5/16	1/4	1.52	.73	1.22	.56	9/16
6-4 FH4BZ	6MTC4N	600-1-4BT	3/8	1/4	1.57	.76	1.28	.56	5/8
6-6 FH4BZ	6MTC6N	600-1-6BT	3/8	3/8	1.57	.76	1.28	.56	11/16
6-8 FH4BZ	6MTC8N	600-1-8BT	3/8	1/2	1.82	.76	1.53	.75	7/8
6-12 FH4BZ	6MTC12N	600-1-12BT	3/8	3/4	1.88	.76	1.59	.75	1-1/16
8-8 FH4BZ	8MTC8N	810-1-8BT	1/2	1/2	1.93	.87	1.53	.76	7/8
8-12 FH4BZ	8MTC12N	810-1-12BT	1/2	3/4	1.99	.87	1.59	.75	1-1/16
10-12 FH4BZ	10MTC12N	1010-1-12BT	5/8	3/4	1.99	.87	1.59	.75	1-1/16
12-12 FH4BZ	12MTC12N	1210-1-12BT	3/4	3/4	1.99	.87	1.59	.75	1-1/16
16-16 FH4BZ	16MTC16N	1610-1-16BT	1	1	2.46	1.05	1.97	.94	1-3/8

NOTE: A and C dimensions are typical finger-tight.

Dimensions for reference only, subject to change.

Single/Double Ferrule
Instrument Compression
Fittings

NPT Male Elbow For fractional tube

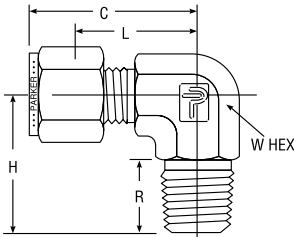
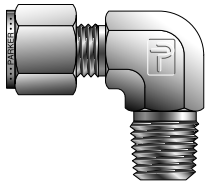

CPI™ PART NO.	A-LOK® PART NO.	INTER- CHANGES WITH	INCHES						
			TUBE O.D.	NPT PIPE THREAD	C	H	L	R	W HEX
1-1 CBZ	1MSEL1N	100-2-1	1/16	1/16	.75	0.70	.60	.38	7/16
1-2 CBZ	1MSEL2N	100-2-2	1/16	1/8	.75	0.70	.60	.38	7/16
2-1 CBZ	2MSEL1N	200-2-1	1/8	1/16	.93	0.70	.67	.38	7/16
2-2 CBZ	2MSEL2N	200-2-2	1/8	1/8	.93	0.70	.67	.38	7/16
2-4 CBZ	2MSEL4N	200-2-4	1/8	1/4	.97	0.93	.72	.56	9/16
3-2 CBZ	3MSEL2N	300-2-2	3/16	1/8	1.00	0.74	.74	.38	1/2
3-4 CBZ	3MSEL4N	300-2-4	3/16	1/4	1.00	0.93	.74	.56	9/16
4-1 CBZ	4MSEL1N	400-2-1	1/4	1/16	1.06	0.74	.77	.38	1/2
4-2 CBZ	4MSEL2N	400-2-2	1/4	1/8	1.06	0.74	.77	.38	1/2
4-4 CBZ	4MSEL4N	400-2-4	1/4	1/4	1.06	0.93	.77	.56	9/16
4-6 CBZ	4MSEL6N	400-2-6	1/4	3/8	1.17	1.04	.88	.56	11/16
4-8 CBZ	4MSEL8N	400-2-8	1/4	1/2	1.25	1.31	.96	.75	13/16
5-2 CBZ	5MSEL2N	500-2-2	5/16	1/8	1.13	0.79	.84	.38	9/16
5-4 CBZ	5MSEL4N	500-2-4	5/16	1/4	1.13	0.97	.84	.56	9/16
6-2 CBZ	6MSEL2N	600-2-2	3/8	1/8	1.20	0.82	.91	.38	5/8
6-4 CBZ	6MSEL4N	600-2-4	3/8	1/4	1.20	1.01	.91	.56	5/8
6-6 CBZ	6MSEL6N	600-2-6	3/8	3/8	1.23	1.13	.97	.56	11/16
6-8 CBZ	6MSEL8N	600-2-8	3/8	1/2	1.31	1.31	1.02	.75	13/16
6-12 CBZ	6MSEL12N	600-2-12	3/8	3/4	1.46	1.46	1.17	.75	1-1/16
8-4 CBZ	8MSEL4N	810-2-4	1/2	1/4	1.42	1.12	1.02	.56	13/16
8-6 CBZ	8MSEL6N	810-2-6	1/2	3/8	1.42	1.12	1.02	.56	13/16
8-8 CBZ	8MSEL8N	810-2-8	1/2	1/2	1.42	1.31	1.02	.75	13/16
8-12 CBZ	8MSEL12N	810-2-12	1/2	3/4	1.57	1.46	1.17	.75	1-1/16
10-6 CBZ	10MSEL6N	1010-2-6	5/8	3/8	1.50	1.20	1.10	.56	15/16
10-8 CBZ	10MSEL8N	1010-2-8	5/8	1/2	1.50	1.39	1.10	.75	15/16
10-12 CBZ	10MSEL12N	1010-2-12	5/8	3/4	1.57	1.46	1.17	.75	1-1/16
12-8 CBZ	12MSEL8N	1210-2-8	3/4	1/2	1.57	1.46	1.17	.75	1-1/16
12-12 CBZ	12MSEL12N	1210-2-12	3/4	3/4	1.57	1.46	1.17	.75	1-1/16
14-12 CBZ	14MSEL12N	1410-2-12	7/8	3/4	1.76	1.65	1.36	.75	1-3/8
16-12 CBZ	16MSEL12N	1610-2-12	1	3/4	1.93	1.65	1.45	.75	1-3/8
16-16 CBZ	16MSEL16N	1610-2-16	1	1	1.93	1.84	1.45	.94	1-3/8
20-20 CBZ	20MSEL20N	2010-2-20	1-1/4	1-1/4	2.61	1.88	1.75	.97	1-5/8
24-24 CBZ	24MSEL24N	2410-2-24	1-1/2	1-1/2	3.06	2.38	2.00	1.00	1-7/8
32-32 CBZ	32MSEL32N	3200-2-32	2	2	4.22	2.79	2.75	1.04	2-13/16

NOTE: C dimension is typical finger-tight.

Dimensions for reference only, subject to change.

Sizes 20, 24 require additional lubrication prior to assembly.

Color Coding

For easy reference, table column headings are color indicated as follows:

fractional



metric



Tube to Male Pipe

Single/Double Ferrule
Instrument Compression
Fittings

NPT Male Metric Elbow For metric tube

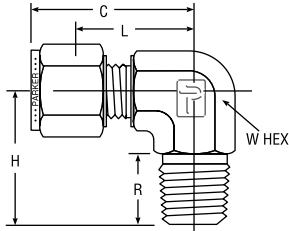
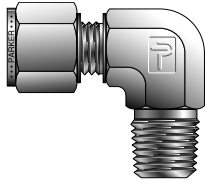

CPI™ PART NO.	A-LOK® PART NO.	INTER- CHANGES WITH	MILLIMETERS						INCHES
			TUBE O.D.	NPT THREAD	C	H	L	R	W HEX
CBZ 3-1/8	M3MSEL1/8N	3MO-2-2	3	1/8	23,6	17,8	17,0	9,7	7/16
CBZ 3-1/4	M3MSEL1/4N	3MO-2-4	3	1/4	24,6	23,4	18,0	14,2	1/2
CBZ 4-1/8	M4MSEL1/8N	4MO-2-2	4	1/8	25,4	18,8	19,2	9,7	1/2
CBZ 4-1/4	M4MSEL1/4N	4MO-2-4	4	1/4	26,2	25,4	19,6	14,2	1/2
CBZ 6-1/8	M6MSEL1/8N	6MO-2-2	6	1/8	27,0	18,8	19,6	9,7	1/2
CBZ 6-1/4	M6MSEL1/4N	6MO-2-4	6	1/4	27,0	23,4	19,6	14,2	1/2
CBZ 6-3/8	M6MSEL3/8N	6MO-2-6	6	3/8	29,8	26,2	22,4	14,2	11/16
CBZ 6-1/2	M6MSEL1/2N	6MO-2-8	6	1/2	31,8	33,0	24,4	19,0	13/16
CBZ 8-1/8	M8MSEL1/8N	8MO-2-2	8	1/8	28,8	19,8	21,3	9,7	9/16
CBZ 8-1/4	M8MSEL1/4N	8MO-2-4	8	1/4	28,8	24,4	21,3	14,2	9/16
CBZ 8-3/8	M8MSEL3/8N	8MO-2-6	8	3/8	30,6	26,2	23,1	14,2	11/16
CBZ 8-1/2	M8MSEL1/2N	8MO-2-8	8	1/2	32,7	33,0	25,2	19,1	13/16
CBZ 10-1/8	M10MSEL1/8N	10MO-2-8	10	1/8	31,5	21,6	23,9	9,7	11/16
CBZ 10-1/4	M10MSEL1/4N	10MO-2-4	10	1/4	31,5	26,2	23,9	14,2	11/16
CBZ 10-3/8	M10MSEL3/8N	10MO-2-6	10	3/8	31,5	26,2	23,9	14,2	11/16
CBZ 10-1/2	M10MSEL1/2N	10MO-2-8	10	1/2	33,5	33,0	25,9	19,0	13/16
CBZ 12-1/4	M12MSEL1/4N	12MO-2-4	12	1/4	36,0	28,2	25,9	14,2	13/16
CBZ 12-3/8	M12MSEL3/8N	12MO-2-6	12	3/8	36,0	28,2	25,9	14,2	13/16
CBZ 12-1/2	M12MSEL1/2N	12MO-2-8	12	1/2	36,0	33,0	25,9	19,0	13/16
CBZ 12-3/4	M12MSEL3/4N	12MO-2-12	12	3/4	39,8	36,8	29,7	19,0	1-1/16
CBZ 15-1/2	M15MSEL1/2N	15MO-2-8	15	1/2	38,0	35,1	27,9	19,0	15/16
CBZ 16-3/8	M16MSEL3/8N	16MO-2-6	16	3/8	38,0	30,2	27,9	14,2	15/16
CBZ 16-1/2	M16MSEL1/2N	16MO-2-8	16	1/2	38,0	35,1	27,9	19,0	15/16
CBZ 16-3/4	M16MSEL3/4N	16MO-2-12	16	3/4	39,8	36,8	29,7	19,0	1-1/16
CBZ 18-1/2	M18MSEL1/2N	18MO-2-8	18	1/2	39,8	36,8	29,7	19,0	1-1/16
CBZ 18-3/4	M18MSEL3/4N	18MO-2-12	18	3/4	39,8	36,8	29,7	19,0	1-1/16
CBZ 20-1/2	M20MSEL1/2N	20MO-2-8	20	1/2	44,6	41,7	34,5	19,0	1-3/8
CBZ 20-3/4	M20MSEL3/4N	20MO-2-12	20	3/4	44,6	41,7	34,5	19,0	1-3/8
CBZ 22-3/4	M22MSEL3/4N	22MO-2-12	22	3/4	44,6	41,7	34,5	19,0	1-3/8
CBZ 25-3/4	M25MSEL3/4N	25MO-2-12	25	3/4	49,1	41,7	36,8	19,0	1-3/8
CBZ 25-1	M25MSEL1N	25MO-2-16	25	1	49,1	46,5	36,8	23,9	1-3/8

NOTE: C dimension is typical finger-tight.

Dimensions for reference only, subject to change.

BSP Taper Male Elbow For fractional tube

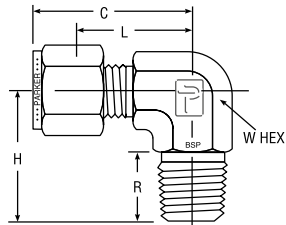
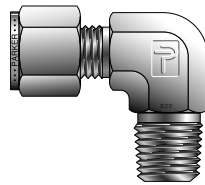

CPI™ PART NO.	A-LOK® PART NO.	INTER- CHANGES WITH	INCHES						
			TUBE O.D.	BSPT THREAD	C	H	L	R	W HEX
4-2K CBZ	4MSEL2K	400-2-2RT	1/4	1/8	1.06	0.75	0.77	.38	1/2
4-4K CBZ	4MSEL4K	400-2-4RT	1/4	1/4	1.06	0.94	0.77	.56	9/16
4-6K CBZ	4MSEL6K	400-2-6RT	1/4	3/8	1.17	1.05	0.88	.56	11/16
4-8K CBZ	4MSEL8K	400-2-8RT	1/4	1/2	1.25	1.32	0.96	.75	13/16
5-4K CBZ	5MSEL4K	500-2-4RT	5/16	1/4	1.13	0.98	0.84	.38	9/16
6-4K CBZ	6MSEL4K	600-2-4RT	3/8	1/4	1.20	1.02	0.91	.56	5/8
6-6K CBZ	6MSEL6K	600-2-4RT	3/8	3/8	1.23	1.05	0.97	.56	11/16
8-6K CBZ	8MSEL6K	810-2-6RT	1/2	3/8	1.42	1.13	1.02	.56	13/16
8-8K CBZ	8MSEL8K	810-2-8RT	1/2	1/2	1.42	1.32	1.02	.75	13/16

NOTE: C dimension is typical finger-tight.

Dimensions for reference only, subject to change.

Tube to Male Pipe

BSP Taper Male Elbow For metric tube

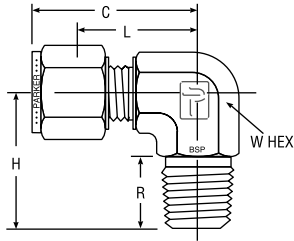
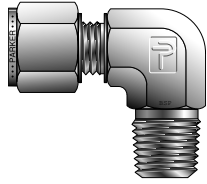

CPI™ PART NO.	A-LOK® PART NO.	INTER- CHANGES WITH	MILLIMETERS						INCHES	
			TUBE O.D.	BSPT THREAD	C	H	L	R	W HEX	
CBZ 3-1/8K	M3MSEL1/8K	3MO-2-2RT	3	1/8	23,6	17,8	17,0	9,7	7/16	
CBZ 3-1/4K	M3MSEL1/4K	3MO-2-4RT	3	1/4	24,6	23,4	18,0	14,2	1/2	
CBZ 4-1/8K	M4MSEL1/8K	4MO-2-2RT	4	1/8	25,4	18,8	18,8	9,7	1/2	
CBZ 4-1/4K	M4MSEL1/4K	4MO-2-4RT	4	1/4	24,6	23,4	18,8	14,2	1/2	
CBZ 6-1/8K	M6MSEL1/8K	6MO-2-2RT	6	1/8	27,0	18,8	19,6	9,7	1/2	
CBZ 6-1/4K	M6MSEL1/4K	6MO-2-4RT	6	1/4	27,0	23,4	19,6	14,2	1/2	
CBZ 6-3/8K	M6MSEL3/8K	6MO-2-6RT	6	3/8	29,8	26,2	22,4	14,2	11/16	
CBZ 6-1/2K	M6MSEL1/2K	6MO-2-8RT	6	1/2	31,8	33,0	24,4	19,0	13/16	
CBZ 8-1/8K	M8MSEL1/8K	8MO-2-2RT	8	1/8	28,8	19,8	21,3	9,7	9/16	
CBZ 8-1/4K	M8MSEL1/4K	8MO-2-4RT	8	1/4	28,8	24,4	21,3	14,2	9/16	
CBZ 8-3/8K	M8MSEL3/8K	8MO-2-6RT	8	3/8	30,6	26,2	23,1	14,2	11/16	
CBZ 8-1/2K	M8MSEL1/2K	8MO-2-8RT	8	1/2	32,7	33,0	25,2	19,1	13/16	
CBZ 10-1/8K	M10MSEL1/8K	10MO-2-2RT	10	1/8	31,5	21,6	23,9	9,7	11/16	
CBZ 10-1/4K	M10MSEL1/4K	10MO-2-4RT	10	1/4	31,5	26,2	23,9	14,2	11/16	
CBZ 10-3/8K	M10MSEL3/8K	10MO-2-6RT	10	3/8	31,5	26,2	23,9	14,2	11/16	
CBZ 10-1/2K	M10MSEL1/2K	10MO-2-8RT	10	1/2	33,5	33,0	25,9	19,0	13/16	
CBZ 12-1/4K	M12MSEL1/4K	12MO-2-4RT	12	1/4	36,0	28,2	25,9	14,2	13/16	
CBZ 12-3/8K	M12MSEL3/8K	12MO-2-6RT	12	3/8	36,0	28,2	25,9	14,2	13/16	
CBZ 12-1/2K	M12MSEL1/2K	12MO-2-8RT	12	1/2	36,0	33,0	25,9	19,0	13/16	
CBZ 12-3/4K	M12MSEL3/4K	12MO-2-12RT	12	3/4	39,8	36,8	29,7	19,1	1-1/16	
CBZ 16-3/8K	M16MSEL3/8K	16MO-2-6RT	16	3/8	38,0	30,2	27,9	14,2	15/16	
CBZ 16-1/2K	M16MSEL1/2K	16MO-2-8RT	16	1/2	38,0	35,1	27,9	19,0	15/16	
CBZ 18-1/2K	M18MSEL1/2K	18MO-2-8RT	18	1/2	39,8	36,8	29,7	19,0	1-1/16	
CBZ 18-3/4K	M18MSEL3/4K	18MO-2-12RT	18	3/4	39,8	36,8	29,7	19,0	1-1/16	
CBZ 20-3/4K	M20MSEL3/4K	20MO-2-12RT	20	3/4	44,6	41,7	34,5	19,0	1-3/8	
CBZ 25-3/4K	M25MSEL3/4K	25MO-2-12RT	25	3/4	49,0	41,7	36,8	19,1	1-3/8	
CBZ 25-1K	M25MSEL1K	25MO-2-16RT	25	1	49,1	46,5	36,8	23,9	1-3/8	

NOTE: C dimension is typical finger-tight.

Dimensions for reference only, subject to change.

Color Coding

For easy reference, table column headings are color indicated as follows:

fractional



metric



Tube to Male Pipe

Single/Double Ferrule Instrument Compression Fittings

NPT Male 45° Elbow For fractional tube

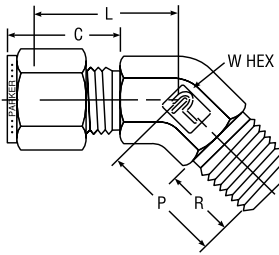
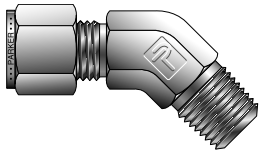

CPI™ PART NO.	A-LOK® PART NO.	INTER- CHANGES WITH	INCHES						
			TUBE O.D.	NPT PIPE THREAD	C	L	P	R	W HEX
1-1 VBZ	1MVEL1N	100-5-1	1/16	1/16	0.43	0.47	0.57	.38	7/16
2-2 VBZ	2MVEL2N	200-5-2	1/8	1/8	0.60	0.53	0.57	.38	7/16
3-2 VBZ	3MVEL2N	300-5-2	3/16	1/8	0.64	0.56	0.58	.38	7/16
4-2 VBZ	4MVEL2N	400-5-2	1/4	1/8	0.70	0.66	0.66	.38	9/16
4-4 VBZ	4MVEL4N	400-5-4	1/4	1/4	0.70	0.66	0.86	.56	9/16
5-2 VBZ	5MVEL2N	500-5-2	5/16	1/8	0.73	0.66	0.66	.38	9/16
6-2 VBZ	6MVEL2N	600-5-2	3/8	1/8	0.76	0.72	0.67	.38	9/16
6-4 VBZ	6MVEL4N	600-5-4	3/8	1/4	0.76	0.72	0.86	.56	9/16
6-6 VBZ	6MVEL6N	600-5-6	3/8	3/8	0.76	0.75	0.95	.56	3/4
8-6 VBZ	8MVEL6N	810-5-6	1/2	3/8	0.87	0.75	0.95	.56	3/4
10-8 VBZ	10MVEL8N	1010-5-8	5/8	1/2	0.87	0.84	1.20	.75	1-1/16
12-12 VBZ	12MVEL12N	1210-5-12	3/4	3/4	0.87	0.84	1.20	.75	1-1/16
14-12 VBZ	14MVEL12N	1410-5-8	7/8	3/4	0.87	1.36	1.27	.75	1-5/16
16-16 VBZ	16MVEL16N	1610-5-8	1	1	1.05	1.19	1.14	.94	1-5/16

NOTE: C dimension is typical finger-tight.

Dimensions for reference only, subject to change.

NPT Male 45° Elbow For metric tube

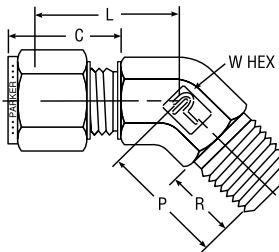
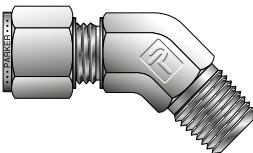

CPI™ PART NO.	A-LOK® PART NO.	INTER- CHANGES WITH	MILLIMETERS						
			TUBE O.D.	NPT PIPE THREAD	C	L	P	R	W HEX
VBZ 6-1/8	M6MVEL1/8N	6MO-5-2	6	1/8	17,7	16,0	16,8	9,5	14,0
VBZ 6-1/4	M6MVEL1/4N	6MO-5-4	6	1/4	17,7	16,0	21,8	14,3	14,0
VBZ 8-1/8	M8MVEL1/8N	8MO-5-2	8	1/8	18,6	16,8	16,8	9,5	14,0
VBZ 10-1/4	M10MVEL1/4N	10MO-5-4	10	1/4	19,5	19,0	24,1	14,3	19,0
VBZ 12-3/8	M12MVEL3/8N	12MO-5-6	12	3/8	22,0	19,0	24,1	14,3	19,0
VBZ 12-1/2	M12MVEL1/2N	12MO-5-8	12	1/2	22,0	20,6	29,7	19,0	22,0
VBZ 16-1/2	M16MVEL1/2N	16MO-5-8	16	1/2	22,0	20,6	29,7	19,0	22,0

NOTE: C dimension is typical finger-tight.

Dimensions for reference only, subject to change.

Tube to Male Pipe

NPT Male Run Tee For fractional tube

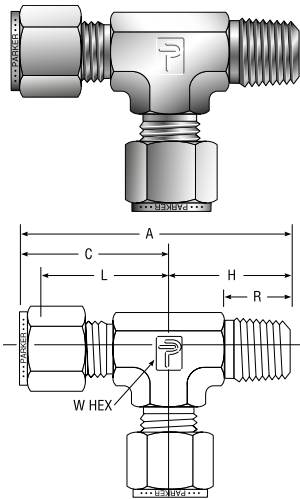

CPI™ PART NO.	A-LOK® PART NO.	INTER- CHANGES WITH	INCHES							
			TUBE O.D.	NPT PIPE THREAD	A	C	H	L	R	W HEX
2-2-2 RBZ	2MRT2N	200-3-2TMT	1/8	1/8	1.63	0.93	0.71	0.66	.38	7/16
2-4-2 RBZ	2MRT4N	200-3-4TMT	1/8	1/4	1.89	0.97	0.93	0.70	.56	9/16
3-2-3 RBZ	3MRT2N	300-3-2TMT	3/16	1/8	1.66	0.96	0.70	0.70	.38	7/16
4-2-4 RBZ	4MRT2N	400-3-2TMT	1/4	1/8	1.80	1.06	0.74	0.77	.38	1/2
4-4-4 RBZ	4MRT4N	400-3-4TMT	1/4	1/4	1.98	1.06	0.93	0.77	.56	1/2
5-2-5 RBZ	5MRT2N	500-3-2TMT	5/16	1/8	1.99	1.17	0.82	0.88	.38	5/8
5-4-5 RBZ	5MRT4N	500-3-4TMT	5/16	1/4	2.18	1.17	1.01	0.88	.56	5/8
6-4-6 RBZ	6MRT4N	600-3-4TMT	3/8	1/4	2.20	1.20	1.01	0.91	.56	5/8
6-6-6 RBZ	6MRT6N	600-3-6TMT	3/8	3/8	2.42	1.31	1.12	1.02	.56	13/16
8-6-8 RBZ	8MRT6N	810-3-6TMT	1/2	3/8	2.53	1.42	1.12	1.02	.56	13/16
8-8-8 RBZ	8MRT8N	810-3-8TMT	1/2	1/2	2.72	1.42	1.31	1.02	.75	7/8
10-8-10 RBZ	10MRT8N	1010-3-8TMT	5/8	1/2	2.88	1.50	1.39	1.10	.75	15/16
12-12-12 RBZ	12MRT12N	1210-3-12TMT	3/4	3/4	3.02	1.57	1.46	1.17	.75	1-1/16
14-12-14 RBZ	14MRT12N	1410-3-12TMT	7/8	3/4	3.41	1.76	1.65	1.36	.75	1-3/8
16-12-16 RBZ	16MRT12N	1610-3-12TMT	1	3/4	3.59	1.94	1.65	1.45	.75	1-3/8
16-16-16 RBZ	16MRT16N	1610-3-16TMT	1	1	3.78	1.94	1.84	1.45	.94	1-3/8

NOTE: A and C dimensions are typical finger-tight.

Dimensions for reference only, subject to change.

NPT Male Run Tee For metric tube

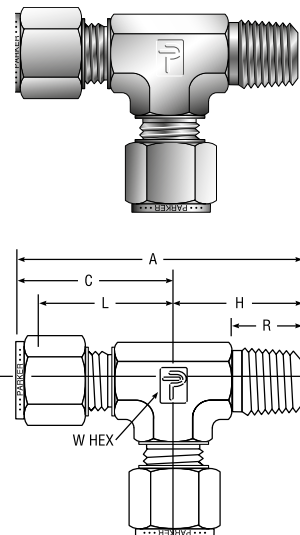

CPI™ PART NO.	A-LOK® PART NO.	INTER- CHANGES WITH	MILLIMETERS							INCHES	
			TUBE O.D.	NPT THREAD	A	C	H	L	R	W HEX	
RBZ 6-1/8-6	M6MRT1/8N	6MO-3-2TMT	6	1/8	45,8	27,0	18,0	19,6	9,7	1/2	
RBZ 6-1/4-6	M6MRT1/4N	6MO-3-4TMT	6	1/4	50,3	27,0	23,4	19,6	14,2	1/2	
RBZ 8-1/8-8	M8MRT1/8N	8MO-3-2TMT	8	1/8	50,7	29,9	20,8	22,4	9,7	5/8	
RBZ 8-1/4-8	M8MRT1/4N	8MO-3-4TMT	8	1/4	55,3	29,9	25,4	22,4	14,2	5/8	
RBZ 10-1/4-10	M10MRT1/4N	10MO-3-4TMT	10	1/4	61,7	33,5	28,2	25,9	14,2	13/16	
RBZ 10-1/2-10	M10MRT1/2N	10MO-3-8TMT	10	1/2	66,5	33,5	33,0	25,9	19,0	13/16	
RBZ 12-1/4-12	M12MRT1/4N	12MO-3-4TMT	12	1/4	64,2	36,0	28,2	25,9	14,2	13/16	
RBZ 12-3/8-12	M12MRT3/8N	12MO-3-6TMT	12	3/8	64,2	36,0	28,2	25,9	14,2	13/16	
RBZ 12-1/2-12	M12MRT1/2N	12MO-3-8TMT	12	1/2	69,0	36,0	33,0	25,9	19,0	13/16	
RBZ 16-1-16	M16MRT1N	16MO-3-16TMT	16	1	93,1	46,6	46,5	34,4	23,9	1-3/8	

NOTE: A and C dimensions are typical finger-tight.

Dimensions for reference only, subject to change.

Color Coding

For easy reference, table column headings are color indicated as follows:

fractional

metric

Tube to Male Pipe

NPT Male Branch Tee
For fractional tube

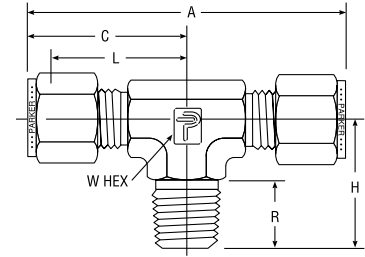
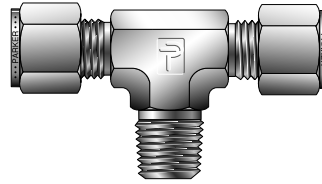

Single/Double Ferrule
Instrument Compression
Fittings

CPI™ PART NO.	A-LOK® PART NO.	INTER- CHANGES WITH	INCHES							
			TUBE O.D.	NPT PIPE THREAD	A	C	H	L	R	W HEX
2-2-2 SBZ	2MBT2N	200-3-2TTM	1/8	1/8	1.84	0.92	0.70	0.66	.38	7/16
2-2-4 SBZ	2MBT4N	200-3-4TTM	1/8	1/4	1.96	0.98	0.93	0.72	.56	1/2
3-3-2 SBZ	3MBT2N	300-3-2TTM	3/16	1/8	2.00	1.00	0.74	0.74	.38	1/2
4-4-2 SBZ	4MBT2N	400-3-2TTM	1/4	1/8	2.12	1.06	0.74	0.77	.38	1/2
4-4-4 SBZ	4MBT4N	400-3-4TTM	1/4	1/4	2.12	1.07	0.93	0.77	.56	1/2
5-5-2 SBZ	5MBT2N	500-3-2TTM	5/16	1/8	2.34	1.17	0.82	0.88	.38	5/8
5-5-4 SBZ	5MBT4N	500-3-4TTM	5/16	1/4	2.34	1.17	1.01	0.88	.56	5/8
6-6-4 SBZ	6MBT4N	600-3-4TTM	3/8	1/4	2.40	1.20	1.01	0.91	.56	5/8
6-6-6 SBZ	6MBT6N	600-3-6TTM	3/8	3/8	2.62	1.31	1.12	1.02	.56	13/16
8-8-6 SBZ	8MBT6N	810-3-6TTM	1/2	3/8	2.84	1.42	1.12	1.02	.56	13/16
8-8-8 SBZ	8MBT8N	810-3-8TTM	1/2	1/2	2.86	1.43	1.31	1.03	.75	7/8
10-10-8 SBZ	10MBT8N	1010-3-8TTM	5/8	1/2	2.86	1.53	1.42	1.13	.75	1
12-12-12 SBZ	12MBT12N	1210-3-12TTM	3/4	3/4	3.14	1.57	1.46	1.17	.75	1-1/16
14-14-12 SBZ	14MBT12N	1410-3-12TTM	7/8	3/4	3.52	1.76	1.65	1.36	.75	1-3/8
16-16-12 SBZ	16MBT12N	1610-3-12TTM	1	3/4	3.88	1.94	1.65	1.45	.75	1-3/8
16-16-16 SBZ	16MBT16N	1610-3-16TTM	1	1	3.88	1.94	1.84	1.45	.94	1-3/8

NOTE: A and C dimensions are typical finger-tight.

Dimensions for reference only, subject to change.

NPT Male Branch Tee
For metric tube

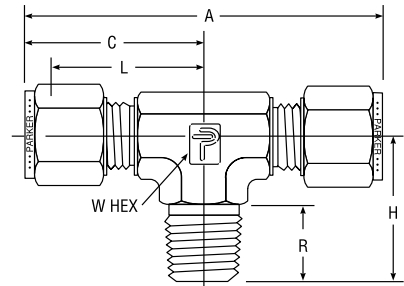
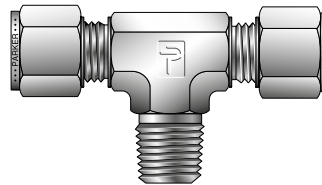

CPI™ PART NO.	A-LOK® PART NO.	INTER- CHANGES WITH	MILLIMETERS							INCHES
			TUBE O.D.	NPT THREAD	A	C	H	L	R	W HEX
SBZ 6-6-1/8	M6MBT1/8N	6MO-3TTM	6	1/8	53,9	27,0	18,8	19,6	9,7	1/2
SBZ 6-6-1/4	M6MBT1/4N	6MO-3-4TTM	6	1/4	53,9	27,0	23,4	19,6	14,2	1/2
SBZ 8-8-1/8	M8MBT1/8N	6MO-3-2TTM	8	1/8	59,7	29,9	20,8	22,4	9,7	5/8
SBZ 8-8-1/4	M8MBT1/4N	8MO-3-4TTM	8	1/4	59,7	29,9	25,4	22,4	14,2	5/8
SBZ 10-10-1/4	M10MBT1/4N	10MO-3-4TTM	10	1/4	67,0	33,5	28,2	25,9	14,2	13/16
SBZ 10-10-3/8	M10MBT3/8N	10MO-3-6TTM	10	3/8	67,0	33,5	28,2	25,9	14,2	13/16
SBZ 12-12-1/4	M12MBT1/4N	12MO-3-4TTM	12	1/4	72,0	36,0	28,2	25,9	14,2	13/16
SBZ 12-12-3/8	M12MBT3/8N	12MO-3-6TTM	12	3/8	72,0	36,0	28,2	25,9	14,2	13/16
SBZ 12-12-1/2	M12MBT1/2N	12MO-3-8TTM	12	1/2	72,0	36,0	33,0	25,9	19,0	13/16
SBZ 16-16-1/2	M16MBT1/2N	16MO-3-8TTM	16	1/2	77,6	38,8	35,8	28,7	19,1	1

NOTE: A and C dimensions are typical finger-tight.

Dimensions for reference only, subject to change.

Tube to Female Pipe

NPT Female Connector For fractional tube

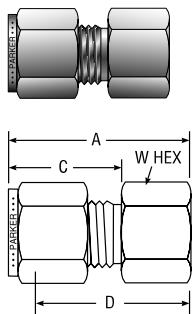

CPI™ PART NO.	A-LOK® PART NO.	INTER- CHANGES WITH	INCHES					
			TUBE O.D.	NPT PIPE THREAD	A	C	D	W HEX
1-1 GBZ	1FSC1N	100-7-1	1/16	1/16	0.93	0.43	0.78	7/16
1-2 GBZ	1FSC2N	100-7-2	1/16	1/8	0.95	0.43	0.81	9/16
2-2 GBZ	2FSC2N	200-7-2	1/8	1/8	1.14	0.60	0.88	9/16
2-4 GBZ	2FSC4N	200-7-4	1/8	1/4	1.32	0.60	1.06	3/4
3-2 GBZ	3FSC2N	300-7-2	3/16	1/8	1.17	0.64	0.91	9/16
3-4 GBZ	3FSC4N	300-7-4	3/16	1/4	1.35	0.64	1.09	3/4
4-2 GBZ	4FSC2N	400-7-2	1/4	1/8	1.23	0.70	0.94	9/16
4-4 GBZ	4FSC4N	400-7-4	1/4	1/4	1.42	0.70	1.13	3/4
4-6 GBZ	4FSC6N	400-7-6	1/4	3/8	1.48	0.70	1.19	7/8
4-8 GBZ	4FSC8N	400-7-8	1/4	1/2	1.67	0.70	1.38	1-1/16
5-2 GBZ	5FSC2N	500-7-2	5/16	1/8	1.27	0.73	0.97	9/16
5-4 GBZ	5FSC4N	500-7-4	5/16	1/4	1.46	0.73	1.16	3/4
5-6 GBZ	5FSC6N	500-7-6	5/16	3/8	1.51	0.73	1.22	7/8
6-2 GBZ	6FSC2N	600-7-2	3/8	1/8	1.29	0.76	1.00	5/8
6-4 GBZ	6FSC4N	600-7-4	3/8	1/4	1.48	0.76	1.19	3/4
6-6 GBZ	6FSC6N	600-7-6	3/8	3/8	1.54	0.76	1.25	7/8
6-8 GBZ	6FSC8N	600-7-8	3/8	1/2	1.73	0.76	1.44	1-1/16
6-12 GBZ	6FSC12N	600-7-12	3/8	3/4	1.85	0.76	1.56	1-1/4
8-4 GBZ	8FSC4N	810-7-4	1/2	1/4	1.59	0.87	1.19	13/16
8-6 GBZ	8FSC6N	810-7-6	1/2	3/8	1.65	0.87	1.25	7/8
8-8 GBZ	8FSC8N	810-7-8	1/2	1/2	1.84	0.87	1.44	1-1/16
8-12 GBZ	8FSC12N	810-7-12	1/2	3/4	1.96	0.87	1.56	1-1/4
10-6 GBZ	10FSC6N	1010-7-6	5/8	3/8	1.65	0.87	1.25	15/16
10-8 GBZ	10FSC8N	1010-7-8	5/8	1/2	1.84	0.87	1.44	1-1/16
10-12 GBZ	10FSC12N	1010-7-12	5/8	3/4	1.96	0.87	1.56	1-3/8
12-8 GBZ	12FSC8N	1210-7-8	3/4	1/2	1.84	0.87	1.44	1-1/16
12-12 GBZ	12FSC12N	1210-7-12	3/4	3/4	1.96	0.87	1.56	1-3/8
14-12 GBZ	14FSC12N	1410-7-12	7/8	3/4	1.96	0.87	1.56	1-3/8
16-12 GBZ	16FSC12N	1610-7-12	1	3/4	2.15	1.05	1.66	1-3/8
16-16 GBZ	16FSC16N	1610-7-16	1	1	2.46	1.05	1.97	1-5/8
20-20 GBZ	20FSC20N	2010-7-20	1-1/4	1-1/4	2.94	1.52	2.08	2
24-24 GBZ	24FSC24N	2410-7-24	1-1/2	1-1/2	3.28	1.77	2.22	2-3/8
32-32 GBZ	32FSC32N	3210-7-32	2	2	4.00	2.47	2.53	2-7/8

NOTE: A and C dimensions are typical finger-tight.

Dimensions for reference only, subject to change.

Sizes 20, 24, 32 require additional lubrication prior to assembly.

NPT Female Connector For metric tube

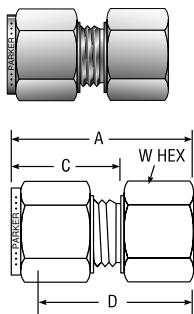

CPI™ PART NO.	A-LOK® PART NO.	INTER- CHANGES WITH	MILLIMETERS					
			TUBE O.D.	NPT THREAD	A	C	D	W HEX
GBZ 3-1/8	M3FSC1/8N	3MO-7-2	3	1/8	28,8	15,3	22,2	14,0
GBZ 3-1/4	M3FSC1/4N	3MO-7-4	3	1/4	33,6	15,3	27,0	19,0
GBZ 4-1/8	M4FSC1/8N	4MO-7-2	4	1/8	29,6	16,1	23,0	14,0
GBZ 6-1/8	M6FSC1/8N	6MO-7-2	6	1/8	31,3	17,7	23,8	14,0
GBZ 6-1/4	M6FSC1/4N	6MO-7-4	6	1/4	36,1	17,7	28,6	19,0
GBZ 6-3/8	M6FSC3/8N	6MO-7-6	6	3/8	37,7	17,7	30,2	22,0
GBZ 6-1/2	M6FSC1/2N	6MO-7-8	6	1/2	42,5	17,7	35,0	27,0
GBZ 8-1/8	M8FSC1/8N	8MO-7-2	8	1/8	32,1	18,6	24,6	14,0
GBZ 8-1/4	M8FSC1/4N	8MO-7-4	8	1/4	36,9	18,6	29,4	19,0
GBZ 8-3/8	M8FSC3/8N	8MO-7-6	8	3/8	38,5	18,6	31,0	22,0
GBZ 10-1/4	M10FSC1/4N	10MO-7-4	10	1/4	37,8	19,5	30,2	19,0
GBZ 10-3/8	M10FSC3/8N	10MO-7-6	10	3/8	39,4	19,5	31,8	22,0
GBZ 10-1/2	M10FSC1/2N	10MO-7-8	10	1/2	44,1	19,5	36,5	27,0
GBZ 12-1/4	M12FSC1/4N	12MO-7-4	12	1/4	41,9	22,0	31,8	22,0
GBZ 12-3/8	M12FSC3/8N	12MO-7-6	12	3/8	41,9	22,0	31,8	22,0
GBZ 12-1/2	M12FSC1/2N	12MO-7-8	12	1/2	46,6	22,0	36,5	27,0
GBZ 16-3/8	M16FSC3/8N	16MO-7-6	16	3/8	41,9	22,0	31,8	27,0
GBZ 16-1/2	M16FSC1/2N	16MO-7-8	16	1/2	46,9	22,0	36,5	27,0
GBZ 20-1/2	M20FSC1/2N	20MO-7-8	20	1/2	47,9	22,0	37,8	30,0
GBZ 20-3/4	M20FSC3/4N	20MO-7-12	20	3/4	49,7	22,0	39,6	35,0
GBZ 22-3/4	M22FSC3/4N	22MO-7-12	22	3/4	49,7	22,0	39,6	35,0
GBC 25-3/4	M25FSC3/4N	25MO-7-12	25	3/4	53,6	26,5	41,3	35,0
GBC 25-1	M25FSC1N	25MO-7-16	25	1	62,3	26,5	50,0	41,0

Dimensions for reference only, subject to change.

Single/Double Ferrule
Instrument Compression
Fittings

Tube to Female Pipe

Single/Double Ferrule Instrument Compression Fittings

BSP Taper Female Connector For fractional tube

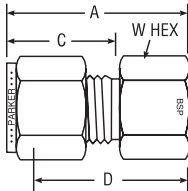
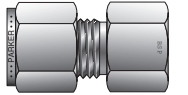

CPI™ PART NO.	A-LOK® PART NO.	INTER-CHANGES WITH	INCHES						
			TUBE O.D.	BSPT THREAD	A	C	D	W HEX	BORE
4-2K GBZ	4FSC2K	400-7-2RT	1/4	1/8	1.24	.70	0.94	9/16	.19
4-4K GBZ	4FSC4K	400-7-4RT	1/4	1/4	1.42	.70	1.13	3/4	.19
4-6K GBZ	4FSC6K	400-7-6RT	1/4	3/8	1.49	.70	1.19	7/8	.19
4-8K GBZ	4FSC8K	400-7-8RT	1/4	1/2	1.68	.70	1.38	1-1/16	.19
6-4K GBZ	6FSC4K	600-7-4RT	3/8	1/4	1.48	.76	1.19	3/4	.28
6-6K GBZ	6FSC6K	600-7-6RT	3/8	3/8	1.54	.76	1.25	7/8	.28
6-8K GBZ	6FSC8K	600-7-8RT	3/8	1/2	1.73	.76	1.44	1-1/16	.28
8-4K GBZ	8FSC4K	810-7-4RT	1/2	1/4	1.59	.87	1.19	13/16	.406
8-6K GBZ	8FSC6K	810-7-6RT	1/2	3/8	1.65	.87	1.25	7/8	.406
8-8K GBZ	8FSC8K	810-7-8RT	1/2	1/2	1.84	.87	1.44	1-1/16	.406

Dimensions for reference only, subject to change.

BSP Taper Female Connector For metric tube

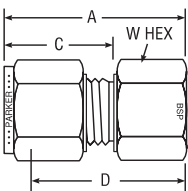
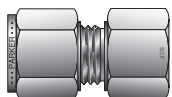

CPI™ PART NO.	A-LOK® PART NO.	INTER-CHANGES WITH	MILLIMETERS					
			TUBE O.D.	BSPT THREAD	A	C	D	W HEX
GBZ 3-1/8K	M3FSC1/8K	3MO-7-2RT	3	1/8	29,2	15,3	22,6	14,0
GBZ 6-1/8K	M6FSC1/8K	6MO-7-2RT	6	1/8	31,3	17,7	23,8	14,0
GBZ 6-1/4K	M6FSC1/4K	6MO-7-4RT	6	1/4	35,8	17,7	28,3	19,0
GBZ 6-3/8K	M6FSC3/8K	6MO-7-6RT	6	3/8	37,6	17,7	30,1	22,0
GBZ 6-1/2K	M6FSC1/2K	6MO-7-8RT	6	1/2	42,5	17,7	35,0	27,0
GBZ 8-1/8K	M8FSC1/8K	8MO-7-2RT	8	1/8	32,8	18,6	25,3	15,0
GBZ 8-1/4K	M8FSC1/4K	8MO-7-4RT	8	1/4	37,0	18,6	29,5	19,0
GBZ 8-3/8K	M8FSC3/8K	8MO-7-6RT	8	3/8	38,5	18,6	31,0	22,0
GBZ 8-1/2K	M8FSC1/2K	8MO-7-8RT	8	1/2	43,3	18,6	35,8	27,0
GBZ 10-1/8K	M10FSC1/8K	10MO-7-2RT	10	1/8	33,0	19,5	25,4	18,0
GBZ 10-1/4K	M10FSC1/4K	10MO-7-4RT	10	1/4	37,8	19,5	30,2	19,0
GBZ 10-3/8K	M10FSC3/8K	10MO-7-6RT	10	3/8	39,4	19,5	31,8	22,0
GBZ 10-1/2K	M10FSC1/2K	10MO-7-8RT	10	1/2	44,2	19,5	36,6	27,0
GBZ 12-1/4K	M12FSC1/4K	12MO-7-4RT	12	1/4	40,3	22,0	30,2	22,0
GBZ 12-3/8K	M12FSC3/8K	12MO-7-6RT	12	3/8	41,9	22,0	31,8	22,0
GBZ 12-1/2K	M12FSC1/2K	12MO-7-8RT	12	1/2	46,7	22,0	36,6	27,0
GBZ 16-1/2K	M16FSC1/2K	16MO-7-8RT	16	1/2	48,4	22,0	38,3	18,0
GBZ 20-1/2K	M20FSC1/2K	20MO-7-8RT	20	1/2	54,7	22,0	44,6	30,0
GBZ 20-3/4K	M20FSC3/4K	20MO-7-12RT	20	3/4	49,7	22,0	39,6	35,0
GBZ 22-1K	M22FSC1K	22MO-7-16RT	22	1	57,9	22,0	47,8	41,0
GBZ 25-3/4K	M25FSC3/4K	25MO-7-12RT	25	3/4	54,3	26,5	42,1	35,0
GBZ 25-1K	M25FSC1K	25MO-7-16RT	25	1	61,5	26,5	49,3	41,0

NOTE: A and C dimensions are typical finger-tight.

Dimensions for reference only, subject to change.

Color Coding

For easy reference, table column headings are color indicated as follows:

fractional



metric



Tube to Female Pipe

NPT Female Bulkhead Connector For fractional tube

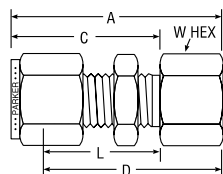
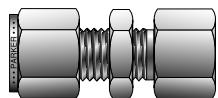

CPI™ PART NO.	A-LOK® PART NO.	INTER- CHANGES WITH	INCHES						
			TUBE O.D.	NPT PIPE THREAD	A	C	D	L	W HEX
2-2 GH2BZ	2FBC2N	200-71-2	1/8	1/8	1.76	1.23	1.50	0.97	9/16
3-2 GH2BZ	3FBC2N	300-71-2	3/16	1/8	1.79	1.26	1.53	1.00	9/16
4-2 GH2BZ	4FBC2N	400-71-2	1/4	1/8	1.85	1.31	1.56	1.02	5/8
4-4 GH2BZ	4FBC4N	400-71-4	1/4	1/4	2.04	1.31	1.75	1.02	3/4
5-2 GH2BZ	5FBC2N	500-71-2	5/16	1/8	1.96	1.42	1.66	1.12	11/16
5-8 GH2BZ	5FBC8N	500-71-8	5/16	1/2	2.38	1.42	2.08	1.12	1-1/16
6-4 GH2BZ	6FBC4N	600-71-4	3/8	1/4	2.17	1.44	1.88	1.15	3/4
8-6 GH2BZ	8FBC6N	810-71-6	1/2	3/8	2.43	1.65	2.03	1.25	15/16
8-8 GH2BZ	8FBC8N	810-71-8	1/2	1/2	2.62	1.65	2.22	1.25	1-1/16
10-8 GH2BZ	10FBC8N	1010-71-8	5/8	1/2	2.65	1.68	2.25	1.28	1-1/16
12-12 GH2BZ	12FBC12N	1210-71-12	3/4	3/4	2.90	1.87	2.50	1.47	1-3/8
14-12 GH2BZ	14FBC12N	1410-71-12	7/8	3/4	3.18	2.09	2.78	1.69	1-3/8
16-16 GH2BZ	16FBC16N	1610-71-16	1	1	3.68	2.27	3.19	1.78	1-5/8

NOTE: A and C dimensions are typical finger-tight.

Dimensions for reference only, subject to change.

For bulkhead hole drill size and maximum bulkhead thickness, see page 61, Part BC.

NPT Female Bulkhead Connector For metric tube

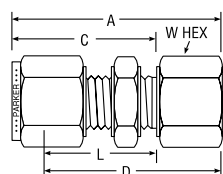
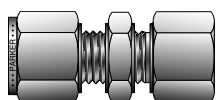

CPI™ PART NO.	A-LOK® PART NO.	INTER- CHANGES WITH	MILLIMETERS								
			TUBE O.D.	NPT THREAD	A	C	D	L	W HEX	B'HEAD HOLE DRILL SIZE	MAX. B'HEAD THICK.
GH2BZ 6-1/8	M6FBC1/8N	6MO-71-2	6	1/8	47,2	33,7	39,7	26,2	16,0	11,5	10,2
GH2BZ 6-1/4	M6FBC1/4N	6MO-71-4	6	1/4	52,0	33,7	44,5	26,2	19,0	11,5	10,2
GH2BZ 8-1/8	M8FBC1/8N	8MO-71-2	8	1/8	49,6	36,1	42,1	28,5	18,0	13,1	11,2
GH2BZ 10-1/4	M10FBC1/4N	10MO-71-4	10	1/4	55,2	37,0	47,6	29,4	19,0	16,3	11,2
GH2BZ 12-3/8	M12FBC3/8N	12MO-71-6	12	3/8	60,9	41,9	50,8	31,8	24,0	19,5	12,7
GH2BZ 12-1/2	M12FBC1/2N	12MO-71-8	12	1/2	66,4	41,9	56,3	31,8	27,0	19,5	12,7

NOTE: A and C dimensions are typical finger-tight.

Dimensions for reference only, subject to change.

For bulkhead hole drill size and maximum bulkhead thickness, see page 61, Part BC.

BSPP Gauge Connector For fractional tube

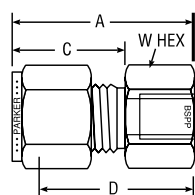
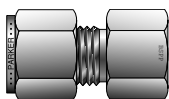

CPI™ PART NO.	A-LOK® PART NO.	INTER- CHANGES WITH	INCHES						
			TUBE O.D.	BSPP THREAD	A	C	D	W HEX	BORE
4-4GC GBZ	4FSC4GC	400-7-4RG	1/4	1/4	1.48	.70	1.19	3/4	.19
4-6GC GBZ	4FSC6GC	400-7-6RG	1/4	3/8	1.48	.70	1.19	7/8	.19
4-8GC GBZ	4FSC8GC	400-7-8RG	1/4	1/2	1.70	.70	1.41	1-1/16	.19
5-4GC GBZ	5FSC4GC	500-7-4RG	5/16	1/4	1.51	.73	1.22	3/4	.21
5-8GC GBZ	5FSC8GC	500-7-8RG	5/16	1/2	1.59	.73	1.30	1-1/16	.28
6-4GC GBZ	6FSC4GC	600-7-4RG	3/8	1/4	1.55	.76	1.25	3/4	.21
6-6GC GBZ	6FSC6GC	600-7-6RG	3/8	3/8	1.55	.76	1.25	7/8	.26
6-8GC GBZ	6FSC8GC	600-7-8RG	3/8	1/2	1.63	.76	1.33	1-1/16	.28
8-4GC GBZ	8FSC4GC	810-7-4RG	1/2	1/4	1.65	.86	1.25	13/16	.21
8-6GC GBZ	8FSC6GC	810-7-6RG	1/2	3/8	1.75	.86	1.35	7/8	.26
8-8GC GBZ	8FSC8GC	810-7-8RG	1/2	1/2	1.90	.86	1.50	1-1/16	.28

NOTE: A and C dimensions are typical finger-tight.

Dimensions for reference only, subject to change.

See pages 108-134 for detailed information.
Sealing Washer on page 105 to be used with this fitting.

Single/Double Ferrule
Instrument Compression
Fittings

Tube to Female Pipe

BSPG Gauge Connector For metric tube

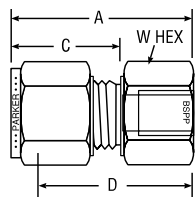
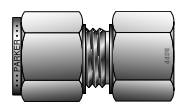

CPI™ PART NO.	A-LOK® PART NO.	INTER- CHANGES WITH	INCHES					
			TUBE O.D.	BSPG THREAD	A	C	D	W HEX
GBZ 3-1/4GC	M3GC1/4R	3MO-7-4RG	3	1/4	35,3	15,3	28,7	19,0
GBZ 6-1/4GC	M6GC1/4R	6MO-7-4RG	6	1/4	37,7	17,7	30,2	19,0
GBZ 6-3/8GC	M6GC3/8R	6MO-7-6RG	6	3/8	37,7	17,7	30,2	22,0
GBZ 6-1/2GC	M6GC1/2R	6MO-7-8RG	6	1/2	43,2	17,7	35,7	27,0
GBZ 8-1/4GC	M8GC1/4R	8MO-7-4RG	8	1/4	38,5	18,6	31,0	19,0
GBZ 8-3/8GC	M8GC3/8R	8MO-7-6RG	8	3/8	40,8	18,6	33,3	22,0
GBZ 8-1/2GC	M8GC1/2R	8MO-7-8RG	8	1/2	44,0	18,6	36,5	27,0
GBZ 10-1/4GC	M10GC1/4R	10MO-7-4RG	10	1/4	39,4	19,5	31,8	19,0
GBZ 10-3/8GC	M10GC3/8R	10MO-7-6RG	10	3/8	38,8	19,5	31,2	22,0
GBC 10-1/2GC	M10GC1/2R	10MO-7-8RG	10	1/2	41,3	19,5	33,7	27,0
GBC 12-1/4GC	M12GC1/4R	12MO-7-4RG	12	1/4	41,9	22,0	31,8	22,0
GBC 12-3/8GC	M12GC3/8R	12MO-7-6RG	12	3/8	44,4	22,0	34,3	22,0
GBC 12-1/2GC	M12GC1/2R	12MO-7-8RG	12	1/2	48,2	22,0	38,1	27,0

NOTE: A and C dimensions are typical finger-tight.

Dimensions for reference only, subject to change.

See pages 108 to 134 for detailed information.
Sealing Washer on page 105 to be used with this fitting.

Single/Double Ferrule
Instrument Compression
Fittings

NPT Female Elbow For fractional tube

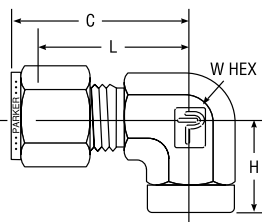
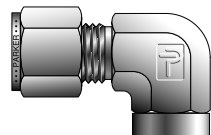

CPI™ PART NO.	A-LOK® PART NO.	INTER- CHANGES WITH	INCHES					
			TUBE O.D.	NPT PIPE THREAD	C	H	L	W HEX
1-1 DBZ	1FEL1N	100-8-1	1/16	1/16	0.75	0.50	0.60	7/16
1-2 DBZ	1FEL2N	100-8-2	1/16	1/8	0.79	0.75	0.64	9/16
2-2 DBZ	2FEL2N	200-8-2	1/8	1/8	0.97	0.75	0.71	9/16
2-4 DBZ	2FEL4N	200-8-4	1/8	1/4	1.10	0.88	0.84	3/4
3-2 DBZ	3FEL2N	300-8-2	3/16	1/8	1.00	0.75	0.74	9/16
4-2 DBZ	4FEL2N	400-8-2	1/4	1/8	1.06	0.75	0.77	9/16
4-4 DBZ	4FEL4N	400-8-4	1/4	1/4	1.20	0.88	0.91	11/16
4-6 DBZ	4FEL6N	400-8-6	1/4	3/8	1.25	0.88	0.96	13/16
4-8 DBZ	4FEL8N	400-8-8	1/4	1/2	1.36	1.13	1.07	1
5-2 DBZ	5FEL2N	500-8-2	5/16	1/8	1.13	0.75	0.84	9/16
5-4 DBZ	5FEL4N	500-8-4	5/16	1/4	1.24	0.88	0.94	11/16
6-2 DBZ	6FEL2N	600-8-2	3/8	1/8	1.20	0.75	0.91	5/8
6-4 DBZ	6FEL4N	600-8-4	3/8	1/4	1.26	0.88	0.97	11/16
6-6 DBZ	6FEL6N	600-8-6	3/8	3/8	1.31	0.88	1.02	13/16
6-8 DBZ	6FEL8N	600-8-8	3/8	1/2	1.42	1.13	1.13	1
8-4 DBZ	8FEL4N	810-8-4	1/2	1/4	1.42	0.88	1.02	13/16
8-6 DBZ	8FEL6N	810-8-6	1/2	3/8	1.42	0.88	1.02	13/16
8-8 DBZ	8FEL8N	810-8-8	1/2	1/2	1.53	1.13	1.13	1
10-6 DBZ	10FEL6N	1010-8-6	5/8	3/8	1.50	0.88	1.10	15/16
10-8 DBZ	10FEL8N	1010-8-8	5/8	1/2	1.57	1.13	1.17	1-1/16
12-8 DBZ	12FEL8N	1210-8-8	3/4	1/2	1.57	1.13	1.17	1-1/16
12-12 DBZ	12FEL12N	1210-8-12	3/4	3/4	1.76	1.25	1.36	1-3/8
14-12 DBZ	14FEL12N	1410-8-12	7/8	3/4	1.76	1.25	1.36	1-3/8
16-12 DBZ	16FEL12N	1610-8-12	1	3/4	1.93	1.25	1.45	1-3/8
16-16 DBZ	16FEL16N	1610-8-16	1	1	2.02	1.50	1.53	1-5/8

NOTE: C dimension is typical finger-tight.

Dimensions for reference only, subject to change.

NPT Female Elbow For metric tube

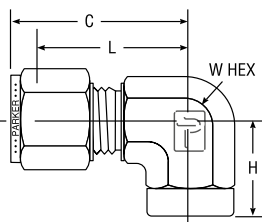

CPI™ PART NO.	A-LOK® PART NO.	INTER- CHANGES WITH	MILLIMETERS					INCHES
			TUBE O.D.	NPT THREAD	C	H	L	W HEX
DBZ 6-1/8	M6FEL1/8N	6MO-8-2	6	1/8	27,0	19,0	19,6	1/2
DBZ 6-1/4	M6FEL1/4N	6MO-8-4	6	1/4	29,8	22,4	22,4	11/16
DBZ 8-1/8	M8FEL1/8N	8MO-8-2	8	1/8	28,8	19,1	21,3	9/16
DBZ 8-1/4	M8FEL1/4N	8MO-8-4	8	1/4	30,6	22,4	23,1	11/16
DBZ 10-1/4	M10FEL1/4N	10MO-8-4	10	1/4	33,5	22,4	25,9	13/16
DBZ 10-3/8	M10FEL3/8N	10MO-8-6	10	3/8	33,5	22,4	25,9	13/16
DBZ 10-1/2	M10FEL1/2N	10MO-8-8	10	1/2	36,3	28,5	28,7	1
DBZ 12-1/4	M12FEL1/4N	12MO-8-4	12	1/4	36,0	22,4	25,9	13/16
DBZ 12-3/8	M12FEL3/8N	12MO-8-6	12	3/8	36,0	22,4	25,9	13/16
DBZ 12-1/2	M12FEL1/2N	12MO-8-8	12	1/2	38,8	28,4	28,7	1
DBZ 16-3/8	M16FEL3/8N	16MO-8-6	16	3/8	39,5	23,6	29,7	1-1/16
DBZ 16-1/2	M16FEL1/2N	16MO-8-8	16	1/2	39,5	28,4	29,7	1-1/16

NOTE: C dimension is typical finger-tight.

Dimensions for reference only, subject to change.

Tube to Female Pipe

NPT Female Run Tee For fractional tube

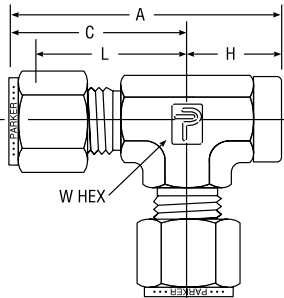
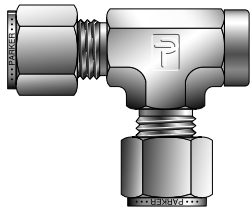

CPI™ PART NO.	A-LOK® PART NO.	INTER- CHANGES WITH	INCHES						
			TUBE O.D.	NPT PIPE THREAD	A	C	H	L	W HEX
2-2-2 MBZ	2FRT2N	200-3-2TFT	1/8	1/8	1.72	0.96	0.75	0.70	1/2
3-2-3 MBZ	3FRT2N	300-3-2TFT	3/16	1/8	1.76	1.01	0.75	0.74	1/2
4-2-4 MBZ	4FRT2N	400-3-2TFT	1/4	1/8	1.81	1.06	0.75	0.77	1/2
4-4-4 MBZ	4FRT4N	400-3-4TFT	1/4	1/4	2.05	1.17	0.88	0.88	11/16
5-2-5 MBZ	5FRT2N	500-3-2TFT	5/16	1/8	1.92	1.17	0.75	0.88	5/8
6-4-6 MBZ	6FRT4N	600-3-4TFT	3/8	1/4	2.11	1.23	0.88	0.94	11/16
8-4-8 MBZ	8FRT4N	810-3-4TFT	1/2	1/4	2.56	1.42	0.88	1.02	13/16
8-6-8 MBZ	8FRT6N	810-3-6TFT	1/2	3/8	2.30	1.42	0.88	1.02	7/8
8-8-8 MBZ	8FRT8N	810-3-8TFT	1/2	1/2	2.66	1.53	1.13	1.13	1
10-8-10 MBZ	10FRT8N	1010-3-8TFT	5/8	1/2	2.70	1.57	1.13	1.17	1-1/16
12-12-12 MBZ	12FRT12N	1210-3-12TFT	3/4	3/4	3.01	1.76	1.25	1.36	1-3/8
14-8-14 MBZ	14FRT8N	1410-3-8TFT	7/8	1/2	3.01	1.76	1.25	1.36	1-3/8
14-12-14 MBZ	14FRT12N	1410-3-12TFT	7/8	3/4	3.01	1.76	1.25	1.36	1-3/8
16-12-16 MBZ	16FRT12N	1610-3-12TFT	1	3/4	3.18	1.93	1.25	1.45	1-3/8
16-16-16 MBZ	16FRT16N	1610-3-16TFT	1	1	3.52	2.02	1.50	1.65	1-5/8

NOTE: A and C dimensions are typical finger-tight.

Dimensions for reference only, subject to change.

NPT Female Run Tee For metric tube

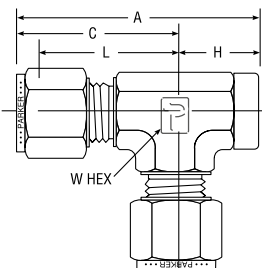
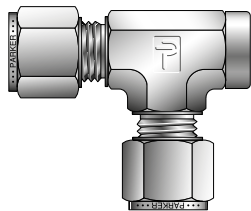

CPI™ PART NO.	A-LOK® PART NO.	INTER- CHANGES WITH	MILLIMETERS						INCHES
			TUBE O.D.	NPT THREAD	A	C	H	L	W HEX
MBZ 6-1/8-6	M6FRT1/8N	6MO-3TFT	6	1/8	46,0	27,0	19,0	19,6	1/2
MBZ 6-1/4-6	M6FRT1/4N	6MO-3-4TFT	6	1/4	52,1	29,8	22,4	22,4	11/16
MBZ 6-1/8-6	M8FRT1/8N	8MO-3TFT	8	1/8	48,9	29,9	19,0	22,4	5/8
MBZ 10-1/4-10	M10FRT1/4N	10MO-3TFT	10	1/4	55,9	33,5	22,4	25,9	13/16
MBZ 12-1/4-12	M12FRT1/4N	12MO-3-4TFT	12	1/4	58,4	36,0	22,4	25,9	13/16
MBZ 12-3/8-12	M12FRT3/8N	12MO-3TFT	12	3/8	58,4	36,0	22,4	25,9	13/16
MBZ 12-1/2-12	M12FRT1/2N	12MO-3-8TFT	12	1/2	67,3	38,8	28,5	28,7	1
MBZ 16-1/2-16	M16FRT1/2N	16MO-3TTF	16	1/2	68,2	39,8	28,4	29,7	1-1/16

NOTE: A and C dimensions are typical finger-tight.

Dimensions for reference only, subject to change.

Color Coding

For easy reference, table column headings are color indicated as follows:

fractional

metric

Tube to Female Pipe

NPT Female Branch Tee
For fractional tube

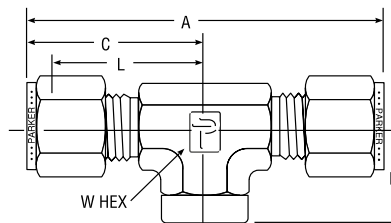

Single/Double Ferrule
Instrument Compression
Fittings

CPI™ PART NO.	A-LOK® PART NO.	INTER- CHANGES WITH	INCHES						
			TUBE O.D.	NPT PIPE THREAD	A	C	H	L	W HEX
2-2-2 OBZ	2FBT2N	200-3-2TTF	1/8	1/8	1.91	1.01	.075	0.70	1/2
3-3-2 OBZ	3FBT2N	300-3-2TTF	3/16	1/8	2.02	1.01	0.75	0.74	1/2
4-4-2 OBZ	4FBT2N	400-3-2TTF	1/4	1/8	2.12	1.06	0.75	0.77	1/2
4-4-4 OBZ	4FBT4N	400-3-4TTF	1/4	1/4	2.34	1.17	0.88	0.88	11/16
5-5-2 OBZ	5FBT2N	500-3-2TTF	5/16	1/8	2.34	1.17	0.75	0.88	5/8
6-6-4 OBZ	6FBT4N	600-3-4TTF	3/8	1/4	2.46	1.23	0.88	0.94	11/16
8-8-4 OBZ	8FBT4N	810-3-4TTF	1/2	1/4	2.84	1.42	0.88	1.02	13/16
8-8-6 OBZ	8FBT6N	810-3-6TTF	1/2	3/8	2.84	1.42	0.88	1.02	7/8
8-8-8 OBZ	8FBT8N	810-3-8TTF	1/2	1/2	3.06	1.53	1.13	1.13	1
10-10-8 OBZ	10FBT8N	1010-3-8TTF	5/8	1/2	3.06	1.53	1.13	1.13	1
12-12-12 OBZ	12FBT12N	1210-3-12TTF	3/4	3/4	3.52	1.76	1.25	1.36	1-3/8
14-14-12 OBZ	14FBT12N	1410-3-12TTF	7/8	3/4	3.52	1.76	1.25	1.36	1-3/8
16-16-12 OBZ	16FBT12N	1610-3-12TTF	1	3/4	3.86	1.94	1.25	1.45	1-3/8
16-16-16 OBZ	16FBT16N	1610-3-16TTF	1	1	4.28	2.14	1.50	1.65	1-5/8

NOTE: A and C dimensions are typical finger-tight.

Dimensions for reference only, subject to change.

NPT Female Branch Tee
For metric tube

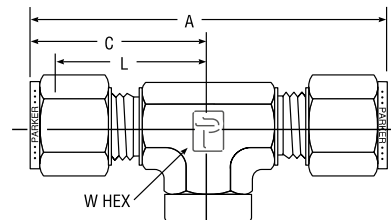

CPI™ PART NO.	A-LOK® PART NO.	INTER- CHANGES WITH	MILLIMETERS						INCHES
			TUBE O.D.	NPT THREAD	A	C	H	L	W HEX
OBZ 6-6-1/8	M6FBT1/8N	6MO-3TTF	6	1/8	53,9	27,0	19,0	19,6	1/2
OBZ 6-6-1/4	M6FBT1/4N	6MO-3-4TTF	6	1/4	59,5	29,8	22,4	22,4	11/16
OBZ 8-8-1/8	M8FBT1/8N	8MO-3TTF	8	1/8	59,7	29,9	19,0	22,4	5/8
OBZ 10-10-1/4	M10FBT1/4N	10MO-3TTF	10	1/4	67,0	33,5	22,4	25,9	13/16
OBZ 12-12-1/8	M12FBT1/8N	12MO-3TTF	12	1/8	72,0	36,0	22,3	25,9	13/16
OBZ 12-12-1/4	M12FBT1/4N	12MO-3-4TTF	12	1/4	72,0	36,0	22,3	25,9	13/16
OBZ 12-12-3/8	M12FBT3/8N	12MO-3TTF	12	3/8	72,0	36,0	22,4	25,9	13/16
OBZ 12-12-1/2	M12FBT1/2N	12MO-3-8TTF	12	1/2	77,6	38,8	28,5	28,7	1
OBZ 16-16-1/2	M16FBT1/2N	16MO-3TTF	16	1/2	77,6	38,8	28,4	28,7	1

NOTE: A and C dimensions are typical finger-tight.

Dimensions for reference only, subject to change.

Tube to Tube Unions

Union

For fractional tube

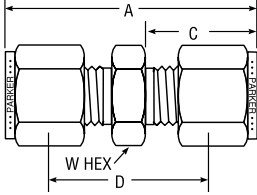
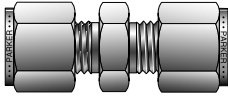

CPI™ PART NO.	A-LOK® PART NO.	INTER- CHANGES WITH	INCHES				
			TUBE O.D.	A	C	D	W HEX
1-1 HBZ	1SC1	100-6	1/16	0.99	0.43	0.69	5/16
2-2 HBZ	2SC2	200-6	1/8	1.39	0.60	0.88	7/16
3-3 HBZ	3SC3	300-6	3/16	1.48	0.64	0.95	7/16
4-4 HBZ	4SC4	400-6	1/4	1.62	0.70	1.03	1/2
5-5 HBZ	5SC5	500-6	5/16	1.70	0.73	1.11	9/16
6-6 HBZ	6SC6	600-6	3/8	1.77	0.76	1.17	5/8
8-8 HBZ	8SC8	810-6	1/2	2.02	0.87	1.22	13/16
10-10 HBZ	10SC10	1010-6	5/8	2.05	0.87	1.25	15/16
12-12 HBZ	12SC12	1210-6	3/4	2.11	0.87	1.31	1-1/16
14-14 HBZ	14SC14	1410-6	7/8	2.18	0.87	1.38	1-3/16
16-16 HBZ	16SC16	1610-6	1	2.57	1.05	1.59	1-3/8
20-20 HBZ	20SC20	2010-6	1-1/4	3.61	1.52	1.89	1-3/4
24-24 HBZ	24SC24	2410-6	1-1/2	4.23	1.77	2.11	2-1/8
32-32 HBZ	32SC32	3210-6	2	5.88	2.47	2.94	2-3/4

NOTE: A and C dimensions are typical finger-tight.

Dimensions for reference only, subject to change.

Union

For metric tube

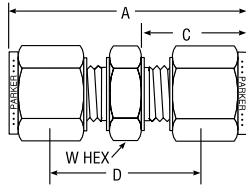
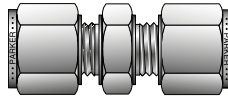

CPI™ PART NO.	A-LOK® PART NO.	INTER- CHANGES WITH	MILLIMETERS				
			TUBE O.D.	A	C	D	W HEX
HBZ 2-2	SCM2	2MO-6	2	35,6	15,3	22,4	12,0
HBZ 3-3	SCM3	3MO-6	3	35,3	15,3	22,1	12,0
HBZ 4-4	SCM4	4MO-4	4	37,4	16,1	24,2	12,0
HBZ 6-6	SCM6	6MO-6	6	41,2	17,7	26,2	14,0
HBZ 8-8	SCM8	8MO-6	8	43,2	18,6	28,2	15,0
HBZ 10-10	SCM10	10MO-6	10	46,2	19,5	31,0	18,0
HBZ 12-12	SCM12	12MO-6	12	51,2	22,0	31,0	22,0
HBZ 14-14	SCM14	14MO-6	14	52,0	22,0	31,8	24,0
HBZ 15-15	SCM15	15MO-6	15	52,0	22,0	31,8	24,0
HBZ 16-16	SCM16	16MO-6	16	52,0	22,0	31,8	24,0
HBZ 18-18	SCM18	18MO-6	18	53,5	22,0	33,3	27,0
HBZ 20-20	SCM20	20MO-6	20	55,0	22,0	34,8	30,0
HBZ 22-22	SCM22	22MO-6	22	55,0	22,0	34,8	30,0
HBZ 25-25	SCM25	25MO-6	25	65,1	26,5	40,5	35,0
	SCM28	28MO-6	28	85,0	38,0	49,0	41,0
	SCM30	30MO-6	30	92,8	42,0	53,0	46,0
	SCM32	32MO-6	32	97,3	44,0	55,3	46,0

NOTE: A and C dimensions are typical finger-tight.

Dimensions for reference only, subject to change.

Color Coding

For easy reference, table column headings are color indicated as follows:

fractional



metric



Tube to Tube Unions

Single/Double Ferrule
Instrument Compression
Fittings

Conversion Union

For metric tube

Metric Tube to Inch Tube

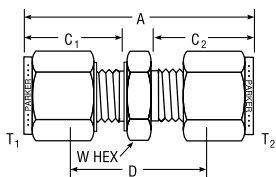
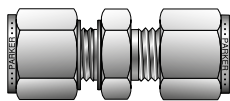

CPIT™ PART NO.	A-LOK® PART NO.	INTER- CHANGES WITH	TUBE O.D.		MILLIMETERS				
			T ₁ MM	T ₂ INCH	A	C ₁	C ₂	D	W HEX
HBZ 3-1/8	M3CU2	3MO-6-2	3	1/8	36,3	15,3	15,3	22,6	12,0
HBZ 4-1/8	M4CU2	4MO-6-2	4	1/8	36,5	16,1	15,3	23,6	12,0
HBZ 4-1/4	M4CU4	4MO-6-4	4	1/4	39,3	16,1	17,7	26,4	14,0
HBZ 6-1/8	M6CU2	6MO-6-2	6	1/8	38,5	17,7	15,3	24,6	14,0
HBZ 6-1/4	M6CU4	6MO-6-4	6	1/4	41,1	17,7	17,7	25,9	14,0
HBZ 6-5/16	M6CU5	6MO-6-5	6	5/16	42,3	17,7	18,8	27,2	14,0
HBZ 8-1/4	M8CU4	8MO-6-4	8	1/4	42,3	18,6	17,7	27,2	15,0
HBZ 8-3/8	M8CU6	8MO-6-6	8	3/8	44,0	18,6	19,3	29,1	15,0
HBZ 10-1/8	M10CU2	10MO-6-2	10	1/8	41,8	19,5	15,3	27,9	18,0
HBZ 10-1/4	M10CU4	10MO-6-4	10	1/4	44,5	19,5	17,7	29,2	18,0
HBZ 10-3/8	M10CU6	10MO-6-6	10	3/8	46,0	19,5	19,3	30,7	18,0
HBZ 12-3/8	M12CU6	12MO-6-6	12	3/8	48,4	22,0	19,3	30,7	22,0
HBZ 12-1/2	M12CU8	12MO-6-8	12	1/2	51,1	22,0	21,8	31,0	22,0
HBZ 15-1/2	M15CU8	15MO-6-8	15	1/2	52,0	22,0	21,8	32,0	24,0
HBZ 16-3/8	M16CU6	16MO-6-6	16	3/8	52,0	22,0	19,3	34,3	24,0
HBZ 18-3/4	M18CU12	18MO-6-12	18	3/4	53,5	22,0	21,8	33,5	27,0

NOTE: A, C₁ and C₂ dimensions are typical finger-tight.

Dimensions for reference only, subject to change.

Reducing Union

For fractional tube

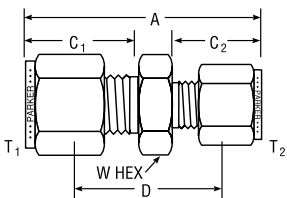
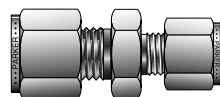

CPIT™ PART NO.	A-LOK® PART NO.	INTER- CHANGES WITH	INCHES						
			T ₁ TUBE O.D.	T ₂ TUBE O.D.	A	C ₁	C ₂	D	W HEX
2-1 HBZ	2RU1	200-6-1	1/8	1/16	1.21	0.60	.43	0.81	7/16
3-1 HBZ	3RU1	300-6-1	3/16	1/16	1.27	0.64	.43	0.86	7/16
3-2 HBZ	3RU2	300-6-2	3/16	1/8	1.44	0.64	.60	0.92	7/16
4-1 HBZ	4RU1	400-6-1	1/4	1/16	1.38	0.70	.43	0.91	1/2
4-2 HBZ	4RU2	400-6-2	1/4	1/8	1.52	0.70	.60	0.97	1/2
4-3 HBZ	4RU3	400-6-3	1/4	3/16	1.55	0.70	.64	1.00	1/2
5-2 HBZ	5RU2	500-6-2	5/16	1/8	1.58	0.73	.60	1.03	9/16
5-4 HBZ	5RU4	500-6-4	5/16	1/4	1.67	0.73	.70	1.08	9/16
6-1 HBZ	6RU1	600-6-1	3/8	1/16	1.44	0.76	.43	1.00	5/8
6-2 HBZ	6RU2	600-6-2	3/8	1/8	1.61	0.76	.60	1.06	5/8
6-4 HBZ	6RU4	600-6-4	3/8	1/4	1.71	0.76	.70	1.13	5/8
6-5 HBZ	6RU5	600-6-5	3/8	5/16	1.75	0.76	.73	1.16	5/8
8-2 HBZ	8RU2	810-6-2	1/2	1/8	1.75	0.87	.60	1.09	13/16
8-4 HBZ	8RU4	810-6-4	1/2	1/4	1.85	0.87	.70	1.16	13/16
8-6 HBZ	8RU6	810-6-6	1/2	3/8	1.91	0.87	.76	1.22	13/16
10-6 HBZ	10RU6	1010-6-6	5/8	3/8	1.94	0.87	.76	1.25	15/16
10-8 HBZ	10RU8	1010-6-8	5/8	1/2	2.05	0.87	.87	1.25	15/16
12-4 HBZ	12RU4	1210-6-4	3/4	1/4	1.95	0.87	.76	1.25	1-1/16
12-6 HBZ	12RU6	1210-6-6	3/4	3/8	2.00	0.87	.76	1.31	1-1/16
12-8 HBZ	12RU8	1210-6-8	3/4	1/2	2.11	0.87	.87	1.31	1-1/16
12-10 HBZ	12RU10	1210-6-10	3/4	5/8	2.11	0.87	.87	1.31	1-1/16
16-8 HBZ	16RU8	1610-6-8	1	1/2	2.39	1.05	.87	1.50	1-3/8
16-12 HBZ	16RU12	1610-6-12	1	3/4	2.39	1.05	.87	1.50	1-3/8

NOTE: A, C₁ and C₂ dimensions are typical finger-tight.

Dimensions for reference only, subject to change.

Reducing Union

For metric tube

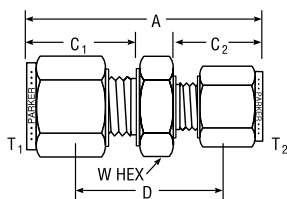
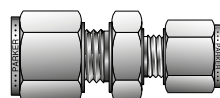

CPIT™ PART NO.	A-LOK® PART NO.	INTER- CHANGES WITH	MILLIMETERS						
			T ₁ TUBE O.D.	T ₂ TUBE O.D.	A	C ₁	C ₂	D	W HEX
HBZ 3-2	M3RUM2	3MO-6-2M	3	2	35,8	15,3	15,3	22,6	12,0
HBZ 6-2	M6RUM2	6MO-6-2M	6	2	38,7	17,7	15,3	24,6	14,0
HBZ 6-3	M6RUM3	6MO-6-3M	6	3	38,7	17,7	15,3	24,6	14,0
HBZ 6-4	M6RUM4	6MO-6-4M	6	4	39,5	17,7	16,1	25,4	14,0
HBZ 8-6	M8RUM6	8MO-6-6M	8	6	42,4	18,6	17,7	27,4	15,0
HBZ 10-6	M10RUM6	10MO-6-6M	10	6	44,5	19,5	17,7	29,4	18,0
HBZ 10-8	M10RUM8	10MO-6-8M	10	8	44,5	19,5	18,6	29,4	18,0
HBZ 12-6	M12RUM6	12MO-6-6M	12	6	47,0	22,0	17,7	29,4	22,0
HBZ 12-8	M12RUM8	12MO-6-8M	12	8	47,8	22,0	18,6	30,2	22,0
HBZ 12-10	M12RUM10	12MO-6-10M	12	10	48,7	22,0	19,5	31,0	22,0
HBZ 16-10	M16RUM10	16MO-6-10M	16	10	49,5	22,0	19,5	31,8	24,0
HBZ 16-12	M16RUM12	16MO-6-12M	16	12	52,0	22,0	22,0	31,8	24,0
HBZ 18-12	M18RUM12	18MO-6-12M	18	12	53,5	22,0	22,0	33,3	27,0
HBZ 25-18	M25RUM18	25MO-6-18M	25	18	60,5	26,5	22,0	38,1	35,0
HBZ 25-20	M25RUM20	25MO-6-20M	25	20	62,3	26,5	22,0	39,9	35,0

NOTE: A, C₁ and C₂ dimensions are typical finger-tight.

Dimensions for reference only, subject to change.

Tube to Tube Unions

Bulkhead Union For fractional tube

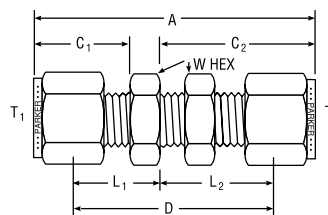
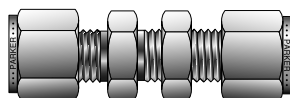

CPI™ PART NO.	A-LOK® PART NO.	INTER- CHANGES WITH	INCHES									
			TUBE O.D.	A	C ₁	C ₂	D	L ₁	L ₂	W HEX	BULKHEAD HOLE DRILL SIZE	MAXIMUM BULKHEAD THICKNESS
1-1 WBZ	1BC1	100-61	1/16	1.23	.43	0.68	0.94	.28	0.53	5/16	13/64	1/8
2-2 WBZ	2BC2	200-61	1/8	2.02	.60	1.23	1.50	.34	0.97	1/2	21/64	1/2
2-4 WBZ	2BC4	400-61-2	1/8 - 1/4	2.17	.60	1.62	1.31	.34	1.02	5/8	29/64	17/32
3-3 WBZ	3BC3	300-61	3/16	2.11	.64	1.26	1.59	.38	1.00	9/16	25/64	1/2
4-2 WBZ	4BC2	200-61-4	1/4 - 1/8	2.18	.70	1.23	1.62	.41	0.97	1/2	21/64	1/2
4-4 WBZ	4BC4	400-61	1/4	2.27	.70	1.31	1.69	.41	1.02	5/8	29/64	17/32
5-5 WBZ	5BC5	500-61	5/16	2.40	.73	1.42	1.81	.44	1.12	11/16	33/64	9/16
6-6 WBZ	6BC6	600-61	3/8	2.46	.76	1.44	1.88	.47	1.16	3/4	37/64	9/16
8-8 WBZ	8BC8	810-61	1/2	2.80	.87	1.65	2.00	.47	1.25	15/16	49/64	19/32
10-10 WBZ	10BC10	1010-61	5/8	2.86	.87	1.68	2.06	.47	1.28	1-1/16	57/64	19/32
12-12 WBZ	12BC12	1210-61	3/4	3.11	.87	1.87	2.31	.47	1.47	1-3/16	1-1/64	25/32
14-14 WBZ	14BC14	1410-61	7/8	3.33	.87	2.09	2.53	.47	1.69	1-3/8	1-9/64	15/16
16-16 WBZ	16BC16	1610-61	1	3.78	1.05	2.27	2.81	.56	1.78	1-5/8	1-21/64	15/16

NOTE: For reducer sizes call out short end first.

Dimensions for reference only, subject to change.

A, C₁ and C₂ dimensions are typical finger-tight.
For replacement bulkhead nuts, see page 106, Part WLZ.

Bulkhead Union For metric tube

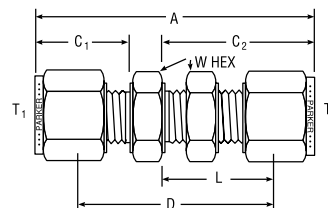
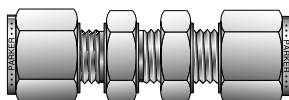

CPI™ PART NO.	A-LOK® PART NO.	INTER- CHANGES WITH	MILLIMETERS									
			TUBE O.D.	A	C ₁	C ₂	D	L	W HEX	B'HEAD HOLE DRILL SIZE	MAX. B'HEAD THICK.	
WBZ 3-3	BCM3	3MO-61	3	51,3	15,3	31,2	38,2	24,6	14,0	8,3	12,7	
WBZ 4-4	BCM4	4MO-61	4	53,7	16,1	32,0	40,5	25,4	14,0	9,9	12,7	
WBZ 6-6	BCM6	6MO-61	6	57,9	17,7	33,7	42,9	26,2	16,0	11,5	10,2	
WBZ 8-8	BCM8	8MO-61	8	61,0	18,6	36,0	46,0	28,5	18,0	13,1	11,2	
WBZ 10-10	BCM10	10MO-61	10	63,6	19,5	37,0	48,4	29,4	22,0	16,3	11,2	
WBZ 12-12	BCM12	12MO-61	12	71,0	22,0	41,9	50,8	31,8	24,0	19,5	12,7	
WBZ 15-15	BCM15	15MO-61	15	72,5	22,0	42,6	52,3	32,5	27,0	22,5	12,7	
WBZ 16-16	BCM16	16MO-61	16	72,6	22,0	42,6	52,4	32,5	27,0	22,5	12,7	
WBZ 18-18	BCM18	18MO-61	18	78,9	22,0	47,4	58,7	37,3	30,0	26,0	16,8	
WBZ 20-20	BCM20	20MO-61	20	88,2	22,0	51,0	68,0	40,9	35,0	29,0	19,0	
WBZ 25-25	BCM25	25MO-61	25	95,8	26,5	54,4	71,4	42,2	41,0	33,8	24,0	

NOTE: A, C₁ and C₂ dimensions are typical finger-tight.

Dimensions for reference only, subject to change.

For replacement bulkhead nuts, see page 106, Part BN.
For reducer sizes call out short end first.

Color Coding

For easy reference, table column headings are color indicated as follows:

fractional



metric



Tube to Tube Unions

Single/Double Ferrule
Instrument Compression
Fittings

Dielectric Union Adapter

For fractional tube

includes nuts, machined tube with molded PEEK¹⁾ insulator, preset ferrule, and dielectric identification ring

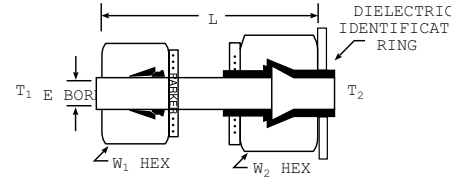
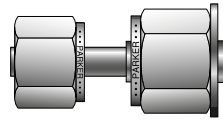

CPI™ ADAPTER PART NO.	A-LOK® ADAPTER PART NO.	INCHES							PRESSURE RATING @ 70°F LIQUID / GAS (PSI)
		T ₁ TUBE END	T ₂ TUBE END	L	E BORE	W1 HEX	W2 HEX		
6-8 DEBTA-SS	6-8 DELTA	3/8	1/2	2.08	.30	11/16	7/8	4000 / 3000	
8-10 DEBTA-SS	N/A	1/2	5/8	2.58	.38	7/8	1	3000 / 2000	

*Other end connectors available upon request.

Dimensions for reference only, subject to change.

1) Polyetherether Ketone

NOTE: Makeup instructions included with parts in box when ordered as an Adapter only.

Dielectric Resistivity 10x10⁹ OHMS @ 500 volts DC (Tested on Mil-STD-202F)

Dielectric withstanding voltage less than 100 microamps leakage @ 1500 volts AC

AMBIENT TEMPERATURE, °F	-40	-20	0	20	40	60	80	100	120	140	160	180	200
TEMPERATURE DERATING FACTOR	1.00	1.00	1.00	1.00	1.00	1.00	1.00	0.93	0.86	0.79	0.72	0.64	0.56

Dielectric Assembly

For fractional tube

includes dielectric union adapter with assembled tube fitting unions

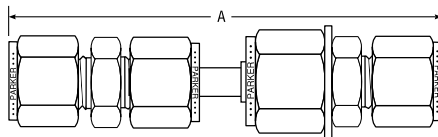
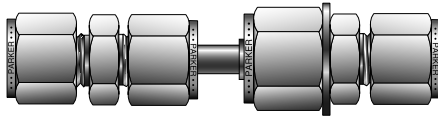

CPI™ ASSEMBLY PART NO.	A-LOK® ASSEMBLY PART NO.	INCHES	END ADAPTORS
*COMPRESSION	*COMPRESSION	A†	
4H DEBTA	4H DELTA	4.08	6RU4/8RU4
6H DEBTA	6H DELTA	4.20	6SC6/8RU6
8H DEBTA	8H DELTA	4.79	8SC8/10RU8

FEMALE PIPE	FEMALE PIPE	A	END ADAPTORS
4G DEBTA	4G DELTA	3.59	6FSC4N/8FSC4N
6G DEBTA	6G DELTA	3.71	6FSC6N/8FSC6N
8G DEBTA	8G DELTA	4.40	8FSC8N/10FSC8N

MALE PIPE	MALE PIPE	A	END ADAPTORS
4F DEBTA	4F DELTA	3.80	6MSC4N/8MSC4N
6F DEBTA	6F DELTA	3.80	6MSC6N/8MSC6N
8F DEBTA	8F DELTA	4.58	8MSC8N/10MSC8N

†Finger tight assembly dimensions.

Dimensions for reference only, subject to change.

Union Elbow

For fractional tube

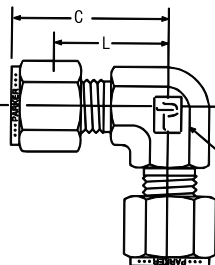
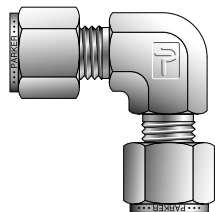

CPI™ PART NO.	A-LOK® PART NO.	INTER-CHANGES WITH	INCHES			
			TUBE O.D.	C	L	W HEX
1-1 EBZ	1EE1	100-9	1/16	.70	.55	3/8
2-2 EBZ	2EE2	200-9	1/8	.88	.62	3/8
3-3 EBZ	3EE3	300-9	3/16	1.00	.74	1/2
4-4 EBZ	4EE4	400-9	1/4	1.06	.77	1/2
5-5 EBZ	5EE5	500-9	5/16	1.13	.84	9/16
6-6 EBZ	6EE6	600-9	3/8	1.20	.91	5/8
8-8 EBZ	8EE8	810-9	1/2	1.42	1.02	13/16
10-10 EBZ	10EE10	1010-9	5/8	1.50	1.10	15/16
12-12 EBZ	12EE12	1210-9	3/4	1.57	1.17	1-1/16
14-14 EBZ	14EE14	1410-9	7/8	1.76	1.36	1-3/8
16-16 EBZ	16EE16	1610-9	1	1.93	1.45	1-3/8
20-20 EBZ	20EE20	2010-9	1-1/4	2.61	1.75	1-5/8
24-24 EBZ	24EE24	2410-9	1-1/2	3.06	2.00	1-7/8
32-32 EBZ	32EE32	3210-9	2	4.22	2.75	2-13/16

NOTE: C dimension is typical finger-tight.

Dimensions for reference only, subject to change.

Sizes 20, 24, 32 require additional lubrication prior to assembly.

Tube to Tube Unions

Union Elbow For metric tube

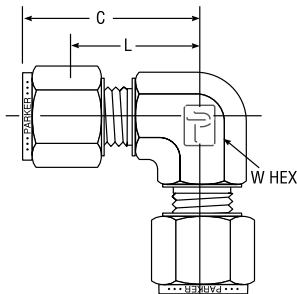
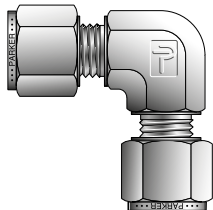

CPI™ PART NO.	A-LOK® PART NO.	INTER- CHANGES WITH	MILLIMETERS			IN/MM
			TUBE O.D.	C	L	W HEX
EBZ 3-3	EEM3	3MO-9	3	22,3	15,7	3/8
EBZ 4-4	EEM4	4MO-9	4	25,4	18,8	1/2
EBZ 6-6	EEM6	6MO-9	6	27,0	19,6	1/2
EBZ 8-8	EEM8	8MO-9	8	28,8	21,3	9/16
EBZ 10-10	EEM10	10MO-9	10	31,5	23,9	11/16
EBZ 12-12	EEM12	12MO-9	12	36,0	25,9	13/16
EBZ 14-14	EEM14	14MO-9	14	38,1	28,0	15/16
EBZ 15-15	EEM15	15MO-9	15	38,0	27,9	15/16
EBZ 16-16	EEM16	16MO-9	16	38,0	27,9	15/16
EBZ 18-18	EEM18	18MO-9	18	39,8	29,7	1-1/16
EBZ 20-20	EEM20	20MO-9	20	44,6	34,5	1-3/8
EBZ 22-22	EEM22	22MO-9	22	44,6	34,5	1-3/8
EBZ 25-25	EEM25	25MO-9	25	49,1	36,8	1-3/8
	EEM28	28MO-6	28	64,0	45,7	41 mm
	EEM30	30MO-6	30	70,0	50,1	48 mm
	EEM32	32MO-6	32	72,4	51,3	48 mm

NOTE: C dimension is typical finger-tight.

Dimensions for reference only, subject to change.

Drop Size Elbows For fractional tube

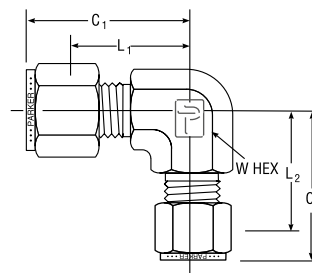
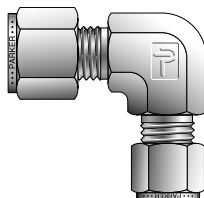

CPI™ PART NO.	A-LOK® PART NO.	INTER- CHANGES WITH	INCHES					W HEX
			TUBE O.D.	L ₁	C ₁	L ₂	C ₂	
3-2 EBZ	3-2 ELZ	300-9-2	3/16-1/8	0.74	1.01	0.70	0.96	1/2
4-2 EBZ	4-2 ELZ	400-9-2	1/4-1/8	0.77	1.06	0.70	0.96	1/2
5-2 EBZ	5-2 ELZ	500-9-2	5/16-1/8	0.88	1.17	0.78	1.04	5/8
5-4 EBZ	5-4 ELZ	500-9-4	5/16-1/4	0.88	1.17	0.85	1.14	5/8
6-2 EBZ	6-2 ELZ	600-9-2	3/8-1/8	0.91	1.20	0.78	1.04	5/8
6-4 EBZ	6-4 ELZ	600-9-4	3/8-1/4	0.91	1.20	0.85	1.17	5/8
6-5 EBZ	6-5 ELZ	600-9-5	3/8-5/16	0.91	1.20	0.88	1.17	5/8
8-4 EBZ	8-4 ELZ	810-9-4	1/2-1/4	1.02	1.42	0.96	1.25	13/16
8-5 EBZ	8-5 ELZ	810-9-5	1/2-5/16	1.02	1.42	0.99	1.28	13/16
8-6 EBZ	8-6 ELZ	810-9-6	1/2-3/8	1.02	1.42	1.02	1.31	13/16
10-6 EBZ	10-6 ELZ	1010-9-6	5/8-3/8	1.10	1.50	1.10	1.39	15/16
10-8 EBZ	10-8 ELZ	1010-9-8	5/8-1/2	1.10	1.50	1.10	1.50	15/16
12-4 EBZ	12-4 ELZ	1210-9-4	3/4-1/4	1.16	1.56	1.10	1.39	1-1/16
12-6 EBZ	12-6 ELZ	1210-9-6	3/4-3/8	1.16	1.56	1.16	1.45	1-1/16
12-8 EBZ	12-8 ELZ	1210-9-8	3/4-1/2	1.16	1.56	1.16	1.56	1-1/16
14-4 EBZ	14-4 ELZ	1410-9-4	7/8-1/4	1.36	1.76	1.30	1.59	1-3/8
16-8 EBZ	16-8 ELZ	1610-9-8	1-1/2	1.45	1.94	1.36	1.76	1-3/8
16-12 EBZ	16-12 ELZ	1610-9-12	1-3/4	1.45	1.94	1.36	1.76	1-3/8

NOTE: C dimension is typical finger-tight.

Dimensions for reference only, subject to change.

Color Coding

For easy reference, table column headings are color indicated as follows:

fractional

metric

Tube to Tube Unions

Union Tee For fractional tube

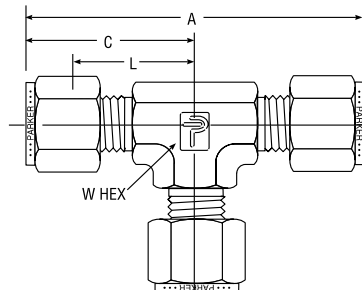
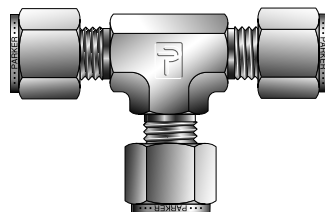

Single/Double Ferrule
Instrument Compression
Fittings

CPI™ PART NO.	A-LOK® PART NO.	INTER- CHANGES WITH	INCHES				
			TUBE O.D.	A	C	L	W HEX
1-1-1 JBZ	1ET1	100-3	1/16	1.42	0.71	0.56	3/8
2-2-2 JBZ	2ET2	200-3	1/8	1.76	0.88	0.62	3/8
3-3-3 JBZ	3ET3	300-3	3/16	1.96	0.96	0.70	7/16
4-4-4 JBZ	4ET4	400-3	1/4	2.12	1.06	0.77	1/2
5-5-5 JBZ	5ET5	500-3	5/16	2.34	1.17	0.88	5/8
6-6-6 JBZ	6ET6	600-3	3/8	2.40	1.20	0.91	5/8
8-8-8 JBZ	8ET8	810-3	1/2	2.84	1.42	1.02	13/16
10-10-10 JBZ	10ET10	1010-3	5/8	3.06	1.53	1.13	1
12-12-12 JBZ	12ET12	1210-3	3/4	3.14	1.57	1.16	1-1/16
14-14-14 JBZ	14ET14	1410-3	7/8	3.52	1.76	1.36	1-3/8
16-16-16 JBZ	16ET16	1610-3	1	3.86	1.93	1.45	1-3/8
20-20-20 JBZ	20ET20	2010-3	1-1/4	5.22	2.61	1.75	1-5/8
24-24-24 JBZ	24ET24	2410-3	1-1/2	6.12	3.06	2.00	1-7/8
32-32-32 JBZ	32ET32	3210-3	2	8.44	4.22	2.75	2-13/16

NOTE: A and C dimensions are typical finger-tight.

Dimensions for reference only, subject to change.

Sizes 20, 24, 32 require additional lubrication prior to assembly.

Union Tee For metric tube

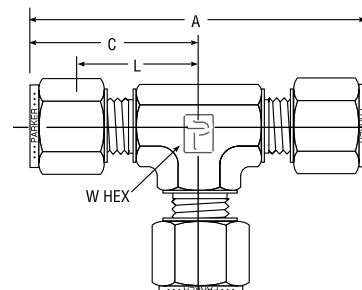
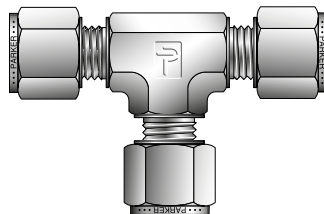

CPI™ PART NO.	A-LOK® PART NO.	INTER- CHANGES WITH	MILLIMETERS				IN/MM
			TUBE O.D.	A	C	L	W HEX
JBZ 2-2-2	ETM2	2MO-3	2	44,7	22,3	15,7	3/8
JBZ 3-3-3	ETM3	3MO-3	3	44,7	22,3	15,7	3/8
JBZ 4-4-4	ETM4	4MO-3	4	50,8	25,4	18,8	1/2
JBZ 6-6-6	ETM6	6MO-3	6	53,9	27,0	19,6	1/2
JBZ 8-8-8	ETM8	8MO-3	8	59,7	29,9	22,4	5/8
JBZ 10-10-10	ETM10	10MO-3	10	63,0	31,5	23,9	11/16
JBZ 12-12-12	ETM12	12MO-3	12	72,0	36,0	25,9	13/16
JBZ 14-14-14	ETM14	14MO-3	14	77,6	38,8	28,7	1
JBZ 15-15-15	ETM15	15MO-3	15	77,6	38,8	28,7	1
JBZ 16-16-16	ETM16	16MO-3	16	77,6	38,8	28,7	1
JBZ 18-18-18	ETM18	18MO-3	18	79,5	38,8	29,7	1-1/16
JBZ 20-20-20	ETM20	20MO-3	20	89,3	44,6	34,5	1-3/8
JBZ 22-22-22	ETM22	22MO-3	22	89,3	44,6	34,5	1-3/8
JBZ 25-25-25	ETM25	25MO-3	25	98,3	49,1	36,8	1-3/8
	ETM28	28MO-3	28	128,0	64,0	45,7	41 mm
	ETM30	30MO-3	30	140,0	70,0	50,1	48 mm
	ETM32	32MO-3	32	145	72,3	51,3	48 mm

NOTE: A and C dimensions are typical finger-tight.

Dimensions for reference only, subject to change.

Tube to Tube Unions

Drop Size Tees

For fractional tube

Eliminates the extra connection when adapting with a tube stub reducer

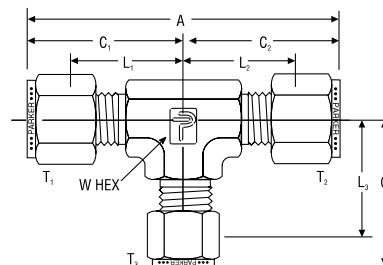
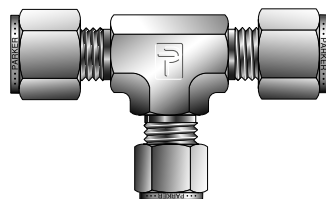

Single/Double Ferrule
Instrument Compression
Fittings

CPI™ PART NO.	A-LOK® PART NO.	INTER- CHANGES WITH	INCHES										
			T ₁ TUBE O.D.	T ₂ TUBE O.D.	T ₃ TUBE O.D.	A	L ₁	C ₁	L ₂	C ₂	L ₃	C ₃	W HEX
4-4-2 JBZ	4-4-2 JLZ	400-3-4-2	1/4	1/4	1/8	2.10	0.76	1.05	0.76	1.05	0.70	0.96	1/2
6-6-4 JBZ	6-6-4 JLZ	600-3-6-4	3/8	3/8	1/4	2.40	0.91	1.20	0.91	1.20	0.85	1.14	5/8
6-4-6 JBZ	6-4-6 JLZ	600-3-4-6	3/8	1/4	3/8	2.34	0.91	1.20	0.85	1.14	0.91	1.20	5/8
6-4-4 JBZ	6-4-4 JLZ	600-3-4-4	3/8	1/4	1/4	2.34	0.91	1.20	0.85	1.14	0.85	1.14	5/8
8-8-6 JBZ	8-8-6 JLZ	810-3-8-6	1/2	1/2	3/8	2.84	1.02	1.42	1.02	1.42	1.02	1.31	13/16
8-8-4 JBZ	8-8-4 JLZ	810-3-8-4	1/2	1/2	1/4	2.84	1.02	1.42	1.02	1.42	0.96	1.25	13/16
8-6-8 JBZ	8-6-8 JLZ	810-3-6-8	1/2	3/8	1/2	2.73	1.02	1.42	1.02	1.31	1.02	1.42	13/16
8-4-8 JBZ	8-4-8 JLZ	810-3-4-8	1/2	1/4	1/2	2.67	1.02	1.42	0.96	1.25	1.02	1.42	13/16
8-6-6 JBZ	8-6-6 JLZ	810-3-6-6	1/2	3/8	3/8	2.73	1.02	1.42	1.02	1.31	1.02	1.31	13/16
8-4-4 JBZ	8-4-4 JLZ	810-3-4-4	1/2	1/4	1/4	2.67	1.02	1.42	.96	1.25	.96	1.25	13/16
10-10-8 JBZ	10-10-8 JLZ	1010-3-10-8	5/8	5/8	1/2	3.06	1.13	1.53	1.13	1.53	1.13	1.53	7/8
10-10-6 JBZ	10-10-6 JLZ	1010-3-10-6	5/8	5/8	3/8	3.06	1.13	1.53	1.13	1.53	1.13	1.53	7/8
10-8-8 JBZ	10-8-8 JLZ	1010-3-8-8	5/8	1/2	1/2	3.06	1.13	1.53	1.13	1.53	1.13	1.53	7/8
10-8-6 JBZ	10-8-6 JLZ	1010-3-8-6	5/8	1/2	3/8	3.06	1.13	1.53	1.13	1.53	1.13	1.42	7/8
10-6-6 JBZ	10-6-6 JLZ	1010-3-6-6	5/8	3/8	3/8	2.95	1.13	1.53	1.13	1.42	1.13	1.42	7/8
10-6-8 JBZ	10-6-8 JLZ	1010-3-6-8	5/8	3/8	1/2	2.95	1.13	1.53	1.13	1.42	1.13	1.53	7/8
12-12-10 JBZ	12-12-10 JLZ	1210-3-12-10	3/4	3/4	5/8	3.12	1.16	1.56	1.16	1.56	1.16	1.56	1-1/16
12-12-8 JBZ	12-12-8 JLZ	1210-3-12-8	3/4	3/4	1/2	3.12	1.16	1.56	1.16	1.56	1.16	1.56	1-1/16
12-12-6 JBZ	12-12-6 JLZ	1210-3-12-6	3/4	3/4	3/8	3.12	1.16	1.56	1.16	1.56	1.16	1.45	1-1/16
12-12-4 JBZ	12-12-4 JLZ	1210-3-12-4	3/4	3/4	1/4	3.12	1.16	1.56	1.16	1.56	1.10	1.39	1-1/16
12-10-10 JBZ	12-10-10 JLZ	1210-3-10-10	3/4	5/8	5/8	3.12	1.16	1.56	1.16	1.56	1.16	1.56	1-1/16
12-8-8 JBZ	12-8-8 JLZ	1210-3-8-8	3/4	1/2	1/2	3.12	1.16	1.56	1.16	1.56	1.16	1.56	1-1/16
12-6-6 JBZ	12-6-6 JLZ	1210-3-6-6	3/4	3/8	3/8	3.01	1.16	1.56	1.16	1.45	1.16	1.45	1-1/16
12-10-8 JBZ	12-10-8 JLZ	1210-3-10-8	3/4	5/8	1/2	3.12	1.16	1.56	1.16	1.56	1.16	1.56	1-1/16
12-10-6 JBZ	12-10-6 JLZ	1210-3-10-6	3/4	5/8	3/8	3.12	1.16	1.56	1.16	1.56	1.16	1.45	1-1/16
12-8-6 JBZ	12-8-6 JLZ	1210-3-8-6	3/4	1/2	3/8	3.12	1.16	1.56	1.16	1.56	1.16	1.45	1-1/16
14-14-6 JBZ	14-14-6 JLZ	1410-3-14-6	7/8	7/8	3/8	3.52	1.36	1.76	1.36	1.76	1.36	1.65	1-3/8
14-14-4 JBZ	14-14-4 JLZ	1410-3-14-4	7/8	7/8	1/4	3.52	1.36	1.76	1.36	1.76	1.30	1.59	1-3/8
14-12-12 JBZ	14-12-12 JLZ	1410-3-12-12	7/8	3/4	3/4	3.52	1.36	1.76	1.36	1.76	1.36	1.76	1-3/8
14-12-8 JBZ	14-12-8 JLZ	1410-3-12-8	7/8	3/4	1/2	3.52	1.36	1.76	1.36	1.76	1.36	1.76	1-3/8
14-12-6 JBZ	14-12-6 JLZ	1410-3-12-6	7/8	3/4	3/8	3.52	1.36	1.76	1.36	1.76	1.36	1.65	1-3/8
14-10-6 JBZ	14-10-6 JLZ	1410-3-10-6	7/8	5/8	3/8	3.52	1.36	1.76	1.36	1.76	1.36	1.65	1-3/8
14-8-12 JBZ	14-8-12 JLZ	1410-3-8-12	7/8	1/2	3/4	3.52	1.36	1.76	1.36	1.76	1.36	1.76	1-3/8
16-16-12 JBZ	16-16-12 JLZ	1610-3-16-12	1	1	3/4	3.88	1.45	1.94	1.45	1.94	1.36	1.76	1-3/8
16-16-10 JBZ	16-16-10 JLZ	1610-3-16-10	1	1	5/8	3.88	1.45	1.94	1.45	1.94	1.36	1.76	1-3/8
16-16-8 JBZ	16-16-8 JLZ	1610-3-16-8	1	1	1/2	3.88	1.45	1.94	1.45	1.94	1.36	1.76	1-3/8
16-16-6 JBZ	16-16-6 JLZ	1610-3-16-6	1	1	3/8	3.88	1.45	1.94	1.45	1.94	1.36	1.65	1-3/8
16-16-4 JBZ	16-16-4 JLZ	1610-3-16-4	1	1	1/4	3.88	1.45	1.94	1.45	1.94	1.30	1.59	1-3/8
16-12-16 JBZ	16-12-16 JLZ	1610-3-12-16	1	3/4	1	3.70	1.45	1.94	1.36	1.76	1.45	1.94	1-3/8
16-14-14 JBZ	16-14-14 JLZ	1610-3-14-14	1	7/8	7/8	3.70	1.45	1.94	1.36	1.76	1.36	1.76	1-3/8
16-14-12 JBZ	16-14-12 JLZ	1610-3-14-12	1	7/8	3/4	3.70	1.45	1.94	1.36	1.76	1.36	1.76	1-3/8
16-14-8 JBZ	16-14-8 JLZ	1610-3-14-8	1	7/8	1/2	3.70	1.45	1.94	1.36	1.76	1.36	1.76	1-3/8
16-14-6 JBZ	16-14-6 JLZ	1610-3-14-6	1	7/8	3/8	3.70	1.45	1.94	1.36	1.76	1.36	1.65	1-3/8
16-14-4 JBZ	16-14-4 JLZ	1610-3-14-4	1	7/8	1/4	3.70	1.45	1.94	1.36	1.76	1.30	1.59	1-3/8
16-16-14 JBZ	16-16-14 JLZ	1610-3-16-14	1	1	7/8	3.88	1.45	1.94	1.45	1.94	1.36	1.76	1-3/8
16-12-10 JBZ	16-12-10 JLZ	1610-3-12-10	1	3/4	5/8	3.70	1.45	1.94	1.36	1.76	1.36	1.76	1-3/8
16-12-8 JBZ	16-12-8 JLZ	1610-3-12-8	1	3/4	1/2	3.70	1.45	1.94	1.36	1.76	1.36	1.76	1-3/8
16-10-6 JBZ	16-10-6 JLZ	1610-3-10-6	1	5/8	3/8	3.70	1.45	1.94	1.36	1.76	1.36	1.65	1-3/8
16-8-16 JBZ	16-8-16 JLZ	1610-3-8-16	1	1/2	1	3.70	1.45	1.94	1.36	1.76	1.45	1.94	1-3/8
16-8-8 JBZ	16-8-8 JLZ	1610-3-8-8	1	1/2	1/2	3.70	1.45	1.94	1.36	1.76	1.36	1.76	1-3/8
16-8-6 JBZ	16-8-6 JLZ	1610-3-8-6	1	1/2	3/8	3.70	1.45	1.94	1.36	1.76	1.36	1.65	1-3/8
16-8-4 JBZ	16-8-4 JLZ	1610-3-8-4	1	1/2	1/4	3.70	1.45	1.94	1.36	1.76	1.30	1.59	1-3/8
16-6-6 JBZ	16-6-6 JLZ	1610-3-6-6	1	3/8	3/8	3.59	1.45	1.94	1.36	1.65	1.36	1.65	1-3/8

NOTE: C dimensions are typical finger-tight.

Dimensions for reference only, subject to change.

Tube to Tube Unions

Union Cross For fractional tube

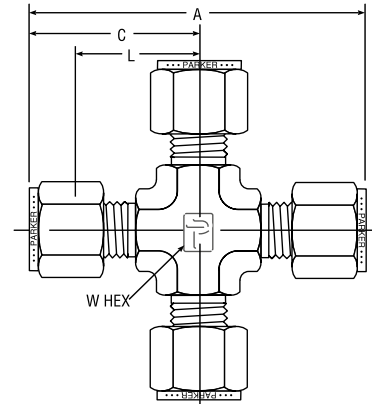
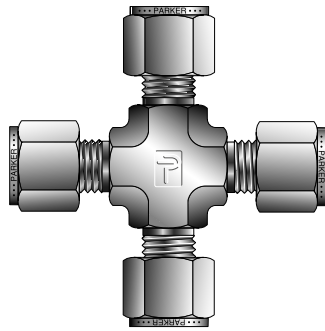

CPI™ PART NO.	A-LOK® PART NO.	INTER- CHANGES WITH	INCHES				
			TUBE O.D.	A	C	L	W HEX
2 KBZ	2ECR2	200-4	1/8	1.76	0.98	0.62	7/16
3 KBZ	3ECR3	300-4	3/16	1.83	0.96	0.70	7/16
4 KBZ	4ECR4	400-4	1/4	2.12	1.06	0.76	1/2
5 KBZ	5ECR5	500-4	5/16	2.34	1.17	0.88	5/8
6 KBZ	6ECR6	600-4	3/8	2.40	1.20	0.91	5/8
8 KBZ	8ECR8	810-4	1/2	2.84	1.42	1.02	13/16
10 KBZ	10ECR10	1010-4	5/8	3.06	1.53	1.13	1-1/16
12 KBZ	12ECR12	1210-4	3/4	3.12	1.57	1.16	1-1/16
14 KBZ	14ECR14	1410-4	7/8	3.52	1.76	1.36	1-5/16
16 KBZ	16ECR16	1610-4	1	3.86	1.93	1.45	1-5/16

NOTE: A and C dimensions are typical finger-tight.

Dimensions for reference only, subject to change.

Union Cross For metric tube

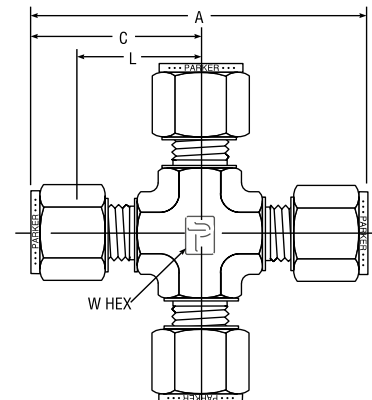
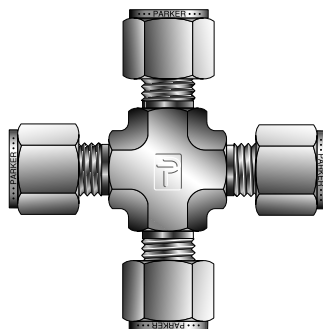

CPI™ PART NO.	A-LOK® PART NO.	INTER- CHANGES WITH	MILLIMETERS				INCHES
			TUBE O.D.	A	C	L	W HEX
KBZ 3	ECRM3	3MO-4	3	44,7	22,3	15,7	7/16
KBZ 4	ECRM4	4MO-4	4	50,8	25,4	18,8	1/2
KBZ 6	ECRM6	6MO-4	6	53,9	27,0	19,6	1/2
KBZ 8	ECRM8	8MO-4	8	59,7	29,9	22,4	5/8
KBZ 10	ECRM10	10MO-4	10	67,0	33,5	25,9	13/16
KBZ 12	ECRM12	12MO-4	12	72,0	36,0	25,9	13/16
KBZ 16	ECRM16	16MO-4	16	74,0	37,0	26,9	15/16
KBZ 18	ECRM18	18MO-4	18	76,6	38,3	28,2	1-1/16

NOTE: A and C dimensions are typical finger-tight.

Dimensions for reference only, subject to change.

Color Coding

For easy reference, table column headings are color indicated as follows:

fractional



metric



Port Connectors

Tube End Reducer For fractional tube

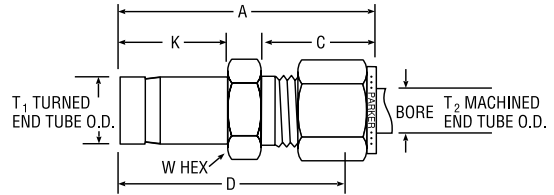
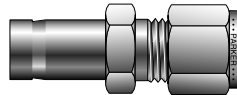

Single/Double Ferrule
Instrument Compression
Fittings

CPI™ PART NO.	A-LOK® PART NO.	INTER- CHANGES WITH	INCHES							
			T ₁ TURNED END TUBE O.D.	T ₂ MACHINED END TUBE O.D.	A	C	D	K	W HEX	BORE
2-1 TRBZ	2TUR1	100-R-2	1/8	1/16	1.10	0.43	0.95	0.53	5/16	0.05
3-1 TRBZ	3TUR1	100-R-3	3/16	1/16	1.13	0.43	0.98	0.58	5/16	0.05
4-1 TRBZ	4TUR1	100-R-4	1/4	1/16	1.24	0.43	1.09	0.63	7/16	0.05
1-2 TRBZ	1TUR2	200-R-1	1/16	1/8	1.18	0.60	0.92	0.38	7/16	0.09
2-2 TRBZ	2TUR2	200-R-2	1/8	1/8	1.34	0.43	1.09	0.54	7/16	0.07
3-2 TRBZ	3TUR2	200-R-3	3/16	1/8	1.35	0.60	1.09	0.58	7/16	0.09
4-2 TRBZ	4TUR2	200-R-4	1/4	1/8	1.42	0.60	1.16	0.63	7/16	0.09
6-2 TRBZ	6TUR2	200-R-6	3/8	1/8	1.48	0.60	1.22	0.69	7/16	0.09
8-2 TRBZ	8TUR2	200-R-8	1/2	1/8	1.74	0.60	1.48	0.91	9/16	0.09
2-3 TRBZ	2TUR3	300-R-2	1/8	3/16	1.37	0.63	1.11	0.53	7/16	0.08
4-3 TRBZ	4TUR3	300-R-4	1/4	3/16	1.46	0.63	1.20	0.63	7/16	0.13
2-4 TRBZ	2TUR4	400-R-2	1/8	1/4	1.45	0.70	1.16	0.53	1/2	0.08
3-4 TRBZ	3TUR4	400-R-3	3/16	1/4	1.48	0.60	1.19	0.56	1/2	0.12
4-4 TRBZ	4TUR4	400-R-4	1/4	1/4	1.54	0.70	1.25	0.63	1/2	0.16
5-4 TRBZ	5TUR4	400-R-5	5/16	1/4	1.57	0.70	1.28	0.66	1/2	0.16
6-4 TRBZ	6TUR4	400-R-6	3/8	1/4	1.60	0.70	1.31	0.69	1/2	0.19
8-4 TRBZ	8TUR4	400-R-8	1/2	1/4	1.82	0.70	1.53	0.91	9/16	0.19
10-4 TRBZ	10TUR4	400-R-10	5/8	1/4	1.89	0.70	1.60	0.97	11/16	0.19
12-4 TRBZ	12TUR4	400-R-12	3/4	1/4	1.88	0.70	1.59	0.97	13/16	0.19
6-5 TRBZ	6TUR5	500-R-6	3/8	5/16	1.65	0.73	1.36	0.69	9/16	0.25
8-5 TRBZ	8TUR5	500-R-8	1/2	5/16	1.87	0.73	1.58	0.91	9/16	0.25
4-6 TRBZ	4TUR6	600-R-4	1/4	3/8	1.63	0.76	1.34	0.63	5/8	0.19
6-6 TRBZ	6TUR6	600-R-6	3/8	3/8	1.70	0.76	1.41	0.69	5/8	0.28
8-6 TRBZ	8TUR6	600-R-8	1/2	3/8	1.91	0.76	1.62	0.91	5/8	0.28
10-6 TRBZ	10TUR6	600-R-10	5/8	3/8	1.98	0.76	1.69	0.97	11/16	0.28
12-6 TRBZ	12TUR6	600-R-12	3/4	3/8	1.98	0.76	1.69	0.97	13/16	0.28
4-8 TRBZ	4TUR8	810-R-4	1/4	1/2	1.77	0.87	1.37	0.63	13/16	0.19
6-8 TRBZ	6TUR8	810-R-6	3/8	1/2	1.84	0.87	1.44	0.69	13/16	0.19
10-8 TRBZ	10TUR8	810-R-10	5/8	1/2	2.12	0.87	1.72	0.97	13/16	0.41
12-8 TRBZ	12TUR8	810-R-12	3/4	1/2	2.12	0.87	1.72	0.97	13/16	0.41
16-8 TRBZ	16TUR8	810-R-16	1	1/2	2.37	0.87	1.97	1.22	1-1/16	0.41
12-10 TRBZ	12TUR10	1010-R-12	3/4	5/8	2.15	0.87	1.75	0.97	15/16	0.50
14-10 TRBZ	14TUR10	1010-R-14	7/8	5/8	2.21	0.87	1.81	1.03	15/16	0.50
16-10 TRBZ	16TUR10	1010-R-16	1	5/8	2.40	0.87	2.00	1.22	1-1/16	0.50
8-12 TRBZ	8TUR12	1210-R-8	1/2	3/4	2.15	0.87	1.75	0.91	1-1/16	0.39
16-12 TRBZ	16TUR12	1210-R-16	1	3/4	2.46	0.87	2.06	1.22	1-1/16	0.63
24-16 TRBZ†	24TUR16	1610-R-24	1-1/2	1	3.519	1.05	3.03	2.05	1-5/8	0.88
24-20 TRBZ†	24TUR20	2010-R-24	1-1/2	1-1/4	4.10	1.52	3.23	2.05	1-7/8	1.09
32-24 TRBZ†	32TUR24	2410-R-32	2	1-1/2	5.17	1.52	4.10	2.74	2-1/4	1.34

NOTE: A and C dimensions are typical finger-tight.

Dimensions for reference only, subject to change.

Size 1, 2, and 3 do not require a groove.

Size 4 and above tube stub is pre-grooved as standard. Generic (non-grooved) can be ordered through Quick Response Department.

Sizes 20, 24 require additional lubrication prior to assembly.

Add -Z6 for assembly of nuts and ferrules on the tube stub end.

†All tube stubs over 1" come standard with nuts and ferrule(s) pre-assembled (-Z6 option).

Port Connectors

Tube End Converter

For fractional tube to metric tube

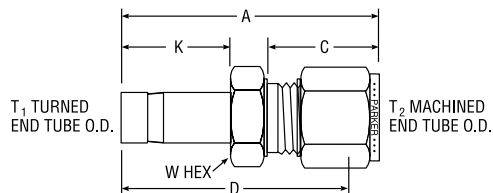
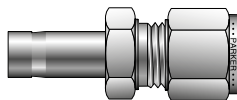

CPI™ PART NO.	A-LOK® PART NO.	INTER- CHANGES WITH	TUBE O.D.		MILLIMETERS					
			T ₁ INCH	T ₂ MM	A	C	D	K	W A/F HEX	BORE
TRBZ 1/8-3	2TUCM3	3MO-R-2	1/8	3	34,3	15,3	27,7	13,5	12,0	1,4
TRBZ 1/4-3	4TUCM3	3MO-R-4	1/4	3	36,1	15,3	29,5	16,0	12,0	4,8
TRBZ 1/4-6	4TUCM6	6MO-R-4	1/4	6	39,3	17,7	31,8	16,0	14,0	4,8
TRBZ 5/16-6	5TUCM6	6MO-R-5	5/16	6	40,0	17,7	32,5	16,8	14,0	6,4
TRBZ 3/8-6	6TUCM6	6MO-R-6	3/8	6	40,8	17,7	33,3	17,5	14,0	7,1
TRBZ 1/2-6	8TUCM6	6MO-R-8	1/2	6	46,4	17,7	38,9	23,1	14,0	9,9
TRBZ 3/8-8	6TUCM8	8MO-R-6	3/8	8	42,0	18,6	34,5	17,5	15,0	7,1
TRBZ 1/2-8	8TUCM8	8MO-R-8	1/2	8	47,5	18,6	40,1	23,1	15,0	9,9
TRBZ 3/8-10	6TUCM10	10MO-R-6	3/8	10	44,4	19,5	36,8	17,5	18,0	7,1
TRBZ 1/2-10	8TUCM10	10MO-R-8	1/2	10	47,6	19,5	41,4	23,1	18,0	9,9
TRBZ 1/2-12	8TUCM12	12MO-R-8	1/2	12	52,3	22,0	42,2	23,1	22,0	9,9
TRBZ 3/4-12	12TUCM12	12MO-R-12	3/4	12	53,8	22,0	43,7	24,6	22,0	15,1
TRBZ 3/4-18	12TUCM18	18MO-R-12	3/4	18	57,5	22,0	47,5	24,6	27,0	15,1

NOTE: A and C dimensions are typical finger-tight.

Dimensions for reference only, subject to change.

Tube stub is pre-grooved as standard. Generic (non-grooved) can be ordered through Quick Response Department.

Size 1, 2, and 3 do not require a groove.

Add -Z6 for assembly of nuts and ferrules on the tube stub end.

Color Coding

For easy reference, table column headings are color indicated as follows:

fractional

metric

Port Connectors

Tube End Reducer For metric tube

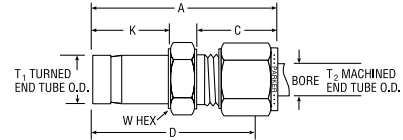
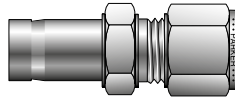

CPI™ PART NO.	A-LOK® PART NO.	INTER- CHANGES WITH	TUBE O.D.		MILLIMETERS							
			T ₁	T ₂	A	C	D	K	O	W HEX	BORE	
TRBZ 3-2	M3TURM2	2MO-R-3M	3	2	34,3	15,3	27,7	13,5	0,6	14,0	1,4	
TRBZ 3-6	M3TURM6	6MO-R-3M	3	6	37,0	17,7	29,5	13,5	0,6	14,0	1,4	
TRBZ 4-3	M4TURM3	3MO-R-4M	4	3	35,0	15,3	28,4	14,3	1,0	12,0	2,0	
TRBZ 6-3	M6TURM3	3MO-R-6M	6	3	36,1	15,3	29,5	15,9	1,0	12,0	2,4	
TRBZ 6-4	M6TURM4	4MO-R-6M	6	4	37,1	16,1	30,5	15,9	1,0	12,0	3,0	
TRBZ 6-8	M6TURM8	8MO-R-6M	6	8	40,0	18,6	32,5	15,9	1,0	15,0	4,0	
TRBZ 6-10	M6TURM10	10MO-R-6M	6	10	41,7	19,5	34,1	15,9	1,0	18,0	4,0	
TRBZ 6-12	M6TURM12	12MO-R-6M	6	12	44,9	22,0	34,8	15,9	1,0	22,0	4,0	
TRBZ 8-6	M8TURM6	6MO-R-8M	8	6	40,0	17,7	32,5	16,7	0,8	14,0	4,8	
TRBZ 8-10	M8TURM10	10MO-R-8M	8	10	43,4	19,5	35,8	15,3	1,5	19,5	18,0	
TRBZ 10-3	M10TURM3	3MO-R-10M	10	3	38,6	15,3	32,0	17,7	2,0	15,3	12,0	
TRBZ 10-6	M10TURM6	6MO-R-10M	10	6	40,8	17,7	33,3	17,5	1,3	14,0	4,8	
TRBZ 10-8	M10TURM8	8MO-R-10M	10	8	42,0	18,6	34,5	17,5	1,3	15,0	6,4	
TRBZ 10-12	M10TURM12	12MO-R-10M	10	12	46,6	22,0	36,5	17,5	1,3	22,0	7,5	
TRBZ 12-6	M12TURM6	6MO-R-12M	12	6	46,4	17,7	38,9	23,0	1,4	14,0	4,8	
TRBZ 12-8	M12TURM8	8MO-R-12M	12	8	47,6	18,6	40,1	23,0	1,4	15,0	6,4	
TRBZ 12-10	M12TURM10	10MO-R-12M	12	10	49,7	19,5	42,1	23,0	1,4	18,0	7,9	
TRBZ 12-16	M12TURM16	16MO-R-12M	12	16	53,0	22,0	42,9	23,0	1,4	24,0	9,1	
TRBZ 12-18	M12TURM18	18MO-R-12M	12	18	54,6	22,0	44,5	23,0	1,4	27,0	9,1	
TRBZ 15-10	M15TURM10	10MO-R-15M	15	10	51,3	19,5	43,7	23,8	1,6	27,0	7,9	
TRBZ 16-12	M16TURM12	12MO-R-16M	16	12	53,8	22,0	43,7	24,6	1,7	22,0	9,5	
TRBZ 16-18	M16TURM18	18MO-R-16M	16	18	56,1	22,0	46,0	24,6	1,7	27,0	12,7	
TRBZ 16-20	M16TURM20	20MO-R-16M	16	20	57,9	22,0	47,8	24,6	1,7	27,0	12,7	
TRBZ 16-25	M16TURM25	25MO-R-16M	16	25	63,2	26,5	51,0	24,8	2,0	26,5	35,0	
TRBZ 18-12	M18TURM12	12MO-R-18M	18	12	53,8	22,0	43,7	24,6	2,0	22,0	9,5	
TRBZ 18-16	M18TURM16	16MO-R-18M	18	16	54,7	22,0	44,6	24,8	2,5	22,0	24,0	
TRBZ 18-20	M18TURM20	20MO-R-18M	18	20	57,9	22,0	47,8	24,6	2,0	30,0	13,9	
TRBZ 18-25	M18TURM25	25MO-R-18M	18	25	63,1	26,5	50,8	24,6	2,0	35,0	14,0	
TRBZ 20-12	M20TURM12	12MO-R-20M	20	12	56,1	22,0	46,0	25,4	2,5	22,0	9,5	
TRBZ 20-16	M20TURM16	16MO-R-20M	20	16	55,3	22,0	45,2	25,6	2,5	22,0	24,0	
TRBZ 20-18	M20TURM18	18MO-R-20M	20	18	57,6	22,0	47,5	25,4	2,5	27,0	15,1	
TRBZ 20-25	M20TURM25	25MO-R-20M	20	25	64,5	26,5	52,3	25,4	2,5	35,0	15,1	
TRBZ 22-18	M22TURM18	18MO-R-22M	22	18	56,1	22,0	46,0	26,2	2,5	27,0	15,1	
TRBZ 22-20	M22TURM20	20MO-R-22M	22	20	57,7	22,0	47,6	26,2	2,5	30,0	15,8	
TRBZ 25-12	M25TURM12	12MO-R-25M	25	12	60,9	22,0	50,8	31,8	2,6	27,0	9,5	
TRBZ 25-16	M25TURM16	16MO-R-25M	25	16	64,0	22,0	51,8	32,0	3,0	22,0	27,0	
TRBZ 25-18	M25TURM18	18MO-R-25M	25	18	62,5	22,0	52,4	31,8	2,6	27,0	15,1	
TRBZ 25-20	M25TURM20	20MO-R-25M	25	20	64,2	22,0	54,1	31,8	2,6	30,0	15,8	

NOTE: A and C dimensions are typical finger-tight.

Dimensions for reference only, subject to change.

Tube stub is pre-grooved as standard.

Add -Z6 for assembly of nuts and ferrules on the tube stub end.

Color Coding

For easy reference, table column headings are color indicated as follows:

fractional

metric

Single/Double Ferrule
Instrument Compression
Fittings

Port Connectors

Tube End Bulkhead Adapter For fractional tube

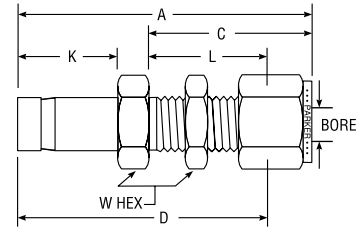
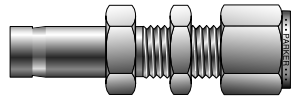

Single/Double Ferrule Instrument Compression Fittings

CPI™ PART NO.	A-LOK® PART NO.	INTER-CHANGES WITH	INCHES							
			TUBE O.D.	A	C	L	K	D	BORE	W HEX
2-2 T2H2BZ	2TUBC2	200-R1-2	1/8	1.95	1.23	0.97	.53	1.69	.093	1/2
4-4 T2H2BZ	4TUBC4	400-R1-4	1/4	2.20	1.31	1.02	.63	1.91	.187	5/8
6-6 TH2HBZ	6TUBC6	600-R1-6	3/8	2.42	1.44	1.16	.69	2.13	.281	3/4
8-8 T2H2BZ	8TUBC8	810-R1-8	1/2	2.87	1.65	1.25	.91	2.47	.406	15/16

NOTE: A and C dimensions are typical finger-tight.

Dimensions for reference only, subject to change.

Tube stub is pre-grooved as standard. Generic (non-grooved) can be ordered through Quick Response Department. Add -Z6 for assembly of nuts and ferrules on the tube stub end.

Port Connector For fractional tube

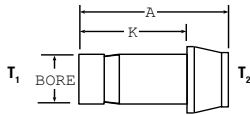
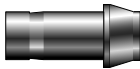

CPI™ PART NO.	A-LOK® PART NO.	INTER-CHANGES WITH	INCHES			
			TUBE O.D.	A	K	BORE
1-1 ZPC	1PC1	101-PC	1/16	0.63	0.44	.031
1-2 ZPC	1PC2	201-PC-1	1/16-1/8	0.84	0.44	.031
1-4 ZPC	1PC4	401-PC-1	1/16-1/4	0.91	0.44	.031
2-2 ZPC	2PC2	201-PC	1/8	0.95	0.54	.078
2-4 ZPC	2PC4	401-PC-2	1/8-1/4	1.05	0.54	.078
2-6 ZPC	2PC6	601-PC-2	1/8-3/8	1.09	0.54	.031
3-3 ZPC	3PC3	301-PC	3/16	0.98	0.67	.116
4-4 ZPC	4PC4	401-PC	1/4	1.07	0.76	.156
4-6 ZPC	4PC6	601-PC-4	1/4-3/8	1.15	0.64	.156
4-8 ZPC	4PC8	811-PC-4	1/4-1/2	1.36	0.64	.156
6-6 ZPC	6PC6	601-PC	3/8	1.16	0.84	.281
6-8 ZPC	6PC8	811-PC-6	3/8-1/2	1.40	0.72	.281
8-8 ZPC	8PC8	811-PC	1/2	1.59	1.11	.375
8-12 ZPC	8PC12	1211-PC-8	1/2-3/4	1.72	0.91	.375
12-12 ZPC	12PC12	1211-PC	3/4	1.65	1.16	.578
16-16 ZPC	16PC16	1611-PC	1	2.12	1.44	.813

Dimensions for reference only, subject to change.

NOTE: Tube stub is pre-grooved as standard. (Size 1, 2, and 3 not grooved). Generic (non-grooved 4-16) can be ordered through Quick Response Department.

The machined ferrule end (T₂) requires only 1/4 turn from finger tight to assemble. Add -Z6 for assembly of nuts and ferrules on the tube stub end.

Port Connector For metric tube

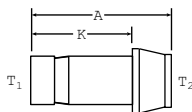
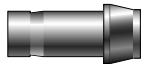

CPI™ PART NO.	A-LOK® PART NO.	INTER-CHANGES WITH	MILLIMETERS				
			TUBE O.D.		A	K	BORE
T ₁	T ₂						
ZPC 3-3	PCM3	3M1-PC	3	3	22,2	15,7	1,6
ZPC 6-6	PCM6	6M1-PC	6	6	24,6	18,7	3,0
ZPC 8-8	PCM8	8M1-PC	8	8	25,9	20,0	5,0
ZPC 10-10	PCM10	10M1-PC	10	10	26,1	20,2	6,0
ZPC 12-12	PCM12	12M1-PC	12	12	35,8	26,0	8,0
ZPC 16-16	PCM16	16M1-PC	16	16	40,5	27,7	12,0
ZPC 18-18	PCM18	18M1-PC	18	18	40,8	27,7	13,0
ZPC 3-6	M3PCM6	6M1-PC-3M	3	6	22,6	13,5	1,6
ZPC 6-8	M6PCM8	8M1-PC-6M	6	8	25,5	16,1	3,0
ZPC 6-10	M6PCM10	10M1-PC-6M	6	10	25,5	16,1	3,0
ZPC 6-12	M6PCM12	12M1-PC-6M	6	12	31,2	16,1	3,0
ZPC 8-10	M8PCM10	10M1-PC-8M	8	10	29,5	16,8	5,0
ZPC 8-12	M8PCM12	12M1-PC-8M	8	12	31,4	16,8	5,0

Dimensions for reference only, subject to change.

NOTE: Tube stub is pre-grooved as standard. (Size M2, M3, and M4 not grooved).

The machined ferrule end (T₂) requires only 1/4 turn from finger tight to assemble. Add -Z6 for assembly of nuts and ferrules on the tube stub end.

Port Connectors

NPT Tube End Male Adapter For fractional tube

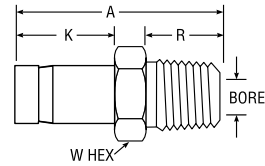
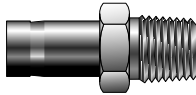

CPI™ PART NO.	A-LOK® PART NO.	INTER- CHANGES WITH	INCHES						
			TUBE O.D.	NPT PIPE THREAD	A	R	K	W HEX	BORE
1-2 T2HF	1MA2N	1-TA-1-1	1/16	1/8	1.00	0.38	0.38	7/16	.031
2-2 T2HF	2MA2N	2-TA-1-2	1/8	1/8	1.16	0.38	0.54	7/16	.078
2-4 T2HF	2MA4N	2-TA-1-4	1/8	1/4	1.38	0.56	0.54	9/16	.078
3-2 T2HF	3MA2N	3-TA-1-2	3/16	1/8	1.20	0.38	0.58	7/16	.116
3-4 T2HF	3MA4N	3-TA-1-4	3/16	1/4	1.42	0.56	0.58	9/16	.116
4-2 T2HF	4MA2N	4-TA-1-2	1/4	1/8	1.25	0.38	0.63	7/16	.156
4-4 T2HF	4MA4N	4-TA-1-4	1/4	1/4	1.46	0.56	0.63	9/16	.156
4-6 T2HF	4MA6N	4-TA-1-6	1/4	3/8	1.49	0.56	0.63	11/16	.156
4-8 T2HF	4MA8N	4-TA-1-8	1/4	1/2	1.71	0.75	0.63	7/8	.156
5-2 T2HF	5MA2N	5-TA-1-2	5/16	1/8	1.29	0.38	0.66	7/16	.219
5-4 T2HF	5MA4N	5-TA-1-4	5/16	1/4	1.50	0.56	0.66	9/16	.219
5-6 T2HF	5MA6N	5-TA-1-6	5/16	3/8	1.53	0.56	0.66	11/16	.219
5-8 T2HF	5MA8N	5-TA-1-8	5/16	1/2	1.74	0.75	0.66	7/8	.219
6-2 T2HF	6MA2N	6-TA-1-2	3/8	1/8	1.32	0.38	0.69	7/16	.281
6-4 T2HF	6MA4N	6-TA-1-4	3/8	1/4	1.53	0.56	0.69	9/16	.281
6-6 T2HF	6MA6N	6-TA-1-6	3/8	3/8	1.56	0.56	0.69	11/16	.281
6-8 T2HF	6MA8N	6-TA-1-8	3/8	1/2	1.78	0.75	0.69	7/8	.281
8-4 T2HF	8MA4N	8-TA-1-4	1/2	1/4	1.75	0.56	0.91	9/16	.281
8-6 T2HF	8MA6N	8-TA-1-6	1/2	3/8	1.78	0.56	0.91	11/16	.375
8-8 T2HF	8MA8N	8-TA-1-8	1/2	1/2	2.00	0.75	0.91	7/8	.375
10-8 T2HF	10MA8N	10-TA-1-8	5/8	1/2	2.06	0.75	0.97	7/8	.469
12-8 T2HF	12MA8N	12-TA-1-8	3/4	1/2	2.06	0.75	0.97	7/8	.469
12-12 T2HF	12MA12N	12-TA-1-12	3/4	3/4	2.06	0.75	0.97	1-1/16	.578
12-16 T2HF	12MA16N	12-TA-1-16	3/4	1	2.41	0.94	0.97	1-3/8	.813
16-12 T2HF	16MA12N	16-TA-1-12	1	3/4	2.31	0.75	1.22	1-1/16	.813
16-16 T2HF	16MA16N	16-TA-1-16	1	1	2.68	0.94	1.22	1-3/8	.813
20-20 T2HF	20MA20N	20-TA-1-20	1-1/4	1-1/4	3.16	0.97	1.71	1-3/4	1.000
24-24 T2HF	24MA24N	24-TA-1-24	1-1/2	1-1/2	3.72	1.00	2.05	2-1/8	1.250
32-32 T2HF	32MA32N	32-TA-1-32	2	2	4.70	1.04	2.74	2-3/4	1.720

NOTE: Add -Z6 for assembly of nuts and ferrules on the tube stub end.

Dimensions for reference only, subject to change.

Tube stub is pre-grooved as standard. Generic (non-grooved) can be ordered through Quick Response Department.
Inch sizes 1, 2, and 3 and metric sizes 2, 3, and 4mm do not have grooves.
Sizes 20, 24, 32 require additional lubrication prior to assembly.

BSPF Tube End Male Adapter For fractional tube

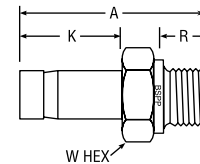
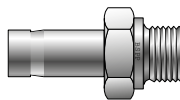

CPI™ PART NO.	A-LOK® PART NO.	INTER- CHANGES WITH	INCHES						
			TUBE O.D.	BSPF THREAD	A	K	R	W HEX	BORE
2-2R T2HF	2MA2R	2TA-1-2RS	1/8	1/8	1.09	0.53	.28	9/16	.05
2-4R T2HF	2MA4R	2TA-1-4RS	1/8	1/4	1.31	0.53	.44	3/4	.05
4-2R T2HF	4MA2R	4TA-1-2RS	1/4	1/8	1.19	0.63	.28	9/16	.16
4-4R T2HF	4MA4R	4TA-1-4RS	1/4	1/4	1.50	0.63	.44	3/4	.18
6-2R T2HF	6MA2R	6TA-1-2RS	3/8	1/8	1.34	0.69	.28	3/4	.05
6-4R T2HF	6MA4R	6TA-1-4RS	3/8	1/4	1.47	0.69	.44	3/4	.25
6-6R T2HF	6MA6R	6TA-1-6RS	3/8	3/8	1.50	0.69	.44	7/8	.28
6-8R T2HF	6MA8R	6TA-1-8RS	3/8	1/2	1.69	0.69	.56	1-1/16	.28
8-4R T2HF	8MA4R	8TA-1-4RS	1/2	1/4	1.69	0.91	.44	3/4	.25
8-6R T2HF	8MA6R	8TA-1-6RS	1/2	3/8	1.72	0.91	.44	7/8	.31
8-8R T2HF	8MA8R	8TA-1-8RS	1/2	1/2	1.94	0.91	.56	1-1/16	.39
10-8R T2HF	10MA8R	10TA-1-8RS	5/8	1/2	1.97	0.97	.56	1-1/16	.47
12-12R T2HF	12MA12R	12TA-1-12RS	3/4	3/4	2.09	0.97	.63	1-5/16	.578
16-16R T2HF	16MA16R	16TA-1-16RS	1	1	2.53	1.22	.72	1-5/8	.80

NOTE: Add -Z6 for assembly of nuts and ferrules on the tube stub end.

Dimensions for reference only, subject to change.

Tube stub is pre-grooved as standard. Generic (non-grooved) can be ordered through Quick Response Department.
Bonded sealing washer must be used with this design, see page 105.

Single/Double Ferrule
Instrument Compression
Fittings

Port Connectors

BSPB Tube End Male Adapter For metric tube

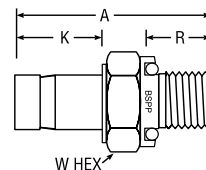
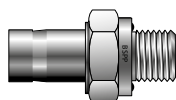

CPI™ PART NO.	A-LOK® PART NO.	INTER- CHANGES WITH	MILLIMETERS								
			TUBE O.D.	BSPP THREAD	A	K	Q	R	X	W HEX	BORE
T2HF 3-1/8R	M3MA1/8R	3-MTA-1-2RS	3	1/8	31,0	13,5	0,6	7,1	13,7	14,0	1,8
T2HF 4-1/8R	M4MA1/8R	4-MTA-1-2RS	4	1/8	31,8	14,3	1,0	7,1	13,7	14,0	2,0
T2HF 6-1/8R	M6MA1/8R	6-MTA-1-2RS	6	1/8	33,3	15,9	1,0	7,1	13,7	14,0	4,0
T2HF 6-1/4R	M6MA1/4R	6-MTA-1-4RS	6	1/4	38,1	15,9	1,0	11,2	17,8	19,0	4,0
T2HF 8-1/4R	M8MA1/4R	8-MTA-1-4RS	8	1/4	38,9	16,7	0,8	11,2	17,8	19,0	6,4
T2HF 10-1/4R	M10MA1/4R	10-MTA-1-4RS	10	1/4	39,7	17,5	1,3	11,2	17,8	19,0	6,4
T2HF 10-3/8R	M10MA3/8R	10-MTA-1-6RS	10	3/8	38,9	17,5	1,3	11,2	21,8	22,0	7,5
T2HF 10-1/2R	M10MA1/2R	10-MTA-1-8RS	10	1/2	42,9	17,5	1,3	14,2	25,7	27,0	7,5
T2HF 12-1/4R	M12MA1/4R	12-MTA-1-4RS	12	1/4	43,7	23,0	1,4	11,2	17,8	19,0	6,4
T2HF 12-3/8R	M12MA3/8R	12-MTA-1-6RS	12	3/8	44,5	23,0	1,4	11,2	21,8	22,0	7,9
T2HF 12-1/2R	M12MA1/2R	12-MTA-1-8RS	12	1/2	49,2	23,0	1,4	14,2	25,7	27,0	9,1
T2HF 16-1/2R	M16MA1/2R	16-MTA-1-8RS	16	1/2	50,8	24,6	1,7	14,2	25,7	27,0	11,9
T2HF 18-3/4R	M18MA3/4R	18-MTA-1-12RS	18	3/4	53,2	24,6	2,0	16,0	31,8	33,0	14,0
T2HF 20-3/4R	M20MA3/4R	20-MTA-1-12RS	20	3/4	54,0	25,4	2,5	16,0	31,8	33,0	15,1
T2HF 25-1R	M25MA1R	25-MTA-1-16RS	25	1	65,1	31,8	2,6	18,3	38,6	41,0	19,8

Dimensions for reference only, subject to change.

NOTE: Tube stub is pre-grooved as standard. Generic (non-grooved) can be ordered through Quick Response Department.

Bonded sealing washer must be used with this design, see page 105.
Add -Z6 for assembly of nuts and ferrules on the tube stub end.

BSPB Tube End Male Adapter with ED Seal For fractional tube

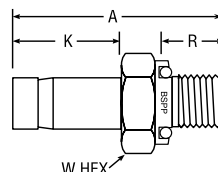
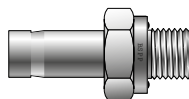

CPI™ PART NO.	A-LOK® PART NO.	INTER- CHANGES WITH	INCHES								
			TUBE O.D.	BSPP THREAD	A	K	R	X	W HEX	BORE	
4-4R-ED T2HF	4MA4R-ED	-	1/4	1/4	1.50	.63	.47	0.74	3/4	.18	
4-6R-ED T2HF	4MA6R-ED	-	1/4	3/8	1.50	.63	.47	0.86	3/4	.18	
8-4R-ED T2HF	8MA4R-ED	-	1/2	1/4	1.75	.91	.47	0.74	3/4	.25	
8-6R-ED T2HF	8MA6R-ED	-	1/2	3/8	1.78	.91	.47	0.86	7/8	.31	
8-8R-ED T2HF	8MA8R-ED	-	1/2	1/2	1.94	.91	.55	1.04	1-1/16	.39	

Dimensions for reference only, subject to change.

NOTE: Tube stub is pre-grooved as standard. Generic (non-grooved) can be ordered through Quick Response Department.

ED fittings are supplied with sealing washers in nitrile as standard, suitable for temperatures between -35°C and +100°C (-31°F to +212°F). Fluorocarbon seals are available upon request which are suitable for temperatures between -25°C and +120°C (-13°F to +248°F).
Add -Z6 for assembly of nuts and ferrules on the tube stub end.

Color Coding

For easy reference, table column headings are color indicated as follows:

fractional



metric



Port Connectors

BSPP Tube End Male Adapter with ED Seal For metric tube

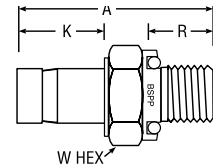
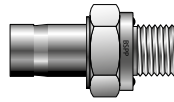

CPI™ PART NO.	A-LOK® PART NO.	INTER- CHANGES WITH	MILLIMETERS						
			TUBE O.D.	BSPP THREAD	A	K	R	W HEX	BORE
T2HF 6-1/4R-ED	M6MA1/4R-ED	-	6	1/4	36,6	15,9	7,9	19,0	4,0
T2HF 6-1/2R-ED	M6MA1/2R-ED	-	6	1/2	42,7	15,9	14,0	27,0	4,0
T2HF 10-1/4R-ED	M10MA1/4R-ED	-	10	1/4	38,1	17,5	11,9	19,0	6,4
T2HF 10-1/2R-ED	M10MA1/2R-ED	-	10	1/2	44,2	17,5	14,0	27,0	7,5
T2HF 12-1/4R-ED	M12MA1/4R-ED	-	12	1/4	43,7	23,0	11,9	19,0	6,4
T2HF 12-3/8R-ED	M12MA3/8R-ED	-	12	3/8	45,0	23,0	11,9	22,0	7,9
T2HF 12-1/2R-ED	M12MA1/2R-ED	-	12	1/2	49,8	23,0	14,0	27,0	9,1

Dimensions for reference only, subject to change.

NOTE: Tube stub is pre-grooved as standard. Generic (non-grooved) can be ordered through Quick Response Department.

ED fittings are supplied with sealing washers in nitrile as standard, suitable for temperatures between -35°C and +100°C (-31°F to +212°F). Fluorocarbon seals are available upon request which are suitable for temperatures between -25°C and +120°C (-13°F to +248°F). Add -Z6 for assembly of nuts and ferrules on the tube stub end.

NPT Male Adapter For metric tube

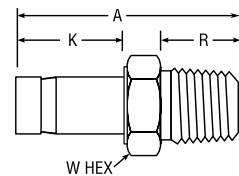
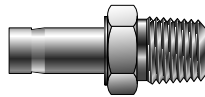

CPI™ PART NO.	A-LOK® PART NO.	INTER- CHANGES WITH	MILLIMETERS						
			TUBE O.D.	NPT THREAD	A	K	R	W HEX	BORE
T2HF 3-1/8	M3MA1/8N	3-MTA-1-2	3	1/8	29,4	13,5	9,7	12,0	1,8
T2HF 4-1/8	M4MA1/8N	4-MTA-1-2	4	1/8	29,4	14,3	9,7	12,0	2,0
T2HF 6-1/8	M6MA1/8N	6-MTA-1-2	6	1/8	31,0	15,9	9,7	12,0	4,0
T2HF 6-1/4	M6MA1/4N	6-MTA-1-4	6	1/4	35,7	15,9	14,2	14,0	4,0
T2HF 6-3/8	M6MA3/8N	6-MTA-1-6	6	3/8	36,5	16,1	14,2	18,0	3,0
T2HF 6-1/2	M6MA1/2N	6-MTA-1-8	6	1/2	42,1	16,1	19,1	22,0	3,0
T2HF 8-1/4	M8MA1/4N	8-MTA-1-4	8	1/4	37,3	16,7	14,2	14,0	6,4
T2HF 8-3/8	M8MA3/8N	8-MTA-1-6	8	3/8	38,1	16,7	14,2	12,0	6,4
T2HF 10-1/4	M10MA1/4N	10-MTA-1-4	10	1/4	38,1	17,5	14,2	14,0	7,1
T2HF 10-3/8	M10MA3/8N	10-MTA-1-6	10	3/8	43,7	17,5	14,2	18,0	7,5
T2HF 10-1/2	M10MA1/2N	10-MTA-1-8	10	1/2	44,5	17,5	19,1	22,0	7,5
T2HF 12-1/4	M12MA1/4N	12-MTA-1-4	12	1/4	43,7	23,0	14,2	14,0	7,1
T2HF 12-3/8	M12MA3/8N	12-MTA-1-6	12	3/8	44,5	23,0	14,2	27,0	9,1
T2HF 12-1/2	M12MA1/2N	12-MTA-1-8	12	1/2	49,2	23,0	19,1	22,0	9,1
T2HF 16-1/2	M16MA1/2N	16-MTA-1-8	16	1/2	50,8	24,6	19,1	22,0	12,7
T2HF 16-3/4	M16MA3/4N	16-MTA-1-12	16	3/4	51,6	24,6	19,1	27,0	12,7
T2HF 18-1/2	M18MA1/2N	18-MTA-1-8	18	1/2	50,8	24,6	19,1	22,0	12,7
T2HF 18-3/4	M18MA3/4N	18-MTA-1-12	18	3/4	51,6	24,6	19,1	27,0	14,0
T2HF 20-1/2	M20MA1/2N	20-MTA-1-8	20	1/2	51,8	25,6	19,1	22,0	15,0
T2HF 20-3/4	M20MA3/4N	20-MTA-1-12	20	3/4	52,4	25,4	19,1	27,0	15,1
T2HF 25-1	M25MA1N	25-MTA-1-16	25	1	65,9	31,8	23,9	35,0	19,8

Dimensions for reference only, subject to change.

NOTE: Tube stub is pre-grooved as standard. Generic (non-grooved) can be ordered through Quick Response Department.

Add -Z6 for assembly of nuts and ferrules on the tube stub end.

Color Coding

For easy reference, table column headings are color indicated as follows:

fractional



metric



Port Connectors

BSP Taper Male Adapter For fractional tube

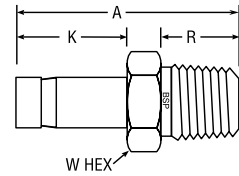
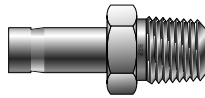

CPI™ PART NO.	A-LOK® PART NO.	INTER- CHANGES WITH	INCHES						
			TUBE O.D.	BSPT THREAD	A	K	R	W HEX	BORE
4-2K T2HFK	4MA2K	4-TA-1-2RT	1/4	1/8	1.25	.63	.38	7/16	.156
4-4K T2HFK	4MA4K	4-TA-1-4RT	1/4	1/4	1.46	.63	.56	9/16	.156
4-6K T2HFK	4MA6K	4-TA-1-6RT	1/4	3/8	1.44	.63	.56	11/16	.156
4-8K T2HFK	4MA8K	4-TA-1-8RT	1/4	1/2	1.66	.63	.75	7/8	.219
5-2 T2HFK	5MA2K	5-TA-1-2RT	5/16	1/8	1.29	.66	.38	7/16	.219
5-4 T2HFK	5MA4K	5-TA-1-4RT	5/16	1/4	1.50	.66	.56	9/16	.219
6-4 T2HFK	6MA4K	6-TA-1-4RT	3/8	1/4	1.50	.69	.56	9/16	.281
6-6 T2HFK	6MA6K	6-TA-1-6RT	3/8	3/8	1.50	.69	.56	11/16	.281
6-8 T2HFK	6MA8K	6-TA-1-8RT	3/8	1/2	1.72	.69	.75	7/8	.281
8-4 T2HFK	8MA4K	8-TA-1-4RT	1/2	1/4	1.72	.91	.56	9/16	.375
8-6 T2HFK	8MA6K	8-TA-1-6RT	1/2	3/8	1.75	.91	.56	11/16	.375
8-8 T2HFK	8MA8K	8-TA-1-8RT	1/2	1/2	1.94	.91	.75	7/8	.375
10-8 T2HFK	10MA8K	10-TA-1-8RT	5/8	1/2	2.06	.97	.75	7/8	.469

Dimensions for reference only, subject to change.

NOTE: Tube stub is pre-grooved as standard. Generic (non-grooved) can be ordered through Quick Response Department.

Add -Z6 for assembly of nuts and ferrules on the tube stub end.

BSP Taper Male Adapter For metric tube

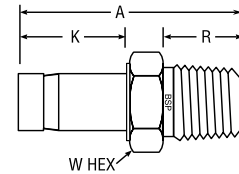
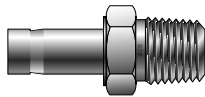

CPI™ PART NO.	A-LOK® PART NO.	INTER- CHANGES WITH	MILLIMETERS						
			TUBE O.D.	BSPT THREAD	A	K	R	W HEX	BORE
T2HF 3-1/8K	M3MA1/8K	3-MTA-1-2RT	3	1/8	29,4	13,5	9,7	12,0	1,8
T2HF 4-1/8K	M4MA1/8K	4-MTA-1-2RT	4	1/8	29,4	14,3	9,7	12,0	2,0
T2HF 6-1/8K	M6MA1/8K	6-MTA-1-2RT	6	1/8	31,0	15,9	9,7	12,0	4,0
T2HF 6-1/4K	M6MA1/4K	6-MTA-1-4RT	6	1/4	35,7	15,9	14,2	14,0	4,0
T2HF 8-1/4K	M8MA1/4K	8-MTA-1-4RT	8	1/4	37,3	16,7	14,2	14,0	6,4
T2HF 8-3/8K	M8MA3/8K	8-MTA-1-6RT	8	3/8	38,3	16,8	14,2	18,0	5,0
T2HF 10-1/4K	M10MA1/4K	10-MTA-1-4RT	10	1/4	38,1	17,5	14,2	14,0	7,1
T2HF 10-3/8K	M10MA3/8K	10-MTA-1-6RT	10	3/8	38,1	17,5	14,2	18,0	7,5
T2HF 10-1/2K	M10MA1/2K	10-MTA-1-8RT	10	1/2	44,5	17,5	19,1	22,0	7,5
T2HF 12-1/4K	M12MA1/4K	12-MTA-1-4RT	12	1/4	43,7	23,0	14,2	14,0	7,1
T2HF 12-3/8K	M12MA3/8K	12-MTA-1-6RT	12	3/8	44,5	23,0	14,2	18,0	9,1
T2HF 12-1/2K	M12MA1/2K	12-MTA-1-8RT	12	1/2	49,2	23,0	19,1	22,0	9,1
T2HF 16-1/2K	M16MA1/2K	16-MTA-1-8RT	16	1/2	50,8	24,6	19,1	22,0	12,7
T2HF 18-3/4K	M18MA3/4K	18-MTA-1-12RT	18	3/4	51,6	24,6	19,1	27,0	14,0
T2HF 20-3/4K	M20MA3/4K	20-MTA-1-12RT	20	3/4	52,4	25,4	19,1	27,0	15,1
T2H 25-1K	M25MA1K	25-MTA-1-16RT	25	1	65,9	31,8	23,9	35,0	19,8

Dimensions for reference only, subject to change.

NOTE: Tube stub is pre-grooved as standard. Generic (non-grooved) can be ordered through Quick Response Department.

Add -Z6 for assembly of nuts and ferrules on the tube stub end.

Port Connectors

Tube End to SAE Straight Thread Adapter

For fractional tube

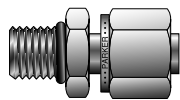
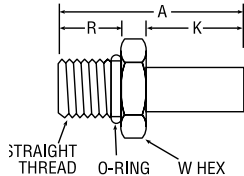
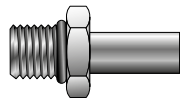

CPI™ PART NO.	A-LOK® PART NO.	INTER-CHANGES WITH	INCHES						O-RING APR UNIFORM DASH NO.
			T TUBE O.D.	STRAIGHT THREAD SIZE	A	K	R	W HEX	
6-4 T2HOA	6TUHOA4	6-TA-1-4ST	3/8	7/16-20	1.46	0.69	.36	9/16	3-904
6-8 T2HOA	6TUHOA8	6-TA-1-8ST	3/8	3/4-16	1.59	0.69	.44	7/8	3-908
8-6 T2HOA	8TUHOA6	8-TA-1-6ST	1/2	9/16-18	1.74	0.91	.39	11/16	3-906
10-10 T2HOA	10TUHOA10	10-TA-1-10ST	5/8	7/8-14	1.94	0.91	.50	1	3-910
*24-24 T2HOA	24TUHOA24	24-TA-1-24ST	1-1/2	1-7/8-12	3.28	2.05	.59	2-1/8	3-924

* Size 24 is preassembled with nut and ferrules.

Dimensions for reference only, subject to change.

A dimension is typical finger-tight.

Size 24 requires additional lubrication prior to assembly.

Parts are supplied with nitrile o-rings as standard. For Fluorocarbon o-rings, add the suffix "-VO".

Other o-rings available upon request.

Add -Z6 for assembly of nuts and ferrules on the tube stub end.

Single/Double Ferrule Instrument Compression Fittings

Tube End NPT Female Adapter

For fractional tube

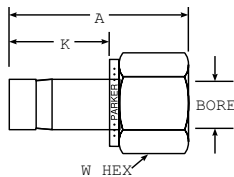
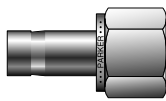

CPI™ PART NO.	A-LOK® PART NO.	INTER-CHANGES WITH	INCHES					
			TUBE O.D.	NPT PIPE THREAD	A	K	W HEX	BORE
1-2 T2HG	1FA2N	1-TA-7-2	1/16	1/8	1.07	0.34	9/16	.031
2-2 T2HG	2FA2N	2-TA-7-2	1/8	1/8	1.23	0.53	9/16	.093
2-4 T2HG	2FA4N	2-TA-7-4	1/8	1/4	1.38	0.53	3/4	.093
3-2 T2HG	3FA2N	3-TA-7-2	3/16	1/8	1.25	0.56	9/16	.116
3-4 T2HG	3FA4N	3-TA-7-4	3/16	1/4	1.42	0.56	3/4	.116
4-2 T2HG	4FA2N	4-TA-7-2	1/4	1/8	1.31	0.63	9/16	.188
4-4 T2HG	4FA4N	4-TA-7-4	1/4	1/4	1.47	0.63	3/4	.188
4-6 T2HG	4FA6N	4-TA-7-6	1/4	3/8	1.56	0.63	7/8	.188
4-8 T2HG	4FA8N	4-TA-7-8	1/4	1/2	1.80	0.63	1-1/16	.188
5-2 T2HG	5FA2N	5-TA-7-2	5/16	1/8	1.34	0.66	9/16	.219
5-4 T2HG	5FA4N	5-TA-7-4	5/16	1/4	1.50	0.66	3/4	.219
5-6 T2HG	5FA6N	5-TA-7-6	5/16	3/8	1.59	0.66	7/8	.219
6-2 T2HG	6FA2N	6-TA-7-2	3/8	1/8	1.36	0.69	9/16	.281
6-4 T2HG	6FA4N	6-TA-7-4	3/8	1/4	1.55	0.69	3/4	.281
6-6 T2HG	6FA6N	6-TA-7-6	3/8	3/8	1.59	0.69	7/8	.281
6-8 T2HG	6FA8N	6-TA-7-8	3/8	1/2	1.84	0.69	1-1/16	.281
8-4 T2HG	8FA4N	8-TA-7-4	1/2	1/4	1.72	0.91	3/4	.391
8-6 T2HG	8FA6N	8-TA-7-6	1/2	3/8	1.80	0.91	7/8	.391
8-8 T2HG	8FA8N	8-TA-7-8	1/2	1/2	2.10	0.91	1-1/16	.390
10-6 T2HG	10FA6N	10-TA-7-6	5/8	3/8	1.86	0.97	7/8	.469
10-8 T2HG	10FA8N	10-TA-7-8	5/8	1/2	2.09	0.97	1-1/16	.469
12-8 T2HG	12FA8N	12-TA-7-8	3/4	1/2	2.10	0.97	1-1/16	.578
12-12 T2HG	12FA12N	12-TA-7-12	3/4	3/4	2.16	0.97	1-1/4	.578
12-16 T2HG	12FA16N	12-TA-7-16	3/4	1	2.30	0.97	1-5/8	.578
14-12 T2HG	14FA12N	14-TA-7-12	7/8	3/4	2.22	1.02	1-5/16	.578
16-12 T2HG	16FA12N	16-TA-7-12	1	3/4	2.41	1.22	1-5/16	.813
16-16 T2HG	16FA16N	16-TA-7-16	1	1	2.54	1.22	1-5/8	.813
20-20 T2HG	20FA20N	20-TA-7-20	1-1/4	1-1/4	3.06	1.71	2-1/8	1.000
24-24 T2HG	24FA24N	24-TA-7-24	1-1/2	1-1/2	3.50	2.05	2-3/8	1.250
32-32 T2HG	32FA32N	32-TA-7-32	2	2	4.23	2.74	2-7/8	1.720

NOTE: Tube stub is pre-grooved as standard.

Dimensions for reference only, subject to change.

Generic (non-grooved) can be ordered through Quick Response Department.

Add -Z6 for assembly of nuts and ferrules on the tube stub end.

Color Coding

For easy reference, table column headings are color indicated as follows:

fractional

metric

Port Connectors

Single/Double Ferrule
Instrument Compression
Fittings

Tube End NPT Female Adapter For metric tube

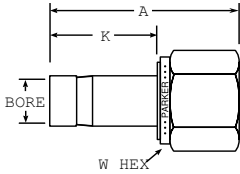
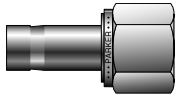

CPI™ PART NO.	A-LOK® PART NO.	INTER- CHANGES WITH	MILLIMETERS					
			TUBE O.D.	NPT THREAD	A	K	W HEX	BORE
T2HG 3-1/8	M3FA1/8N	3-MTA-7-2	3	1/8	31,3	13,5	14,0	1,3
T2HG 4-1/8	M4FA1/8N	4-MTA-7-2	4	1/8	29,4	14,3	14,0	2,0
T2HG 6-1/8	M6FA1/8N	6-MTA-7-2	6	1/8	29,4	15,9	14,0	4,0
T2HG 6-1/4	M6FA1/4N	6-MTA-7-4	6	1/4	34,1	15,9	19,0	4,0
T2HG 8-1/8	M8FA1/8N	8-MTA-7-2	8	1/8	35,5	16,7	14,0	6,4
T2HG 8-1/4	M8FA1/4N	8-MTA-7-4	8	1/4	35,1	16,7	19,0	6,4
T2HG 8-3/8	M8FA3/8N	8-MTA-7-6	8	3/8	36,5	16,7	22,0	6,4
T2HG 10-1/4	M10FA1/4N	10-MTA-7-4	10	1/4	37,3	17,5	19,0	7,5
T2HG 10-3/8	M10FA3/8N	10-MTA-7-6	10	3/8	37,3	17,5	22,0	7,5
T2HG 10-1/2	M10FA1/2N	10-MTA-7-8	10	1/2	42,1	17,5	27,0	7,5
T2HG 12-1/4	M12FA1/4N	12-MTA-7-4	12	1/4	41,3	23,0	19,0	9,1
T2HG 12-3/8	M12FA3/8N	12-MTA-7-6	12	3/8	42,9	23,0	22,0	9,1
T2HG 12-1/2	M12FA1/2N	12-MTA-7-8	12	1/2	47,6	23,0	27,0	9,1
T2HG 16-1/2	M16FA1/2N	16-MTA-7-8	16	1/2	49,2	24,6	27,0	12,7
T2HG 18-3/4	M18FA3/4N	18-MTA-7-12	18	3/4	52,4	24,6	33,0	14,0
T2HG 20-1/2	M20FA1/2N	20-MTA-7-8	20	1/2	50,0	25,6	27,0	15,0
T2HG 20-3/4	M20FA3/4N	20-MTA-7-12	20	3/4	53,2	25,4	33,0	15,1
T2G 25-1	M25FA1N	25-MTA-7-16	25	1	66,7	31,8	41,0	19,8

NOTE: Tube stub is pre-grooved as standard.

Dimensions for reference only, subject to change.

Generic (non-grooved) can be ordered through Quick Response Department.
Add -Z6 for assembly of nuts and ferrules on the tube stub end.

BSP Taper Female Adapter For fractional tube

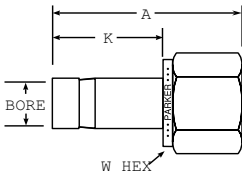
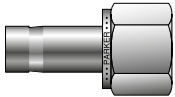

CPI™ PART NO.	A-LOK® PART NO.	INTER- CHANGES WITH	INCHES					
			TUBE O.D.	BSPT THREAD	A	K	W HEX	BORE
4-2K T2HG	4FA2K	4-TR-7-2RT	1/4	1/8-28	1.31	.64	9/16	.156
4-4K T2HG	4FA4K	4-TR-7-4RT	1/4	1/4-19	1.48	.64	3/4	.156
6-4K T2HG	6FA4K	6-TR-7-4RT	3/8	1/4-19	1.56	.72	3/4	.281
6-6K T2HG	6FA6K	6-TR-7-6RT	3/8	3/8-19	1.63	.72	7/8	.281
8-4K T2HG	8FA4K	8-TR-7-4RT	1/2	1/4-19	1.83	.98	3/4	.375
8-6K T2HG	8FA6K	8-TR-7-6RT	1/2	3/8-19	1.89	.98	7/8	.375
8-8K T2HG	8FA8K	8-TR-7-8RT	1/2	1/2-14	2.14	.98	1-1/16	.375

NOTE: Tube stub is pre-grooved as standard.

Dimensions for reference only, subject to change.

Generic (non-grooved) can be ordered through Quick Response Department.
Add -Z6 for assembly of nuts and ferrules on the tube stub end.

BSP Taper Female Adapter For metric tube

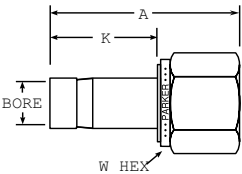
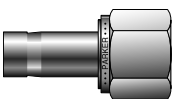

CPI™ PART NO.	A-LOK® PART NO.	INTER- CHANGES WITH	MILLIMETERS					
			TUBE O.D.	BSPT THREAD	A	K	W HEX	BORE
T2HG 3-1/8K	M3FA1/8K	3-MTA-7-2RT	3	1/8	27,8	13,5	14,0	1,8
T2HG 4-1/8K	M4FA1/8K	4-MTA-7-2RT	4	1/8	28,6	14,3	14,0	2,0
T2HG 6-1/8K	M6FA1/8K	6-MTA-7-2RT	6	1/8	30,2	15,9	14,0	4,0
T2HG 8-1/4K	M8FA1/4K	8-MTA-7-4RT	8	1/4	39,1	16,7	19,0	6,4
T2HG 10-1/4K	M10FA1/4K	10-MTA-7-4RT	10	1/4	36,5	17,5	19,0	7,5
T2HG 10-3/8K	M10FA3/8K	10-MTA-7-6RT	10	3/8	31,8	17,5	22,0	7,5
T2HG 10-1/2K	M10FA1/2K	10-MTA-7-8RT	10	1/2	41,3	17,5	27,0	7,5
T2HG 12-1/4K	M12FA1/4K	12-MTA-7-4RT	12	1/4	40,5	23,0	19,0	9,1
T2HG 12-3/8K	M12FA3/8K	12-MTA-7-6RT	12	3/8	43,7	23,0	22,0	9,1
T2HG 12-1/2K	M12FA1/2K	12-MTA-7-8RT	12	1/2	46,8	23,0	27,0	9,1
T2HG 16-1/2K	M16FA1/2K	16-MTA-7-8RT	16	1/2	48,4	24,6	27,0	12,7
T2HG 18-3/4K	M18FA3/4K	18-MTA-7-12RT	18	3/4	51,6	24,6	32,0	14,0
T2HG 20-3/4K	M20FA3/4K	20-MTA-7-12RT	20	3/4	52,4	25,4	32,0	15,1
T2HG 25-1K	M25FA1K	25-MTA-7-16RT	25	1	66,7	31,8	41,0	19,8

NOTE: Tube stub is pre-grooved as standard.

Dimensions for reference only, subject to change.

Add -Z6 for assembly of nuts and ferrules on the tube stub end.

Port Connectors

BSPF Female Adapter For fractional tube

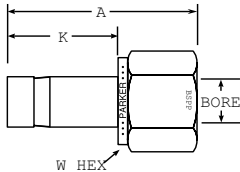
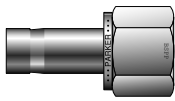

CPI™ PART NO.	A-LOK® PART NO.	INTER- CHANGES WITH	INCHES					
			TUBE O.D.	BSPP THREAD	A	K	W HEX	BORE
4-4R T2HG	4FA4R	4-TA-7-4RP	1/4	1/4	1.68	.63	3/4	.18
6-6R T2HG	6FA6R	6-TA-7-6RP	3/8	3/8	1.53	.69	7/8	.28
8-8R T2HG	8FA8R	8-TA-7-8RP	1/2	1/2	1.91	.91	1-1/16	.39

NOTE: Copper washer must be used for this design.

Dimensions for reference only, subject to change.

Tube stub is pre-grooved as standard. Generic (non-grooved) can be ordered through Quick Response Department. Add -Z6 for assembly of nuts and ferrules on the tube stub end.

BSPF Female Adapter For metric tube

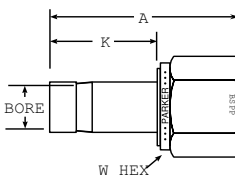
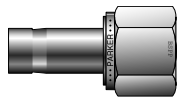

CPI™ PART NO.	A-LOK® PART NO.	INTER- CHANGES WITH	MILLIMETERS					
			TUBE O.D.	BSPP THREAD	A	K	W HEX	BORE
T2HG 3-1/8R	M3FA1/8R	3-MTA-7-2RP	3	1/8	28,6	13,5	14,0	1,8
T2HG 3-1/4R	M3FA1/4R	3-MTA-7-4RP	3	1/4	28,6	13,7	19,0	1,6
T2HG 4-1/8R	M4FA1/8R	4-MTA-7-2RP	4	1/8	29,4	14,3	14,0	2,0
T2HG 6-1/8R	M6FA1/8R	6-MTA-7-4RP	6	1/8	31,0	15,9	14,0	4,0
T2HG 6-1/4R	M6FA1/4R	6-MTA-7-4RP	6	1/4	37,3	15,9	19,0	4,0
T2HG 8-1/4R	M8FA1/4R	8-MTA-7-4RP	8	1/4	38,1	16,7	19,0	6,4
T2HG 10-1/4R	M10FA1/4R	10-MTA-7-4RP	10	1/4	38,9	17,5	19,0	7,5
T2HG 10-1/2R	M10FA1/2R	10-MTA-7-8RP	10	1/2	43,7	17,5	27,0	7,5
T2HG 12-3/8R	M12FA3/8R	12-MTA-7-6RP	12	3/8	44,5	23,0	22,0	9,1
T2HG 12-1/2R	M12FA1/2R	12-MTA-7-8RP	12	1/2	48,4	23,0	27,0	9,1
T2HG 16-1/2R	M16FA1/2R	16-MTA-7-8RP	16	1/2	50,0	24,6	27,0	12,7
T2HG 18-3/4R	M18FA3/4R	18-MTA-7-12RP	18	3/4	53,2	24,6	33,0	14,0
T2HG 20-3/4R	M20FA3/4R	20-MTA-7-12RP	20	3/4	54,0	25,4	33,0	15,1
T2HG 25-1R	M25FA1R	25-MTA-7-16RP	25	1	67,5	31,8	41,0	19,8

NOTE: Copper washer must be used for this design.

Dimensions for reference only, subject to change.

Tube stub is pre-grooved as standard. Generic (non-grooved) can be ordered through Quick Response Department. Add -Z6 for assembly of nuts and ferrules on the tube stub end.

Push-Lok to Tube Adapter For fractional tube

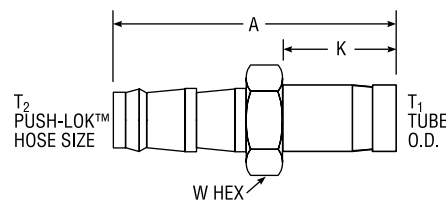
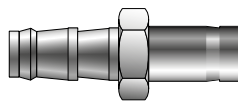

CPI™ PART NO.	A-LOK® PART NO.	INTER- CHANGES WITH	INCHES				
			T ₁ TUBE O.D.	T ₂ HOSE SIZE	A	K	W HEX
4-4 P2T2	4P2TU4	PB4-TA4	1/4	-4	1.80	.64	7/16
6-6 P2T2	6P2TU6	PB6-TA6	3/8	-6	2.02	.72	9/16
8-8 P2T2	8P2TU8	PB8-TA8	1/2	-8	2.42	.98	11/16

NOTE: Drawing does not show Push-Lok collar.

Dimensions for reference only, subject to change.

Tube stub is pre-grooved as standard. Generic (non-grooved) can be ordered through Quick Response Department. Add -Z6 for assembly of nuts and ferrules on the tube stub end.

Color Coding

For easy reference, table column headings are color indicated as follows:

fractional



metric



Port Connectors

Push-Lok to Male Adapter For fractional tube

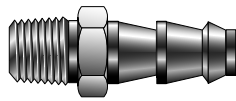

CPI™ PART NO.	A-LOK® PART NO.	INTER- CHANGES WITH	INCHES					
			T ₂ NPT PIPE THREAD	T ₁ HOSE SIZE	A	B	R	W HEX
4-4 P2HF	4-4 P2HF	PB4-PM4	1/4	-4	1.65	0.80	.56	9/16
6-6 P2HF	6-6 P2HF	PB6-PM6	3/8	-6	1.828	0.95	.56	11/16
8-8 P2HF	8-8 P2HF	PB8-PM8	1/2	-8	2.194	1.10	.75	7/8

NOTE: Drawing does not show Push-Lok collar.

Dimensions for reference only, subject to change.

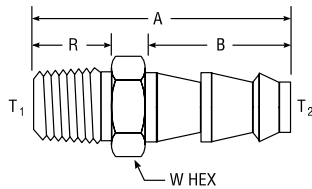

Push-Lok to CPI™ / A-LOK® For fractional tube

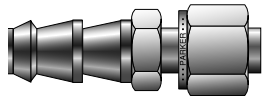

CPI™ PART NO.	A-LOK® PART NO.	INTER- CHANGES WITH	INCHES				
			T ₁ TUBE O.D.	T ₂ HOSE SIZE	A	K	W HEX
4-4 P2BZ6	4-4 P2LZ6	PB4-TA4	1/4	-4	1.77	0.72	7/16
6-6 P2BZ6	6-6 P2LZ6	PB6-TA6	3/8	-6	1.98	0.78	9/16
8-8 P2BZ6	8-8 P2LZ6	PB8-TA8	1/2	-8	2.42	1.03	11/16

NOTE: A dimension is typical finger-tight.

Dimensions for reference only, subject to change.

Drawing does not show Push-Lok collar. Assembly includes nut and ferrules.

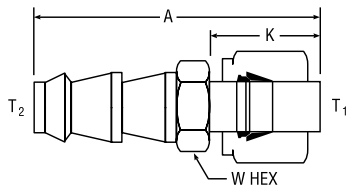

Push-Lok to Port Connector For fractional tube

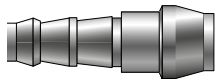

CPI™ PART NO.	A-LOK® PART NO.	INCHES			
		T ₁ HOSE SIZE	T ₂ PORT SIZE	A	B
4-6 ZPB2	4-6 ZPC2	-4	3/8	1.40	.80

NOTE: Drawing does not show Push-Lok collar and size 6 A-LOK® nut. Dimensions for reference only, subject to change.

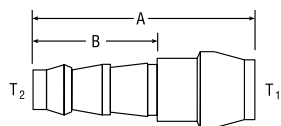

Port Connectors

Lapped Joint Tube Adapters For metric tube

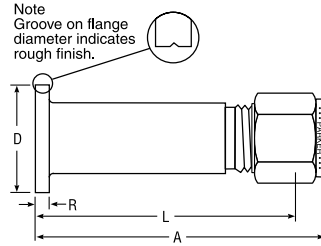
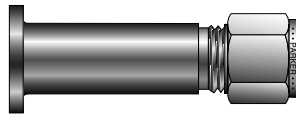

CPI™ PART NO.	A-LOK® PART NO.	INTER- CHANGES WITH	MILLIMETERS							
			TUBE O.D.	FLANGE SIZE	A	D	L	R	SURFACE FINISH	
LJFBZ10-5	M10LJF-5	10M0-1-0005	10	DN15(1/2"NB)	83,0	34,5	75,5	6,5	Smooth	3,2-6,3 Ra-
LJFBZ10-9	M10LJF-9	10M0-1-0006	10	DN15(1/2"NB)	83,0	34,5	75,5	6,5	Rough	6,3-12,5 Ra
LJFBZ12-5	M12LJF-5	-	12	DN15(1/2"NB)	85,0	34,5	75,4	6,5	Smooth	3,2-6,3 Ra-
LJFBZ12-9	M12LJF-9	-	12	DN15(1/2"NB)	85,0	34,5	75,4	6,5	Rough	6,3-12,5 Ra

NOTE: Groove on flange diameter indicates rough finish.

Dimensions for reference only, subject to change.

The lapped joint tube adaptor is a fitting designed to be used with a lap joint flange which enables a direct hook-up to the instrument tube from the process line.

The compression fitting is incorporated into the body of the adaptor thus the number of components needed for hook-up is reduced. It is therefore cost efficient as well as space saving.

The face of the fitting forms the gasket face of the flange and comes with either a smooth or serrated surface finish.

Adapters to suit other tube and flange sizes may be furnished upon request.

For the full line of Manifold Accessories, see Catalog 4190-FP-ACC.

Single/Double Ferrule Instrument Compression Fittings

DP Transmitter Calibration Adapters For fractional tube

Parker CPI™ /A-LOK® adapters connect directly to the bleed port of a differential pressure transmitter so that the calibration process can be simplified. Two sizes of adapters (1/4-28 Thd., 5/16-24 Thd.) are available to fit the vent ports of Rosemount, Honeywell, and Foxboro DP transmitters. Both adapters are available in 316SS.

TRANSMITTER TYPE	PARKER PART NO.	INTERCHANGES WITH
(1) Rosemount/Foxboro	4-2 ZH2LX-SS-D950373	-
(2) Honeywell	4-2 ZH2LX-SS-D940336	SS-400-1-0257
(3) Rosemount/Yokogawa	4-2 ZH2LX-SS-D030297	SS-400-1-0253
(4) ABB	4-2 ZH2LX-SS-D030249	-

STRAIGHT THREAD	INCHES									
	A	B	C	D	E	F	G	H	J	HEX
(1) 5/16-24	2.32	1.41	.70	2.03	.24	.60	.25	.06	.41	1/2
(2) 1/4-28	1.75	.80	.70	1.46	.47	.60	.20	.03	-	1/2
(3) 5/16-24	2.32	1.41	.70	2.03	.40	.60	.25	.05	.41	1/2
(4) 1/4-28	1.74	.74	.70	1.44	.30	.60	.18	.05	-	1/2

Dimensions for reference only, subject to change.

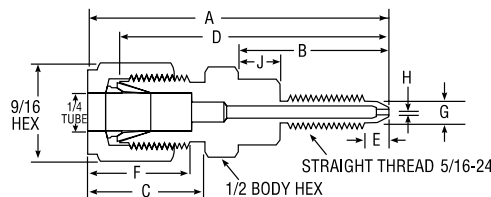
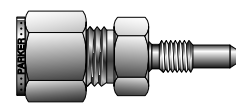
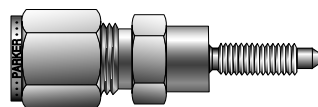

Calibration Adapter for
Rosemount/Foxboro DP Transmitters

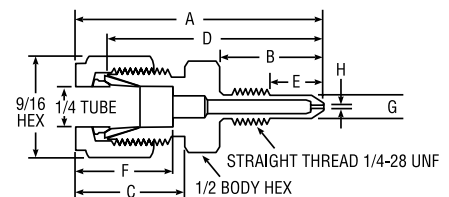

Calibration Adapter for
Honeywell DP Transmitters

Color Coding

For easy reference, table column headings are color indicated as follows:

fractional

metric

37° Flare (AN) to CPI™ / A-LOK®

Single/Double Ferrule Instrument Compression Fittings

37° Flare (AN) to CPI™ / A-LOK® For fractional tube

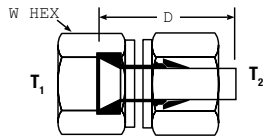
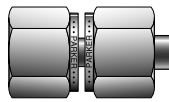

CPI™ PART NO.	A-LOK® PART NO.	INTER-CHANGES WITH	INCHES		
			TUBE O.D.	D	W HEX
2-2 X6HBZ6	2X6TU2	200-A-2 ANF	1/8	0.88	3/8
4-4 X6HBZ6	4X6TU4	400-A-4 ANF	1/4	0.96	9/16
6-6 X6HBZ6	6X6TU6	600-A-6 ANF	3/8	1.07	11/16
8-8 X6HBZ6	8X6TU8	810-A-8 ANF	1/2	1.37	7/8
12-12 X6HBZ6	12X6TU12	1210-A-12ANF	3/4	1.49	1-1/4
16-16 X6HBZ6	16X6TU16	1610-A-16ANF	1	1.80	1-1/2

Dimensions for reference only, subject to change.

37° Flare Connector For fractional tube

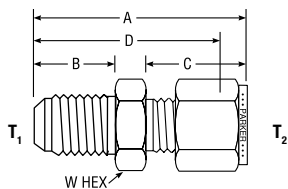
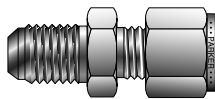

CPI™ PART NO.	A-LOK® PART NO.	INTER-CHANGES WITH	INCHES						
			FLARE END	TUBE O.D.	A	B	C	D	W HEX
2-1 XHBZ	2XASC1	100-6-2 AN	1/8	1/16	1.07	.45	0.43	.92	7/16
2-2 XHBZ	2XASC2	200-6-2 AN	1/8	1/8	1.28	.45	0.60	1.02	7/16
4-2 XHBZ	4XASC2	200-6-4 AN	1/4	1/8	1.39	.55	0.60	1.13	1/2
3-3 XHBZ	3XASC3	300-6-3 AN	3/16	3/16	1.32	.48	0.64	1.06	7/16
4-4 XHBZ	4XASC4	400-6-4 AN	1/4	1/4	1.48	.55	0.70	1.19	1/2
5-5 XHBZ	5XASC5	500-6-5 AN	5/16	5/16	1.52	.55	0.73	1.22	9/16
4-6 XHBZ	4XASC6	600-6-4 AN	1/4	3/8	1.56	.55	0.76	1.27	5/8
6-6 XHBZ	6XASC6	600-6-6 AN	3/8	3/8	1.56	.56	0.76	1.27	5/8
8-8 XHBZ	8XASC8	810-6-8 AN	1/2	1/2	1.81	.66	0.87	1.41	13/16
10-10 XHBZ	10XASC10	1010-6-10 AN	5/8	5/8	1.93	.76	0.87	1.53	15/16
12-12 XHBZ	12XASC12	1210-6-12 AN	3/4	3/4	2.11	.86	0.87	1.70	1-1/8
16-16 XHBZ	16XASC16	1610-6-16 AN	1	1	2.43	.91	1.05	1.94	1-3/8

NOTE: A and C dimensions are typical finger-tight.

Dimensions for reference only, subject to change.

37° Flare Bulkhead Connector For fractional tube

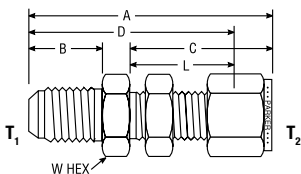
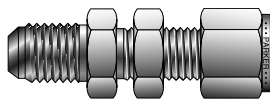

CPI™ PART NO.	A-LOK® PART NO.	INTER-CHANGES WITH	INCHES							
			FLARE END	TUBE O.D.	A	D	C	L	B	W HEX
2-2 XH2BZ	2XABC2	200-61-2 AN	1/8	1/8	1.91	1.65	1.23	0.97	.45	1/2
3-3 XH2BZ	3XABC3	300-61-3 AN	3/16	3/16	1.98	1.71	1.26	1.00	.48	9/16
4-2 XH2BZ	4XABC2	200-61-4 AN	1/4	1/8	2.04	1.78	1.23	0.97	.55	5/8
4-4 XH2BZ	4XABC4	400-61-4 AN	1/4	1/4	2.12	1.83	1.31	1.02	.55	5/8
5-5 XH2BZ	5XABC5	500-61-5 AN	5/16	5/16	2.21	1.92	1.41	1.12	.55	11/16
4-6 XH2BZ	4XABC6	600-61-4 AN	1/4	3/8	2.25	1.96	1.44	1.15	.55	3/4
6-6 XH2BZ	6XABC6	600-61-6 AN	3/8	3/8	2.25	1.96	1.44	1.15	.56	3/4
8-8 XH2BZ	8XABC8	810-61-8 AN	1/2	1/2	2.59	2.19	1.65	1.25	.66	15/16
10-10 XH2BZ	10XABC10	1010-61-10 AN	5/8	5/8	2.74	2.34	1.68	1.28	.76	1-1/16
12-12 XH2BZ	12XABC12	1210-61-12 AN	3/4	3/4	3.11	2.71	1.87	1.47	.86	1-3/16
16-16 XH2BZ	16XABC16	1610-61-16 AN	1	1	3.65	3.16	2.27	1.78	.91	1-9/16

NOTE: A and C dimensions are typical finger-tight.

Dimensions for reference only, subject to change.

For bulkhead hole drill size and maximum bulkhead thickness, see page 61, Part BC

Tube to O-Ring Seal

Introduction

BSPP / SAE Straight Thread Fittings Installation Procedure

1. Lubricate O-ring with a lubricant that is compatible with the system.
2. Screw fitting into the straight thread port until the metal back-up washer contacts the face of the port.
3. Position the fitting by backing it out no more than one turn.
4. Hold the fitting in position and tighten the locknut until the washer contacts the face of the port. (See torque chart.)

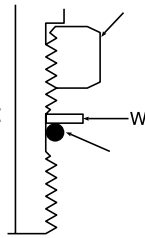

SAE

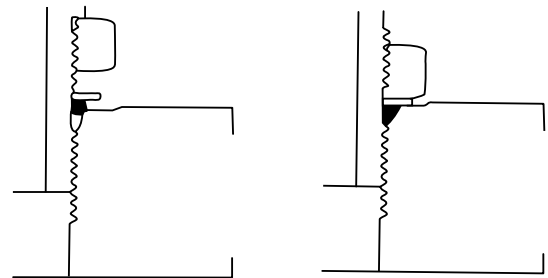

NOTE: WLN Lock Nuts are ordered separately by size and part number. Refer to page 106.

SIZE	STRAIGHT PORT		ADJUSTABLE PORT	
	TORQUE (IN-LBS)	(F.F.T.)	TORQUE (IN-LBS)	(F.F.T.)
4	245 ± 10	1.0 ± .25	200 ± 10	1.5 ± 25
6	630 ± 25	1.5 ± .25	400 ± 10	1.5 ± 25
8	1150 ± 50	1.5 ± .25	640 ± 10	1.5 ± 25
10	1550 ± 50	1.5 ± .25	1125 ± 50	1.5 ± 25
12	2050 ± 50	1.5 ± .25	1450 ± 50	1.5 ± 25
16	3000 ± 50	1.5 ± .25	2150 ± 50	1.5 ± 25
20	3400 ± 100	1.5 ± .25	2800 ± 100	2.0 ± 25
24	4500 ± 100	1.5 ± .25	3450 ± 100	2.0 ± 25

BSPP

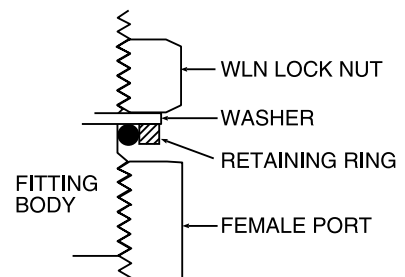

NOTES:

- Restrain fitting body on adjustables if necessary in installation.
- Values in charts are for assemblies with O-ring lubricated.
- Use upper limits of torque ranges for stainless steel fittings.

Face Seal O-Ring Fittings Installation Procedure

The O-ring requires a smooth, flat seating surface. This surface must be perpendicular to the axis of the threads.

1. Turn the O-ring seal fitting in the port until finger tight.
2. The “squeezing” effect on the O-ring can be felt during the last 1/4 turn.
3. Snug lightly with a wrench.

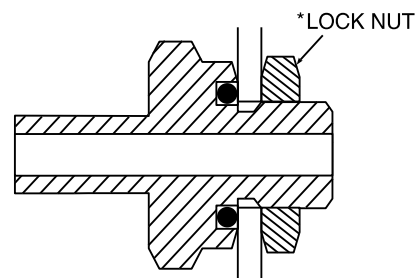

*Typical Application

The fitting can be adapted as a bulkhead fitting on thin wall tanks or vessels, eliminating welding, brazing or threading. Simply order the L5N locknut to take advantage of this option.

Notes:

Standard O-rings are nitrile material. For other O-rings, state material after the part number. L5N locknuts are ordered separately by size and part number. Refer to page 106.

PORT SIZE	STRAIGHT THREAD SIZE	STRAIGHT THREAD MACHINE LENGTH	L5N LOCKNUT THICKNESS	MAXIMUM TANK WALL THICKNESS
2	5/16-24	.297	.219	.078 = 5/64
3	3/8-24	.297	.219	.078 = 5/64
4	7/16-20	.360	.250	.109 = 7/65
5	1/2-20	.360	.250	.109 = 7/64
6	9/16-18	.391	.265	.125 = 1/8
8	3/4-16	.438	.312	.125 = 1/8
10	7/8-14	.500	.360	.140 = 9/64
12	1-1/16-12	.594	.406	.188 = 3/16
14	1-13/16-12	.594	.406	.188 = 3/16
16	1-5/16-12	.594	.406	.188 = 3/16

O-rings used with SAE/MS straight threads are nitrile. Other O-ring materials are available on request. Lubricate O-ring with a lubricant compatible with the system fluid, environment and O-ring material.

Tube to O-Ring Seal

**Male Connector to SAE
Straight Thread**
For fractional tube

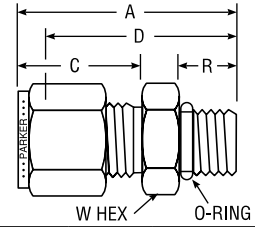
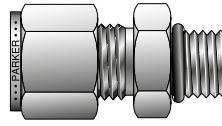

Single/Double Ferrule
Instrument Compression
Fittings

CPT™ PART NO.	A-LOK® PART NO.	INTER- CHANGES WITH	INCHES							O-RING AS UNIFORM DASH NO.
			TUBE O.D.	STRAIGHT THREAD SIZE	A	C	D	R	W HEX	
1-2 ZHBA	1M1SC2	100-1-2ST	1/16	5/16-24	0.92	0.43	0.77	.30	7/16	3-902
2-2 ZHBA	2M1SC2	200-1-2ST	1/8	5/16-24	1.18	0.60	0.92	.30	7/16	3-902
2-6 ZHBA	2M1SC6	200-1-6ST	1/8	9/16-18	1.35	0.60	1.06	.39	11/16	3-906
3-3 ZHBA	3M1SC3	300-1-3ST	3/16	3/8-24	1.20	0.64	0.94	.30	1/2	3-903
4-4 ZHBA	4M1SC4	400-1-4ST	1/4	7/16-20	1.34	0.70	1.05	.36	9/16	3-904
4-6 ZHBA	4M1SC6	400-1-6ST	1/4	9/16-18	1.40	0.70	1.11	.39	11/16	3-906
4-8 ZHBA	4M1SC8	400-1-8ST	1/4	3/4-16	1.48	0.70	1.19	.44	7/8	3-908
4-10 ZHBA	4M1SC10	400-1-10ST	1/4	7/8-14	1.60	0.70	1.31	.50	1	3-910
5-5 ZHBA	5M1SC5	500-1-5ST	5/16	1/2-20	1.37	0.73	1.08	.36	5/8	3-905
6-4 ZHBA	6M1SC4	600-1-4ST	3/8	7/16-20	1.40	0.76	1.11	.36	5/8	3-904
6-6 ZHBA	6M1SC6	600-1-6ST	3/8	9/16-18	1.46	0.76	1.17	.39	11/16	3-906
6-8 ZHBA	6M1SC8	600-1-8ST	3/8	3/4-16	1.54	0.76	1.25	.44	7/8	3-908
6-10 ZHBA	6M1SC10	600-1-10ST	3/8	7/8-14	1.67	0.76	1.38	.50	1.00	3-910
8-6 ZHBA	8M1SC6	810-1-6ST	1/2	9/16-18	1.54	0.87	1.14	.39	7/8	3-906
8-8 ZHBA	8M1SC8	810-1-8ST	1/2	3/4-16	1.65	0.87	1.25	.44	7/8	3-908
8-12 ZHBA	8M1SC12	810-1-12ST	1/2	1-1/16-12	1.93	0.87	1.53	.59	1-1/4	3-912
10-10 ZHBA	10M1SC10	1010-1-10ST	5/8	7/8-14	1.78	0.87	1.38	.50	1	3-910
12-10 ZHBA	12M1SC10	1210-1-10ST	3/4	7/8-14	1.68	0.87	1.28	.50	1-1/8	3-910
12-12 ZHBA	12M1SC12	1210-1-12ST	3/4	1-1/16-12	1.93	0.87	1.53	.59	1-1/4	3-912
12-14 ZHBA	14M1SC14	1410-1-14ST	7/8	1-3/16-12	1.93	0.87	1.53	.59	1-3/8	3-914
16-12 ZHBA	16M1SC12	1610-1-12ST	1	1-1/16-12	2.12	1.05	1.63	.59	1-3/8	3-912
16-16 ZHBA	16M1SC16	1610-1-16ST	1	1-5/16-12	2.15	1.04	1.66	.59	1-1/2	3-916
20-20 ZHBA	20M1SC20	2010-1-20ST	1-1/4	1-5/8-12	2.59	1.52	1.82	.59	1-7/8	3-920
24-24 ZHBA	24M1SC24	2410-1-24ST	1-1/2	1-7/8-12	3.05	1.77	1.99	.59	2-1/8	3-924
32-32 ZHBA	32M1SC32	3210-1-32ST	2	2-1/2-12	4.00	2.47	2.53	.59	2-3/4	3-932

NOTE: A and C dimensions are typical finger-tight.

Dimensions for reference only, subject to change.

For use with SAE J.1926/1 port can also be used with MS-16142 port.
Sizes 20, 24, 32 require additional lubrication prior to assembly.

Parts are supplied with nitrile o-rings as standard. For Fluorocarbon o-rings, add the suffix "-VO". Other o-rings available upon request.

Color Coding

For easy reference, table column headings are color indicated as follows:

fractional



metric



Tube to O-Ring Seal

Male SAE Straight Thread Elbow For fractional tube

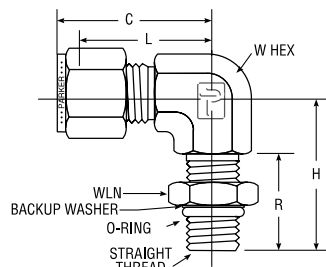
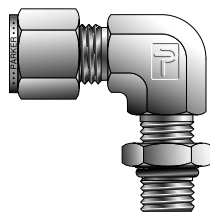

CPI™ PART NO.	A-LOK® PART NO.	INTER- CHANGES WITH	INCHES								O-RING ARP UNIFORM DASH NO.
			TUBE O.D.	STRAIGHT THREAD SIZE	C	H	L	R	W HEX		
4-4 C5BZ	4M5SEL4	400-2-4ST	1/4	7/16-20	1.12	1.18	0.83	0.83	9/16	3-904	
6-6 C5BZ	6M5SEL6	600-2-6ST	3/8	9/16-18	1.26	1.27	0.97	0.84	9/16	3-906	
8-8 C5BZ	8M5SEL8	810-2-8ST	1/2	3/4-16	1.48	1.48	1.08	0.97	3/4	3-908	
12-12 C5BZ	12M5SEL12	1210-2-12ST	3/4	1-1/16-12	1.63	1.92	1.23	1.28	1-1/16	3-912	
16-16 C5BZ	16M5SEL16	1610-2-16ST	1	1-5/16-12	1.91	2.11	1.42	1.28	1-5/16	3-916	
24-24 C5BZ	24M5SEL24	2410-2-24ST	1-1/2	1-7/8-12	3.47	2.33	2.00	1.16	1-7/8	3-924	

NOTE: C dimension is typical finger-tight.

Dimensions for reference only, subject to change.

Size 24 requires additional lubrication prior to assembly.

Parts are supplied with nitrile o-rings as standard. For Fluorocarbon o-rings, add the suffix "-VO". Other o-rings available upon request.

BSPB Male Elbow (Positionable) For fractional tube

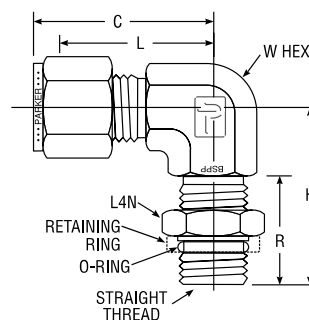
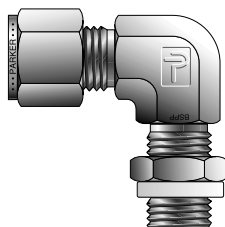

CPI™ PART NO.	A-LOK® PART NO.	INTER- CHANGES WITH	INCHES						
			TUBE O.D.	BSPB THREAD	C	H	L	R	W HEX
4-2R CBZ	4MSEL2R	400-2-2PR	1/4	1/8-28	1.06	1.04	0.77	0.81	9/16
4-4R CBZ	4MSEL4R	400-2-4PR	1/4	1/4-19	1.14	1.27	0.85	0.83	9/16
6-4R CBZ	6MSEL4R	600-2-4PR	3/8	1/4-19	1.20	1.27	0.85	0.83	9/16
6-6R CBZ	6MSEL6R	600-2-6PR	3/8	3/8-19	1.31	1.46	1.02	0.83	3/4
8-8R CBZ	8MSEL4R	810-2-4PR	1/2	1/4-19	1.50	1.38	1.10	0.83	7/8
8-6R CBZ	8MSEL6R	810-2-6PR	1/2	3/8-19	1.50	1.46	1.10	0.85	7/8
8-8R CBZ	8MSEL8R	810-2-8PR	1/2	1/2-14	1.50	1.71	1.10	1.09	7/8
10-10R CBZ	10MSEL8R	1010-2-8PR	5/8	1/2-14	1.50	1.81	1.10	1.09	1-1/16
12-8R CBZ	12MSEL8R	1210-2-8PR	3/4	1/2-14	1.57	1.81	1.17	1.09	1-1/16
12-12R CBZ	12MSEL12R	1210-2-12PR	3/4	3/4-14	1.57	1.92	1.17	1.20	1-1/16
16-12R CBZ	16MSEL12R	1610-2-12PR	1	3/4-14	1.93	2.11	1.45	1.20	1-5/16
16-16R CBZ	16MSEL16R	1610-2-16PR	1	1-11	1.93	2.11	1.45	1.20	1-5/16

NOTE: C dimension is typical finger-tight.

Dimensions for reference only, subject to change.

Connects fractional tube to female ISO parallel thread.

Parts are supplied with nitrile o-rings as standard. For Fluorocarbon o-rings, add the suffix "-VO". Other o-rings available upon request.

Color Coding

For easy reference, table column headings are color indicated as follows:

fractional



metric



Tube to O-Ring Seal

Male Run Tee SAE Straight Thread For fractional tube

Single/Double Ferrule
Instrument Compression
Fittings

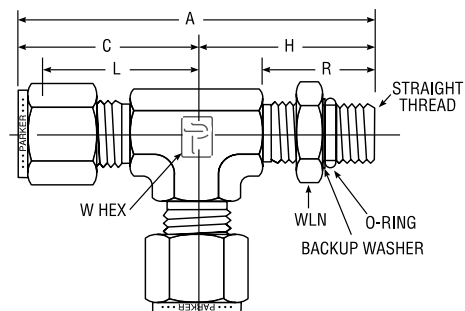
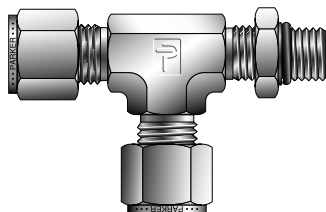

CPI™ PART NO.	A-LOK® PART NO.	INTER- CHANGES WITH	INCHES							O-RING ARP UNIFORM DASH NO.	
			TUBE O.D.	TRAIGHT THREAD SIZE	A	C	H	L	R		W HEX
4-4-4 R5BZ	4M5RT4	400-3TST	1/4	7/16-20	2.24	1.12	1.18	0.83	0.83	7/16	3-904
6-6-6 R5BZ	6M5RT6	600-3TST	3/8	9/16-18	2.53	1.26	1.27	0.97	0.84	9/16	3-906
8-8-8 R5BZ	8M5RT8	810-3TST	1/2	3/4-16	2.97	1.48	1.48	1.08	0.97	3/4	3-908
12-12-12 R5BZ	12M5RT12	1210-3TST	3/4	1-1/16-12	3.55	1.63	1.92	1.23	1.28	1-1/16	3-912
16-16-16 R5BZ	16M5RT16	1610-3TST	1	1-5/16-12	3.74	1.87	2.11	1.38	1.28	1-5/16	3-916

NOTE: A and C dimensions are typical finger-tight.

Dimensions for reference only, subject to change.

Parts are supplied with nitrile o-rings as standard. For Fluorocarbon o-rings, add the suffix "-VO". Other o-rings available upon request.

BSPP Male Run Tee (Positionable) For fractional tube

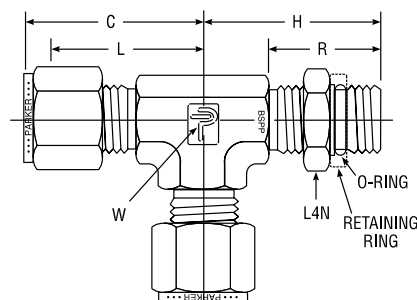
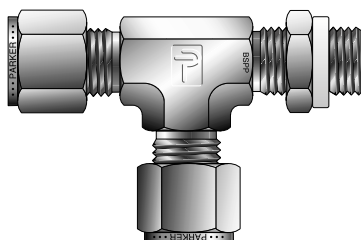

CPI™ PART NO.	A-LOK® PART NO.	INTER- CHANGES WITH	INCHES						
			TUBE O.D.	BSPP THREAD	C	H	L	R	W HEX
4-2R-4 RBZ	4MRT2R	400-3TRT	1/4	1/8-28	1.06	1.04	0.77	0.81	9/16
4-4R-4 RBZ	4MRT4R	400-3-4TRT	1/4	1/4-19	1.14	1.27	0.85	0.83	9/16
6-6R-6 RBZ	6MRT6R	600-3TRT	3/8	3/8-19	1.20	1.27	0.91	0.83	9/16
8-6R-8 RBZ	8MRT6R	810-3TRT	1/2	3/8-19	1.50	1.46	1.10	0.85	7/8
8-8R-8 RBZ	8MRT8R	810-3-8TRT	1/2	1/2-14	1.50	1.71	1.10	1.09	7/8
10-8R-10 RBZ	10MRT8R	1010-3TRT	5/8	1/2-14	1.50	1.81	1.10	1.09	1-1/16
12-8R-12 RBZ	12MRT8R	1210-3-8TRT	3/4	1/2-14	1.57	1.81	1.17	1.09	1-1/16
12-12R-12 RBZ	12MRT12R	1210-3TRT	3/4	3/4-14	1.57	1.92	1.17	1.20	1-1/16
16-16R-16 RBZ	16MRT16R	1610-3TRT	1	1-11	1.93	2.11	1.45	1.20	1-5/16

NOTE: C dimension is typical finger-tight.

Dimensions for reference only, subject to change.

Parts are supplied with nitrile o-rings as standard. For Fluorocarbon o-rings, add the suffix "-VO". Other o-rings available upon request.

Tube to O-Ring Seal

Male Branch Tee SAE Straight Thread For fractional tube

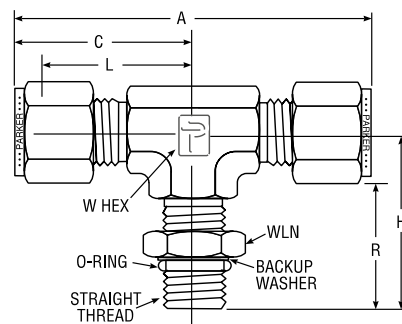
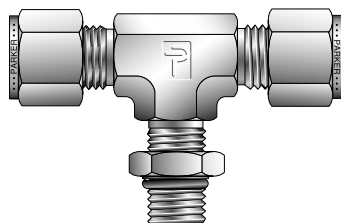

CPIT™ PART NO.	A-LOK® PART NO.	INTER- CHANGES WITH	INCHES								O-RING ARP UNIFORM DASH NO.
			TUBE O.D.	STRAIGHT THREAD SIZE	A	C	H	L	R	W HEX	
4-4-4 S5BZ	4M5BT4	400-3TTS	1/4	7/16-20	2.24	1.19	1.19	0.81	0.81	7/16	3-904
6-6-6 S5BZ	6M5BT6	600-3TTS	3/8	9/16-18	2.52	1.26	1.27	0.97	0.84	9/16	3-906
8-8-8 S5BZ	8M5BT8	810-3TTS	1/2	3/4-16	2.96	1.48	1.48	1.08	0.97	3/4	3-908
12-12-12 S5BZ	12M5BT12	1210-3TTS	3/4	1-1/16-12	3.26	1.63	1.92	1.23	1.28	1-1/16	3-912
16-16-16 S5BZ	16M5BT16	1610-3TTS	1	1-5/16-12	3.74	1.87	2.11	1.38	1.28	1-5/16	3-916

NOTE: A and C dimensions are typical finger-tight.

Dimensions for reference only, subject to change.

Parts are supplied with nitrile o-rings as standard. For Fluorocarbon o-rings, add the suffix "-VO". Other o-rings available upon request.

BSPB Male Branch Tee (Positionable) For fractional tube

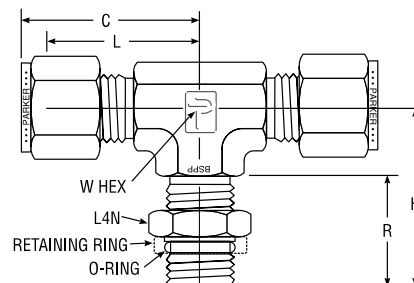
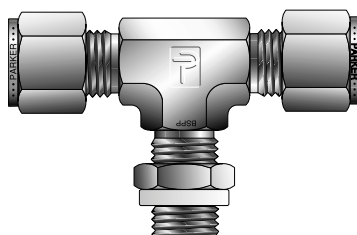

CPIT™ PART NO.	A-LOK® PART NO.	INTER- CHANGES WITH	INCHES						
			TUBE O.D.	BSPP THREAD	C	H	L	R	W HEX
4-4-2R SBZ	4MBT2R	400-3TTR	1/4	1/8-28	1.06	1.25	0.77	0.81	9/16
4-4-4R SBZ	4MBT4R	400-3-4TTR	1/4	1/4-19	1.14	1.27	0.85	0.83	9/16
6-6-4R SBZ	6MBT4R	600-3TTR	3/8	1/4-19	1.20	1.27	0.91	0.83	9/16
8-8-6R SBZ	8MBT6R	810-3TTR	1/2	3/8-19	1.50	1.36	1.10	0.85	7/8
8-8-8R SBZ	8MBT8R	810-3-8TTR	1/2	1/2-14	1.50	1.71	1.10	1.09	7/8
10-10-8R SBZ	10MBT8R	1010-3TTR	5/8	1/2-14	1.50	1.81	1.10	1.09	1-1/16
12-12-8R SBZ	12MBT8R	1210-3-8TTR	3/4	1/2-14	1.57	1.81	1.17	1.09	1-1/16
12-12-12R SBZ	12MBT12R	1210-3-TTR	3/4	3/4-14	1.57	1.92	1.17	1.20	1-1/16
16-16-16R SBZ	16MBT16R	1610-3TTR	1	1-11	1.94	2.11	1.45	1.20	1-5/16

NOTE: C dimension is typical finger-tight.

Dimensions for reference only, subject to change.

Connects fractional tube to female ISO parallel thread.

Parts are supplied with nitrile o-rings as standard. For Fluorocarbon o-rings, add the suffix "-VO". Other o-rings available upon request.

Color Coding

For easy reference, table column headings are color indicated as follows:

fractional

metric

Single/Double Ferrule
Instrument Compression
Fittings

Tube to O-Ring Seal

Long Male Connector SAE/MS Straight Thread For fractional tube

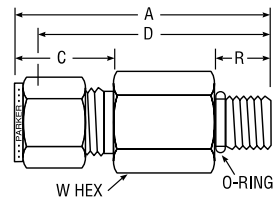
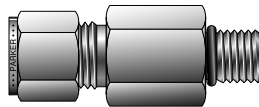

CPI™ PART NO.	A-LOK® PART NO.	INTER- CHANGES WITH	INCHES								ST O-RING UNIFORM SIZE NO.
			T TUBE O.D.	S-SAE/MS THREAD SIZE	A	R	C	D	E MIN. OPENING	W HEX	
4-4 ZH3BA	4-4 ZH3LA	400-1L-4ST	1/4	7/16-20	2.26	.36	0.70	1.97	.19	9/16	-904
6-6 ZH3BA	6-6 ZH3LA	600-1L-6ST	3/8	9/16-18	2.48	.39	0.76	2.19	.28	11/16	-906
8-8 ZH3BA	8-8 ZH3LA	810-1L-8ST	1/2	3/4-16	3.01	.44	0.86	2.58	.41	7/8	-908
12-12 ZH3BA	12-12 ZH3LA	1210-1L-12ST	3/4	1-1/16-12	3.88	.59	0.86	3.48	.62	1-1/4	-912
16-16 ZH3BA	16-16 ZH3LA	1610-1L-16ST	1	1-5/16-12	4.34	.59	1.04	3.86	.88	1-1/2	-916

NOTE: A and C dimensions are typical finger-tight.

Dimensions for reference only, subject to change.

Parts are supplied with nitrile o-rings as standard. For Fluorocarbon o-rings, add the suffix "-VO". Other o-rings available upon request.

45° Positionable Male Elbow SAE/MS Straight Thread For fractional tube

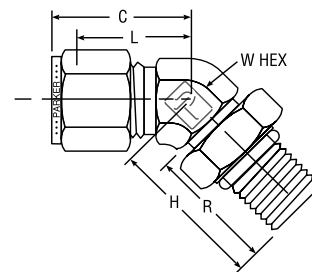
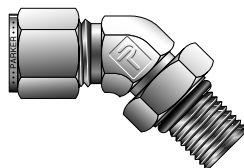

CPI™ PART NO.	A-LOK® PART NO.	INTER- CHANGES WITH	INCHES							O-RING UNIFORM DASH NO.
			STRAIGHT TUBE O.D.	THREAD SIZE	C	H	L	R	W HEX	
4-4 V5BZ	4M5VEL4	400-5-4ST	1/4	7/16-20	0.93	1.02	0.65	0.75	7/16	3-904
6-6 V5BZ	6M5VEL6	600-5-6ST	3/8	9/16-18	1.01	1.27	0.72	0.77	9/16	3-906
8-8 V5BZ	8M5VEL8	810-5-8ST	1/2	3/4-16	1.15	1.48	0.75	0.88	3/4	3-908
12-12 V5BZ	12M5VEL12	1210-5-12ST	3/4	1-1/16-12	1.63	1.92	1.23	1.16	1-1/16	3-912
16-16 V5BZ	16M5VEL16	1610-5-16ST	1	1-5/16-12	1.87	2.11	1.39	1.16	1-5/16	3-916

NOTE: C dimension is typical finger-tight.

Dimensions for reference only, subject to change.

• Adapts to SAE J1926 straight thread boss and MS16142 boss.

Parts are supplied with nitrile o-rings as standard. For Fluorocarbon o-rings, add the suffix "-VO". Other o-rings available upon request.

Tube to O-Ring Seal

Male Connector to O-Ring Straight Thread For fractional tube

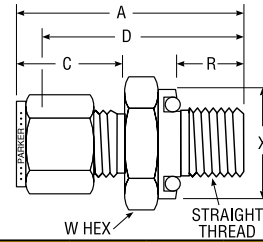
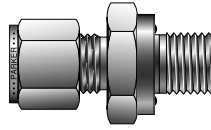

CPI™ PART NO.	A-LOK® PART NO.	INTER- CHANGES WITH	INCHES								O-RING ARP UNIFORM DASH NO.
			TUBE O.D.	STRAIGHT THREAD SIZE	A	C	D	R	X DIA.	W HEX	
1-2 ZHBA5	1M2SC2	100-1-OR	1/16	5/16-24	1.06	0.43	0.91	.34	.55	9/16	2-011
2-2 ZHBA5	2M2SC2	200-1-OR	1/8	5/16-24	1.29	0.60	1.03	.34	.55	9/16	2-011
3-3 ZHBA5	3M2SC3	300-1-OR	3/16	3/8-24	1.35	0.64	1.09	.38	.62	5/8	2-012
4-4 ZHBA5	4M2SC4	400-1-OR	1/4	7/16-20	1.51	0.70	1.22	.41	.74	3/4	2-111
5-5 ZHBA5	5M2SC5	500-1-OR	5/16	1/2-20	1.61	0.73	1.31	.44	.86	7/8	2-112
6-6 ZHBA5	6M2SC6	600-1-OR	3/8	9/16-18	1.67	0.76	1.38	.44	.93	15/16	2-113
8-8 ZHBA5	8M2SC8	810-1-OR	1/2	3/4-16	1.81	0.87	1.41	.47	1.12	1-1/8	2-116
10-10 ZHBA5	10M2SC10	1010-1-OR	5/8	7/8-14	1.90	0.87	1.50	.47	1.30	1-3/8	2-212
12-12 ZHBA5	12M2SC12	1210-1-OR	3/4	1-1/16-12	2.06	0.87	1.66	.56	1.49	1-1/2	2-215
14-12 ZHBA5	14M2SC12	1410-1-OR	7/8	1-1/16-12	2.06	0.87	1.66	.56	1.49	1-1/2	2-215
16-16 ZHBA5	16M2SC16	1610-1-OR	1	1-5/16-12	2.30	1.05	1.81	.56	1.74	1-3/4	2-219

NOTE: A and C dimensions are typical finger-tight.

Dimensions for reference only, subject to change.

Parts are supplied with nitrile o-rings as standard. For Fluorocarbon o-rings, add the suffix "-VO". Other o-rings available upon request.

Male Connector to O-Ring Pipe Thread For fractional tube

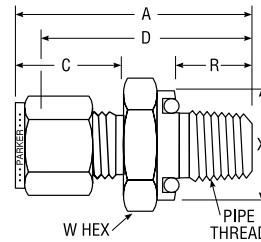
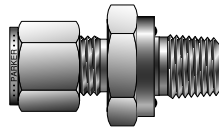

CPI™ PART NO.	A-LOK® PART NO.	INTER- CHANGES WITH	INCHES								O-RING ARP UNIFORM DASH NO.
			TUBE O.D.	NPT PIPE SIZE	A	C	D	R	X DIA.	W HEX	
1-2 ZHBF5	1M3SC2	100-1-2-OR	1/16	1/8	1.12	0.43	0.97	.28	.74	3/4	2-111
2-2 ZHBF5	2M3SC2	200-1-2-OR	1/8	1/8	1.29	0.60	1.03	.28	.74	3/4	2-111
2-4 ZHBF5	2M3SC4	200-1-4-OR	1/8	1/4	1.43	0.60	1.17	.38	.93	15/16	2-113
3-2 ZHBF5	3M3SC2	300-1-2-OR	3/16	1/8	1.32	0.64	1.06	.28	.74	3/4	2-111
3-4 ZHBF5	3M3SC4	300-1-4-OR	3/16	1/4	1.46	0.64	1.20	.38	.93	15/16	2-113
4-2 ZHBF5	4M3SC2	400-1-2-OR	1/4	1/8	1.38	0.70	1.09	.28	.74	3/4	2-111
4-4 ZHBF5	4M3SC4	400-1-4-OR	1/4	1/4	1.51	0.70	1.22	.38	.93	15/16	2-113
4-6 ZHBF5	4M3SC6	400-1-6-OR	1/4	3/8	1.57	0.70	1.28	.41	1.12	1-1/8	2-116
5-2 ZHBF5	5M3SC2	500-1-2-OR	5/16	1/8	1.43	0.73	1.13	.28	.74	3/4	2-111
5-4 ZHBF5	5M3SC4	500-1-4-OR	5/16	1/4	1.46	0.73	1.25	.38	.93	15/16	2-113
6-2 ZHBF5	6M3SC2	600-1-2-OR	3/8	1/8	1.45	0.76	1.16	.28	.74	3/4	2-111
6-4 ZHBF5	6M3SC4	600-1-4-OR	3/8	1/4	1.57	0.76	1.28	.38	.93	15/16	2-113
6-6 ZHBF5	6M3SC6	600-1-6-OR	3/8	3/8	1.63	0.76	1.34	.41	1.12	1-1/8	2-116
6-8 ZHBF5	6M3SC8	600-1-8-OR	3/8	1/2	1.85	0.76	1.56	.53	1.30	1-3/8	2-212
8-4 ZHBF5	8M3SC4	810-1-4-OR	1/2	1/4	1.68	0.87	1.28	.38	.93	15/16	2-113
8-6 ZHBF5	8M3SC6	810-1-6-OR	1/2	3/8	1.76	0.87	1.36	.41	1.12	1-1/8	2-116
8-8 ZHBF5	8M3SC8	810-1-8-OR	1/2	1/2	1.98	0.87	1.58	.53	1.30	1-3/8	2-212
10-8 ZHBF5	10M3SC8	1010-1-8-OR	5/8	1/2	1.96	0.87	1.56	.53	1.30	1-3/8	2-212
10-12 ZHBF5	10M3SC12	1010-1-8-OR	5/8	3/4	2.06	0.87	1.66	.56	1.49	1-1/2	2-215
12-8 ZHBF5	12M3SC8	1210-1-8-OR	3/4	1/2	1.98	0.87	1.58	.53	1.30	1-3/8	2-212
12-12 ZHBF5	12M3SC12	1210-1-12-OR	3/4	3/4	2.06	0.87	1.66	.56	1.49	1-1/2	2-215
16-12 ZHBF5	16M3SC12	1610-1-12-OR	1	3/4	2.24	1.05	1.75	.56	1.49	1-1/2	2-215
16-16 ZHBF5	16M3SC16	1610-1-16-OR	1	1	2.40	1.05	1.91	.66	1.74	1-3/4	2-219

NOTE: A and C dimensions are typical finger-tight.

Dimensions for reference only, subject to change.

Parts are supplied with nitrile o-rings as standard. For Fluorocarbon o-rings, add the suffix "-VO". Other o-rings available upon request.

Single/Double Ferrule
Instrument Compression
Fittings

Tube to O-Ring Seal

Tube End to O-Ring Straight Thread For fractional tube

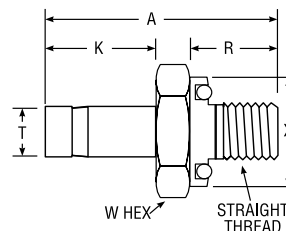
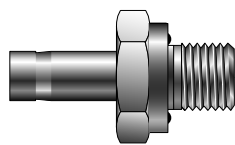

CPI™ PART NO.	A-LOK® PART NO.	INTER- CHANGES WITH	INCHES							O-RING ARP UNIFORM DASH NO.
			T TUBE O.D.	SAE STRAIGHT THREAD	A	K	R	X DIA.	W HEX	
2-2 T2HOA5	2M2TU2	2-TA-OR-ST	1/8	5/16-24	1.22	0.53	.34	0.55	9/16	2-011
3-3 T2HOA5	3M2TU3	3-TA-OR-ST	3/16	3/8-24	1.38	0.56	.38	0.62	5/8	2-012
4-4 T2HOA5	4M2TU4	4-TA-OR-ST	1/4	7/16-20	1.55	0.63	.41	0.74	3/4	2-111
5-5 T2HOA5	5M2TU5	5-TA-OR-ST	5/16	1/2-20	1.64	0.66	.44	0.86	7/8	2-112
6-6 T2HOA5	6M2TU6	6-TA-OR-ST	3/8	9/16-18	1.70	0.69	.47	0.93	15/16	2-113
8-8 T2HOA5	8M2TU8	8-TA-OR-ST	1/2	3/4-16	1.95	0.91	.47	1.12	1-1/8	2-116
10-10 T2HOA5	10M2TU10	10-TA-OR-ST	5/8	7/8-14	2.12	0.97	.47	1.30	1-3/8	2-212
12-12 T2HOA5	12M2TU12	12-TA-OR-ST	3/4	1-1/16-12	2.16	0.97	.56	1.49	1-1/2	2-215
16-16 T2HOA5	16M2TU16	16-TA-OR-ST	1	1-5/16-12	2.47	1.22	.56	1.74	1-3/4	2-219

NOTE: Add -Z6 for assembly of nuts and ferrules on the tube stub end.

Dimensions for reference only, subject to change.

Parts are supplied with nitrile o-rings as standard. For Fluorocarbon o-rings, add the suffix "-VO". Other o-rings available upon request.

Tube End to O-Ring Pipe Thread For fractional tube

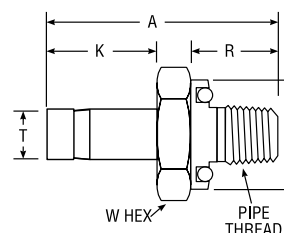
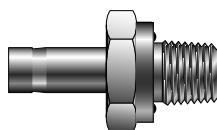

CPI™ PART NO.	A-LOK® PART NO.	INTER- CHANGES WITH	INCHES							O-RING ARP UNIFORM DASH NO.
			T TUBE O.D.	NPT PIPE THREAD	A	K	R	X DIA.	W HEX	
1-2 T2HOF5	1M3TU2	1-TA-1-20R	1/16	1/8	1.03	0.34	.28	0.74	3/4	2-111
4-2 T2HOF5	4M3TU2	4-TA-1-20R	1/4	1/8	1.31	0.63	.28	0.74	3/4	2-111
4-4 T2HOF5	4M3TU4	4-TA-1-40R	1/4	1/4	1.44	0.63	.38	0.93	15/16	2-113
4-6 T2HOF5	4M3TU6	4-TA-1-60R	1/4	3/8	1.50	0.63	.41	1.12	1-1/8	2-116
5-2 T2HOF5	5M3TU2	5-TA-1-20R	5/16	1/8	1.34	0.66	.28	0.74	3/4	2-111
5-4 T2HOF5	5M3TU4	5-TA-1-40R	5/16	1/4	1.47	0.66	.38	0.93	15/16	2-113
6-2 T2HOF5	6M3TU2	6-TA-1-20R	3/8	1/8	1.38	0.69	.28	0.74	3/4	2-111
6-4 T2HOF5	6M3TU4	6-TA-1-40R	3/8	1/4	1.50	0.69	.38	0.93	15/16	2-113
6-6 T2HOF5	6M3TU6	6-TA-1-60R	3/8	3/8	1.59	0.69	.41	1.12	1-1/8	2-116
8-6 T2HOF5	8M3TU6	8-TA-1-60R	1/2	3/8	1.78	0.91	.41	1.12	1-1/8	2-116
10-8 T2HOF5	10M3TU8	10-TA-1-80R	5/8	1/2	2.14	0.97	.53	1.30	1-3/8	2-212
12-12 T2HOF5	12M3TU12	12-TA-1-120R	3/4	3/4	2.16	0.97	.56	1.49	1-1/2	2-215
16-16 T2HOF5	16M3TU16	16-TA-1-160R	1	1	2.56	1.22	.66	1.65	1-3/4	2-219

NOTE: Add -Z6 for assembly of nuts and ferrules on the tube stub end.

Dimensions for reference only, subject to change.

Parts are supplied with nitrile o-rings as standard. For Fluorocarbon o-rings, add the suffix "-VO". Other o-rings available upon request.

Color Coding

For easy reference, table column headings are color indicated as follows:

fractional



metric



Tube to O-Ring Seal

NPT Thread to SAE Straight Thread Adapter For fractional tube

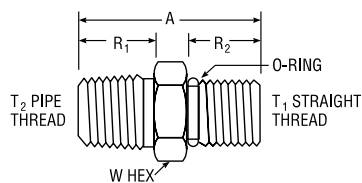
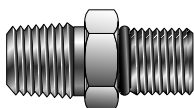

CPI™ PART NO.	A-LOK® PART NO.	INTER- CHANGES WITH	INCHES						O-RING AS UNIFORM DASH NO.
			T ₂ NPT THREAD	T ₁ SAE STRAIGHT THREAD	A	R1	R2	W HEX	
4-4 FHOA	4-4 FHOA	4-SAE-1-4	1/4-18	7/16-20	1.20	.56	.36	9/16	3-904
6-6 FHOA	6-6 FHOA	6-SAE-1-6	3/8-18	9/16-18	1.26	.56	.39	11/16	3-906
8-8 FHOA	8-8 FHOA	8-SAE-1-8	1/2-14	3/4-16	1.53	.75	.44	7/8	3-908
12-12 FHOA	12-12 FHOA	12-SAE-1-12	3/4-14	1-1/16-12	1.75	.75	.59	1-1/4	3-912
16-16 FHOA	16-16 FHOA	16-SAE-1-16	1-11-1/2	1-5/16-12	2.00	.94	.59	1-1/2	3-916

NOTE: A and C dimensions are typical finger-tight.

Dimensions for reference only, subject to change.

For use with SAE J.1926/1 port can also be used with MS-16142 port.

Parts are supplied with nitrile o-rings as standard. For Fluorocarbon o-rings, add the suffix "-VO".
Other o-rings available upon request.

Bulkhead to Conversion Adapter For fractional tube

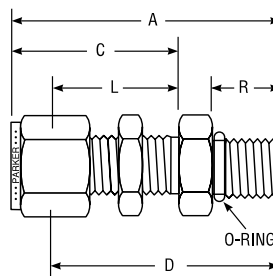
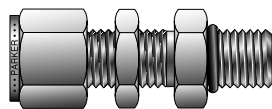

CPI™ PART NO.	A-LOK® PART NO.	INTER- CHANGES WITH	INCHES										MAXIMUM BULKHEAD THICKNESS
			TUBE O.D.	STRAIGHT THREAD SIZE	A	C	D	R	L	W HEX	BULKHEAD HOLE DRILL SIZE		
4-6 AH2BZ	4-6 AH2LZ	400-11-6ST	1/4	9/16-18	1.74	1.17	1.45	.39	.88	3/4	37/64	9/16	
6-6 AH2BZ	6-6 AH2LZ	600-11-6ST	3/8	9/16-18	1.81	1.24	1.52	.39	.94	3/4	37/64	9/16	

NOTE: A and C dimensions are typical finger-tight.

Dimensions for reference only, subject to change.

For use with SAE J.1926/1 port can also be used with MS-16142 port.

Parts are supplied with nitrile o-rings as standard. For Fluorocarbon o-rings, add the suffix "-VO".
Other o-rings available upon request.

Color Coding

For easy reference, table column headings are color indicated as follows:

fractional

metric



Tube to Welded Systems

General

The weld used in joining a tube to a socket weld tube fitting is like any other type of “tee” weld. The root (i.e., the point of intersection of the outside of the tube and annular end area of the fitting) must be included in the weld zone.

Careful welding procedures are normally followed to assure that this root area is included in the weld. If penetration is not achieved, the joint will have two built-in stress risers which may greatly reduce the strength of the weld. Upon application of an extreme load, these stress risers could result in cracks which could propagate out through the weld or tube depending upon the direction of the greatest load.

Often to achieve full root penetration in TIG welding of stainless steels, a fusion pass will be made first, followed by a final pass utilizing a filler rod to achieve the desired fillet size.

Assembly

The codes applicable to the welding of socket weld fittings require that the tube be inserted into the socket until bottomed against the stop. The tube is then to be backed out approximately 1/16 of an inch and then welded.

If the tube is not backed out, but welded when against a flat bottom stop, the contraction of the weld fillet and fitting socket can combine to produce a static stress on the weld. During thermal transients, the fitting and the portion of the tube within the fitting may experience a differential rate of heating or cooling, again adding to the stress level in the weld.

Tacking

If the weld joint is to be “tacked” before welding, it is recommended that the “Tack” weld build-up be held to a minimum.

Excessive build-up on the “tack” may cause an interrupted final bead and a stress riser or lack of complete fusion.

Backing Gas

Backing gas is an inert gas used to flood the interior of the fittings and tube system during welding. It serves the same purpose internally as the shielding gas used in TIG or MIG welding. By reducing the interior oxygen level to as low as practicable, it also serves to control the combustion of contaminants that could affect weld quality.

When a backing gas is not used and nearly 100% weld penetration is achieved, blisters will tend to form on the internal tube wall. This will result in scale which may later break loose. Therefore, in 0.050 wall or thinner tube or where the wall thickness is such that the selected weld process may burn through, the use of a backing gas is mandatory.

In most cases the backing gas will be argon or helium connected to the system through a control regulator. Flow rates, while small, should be high enough to purge the system. Welds should be made in downstream sequence from the gas connection.

Note that the entire system should be purged to insure that there are no openings that will allow air to be drawn into the system.

The use of backing gas, while often not mandatory, will give a better weld joint. This is because the effects of contaminate combustion by-products are eliminated and because the welds are made and cooled under a shielded atmosphere, thus eliminating internal scaling or blistering.

Welding Methods

300 Series Stainless Steels

May be welded by the TIG, MIG, or stick arc-weld process.

TIG welding is recommended as being best for welding Weld-lok® systems because it allows better operator control of heat penetration and filler material deposition.

Stick arc welding is not recommended in many cases because of the likelihood of excessive burn-through and improper root penetration. In all cases where stick welding is used, it is recommended that backing gas be used.

MIG welding gives the same characteristics as stick electrode welding with faster deposition of the filler material. As this process runs “hotter” than the stick process, the use of a backing gas is mandatory. It should be noted that in welding the relatively small fitting sizes found in the Weld-lok® line, filler deposition rate economies are not a factor and therefore the MIG method is not commonly applied.

C1018 Steel Fittings

May be welded by the TIG, MIG, stick and oxyacetylene methods. As scale formation remains a problem, the use of a backing gas is still recommended.

Carbide Precipitation

When unstabilized stainless steels are heated to 800° – 1500°F during welding, the chromium in the steel combines with the carbon to form chrome carbides which tend to form along the grain boundaries of the metal (carbide precipitation). This lowers the dissolved chromium content in these areas and thus lowers their corrosion resistance, making them vulnerable to intergranular corrosion. Carbide precipitation is reduced by holding the carbon content of the material to a very low value. This limits the amount of carbon available to combine with the chromium. The “L” series (extra low carbon) stainless steels are often used for this purpose, but their use reduces system design stress by approximately 15%. Parker Weld-lok® fittings are made from a select 316 series with carbon content in the low range of 0.04 to 0.07 percent. This results in a welded fitting with good corrosion resistance and a high strength factor.

All Parker Weld-lok® fittings in stainless steel are supplied in the solution treated condition, capable of passing ASTM-A-262 Tests for Detecting Susceptibility to Intergranular Corrosion.

Arc Polarity

When welding Weld-lok® fittings, best results will be obtained by the following arc polarities:

- TIG – Direct Current, straight polarity
- MIG – Direct Current, reverse polarity
- STICK – Polarity dependent on rod used

Tube to Welded Systems

Socket Weld Elbow

For fractional tube

- for CPI™/A-LOK® to tubing socket weld connection

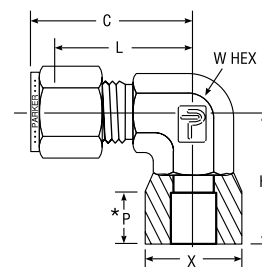
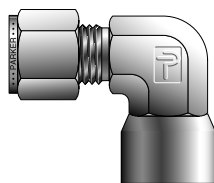

CPI™ PART NO.	A-LOK® PART NO.	INTER- CHANGES WITH	INCHES						
			TUBE O.D.	C	L	H	P*	X	W HEX
2-2 ZEBW	2-2 ZELW	200-9-2W	1/8	0.92	0.66	0.63	.16	.38	5/16
3-3 ZEBW	3-3 ZELW	300-9-3W	3/16	0.98	0.72	0.69	.20	.44	7/16
4-4 ZEBW	4-4 ZELW	400-9-4W	1/4	1.06	0.78	0.84	.25	.50	9/16
6-6 ZEBW	6-6 ZELW	600-9-6W	3/8	1.31	1.02	1.08	.34	.63	3/4
8-8 ZEBW	8-8 ZELW	810-9-8W	1/2	1.42	1.02	1.14	.41	.76	3/4
10-10 ZEBW	10-10 ZELW	1010-9-10W	5/8	1.57	1.17	1.35	.49	.94	1-1/16
12-12 ZEBW	12-12 ZELW	1210-9-12W	3/4	1.57	1.17	1.39	.50	1.09	1-1/16
16-16 ZEBW	16-16 ZELW	1610-9-16W	1	1.93	1.65	1.84	.56	1.38	1-5/8

NOTE: C dimension is typical finger-tight.

Dimensions for reference only, subject to change.

*Socket Depth

Buttweld Elbow

For fractional tube

- for CPI™/A-LOK® to pipe buttweld connection

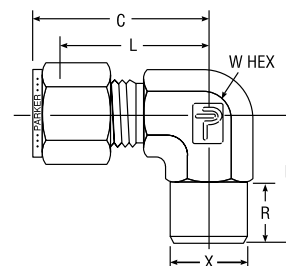
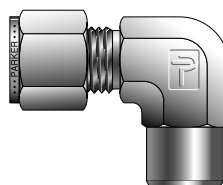

CPI™ PART NO.	A-LOK® PART NO.	INTER- CHANGES WITH	INCHES							
			TUBE O.D.	BUTTWELD PIPE SIZE	C	H	L	R	X BUTTWELD O.D.	W HEX
2-1/8 ZEBW2	2-1/8 ZELW2	200-2-2W	1/8	1/8	0.93	0.70	0.67	.38	.405	7/16
3-1/8 ZEBW2	3-1/8 ZELW2	300-2-2W	3/16	1/8	1.01	0.74	0.74	.38	.405	7/16
4-1/8 ZEBW2	4-1/8 ZELW2	400-2-2W	1/4	1/8	1.06	0.74	0.77	.38	.405	7/16
4-1/4 ZEBW2	4-1/4 ZELW2	400-2-4W	1/4	1/4	1.10	0.97	0.78	.56	.540	9/16
6-1/4 ZEBW2	6-1/4 ZELW2	600-2-4W	3/8	1/4	1.20	1.00	0.91	.56	.540	5/8
8-3/8 ZEBW2	8-3/8 ZELW2	810-2-6W	1/2	3/8	1.42	1.11	1.02	.56	.675	13/16
8-1/2 ZEBW2	8-1/2 ZELW2	810-2-8W	1/2	1/2	1.42	1.30	1.02	.75	.840	7/8
10-1/2 ZEBW2	10-1/2 ZELW2	1010-2-8W	5/8	1/2	1.50	1.39	1.10	.75	.840	15/16
12-3/4 ZEBW2	12-3/4 ZELW2	1210-2-12W	3/4	3/4	1.57	1.45	1.17	.75	1.050	1-1/16
16-3/4 ZEBW2	16-3/4 ZELW2	1610-2-12W	1	3/4	1.94	1.64	1.45	.75	1.050	1-3/8
16-1 ZEBW2	16-1 ZELW2	1610-2-16W	1	1	1.94	1.84	1.45	.94	1.315	1-5/16

NOTE: C dimension is typical finger-tight.

Dimensions for reference only, subject to change.

Pipe buttweld end will conform to Schedule 80 unless otherwise noted.

Color Coding

For easy reference, table column headings are color indicated as follows:

fractional

metric



Single/Double Ferrule
Instrument Compression
Fittings

Tube to Welded Systems

Single/Double Ferrule
Instrument Compression
Fittings

Socket Weld Connector

For fractional tube

- for CPI™ /A-LOK® to tubing socket weld connection

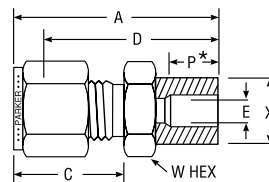
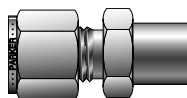

CPI™ PART NO.	A-LOK® PART NO.	INTER- CHANGES WITH	INCHES							
			TUBE O.D.	A	C	D	P*	X	E BORE	W HEX
2-2 ZHBW	2-2 ZHLW	200-6-2W	1/8	1.16	0.60	0.90	.16	0.38	.094	7/16
3-3 ZHBW	3-3 ZHLW	300-6-3W	3/16	1.24	0.64	0.98	.20	0.44	.141	1/2
4-4 ZHBW	4-4 ZHLW	400-6-4W	1/4	1.36	0.70	1.07	.25	0.50	.188	9/16
6-6 ZHBW	6-6 ZHLW	600-6-6W	3/8	1.53	0.76	1.24	.34	0.63	.313	11/16
8-8 ZHBW	8-8 ZHLW	810-6-8W	1/2	1.74	0.87	1.34	.41	0.78	.438	13/16
10-10 ZHBW	10-10 ZHLW	1010-6-10W	5/8	1.86	0.87	1.46	.47	0.94	.500	1
12-12 ZHBW	12-12 ZHLW	1210-6-12W	3/4	1.92	0.87	1.52	.50	1.09	.656	1-1/8
16-16 ZHBW	16-16 ZHLW	1610-6-16W	1	2.31	1.05	1.82	.56	1.44	.906	1-5/8

NOTE: A and C dimensions are typical finger-tight.

Dimensions for reference only, subject to change.

See Catalog 4280, Welded Fittings, for additional sizes.

*Socket Depth

Buttweld Connector

For fractional tube

- for CPI™ /A-LOK® to pipe buttweld connection

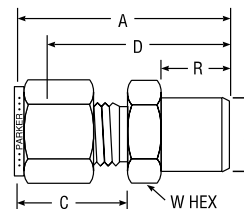
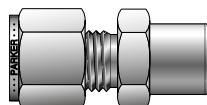

CPI™ PART NO.	A-LOK® PART NO.	INTER- CHANGES WITH	INCHES							
			TUBE O.D.	BUTTWELD PIPE SIZE	A	C	D	R	X BUTTWELD O.D.	W HEX
2-1/8 ZHBW2	2-1/8 ZHLW2	200-1-2W	1/8	1/8	1.20	0.60	0.94	.38	.405	7/16
3-1/8 ZHBW2	3-1/8 ZHLW2	300-1-2W	3/16	1/8	1.24	0.64	0.97	.38	.405	7/16
4-1/8 ZHBW2	4-1/8 ZHLW2	400-1-2W	1/4	1/8	1.29	0.70	1.00	.38	.405	1/2
4-1/4 ZHBW2	4-1/4 ZHLW2	400-1-4W	1/4	1/4	1.46	0.70	1.17	.56	.540	9/16
5-1/8 ZHBW2	5-1/8 ZHLW2	500-1-2W	5/16	1/8	1.48	0.73	1.22	.38	.405	1/2
5-1/4 ZHBW2	5-1/4 ZHLW2	500-1-4W	5/16	1/4	1.49	0.76	1.23	.56	.540	9/16
6-1/4 ZHBW2	6-1/4 ZHLW2	600-1-4W	3/8	1/4	1.49	0.76	1.20	.56	.540	9/16
6-3/8 ZHBW2	6-3/8 ZHLW2	600-1-6W	3/8	3/8	1.60	0.76	1.31	.56	.675	3/4
6-1/2 ZHBW2	6-1/2 ZHLW2	600-1-8W	3/8	1/2	1.82	0.76	1.53	.75	.840	7/8
6-3/4 ZHBW2	6-3/4 ZHLW2	600-1-12W	3/8	3/4	1.88	0.76	1.59	.75	1.050	1-1/8
8-3/8 ZHBW2	8-3/8 ZHLW2	810-1-6W	1/2	3/8	1.71	0.87	1.31	.56	.675	13/16
8-1/2 ZHBW2	8-1/2 ZHLW2	810-1-8W	1/2	1/2	1.93	0.87	1.53	.75	.840	7/8
8-3/4 ZHBW2	8-3/4 ZHLW2	810-1-12W	1/2	3/4	1.99	0.87	1.59	.75	1.050	1-1/8
10-1/2 ZHBW2	10-1/2 ZHLW2	1010-1-8W	5/8	1/2	1.93	0.87	1.53	.75	.840	15/16
12-3/4 ZHBW2	12-3/4 ZHLW2	1210-1-12W	3/4	3/4	1.99	0.87	1.59	.75	1.050	7/8
16-1 ZHBW2	16-1 ZHLW2	1610-1-16W	1	1	2.46	1.05	1.97	.94	1.310	1-1/16

NOTE: A and C dimensions are typical finger-tight.

Dimensions for reference only, subject to change.

Pipe Buttweld end will conform to Schedule 80 unless otherwise noted.
See Catalog 4280, Welded Fittings, for additional sizes.

Tube to Welded Systems

Buttweld Connector

For metric tube

- for CPI™/A-LOK® to pipe buttweld connection

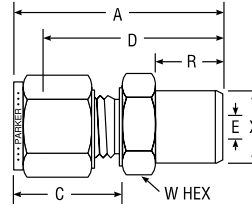
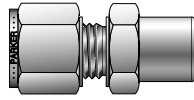

CPI™ PART NO.	A-LOK® PART NO.	INTER- CHANGES WITH	MILLIMETERS								
			TUBE O.D.	BUTTWELD PIPE N.B.	A	C	D	R	X	E BORE	W HEX
ZHBW2 3-1/8	ZHLW2 3-1/8	3MO-1-2W	3	1/8	29,7	15,3	23,1	9,7	10,3	2,4*	12,0
ZHBW2 4-1/8	ZHLW2 4-1/8	4MO-1-2W	4	1/8	30,7	16,1	24,1	9,7	10,3	2,4*	12,0
ZHBW2 6-1/8	ZHLW2 6-1/8	6MO-1-2W	6	1/8	32,9	17,7	25,4	9,7	10,3	4,8	14,0
ZHBW2 6-1/4	ZHLW2 6-1/4	6MO-1-4W	6	1/4	37,7	17,7	30,2	14,2	13,7	4,8*	14,0
ZHBW2 8-1/8	ZHLW2 8-1/8	8MO-1-2W	8	1/8	34,2	18,6	26,7	9,7	10,3	5,1	15,0
ZHBW2 8-1/4	ZHLW2 8-1/4	8MO-1-4W	8	1/4	38,7	18,6	31,2	14,2	13,7	6,4	15,0
ZHBW2 8-1/2	ZHLW2 8-1/2	8MO-1-8W	8	1/2	44,8	18,6	37,3	19,1	21,3	6,4*	22,0
ZHBW2 10-1/4	ZHLW2 10-1/4	10MO-1-4W	10	1/4	40,9	19,5	33,3	14,2	13,7	7,1	18,0
ZHBW2 10-3/8	ZHLW2 10-3/8	10MO-1-6W	10	3/8	40,1	19,5	32,5	14,2	17,2	7,9*	18,0
ZHBW2 10-1/2	ZHLW2 10-1/2	10MO-1-8W	10	1/2	45,7	19,5	38,1	19,1	21,3	7,9*	22,0
ZHBW2 12-1/4	ZHLW2 12-1/4	12MO-1-4W	12	1/4	43,4	22,0	33,3	14,2	13,7	7,1	22,0
ZHBW2 12-3/8	ZHLW2 12-3/8	12MO-1-6W	12	3/8	43,4	22,0	33,3	14,2	17,2	9,5	22,0
ZHBW2 12-1/2	ZHLW2 12-1/2	12MO-1-8W	12	1/2	48,2	22,0	38,1	19,1	21,3	9,5*	22,0
ZHBW2 15-1/2	ZHLW2 15-1/2	15MO-1-8W	15	1/2	48,2	22,0	38,9	19,1	21,3	9,5*	24,0
ZHBW2 16-1/2	ZHLW2 16-1/2	16MO-1-8W	16	1/2	49,0	22,0	38,9	19,1	21,3	12,7*	24,0
ZHBW2 18-1/2	ZHLW2 18-1/2	18MO-1-8W	18	1/2	50,5	22,0	40,4	19,1	21,3	13,5	27,0

NOTE: *E dimension is minimum opening.
 Fittings of this group may be back-drilled to larger I.D. at pipe end.
 A and C dimensions are typical finger-tight.
 Pipe Buttweld end will conform to Schedule 80 unless otherwise noted.

Dimensions for reference only, subject to change.

Single/Double Ferrule
Instrument Compression
Fittings

Color Coding

For easy reference, table column headings are color indicated as follows:

fractional



metric



Analytical Fittings

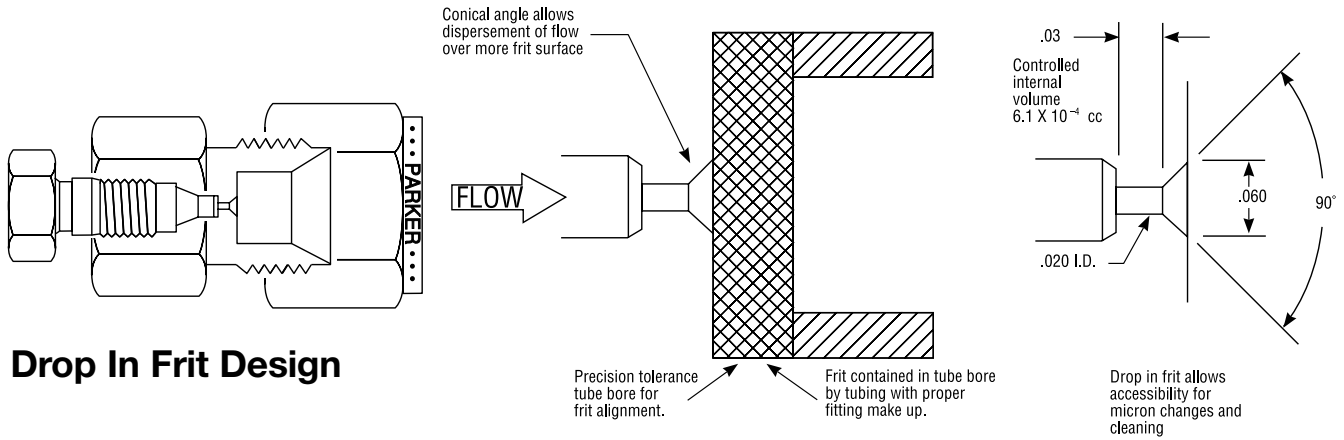

Drop In Frit Design

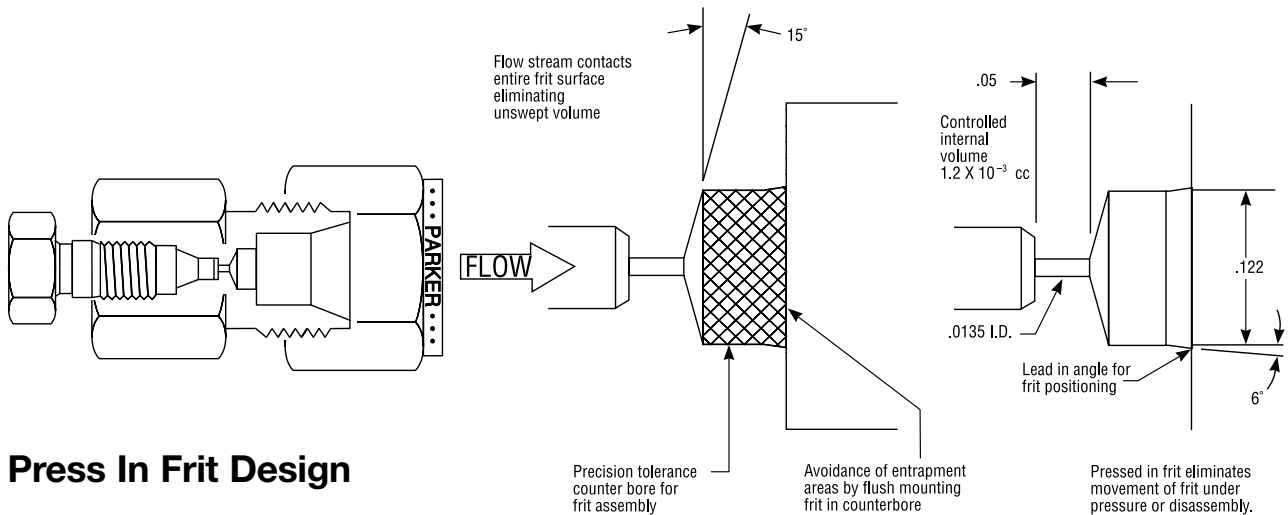

Press In Frit Design

Parker Hannifin's Instrumentation Products Division offers a full line of analytical tube fittings. These fittings range from elbows, tees, and male connectors to low dead volume unions and column end fittings. Parker incorporates various features in the column end fittings to effectively address various industry concerns.

- Peak symmetry for critical analysis
- Internal volume reduction

As the observed media/substance migrates through the HPLC column, a "peak" or "band" is created that denotes the level of concentration. It is critical to maintain peak symmetry in order to get an accurate reading when processing the observed media/substance. Parker Hannifin, in the development of a line of column end fittings, has incorporated some key features that help to maintain this "peak symmetry" in HPLC columns.

"Under most circumstances in liquid chromatography (LC), the flow through the tube is laminar, the so-called Poiseuille flow, and in this situation the velocity at all points is parallel to the tube axis."

Due to the importance of maintaining smooth laminar flow after injection of the sample into the HPLC column, Parker

incorporated a small conical angle on the fitting body internals. This conical angle helps to equally disperse the sample into the column tube. One of the key requirements of an effective column end fitting is not to delay or disturb the flow of the sample through the instrument (HPLC column).

A second area to address is the minimizing of tube fitting internal "cavities". A cavity is a short section of the flow path where the flow-channel diameter increases. It can occur where tubes are connected to each other (low dead volume connector) or to injectors, columns (column end fittings), and detectors. Large cavities can seriously degrade the resolution of any chromatogram, but they can be easily avoided through awareness of the geometric design details of the fittings and connecting parts manufactured by various companies.

Parker Hannifin has incorporated those critical features in both a low dead volume union connector and the column end fitting bodies. First, the utilization of inverted 1/16" connections to greatly reduce internal volume or cavities. To eliminate any confusion or occurrence of incorrect effective tube make-up, the port depths (body bore dimensions) are identical by size throughout the entire Parker Hannifin instrumentation line. Second, Parker closely monitors the dimensions of the small through-hole utilized in these low dead volume connectors.

Analytical Fittings

Column End Fitting – Low Internal Volume with Frit

For fractional tube

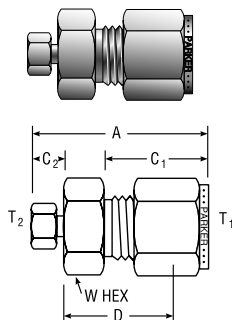

CPI™ PART NO.	A-LOK® PART NO.	INCHES							INTERNAL VOLUME
		T ₁ TUBE O.D.	T ₂ TUBE O.D.	A	C	D	W HEX	INTERNAL OPENING	
2-1 Z2HCZ7	2-1 Z2HLZ7	1/8	1/16	1.25	.60	.78	7/16	.013	5.4 x 10-4cc
4-1 Z2HCZ7	4-1 Z2HLZ7	1/4	1/16	1.35	.70	.84	1/2	.013	1.2 x 10-3cc
6-1 Z2HCZ7	6-1 Z2HLZ7	3/8	1/16	1.43	.76	.92	5/8	.013	3.8 x 10-3cc

NOTE: A and C dimensions are typical finger-tight.

Dimensions for reference only, subject to change.

FRIT DESIGNATOR	
* MICRON DASH NO.	MICRON SIZE
-1	0.5 μ
-2	2 μ
-3	5 μ
-4	10

HOW TO ORDER
EXAMPLE: 4-1Z2HLZ7-2*-SS To order with 2μ frit for 1/4" O.D. column

Features:

- Inverted 1/16" end substantially reduces internal volume
- Flow stream contacts entire frit surface reducing plugging and eliminating unswept volume
- Can be used as a low volume final filter

Column End Fitting – Low Internal Volume

For fractional tube

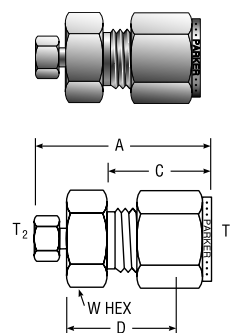

CPI™ PART NO.	A-LOK® PART NO.	INCHES							INTERNAL VOLUME
		T ₁ TUBE O.D.	T ₂ TUBE O.D.	A	C	D	W HEX	INTERNAL OPENING	
4-1 Z3HCZ7	4-1 Z3HLZ7	1/4	1/16	1.28	0.70	0.77	1/2	.020	6.1 x 10-4cc
6-1 Z3HCZ7	6-1 Z3HLZ7	3/8	1/16	1.37	0.76	0.86	5/8	.020	8.1 x 10-4cc
8-1 Z3HCZ7	8-1 Z3HLZ7	1/2	1/16	1.62	0.87	1.00	13/16	.030	2.8 x 10-3cc
16-1 Z3HCZ7	16-1 Z3HLZ7	1	1/16	2.00	1.05	1.31	1-3/8	.030	2 x 10-2cc

NOTE: A and C dimensions are typical finger-tight.

Dimensions for reference only, subject to change.

Features:

- Inverted 1/16" end substantially reduces internal volume
- Drop in frit for use with L.C.* columns or G.C.* columns
- Conical angle below frit directs flow over more frit surface
- Available for up to 1" columns

*G.C. = Gas Chromatograph
L.C. = Liquid Chromatograph

Di-Frit (drop in)

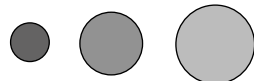

Replaceable frit for preparatory column end fitting Z3HLZ7. Frits are available in 2, 5 and 10 micron sizes.

CPI™/ A-LOK® PARKER PART NO.	MICRON SIZE	COLUMN O.D.
4 DI FRIT-5MIC-SS	5	1/4"
4 DI FRIT-10MIC-SS	10	1/4"
6 DI FRIT-2MIC-SS	2	3/8"
6 DI FRIT-5MIC-SS	5	3/8"
6 DI FRIT-10MIC-SS	10	3/8"

PARKER PART NO.	MICRON SIZE	COLUMN O.D.
8 DI FRIT-5MIC-SS	5	1/2"
8 DI FRIT-10MIC-SS	10	1/2"
16 DI FRIT-2MIC-SS	2	1"
16 DI FRIT-5MIC-SS	5	1"
16 DI FRIT-10MIC-SS	10	1"

Color Coding

For easy reference, table column headings are color indicated as follows:

fractional

metric

Analytical Fittings

Column End Fitting – Low Internal Volume (without Frit) For fractional tube

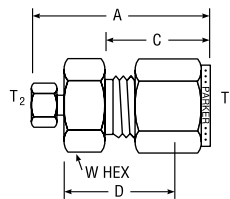
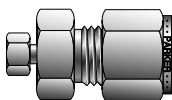

CPI™ PART NO.	A-LOK® PART NO.	INTER- CHANGES WITH	INCHES							INTERNAL OPENING	INTERNAL VOLUME
			T ₁ TUBE O.D.	T ₂ TUBE O.D.	A	C	D	W HEX			
2-1 ZHCZ7	2-1 ZHLZ7	-200-6-1-FGC	1/8	1/16	1.16	.60	.70	7/16	.013	1.0 x 10 ⁻⁴ cc	
4-1 ZHCZ7	4-1 ZHLZ7	-400-6-1-FGC	1/4	1/16	1.24	.70	.77	1/2	.013	1.1 x 10 ⁻⁴ cc	
6-1 ZHCZ7	6-1 ZHLZ7	-600-6-1-FGC	3/8	1/16	1.35	.76	.86	5/8	.013	1.3 x 10 ⁻⁴ cc	

NOTE: A and C dimensions are typical finger-tight.

Dimensions for reference only, subject to change.

Features:

- Inverted 1/16" end substantially
- No frit for use with G.C.* columns or L.C.* columns with screens
- Can be used as a low volume reducing union

*G.C. = Gas Chromatograph
L.C. = Liquid Chromatograph

Column End Fitting – with Frit For fractional tube

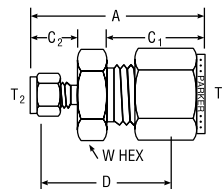
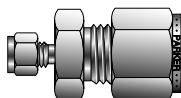

CPI™ PART NO.	A-LOK® PART NO.	INCHES							INTERNAL OPENING	INTERNAL VOLUME
		T ₁ TUBE O.D.	T ₂ TUBE O.D.	A	C1	C2	D	W HEX		
2-1 Z2HCZ	2-1 Z2HLZ	1/8	1/16	1.21	.60	.43	.81	7/16	.020	2.1 x 10 ⁻³ cc
4-1 Z2HCZ	4-1 Z2HLZ	1/4	1/16	1.35	.70	.43	.91	1/2	.020	1.8 x 10 ⁻³ cc
6-1 Z2HCZ	6-1 Z2HLZ	3/8	1/16	1.44	.76	.43	1.00	5/8	.020	5.4 x 10 ⁻³ cc

NOTE: A and C dimensions are typical finger-tight.

Dimensions for reference only, subject to change.

FRIT DESIGNATOR	
* MICRON DASH NO.	MICRON SIZE
-1	0.5μ
-2	2.0μ
-3	5.0μ
-4	10.0μ

NOTE: Size 1 not silver-plated.

HOW TO ORDER
EXAMPLE: 4-1Z2HLZ-2*-SS To order with 2μ frit for 1/4" O.D. column

Features:

- Flow stream contacts entire frit surface reducing plugging and eliminating unswept volume
- Can be used as a low volume final filter with drop-in frit

Analytical Fittings

Column End Fitting – (without Frit) For fractional tube

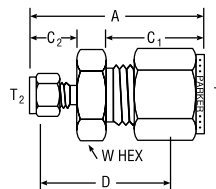
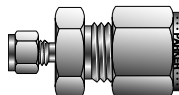

CPI™ PART NO.	A-LOK® PART NO.	INTER- CHANGES WITH	INCHES								INTERNAL OPENING	INTERNAL VOLUME
			T ₁ TUBE O.D.	T ₂ TUBE O.D.	A	C ₁	C ₂	D	W HEX			
2-1 ZHCZ	2-1 ZHLZ	200-6-1LV	1/8	1/16	1.21	.60	.43	0.81	7/16	.020	2.1 x 10-3cc	
4-1 ZHCZ	4-1 ZHLZ	400-6-1LV	1/4	1/16	1.35	.70	.43	0.91	1/2	.020	2.1 x 10-3cc	
6-1 ZHCZ	6-1 ZHLZ	600-6-1LV	3/8	1/16	1.44	.76	.43	1.00	5/8	.020	2.3 x 10-3cc	

NOTE: A and C dimensions are typical finger-tight.

Dimensions for reference only, subject to change.

Size 1 Nut is not silver plated

Union Connector – Low Dead Volume For fractional tube

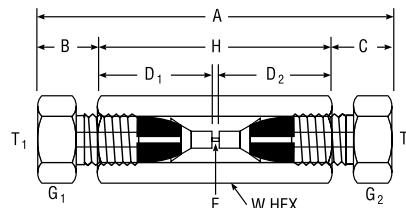

CPI™ PART NO.	A-LOK® PART NO.	INTER- CHANGES WITH	INCHES												INTERNAL VOLUME
			T ₁ TUBE O.D.	T ₂ TUBE O.D.	†A	†B	†C	D ₁	D ₂	E INTERNAL OPENING	G ₁	G ₂	H	W HEX	
1-1 Z7HBZ7-SS	1-1 Z7HLZ7	IFO-6GC	1/16	1/16	1.26	.21	.21	.41	.41	.013	.25	.25	.84	1/4	8.7 x 10-5cc
2-1 Z7HBZ7-SS	2-1 Z7HLZ7	-	1/8	1/16	1.53	.31	.21	.56	.41	.013	.38	.25	1.02	7/16	8.7 x 10-5cc
2-2 Z7HBZ7-SS	2-2 Z7HLZ7	-	1/8	1/8	1.81	.31	.31	.56	.56	.052	.38	.38	1.19	7/16	9.7 x 10-2cc

†Average Value

Dimensions for reference only, subject to change.

Color Coding

For easy reference, table column headings are color indicated as follows:

fractional

metric

Analytical Fittings

Male Connector – Low Dead Volume For fractional tube

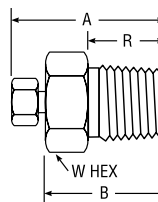
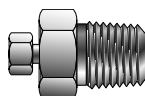

CPI™ PART NO.	A-LOK® PART NO.	INCHES							INTERNAL OPENING	INTERNAL VOLUME
		NPT TUBE O.D.	PIPE THREAD	†A	B	R	W HEX			
1-1 FBZ7	1-1 FLZ7	1/16	1/16	.75	.55	.38	5/16	.013	3.1 x 10-4cc	
1-2 FBZ7	1-2 FLZ7	1/16	1/8	.79	.59	.38	7/16	.013	4.4 x 10-4cc	
1-4 FBZ7	1-4 FLZ7	1/16	1/4	1.01	.81	.56	5/8	.013	8.8 x 10-4cc	

†Average Value

Dimensions for reference only, subject to change.

Sanitary Flange Fitting For fractional tube

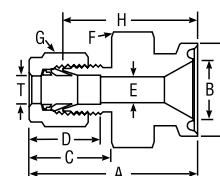
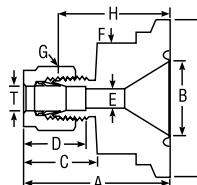

CPI™ PART NO.	A-LOK® PART NO.	INTER- CHANGES WITH	INCHES										
			TUBE O.D.	SANITARY FLANGE	A	B	C	D	E MIN. OPENING	F	G HEX FLAT	H	I
4-8 ZHBS	4-8 ZHLS-SS	SS-400-SC-8	1/4	1/2	1.57	.37	.70	.60	.19	1.00	9/16	1.34	.98
4-12 ZHBS	4-12 ZHLS-SS	SS-400-SC-12	1/4	3/4	1.57	.62	.70	.60	.19	1.00	9/16	1.34	.98
4-16 ZHBS	4-16 ZHLS-SS	SS-400-SC-16	1/4	1	1.57	.87	.70	.60	.19	1.38	9/16	1.34	1.98
4-24 ZHBS	4-24 ZHLS-SS	SS-400-SC-24	1/4	1 1/2	1.57	1.37	.70	.60	.19	1.38	9/16	1.28	1.98
6-8 ZHBS	6-8 ZHLS-SS	SS-600-SC-8	3/8	1/2	1.63	.37	.76	.66	.28	1.00	11/16	1.34	.98
6-12 ZHBS	6-12 ZHLS-SS	SS-600-SC-12	3/8	3/4	1.63	.62	.76	.66	.28	1.00	11/16	1.34	.98
6-16 ZHBS	6-16 ZHLS-SS	SS-600-SC-16	3/8	1	1.63	.87	.76	.66	.28	1.38	11/16	1.34	1.98
6-24 ZHBS	6-24 ZHLS-SS	SS-600-SC-24	3/8	1 1/2	1.63	1.37	.76	.66	.28	1.38	11/16	1.34	1.98
8-8 ZHBS	8-8 ZHLS-SS	SS-810-SC-8	1/2	1/2	1.74	.37	.90	.86	.37	1.00	7/8	1.40	.98
8-12 ZHBS	8-12 ZHLS-SS	SS-810-SC12	1/2	3/4	1.74	.62	.90	.86	.41	1.00	7/8	1.34	.98
8-16 ZHBS	8-16 ZHLS-SS	SS-810-SC-16	1/2	1	1.74	.87	.90	.86	.41	1.38	7/8	1.34	1.98
8-24 ZHBS	8-24 ZHLS-SS	SS-810-SC-24	1/2	1 1/2	1.74	1.37	.90	.86	.41	1.38	7/8	1.34	1.98

NOTE: A, C, and D dimensions are typical finger tight.

Dimensions for reference only, subject to change.

Sanitary flange fittings combine the reliability and versatility of Parker tube fittings with conventional sanitary flanges.

The fittings permit direct downstream connections for hookups and sampling.

Flange sizes are 1/2, 3/4, 1, and 1-1/2 in.

Parker tube fitting ends are available in 1/4, 3/8, and 1/2 in. Parker tube fittings allow use of a variety of tubing materials including metal, hard plastic, and soft plastic.

For a Thermocouple/"Bored-Thru" version of the above Sanitary Adapter fittings, add a "4" to the part number. Example: A 4-12 ZHLS-SS becomes a 4-12 ZH4LS-SS for a 3/4" Sanitary Flange with a 1/4" diameter bored through on the A-LOK® fitting end.

For the full line of Sanitary Fittings and Flow Components, see Catalog 4270-Sanitary/ASME-BPE Fittings.

Barbed Fittings

Barbed Connector to Male Pipe

For fractional tube

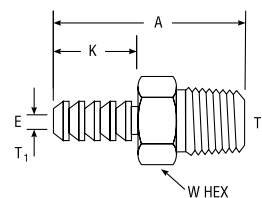
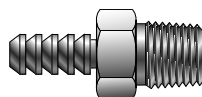

CPI™ PART NO.	A-LOK® PART NO.	INTER- CHANGES WITH	INCHES					
			T HOSE I.D.	T ₂ MALE PIPE SIZE	A	E BORE	K	W HEX
2-2 B2HF	2-2 B2HF	2-HC-1-2	1/8	1/8	1.00	.078	0.41	7/16
2-4 B2HF	2-4 B2HF	2-HC-1-4	1/8	1/4	1.22	.078	0.41	9/16
4-2 B2HF	4-2 B2HF	4-HC-1-2	1/4	1/8	1.41	.188	0.75	7/16
4-4 B2HF	4-4 B2HF	4-HC-1-4	1/4	1/4	1.59	.188	0.78	9/16
5-2 B2HF	5-2 B2HF	5-HC-1-2	5/16	1/8	1.50	.188	0.88	7/16
5-4 B2HF	5-4 B2HF	5-HC-1-4	5/16	1/4	1.69	.250	0.88	9/16
6-4 B2HF	6-4 B2HF	6-HC-1-4	3/8	1/4	1.72	.281	0.88	9/16
6-6 B2HF	6-6 B2HF	6-HC-1-6	3/8	3/8	1.72	.297	0.88	11/16
8-6 B2HF	8-6 B2HF	8-HC-1-6	1/2	3/8	1.81	.375	0.94	3/4
8-8 B2HF	8-8 B2HF	8-HC-1-8	1/2	1/2	2.00	.375	0.94	7/8
12-12 B2HF	12-12 B2HF	12-HC-1-12	3/4	3/4	2.13	.625	1.03	1-1/16

Dimensions for reference only, subject to change.

Barbed Connector to Tube Adapter

For fractional tube

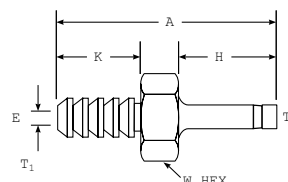
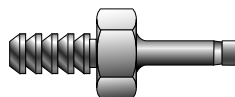

CPI™ PART NO.	A-LOK® PART NO.	INTER- CHANGES WITH	INCHES						
			T ₁ TUBE I.D.	T ₂ TUBE O.D.	A	E BORE	H	K	W HEX
2-2 B2HT2	2B2TU2	2-HC-A-201	1/8	1/8	1.16	.078	.53	.41	5/16
2-4 B2HT2	2B2TU4	2-HC-A-401	1/8	1/4	1.26	.078	.64	.41	3/8
4-4 B2HT2	4B2TU4	4-HC-A-401	1/4	1/4	1.64	.156	.64	.78	3/8
6-6 B2HT2	6B2TU6	6-HC-A-601	3/8	3/8	1.75	.156	.72	.78	7/16

Dimensions for reference only, subject to change.

NOTE: Tube adapter end is designed for use with Parker fittings or valves. Simply insert the tube adapter end until it bottoms and tighten the Parker nut 3/4 turns for sizes 3 and below, for sizes 4 and above 1-1/4 turns from finger tight.

Add -Z6 for assembly of nuts and ferrules on the tube stub end.

Hose Connector Sleeve

For fractional tube

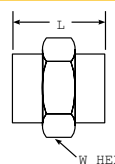

PARKER PART NO.	INCHES			
	HOSE I.D.	HOSE O.D.	L	W HEX
HCS 2-4	1/8	1/4	0.41	3/8
HCS 4-6	1/4	3/8	0.78	9/16
HCS 4-7	1/4	7/16	0.78	5/8
HCS 4-8	1/4	1/2	0.78	11/16
HCS 4-9	1/4	9/16	0.78	3/4
HCS 5-7	5/16	7/16	0.88	5/8
HCS 6-8	3/8	1/2	0.88	11/16
HCS 6-9	3/8	9/16	0.88	3/4
HCS 8-11	1/2	11/16	0.94	7/8
HCS 12-16	3/4	1	1.06	1-1/4

Dimensions for reference only, subject to change.

Color Coding

For easy reference, table column headings are color indicated as follows:

fractional

metric

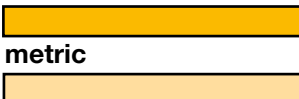

Components

Insert

For fractional tube

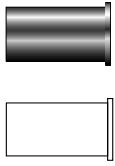

PARKER PART NO.	INTER-CHANGES WITH	INCHES		
		TUBE O.D.	TUBE I.D.	TUBE WALL
3 TIZ .125	305-2	3/16	.125	.031
4 TIZ .125	405-2	1/4	.125	.062
4 TIZ .170	405-170	1/4	.170	.040
4 TIZ .188	405-3	1/4	.188	.031
5 TIZ .125	505-2	5/16	.125	.094
5 TIZ .188	505-3	5/16	.188	.062
5 TIZ .250	505-4	5/16	.250	.031
6 TIZ .188	605-3	3/8	.188	.094
6 TIZ .250	605-4	3/8	.250	.062
8 TIZ .250	815-4	1/2	.250	.125
8 TIZ .375	815-6	1/2	.375	.062
10 TIZ .375	1015-6	5/8	.375	.125
10 TIZ .500	1015-8	5/8	.500	.062
12 TIZ .500	1215-8	3/4	.500	.125
12 TIZ .625	1215-10	3/4	.625	.062
16 TIZ .750	1615-12	1	.750	.125
16 TIZ .875	1615-14	1	.875	.062

Dimensions for reference only, subject to change.

NOTE: Tubing wall thickness and corresponding minimum I.D. flow paths are listed so the system designer can properly match the insert to the tubing.

Example: 4 TIZ .125 is used with tubing having a wall thickness of .062 and I.D. of .125.

Insert

For metric tube

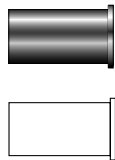

PARKER PART NO.	INTER-CHANGES WITH	MILLIMETERS		
		TUBE O.D.	TUBE I.D.	TUBE WALL
TIZ 6 (4)	6M5-4M	6	4	1,0
TIZ 8 (6)	8M5-6M	8	6	1,0
TIZ 10 (6)	10M5-6M	10	6	2,0
TIZ 10 (8)	10M5-8M	10	8	1,0
TIZ 12 (8)	12M5-8M	12	8	2,0
TIZ 12 (10)	12M5-10M	12	10	1,0
TIZ 15 (10)	15M5-10M	15	10	2,5

Dimensions for reference only, subject to change.

NOTE: Tubing wall thickness and corresponding minimum I.D. flow paths are listed so the system designer can properly match the insert to the tubing.

Example: TIZ 6 (4) is used with tubing having a wall thickness of 1mm and I.D. of 4mm.

TIZ inserts allow CPI™ / A-LOK® fittings to be used with soft plastic tubing.

Tube Nut

For fractional tube

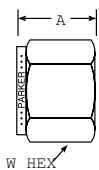

CPI™ PART NO.	A-LOK® PART NO.	INTER-CHANGES WITH	INCHES		
			TUBE O.D.	A	W HEX
1 BZ	1NU1	102-1	1/16	0.31	5/16
2 BZ	2NU2	202-1	1/8	0.47	7/16
3 BZ	3NU3	302-1	3/16	0.47	1/2
4 BZ	4NU4	402-1	1/4	0.50	9/16
5 BZ	5NU5	502-1	5/16	0.53	5/8
6 BZ	6NU6	602-1	3/8	0.56	11/16
8 BZ	8NU8	812-1	1/2	0.69	7/8
10 BZ	10NU10	1012-1	5/8	0.69	1
12 BZ	12NU12	1212-1	3/4	0.69	1-1/8
14 BZ	14NU14	1412-1	7/8	0.69	1-1/4
16 BZ	16NU16	1612-1	1	0.81	1-1/2
20 BZ	20NU20	2012-1	1-1/4	1.25	1-7/8
24 BZ	24NU24	2412-1	1-1/2	1.50	2-1/4
32 BZ	32NU32	3212-1	2	2.06	3

Dimensions for reference only, subject to change.

NOTE: All size 20, 24 and 32 silver plated nuts should have a system compatible lube (Permatex Anti-seize - Parker Catalog 4290-INST) or equivalent applied to the fitting body threads and the inside back of nuts. This will minimize the effort required to assemble the fitting properly.

Components

Tube Nut For metric tube

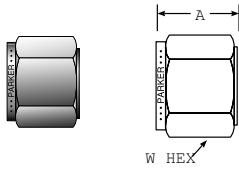

CPI™ PART NO.	A-LOK® PART NO.	INTER- CHANGES WITH	UN THREAD	MILLIMETERS		
				TUBE O.D.	A	W HEX
BZ 2	NUM2	2M2-1	5/16-20	2	11,9	12,0
BZ 3	NUM3	3M2-1	5/16-20	3	11,9	12,0
BZ 4	NUM4	4M2-1	3/8-20	4	11,9	12,0
BZ 6	NUM6	6M2-1	7/16-20	6	12,7	14,0
BZ 8	NUM8	8M2-1	1/2-20	8	13,5	16,0
BZ 10	NUM10	10M2-1	5/8-20	10	15,1	19,0
BZ 12	NUM12	12M2-1	3/4-20	12	17,5	22,0
BZ 14	NUM14	14M2-1	7/8-20	14	17,5	25,0
BZ 15	NUM15	15M2-1	7/8-20	15	17,5	25,0
BZ 16	NUM16	16M2-1	7/8-20	16	17,5	25,0
BZ 18	NUM18	18M2-1	1-20	18	17,5	30,0
BZ 20	NUM20	20M2-1	1.1/8-20	20	17,5	32,0
BZ 22	NUM22	22M2-1	1.1/8-20	22	17,5	32,0
BZ 25	NUM25	25M2-1	1.5/16-20	25	20,6	38,0

Dimensions for reference only, subject to change.

Inverted Tube Nut For fractional tube

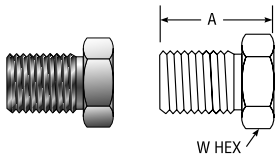

PARKER PART NO.	INTER- CHANGES WITH	INCHES		
		TUBE O.D.	A	W HEX
1 BZI	1F2-1GC	1/16	.39	1/4
2 BZI	2F2-1GC	1/8	.44	7/16

Dimensions for reference only, subject to change.

Knurled Nut For fractional tube

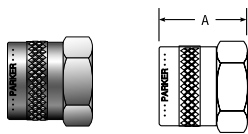

PARKER PART NO.	INTER- CHANGES WITH	INCHES	
		TUBE O.D.	A
1 BZP	102-1K	1/16	.32
2 BZP	202-1K	1/8	.47
3 BZP	302-1K	3/16	.47
4 BZP	402-1K	1/4	.51
5 BZP	502-1K	5/16	.54
6 BZP	812-1K	3/8	.57
8 BZP	602-1K	1/2	.69
10 BZP	1012-1K	5/8	.69

Dimensions for reference only, subject to change.

HOW TO ASSEMBLE BZP

1. Replaces BZ/NU nuts on Parker CPI™/A-LOK® fitting bodies.
2. Insert plastic tubing until it bottoms in fitting body.
3. Tighten finger tight.

The knurled nut is designed for use with soft plastic tubing on low pressure applications where a finger tight assembly procedure is satisfactory.

Example: Laboratory test hook-ups. Nylon or PTFE ferrules are frequently used instead of metal ferrules in this type of application.

Ferrules



PARKER PART NO.	INCHES TUBE O.D.
1 TZ	1/16
2 TZ	1/8
3 TZ	3/16
4 TZ	1/4
5 TZ	5/16
6 TZ	3/8
8 TZ	1/2
10 TZ	5/8
12 TZ	3/4
14 TZ	7/8
16 TZ	1
20 TZ	1-1/4
24 TZ	1-1/2
32 TZ	2

Dimensions for reference only, subject to change.

PARKER PART NO.	MILLIMETER TUBE O.D.
TZ 3	3
TZ 6	6
TZ 8	8
TZ 10	10
TZ 12	12
TZ 16	16
TZ 20	20
TZ 25	25

Dimensions for reference only, subject to change.

Note: Ferrules are available in standard metal materials as well as standard plastics like PTFE and nylon. Please consult the factory for availability.

Components

Single/Double Ferrule
Instrument Compression
Fittings

INCH Front Ferrule *For fractional tube*



PARKER PART NO.	INTER-CHANGES WITH	INCHES TUBE O.D.
1FF1	103-1	1/16
2FF2	203-1	1/8
3FF3	303-1	3/16
4FF4	403-1	1/4
5FF5	503-1	5/16
6FF6	603-1	3/8
8FF8	813-1	1/2
10FF10	1013-1	5/8
12FF12	1213-1	3/4
14FF14	1413-1	7/8
16FF16	1613-1	1
20FF20	2013-1	1-1/4
24FF24	2413-1	1-1/2
32FF32	3213-1	2

Note: Ferrules are available in standard metal materials as well as standard plastics like PTFE and nylon. Please consult the factory for availability.

METRIC Front Ferrule *For metric tube*

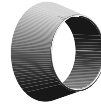

PARKER PART NO.	INTER-CHANGES WITH	MM TUBE O.D.
FFM2	2M3-1	2
FFM3	3M3-1	3
FFM4	4M3-1	4
FFM6	6M3-1	6
FFM8	8M3-1	8
FFM10	10M3-1	10
FFM12	12M3-1	12
FFM14	14M3-1	14
FFM15	15M3-1	15
FFM16	16M3-1	16
FFM18	18M3-1	18
FFM20	20M3-1	20
FFM22	22M3-1	22
FFM25	25M3-1	25

Note: Ferrules are available in standard metal materials as well as standard plastics like PTFE and nylon. Please consult the factory for availability.

INCH Back Ferrule *For fractional tube*



For stainless steel, sizes 4-32 are Suparcase ferrules.

PARKER PART NO.	INTER-CHANGES WITH	INCHES TUBE O.D.
1BF1	104-1	1/16
2BF2	204-1	1/8
3BF3	304-1	3/16
4BF4	404-1	1/4
5BF5	504-1	5/16
6BF6	604-1	3/8
8BF8	814-1	1/2
10BF10	1014-1	5/8
12BF12	1214-1	3/4
14BF14	1414-1	7/8
16BF16	1614-1	1
20BF20	2014-1	1-1/4
24BF24	2414-1	1-1/2
32BF32	3214-1	2

Note: Ferrules are available in standard metal materials as well as standard plastics like PTFE and nylon. Please consult the factory for availability.

METRIC Back Ferrule *For metric tube*



For stainless steel, sizes 6mm-25mm are Suparcase ferrules.

PARKER PART NO.	INTER-CHANGES WITH	MM TUBE O.D.
BFM2	2M4-1	2
BFM3	3M4-1	3
BFM4	4M4-1	4
BFM6	6M4-1	6
BFM8	8M4-1	8
BFM10	10M4-1	10
BFM12	12M4-1	12
BFM14	14M4-1	14
BFM15	15M4-1	15
BFM16	16M4-1	16
BFM18	18M4-1	18
BFM20	20M4-1	20
BFM22	22M4-1	22
BFM25	25M4-1	25

Note: Ferrules are available in standard metal materials as well as standard plastics like PTFE and nylon. Please consult the factory for availability.

Ferrule Holder

Package simplifies ordering, stocking, and assembling

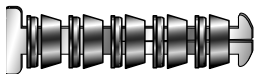

CPI™ PART NO.	A-LOK® PART NO.	INCHES TUBE O.D.
2 CPI-*-SET	2 ALOK-*-SET	1/8
4 CPI-*-SET	4 ALOK-*-SET	1/4
6 CPI-*-SET	6 ALOK-*-SET	3/8
8 CPI-*-SET	8 ALOK-*-SET	1/2
12 CPI-*-SET	12 ALOK-*-SET	3/4
16 CPI-*-SET	16 ALOK-*-SET	1

*Material designator – 316-SS, B-Brass, S-Steel

CPI™ PART NO.	A-LOK® PART NO.	MM TUBE O.D.
M6 CPI-*-SET	M6 ALOK-*-SET	6
M8 CPI-*-SET	M8 ALOK-*-SET	8
M10 CPI-*-SET	M10 ALOK-*-SET	10
M12 CPI-*-SET	M12 ALOK-*-SET	12

*Material designator – 316-SS, B-Brass, S-Steel



Cross section of an arbor with five nut ferrule sets

The Parker ferrule holder offers a new convenience. The holder contains individual ferrule sets. Ferrule sets may be dispensed one at a time.

NOTE: Assembled Nut and Ferrule Sets are available. Use designator NFS for the assembly of 5 sets per arbor.

Examples: 4A-NFS-316 (A-LOK® nut and ferrules set)
4Z-NFS-SS (CPI™ nut and ferrule set)

Components

Plug

For fractional tube

For plugging open ended CPI™/A-LOK® fitting ends

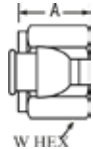

CPI™ PART NO.	A-LOK® PART NO.	INTER- CHANGES WITH	INCHES			
			TUBE O.D.	THREAD	A	W HEX
1 FNZ	1BLP1	100-P	1/16	10-32	0.31	5/16
2 FNZ	2BLP2	200-P	1/8	5/16-20	0.47	7/16
3 FNZ	3BLP3	300-P	3/16	3/8-20	0.47	1/2
4 FNZ	4BLP4	400-P	1/4	7/16-20	0.50	9/16
5 FNZ	5BLP5	500-P	5/16	1/2-20	0.53	5/8
6 FNZ	6BLP6	600-P	3/8	9/16-20	0.56	11/16
8 FNZ	8BLP8	810-P	1/2	3/4-20	0.69	7/8
10 FNZ	10BLP10	1010-P	5/8	7/8-20	0.69	1
12 FNZ	12BLP12	1210-P	3/4	1-20	0.69	1-1/8
14 FNZ	14BLP14	1410-P	7/8	1-1/8-20	0.69	1-1/4
16 FNZ	16BLP16	1610-P	1	1-5/16-20	0.81	1-1/2
20 FNZ	20BLP20	2010-P	1-1/4	1-5/8-20	1.35	1-7/8
24 FNZ	24BLP24	2410-P	1-1/2	1-15/16-20	1.72	2-1/4
32 FNZ	32BLP32	3210-P	2	2-5/8-20	2.27	3

Dimensions for reference only, subject to change.

HOW TO ASSEMBLE

Wrench tighten only 1/4 turn from finger tight position. Assembly includes machined ferrule with lock ring.

Single/Double Ferrule
Instrument Compression
Fittings

Plug

For metric tube

For plugging open ended CPI™/A-LOK® fitting ends

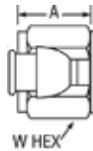

CPI™ PART NO.	A-LOK® PART NO.	INTER- CHANGES WITH	MILLIMETERS			
			TUBE O.D.	THREAD	A	W HEX
FNZ 2	BLPM2	2MO-P	2	5/16-20	11,9	12,0
FNZ 3	BLPM3	3MO-P	3	5/16-20	11,9	12,0
FNZ 4	BLPM4	4MO-P	4	3/8-20	11,9	12,0
FNZ 6	BLPM6	6MO-P	6	7/16-20	12,7	14,0
FNZ 8	BLPM8	8MO-P	8	1/2-20	13,5	16,0
FNZ 10	BLPM10	10MO-P	10	5/8-20	15,1	19,0
FNZ 12	BLPM12	12MO-P	12	3/4-20	17,5	22,0
FNZ 14	BLPM14	14MO-P	14	7/8-20	17,5	25,0
FNZ 15	BLPM15	15MO-P	15	7/8-20	17,5	25,0
FNZ 16	BLPM16	16MO-P	16	7/8-20	17,5	25,0
FNZ 18	BLPM18	18MO-P	18	1-20	17,5	30,0
FNZ 20	BLPM20	20MO-P	20	1-1/8-20	17,5	32,0
FNZ 22	BLPM22	22MO-P	22	1-1/8-20	17,5	32,0
FNZ 25	BLPM25	25MO-P	25	1-5/16-20	20,6	38,0

Dimensions for reference only, subject to change.

HOW TO ASSEMBLE

Wrench tighten only 1/4 turn from finger tight position. Assembly includes machined ferrule with lock ring.

Cap

For fractional tube

For capping open ended tubing

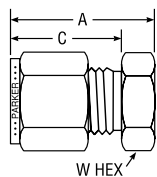
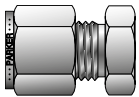

CPI™ PART NO.	A-LOK® PART NO.	INTER- CHANGES WITH	INCHES			
			TUBE O.D.	A	C	W HEX
1 PNBZ	1BLEN1	100-C	1/16	0.56	0.43	5/16
2 PNBZ	2BLEN2	200-C	1/8	0.79	0.60	7/16
3 PNBZ	3BLEN3	300-C	3/16	0.84	0.64	7/16
4 PNBZ	4BLEN4	400-C	1/4	0.92	0.70	1/2
5 PNBZ	5BLEN5	500-C	5/16	0.96	0.73	9/16
6 PNBZ	6BLEN6	600-C	3/8	1.01	0.76	5/8
8 PNBZ	8BLEN8	810-C	1/2	1.15	0.87	13/16
10 PNBZ	10BLEN10	1010-C	5/8	1.18	0.87	15/16
12 PNBZ	12BLEN12	1210-C	3/4	1.25	0.87	1-1/16
14 PNBZ	14BLEN14	1410-C	7/8	1.31	0.87	1-3/16
16 PNBZ	16BLEN16	1610-C	1	1.52	1.05	1-3/8
20 PNBZ	20BLEN20	2010-C	1-1/4	2.09	1.52	1-3/4
24 PNBZ	24BLEN24	2410-C	1-1/2	2.53	1.77	2-1/8
32 PNBZ	32BLEN32	3210-C	2	3.41	2.47	2-3/4

NOTE: For body only specify PNZ.

Dimensions for reference only, subject to change.

A and C dimensions are typical finger-tight.

Components

Cap

For metric tube

For capping open ended tubing

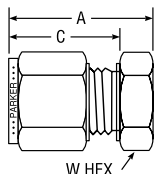
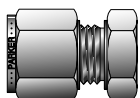

CPI™ PART NO.	A-LOK® PART NO.	INTER- CHANGES WITH	MILLIMETERS			
			TUBE O.D.	A	C	W HEX
PNBZ 2	BLENM2	2MO-C	2	20,1	15,3	12,0
PNBZ 3	BLENM3	3MO-C	3	19,8	15,0	12,0
PNBZ 4	BLENM4	4MO-C	4	20,6	15,8	12,0
PNBZ 6	BLENM6	6MO-C	6	23,4	17,8	14,0
PNBZ 8	BLENM8	8MO-C	8	24,6	18,6	15,0
PNBZ 10	BLENM10	10MO-C	10	26,7	19,5	18,0
PNBZ 12	BLENM12	12MO-C	12	29,2	22,1	22,0
PNBZ 14	BLENM14	14MO-C	14	29,9	22,0	24,0
PNBZ 15	BLENM15	15MO-C	15	29,9	22,0	24,0
PNBZ 16	BLENM16	16MO-C	16	29,9	22,0	24,0
PNBZ 18	BLENM18	18MO-C	18	31,4	22,0	27,0
PNBZ 20	BLENM20	20MO-C	20	34,0	22,0	30,0
PNBZ 22	BLENM22	22MO-C	22	34,0	22,0	30,0
PNBZ 25	BLENM25	25MO-C	25	38,4	26,5	35,0

NOTE: For body only specify PNZ.

Dimensions for reference only, subject to change.

A and C dimensions are typical finger-tight.

Vent Protector NPT Male Pipe Thread

For fractional tube

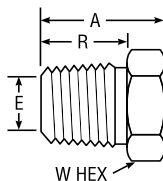

CPI™ PART NO.	INTER- CHANGES WITH	THREAD SIZE	INCHES			
			A	R	E MINIMUM OPENING	W HEX
2 MDF	MS-MD-2M	1/8-27	0.63	.38	.19	9/16
4 MDF	MS-MD-4M	1/4-18	0.81	.56	.28	9/16
6 MDF	MS-MD-6M	3/8-18	0.81	.56	.41	11/16
8 MDF	MS-MD-8M	1/2-14	1.06	.75	.50	7/8
12 MDF	MS-MD-12M	3/4-14	1.13	.75	.63	1-1/16
16 MDF	MS-MD-16M	1-11-1/2	1.31	.95	.94	1-3/8

Dimensions for reference only, subject to change.

Parker Instrumentation vent protectors (mud dauber fittings) protect open ends of instruments, tubing, outlet vents, etc. The mesh wire screen prevents foreign bodies such as insects or debris from entering and clogging various systems and causing damage.

- pipe plug, bored-thru design
- 40 x 40 mesh, .010 diameter wire screen
- designed to vent female pipe, straights, elbows or tees.

Color Coding

For easy reference, table column headings are color indicated as follows:

fractional



metric



Components

Sealing Washers

Bonded Seals

Consists of an outer stainless steel ring with a fluorocarbon inner ring used to seal a male ISO parallel thread.

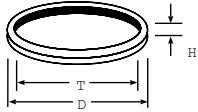

PARKER PART NO.	T BSPP THREAD	D	H
M30201-SS	1/8	0.63	.08
M30202-SS	1/4	0.81	.08
M30203-SS	3/8	0.94	.08
M30204-SS	1/2	1.12	.10
M30206-SS	3/4	1.38	.10
M30208-SS	1	1.69	.10

Simply replace Suffix SS with S

These seals are also available in steel with a nitrile inner ring.

PRESSURE RATINGS FOR SEALING WASHER		
THREAD SIZE	PSI	BAR
1/8	5300	370
1/4	5500	380
3/8	4400	300
1/2	4000	280
3/4	3700	260
1	2800	190

Dimensions for reference only, subject to change.

Copper Washers

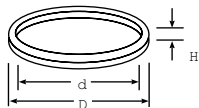

For BSPP male thread sealing

PARKER PART NO.	THREAD	D	d	H
M28329-CU	1/8	0.71	0.39	.09
M28330-CU	1/4	0.87	0.55	.09
M28331-CU	3/8	0.94	0.67	.09
M28332-CU	1/2	1.18	0.87	.10
M28334-CU	3/4	1.38	1.06	.09
M28336-CU	1	1.65	1.34	.09

For BSPP female thread sealing

PARKER PART NO.	THREAD	D	d	H
M25179-CU	1/8	0.322	.188	.062
M25180-CU	1/4	0.436	.250	.062
M25181-CU	3/8	0.574	.375	.062
M25182-CU	1/2	0.719	.500	.062
M25184-CU	3/4	0.935	.719	.062
M25186-CU	1	1.178	.969	.093

Dimensions for reference only, subject to change.

Used to provide a seal with male or female parallel ISO threads.

Please note the pressure ratings are based on taper threaded ends. The pressure rating for the BSPP ends are dependent on the type of sealing washer used.

Color Coding

For easy reference, table column headings are color indicated as follows:

fractional



metric



Components

Single/Double Ferrule
Instrument Compression
Fittings

Bulkhead Locknut For fractional tube

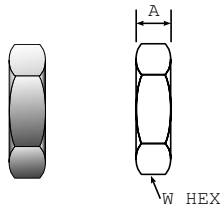

PARKER PART NO.	INTER-CHANGES WITH	INCHES			
		A-LOK® THREAD	TUBE O.D.	A	W HEX
1 WLZ	102-61	10-32	1/16	.13	5/16
2 WLZ	202-61	5/16-20	1/8	.19	1/2
3 WLZ	302-61	3/8-20	3/16	.22	9/16
4 WLZ	402-61	7/16-20	1/4	.22	5/8
5 WLZ	502-61	1/2-20	5/16	.23	11/16
6 WLZ	602-61	9/16-20	3/8	.25	3/4
8 WLZ	812-61	3/4-20	1/2	.28	15/16
10 WLZ	1012-61	7/8-20	5/8	.31	1-1/16
12 WLZ	1212-61	1"-20	3/4	.34	1-3/16
14 WLZ	1412-61	1-1/8-20	7/8	.38	1-3/8
16 WLZ	1612-61	1-5/16-20	1	.38	1-5/8

Dimensions for reference only, subject to change.

Bulkhead Locknut For fractional tube

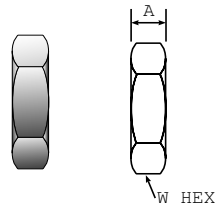

PARKER PART NO.	INCHES			
	SAE ADJ. STR. THREAD	TUBE O.D.	A	W HEX
4 WLN	7/16-20	1/4	.28	11/16
6 WLN	9/16-18	3/8	.27	13/16
8 WLN	3/4-16	1/2	.31	1
12 WLN	1-1/16-12	3/4	.41	1-3/8
16 WLN	1-5/16-12	1	.41	1-5/8

Dimensions for reference only, subject to change.

Bulkhead Locknut For metric tube

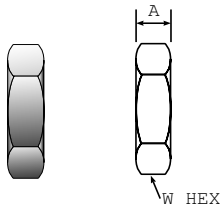

PARKER PART NO.	MILLIMETERS			
	SAE ADJ. STR. THREAD	TUBE O.D.	A	W HEX
2BN2	5/16-20	2 & 3	4,8	13,0
3BN3	3/8-20	4	5,6	14,0
4BN4	7/16-20	6	5,6	16,0
5BN5	1/2-20	8	5,6	17,0
BNM10	5/8-20	10	6,4	21,0
8BN8	3/4-20	12	7,1	24,0
10BN10	7/8-20	14, 15 & 16	7,9	27,0
12BN12	1-20	18	8,6	30,0
14BN14	1-1/8-20	20 & 22	9,7	33,0
16BN16	1-5/16-20	25	9,7	41,0

Dimensions for reference only, subject to change.

Accessory Locknut

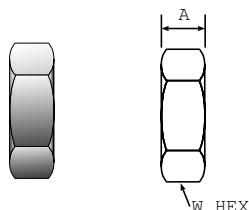

PARKER PART NO.	INCHES		
	STRAIGHT THREAD	A	W HEX
2 L5NR	5/16-24	.22	7/16
3 L5NR	3/8-24	.22	1/2
4 L5NR	7/16-20	.28	9/16
5 L5NR	1/2-20	.28	5/8
6 L5NR	9/16-18	.28	11/16
8 L5NR	3/4-16	.31	7/8
10 L5NR	7/8-14	.36	1
12 L5NR	1-1/16-12	.41	1-1/4
14 L5NR	1-3/16-12	.41	1-3/8
16 L5NR	1-5/16-12	.41	1-1/2

Dimensions for reference only, subject to change.

NOTE: For use with M2SC and M2TU fittings on pages 87 and 88.

Assembly & Remake Instructions

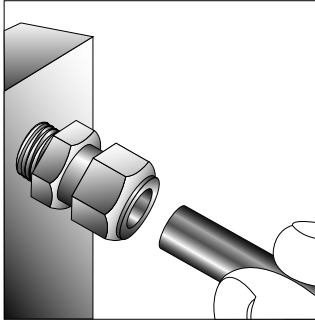

INCH SIZE 1 thru 3
(1/16" - 3/16")
METRIC SIZE 2 thru 4
(2-4mm)

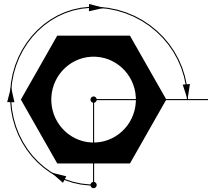

Only 3/4 turn from finger tight is necessary to seal and will result in additional remakes of the fitting

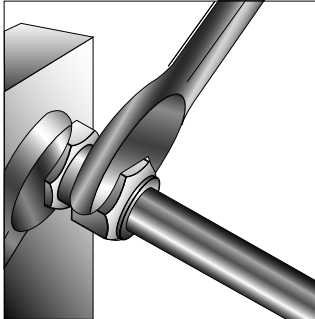

INCH SIZE 4 thru 16
(1/4" - 1")
METRIC SIZE 6 thru 25
(6-25mm)

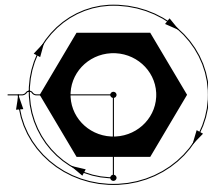

1-1/4 Turns from
Finger Tight

1. Parker instrument tube fittings are sold completely assembled and ready for immediate use. Simply insert the tube as illustrated until it bottoms in the fitting body. (If the fitting is disassembled, note that the small tapered end of the ferrule(s) go into the fitting body.)
2. Tighten nut finger tight. Then tighten nut with wrench an additional 3/4 or 1-1/4 turns indicated at left. Hold fitting body with a second wrench to prevent body from turning. It is helpful to mark the nut to facilitate counting the number of turns.

For maximum number of remakes, mark the fitting and nut before disassembly. Before retightening, make sure the assembly has been inserted into the fitting until the ferrule seats in the fitting. Retighten the nut by hand. Rotate the nut with a wrench to the original position as indicated by the previous marks lining up. (A noticeable increase in mechanical resistance will be felt indicating the ferrule is being re-sprung into sealing position.)

Only after several remakes will it become necessary to advance the nut slightly past the original position. This advance (indicated by B) need only be 10° - 20° (less than 1/3 of a hex flat).

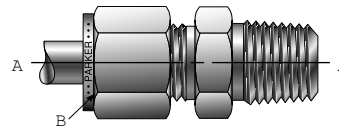

Parker CPI™/A-LOK® Tube Fitting part numbers use symbols to identify the size, style, and material. Tube and pipe thread sizes begin with a number indicating their size in sixteenths of an inch. For example, 4=4/16" or 1/4"; 16=16/16" or 1.

NOTES: 1. Lubrication of the nut is **REQUIRED** for proper assembly on all **LARGER** size fittings in both inch and metric sizes. This requirement applies to:

- inch sizes of 20 and higher
- metric sizes of 25 and higher

2. Parker recommends the use of pre-assembly tools for certain tube/fitting combinations. Please refer to Tubing Material Tables on p. 23-31 for further information.

Gaugeability Instructions*

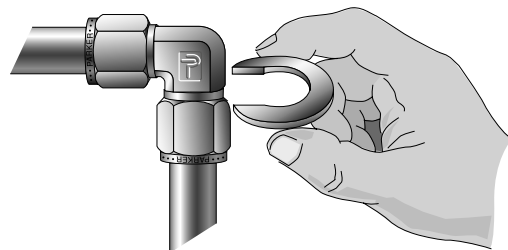
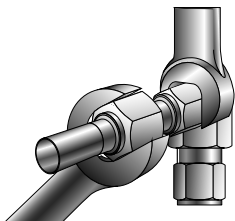

1. From "finger tight" position, wrench 1-1/4 turns for 1/4" to 1" size fittings (6mm to 25mm) (1/16", 1/8", 3/16", 2mm 3mm and 4mm size tube fittings only wrench 3/4 turn from finger tight position). Hold fitting body hex with second wrench to prevent body from turning as you tighten. It is a good idea to mark the nut (scribe or ink) to help you count the turns.

2. Now select the proper size inspection gauge and try to place it, as shown, between the nut and the body hex. If gauge **DOES NOT FIT AT ANY POINT** between them, you have correctly tightened the nut. If you can slip the gauge into the space, the fitting is not properly made up, and you must repeat the assembly procedure.

*For initial make up only.

Instrument Pipe Fittings

Visual Index

Pipe Fittings

Male Hex Nipple
MHN
page 111



Male Close Nipple
MCN
page 111



Male Hex Long Nipple
MHLN
page 112



Female Hex Coupling
FHC
page 112



Adapter
RA
page 113



Reducing Bushing
RB
page 113



Male Elbow
ME
page 114



Female Elbow
FE
page 114



Female Elbow 45°
FVE
page 114



Street Elbow
SE
page 115



Street Elbow 45°
SVE
page 115



Male Tee
MT
page 116



Female Tee
FT
page 116



Street Tee
ST
page 117



Male Branch Tee
MBT
page 117



Female Cross
FX
page 117



Pipe Cap
CP
page 118



Hex Head Plug
PH
page 118



Hollow Hex Plug
PHH
page 118



Straight Thread Adapters

Hex Head Plug
P5ON
page 119



Hollow Hex Plug
HP5ON
page 119



Straight Thread Reducer/Expander
F5OG5
page 119



Male SAE Straight Thread to Female NPT Thread
GOA
page 120

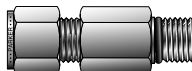

Male Connector to SAE Straight Thread
page 120

Pipe Data and Dimensions
page 134

Instrument Pipe and ISO Conversion Fittings

Instrument Pipe Fittings

Features and Technical Data

Parker Instrument Pipe Fittings are precision machined from forgings for elbows, tees and crosses and from bar stock for straight connectors. They are designed to be used for process control and instrumentation connections between pipe sizes and tube sizes.

Features

- Quality engineered for instrumentation applications
- Packaged in sealed, clear plastic shrink wrapped boxes for cleanliness
- Working pressures calculated in accordance with Power Piping Code ANSI B31.1 and Refiner Piping Code ANSI B31.3.
- All pipe threads are National Pipe Taper (NPT) and exceed the requirements of ANSI B1.20.1.
- Rolled male threads for extra strength
- Straight bodies machined from applicable ASTM bar stock specifications
- Shapes machined from close grain forgings
- Size ranges from 1/16" through 2" NPT
- Materials – 316 Stainless Steel, Brass and Steel. (Other materials by special order)
- All exposed threads protected to prevent damage

Pipe Dimensions

Pipe Size	N.P.T. Pipe Thread	R	E Ref.
1/16	1/16 – 27	.38	.11
1/8	1/8 – 27	.38	.19
1/4	1/4 – 18	.56	.28
3/8	3/8 – 18	.56	.41
1/2	1/2 – 14	.75	.50
3/4	3/4 – 14	.75	.62
1	1 – 11-1/2	.94	.94
1-1/4	1-1/4 – 11-1/2	.97	1.25
1-1/2	1-1/2 – 11-1/2	1.00	1.50
2	2 – 11-1/2	1.03	1.94

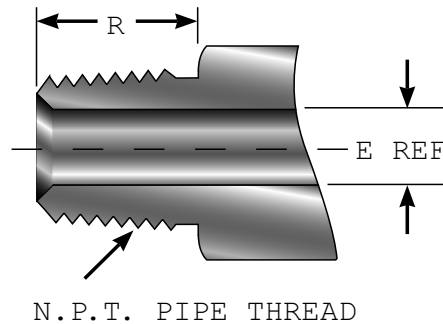

NPT Threads

The National Pipe Taper (NPT) thread has a thread flank angle of 60° inclusive, and is mainly used in the petrochemical and process industries.

NPT – National Pipe Taper threads for connections where pressure-tight joints are made on the threads utilizing a thread sealant.

Generic Thread

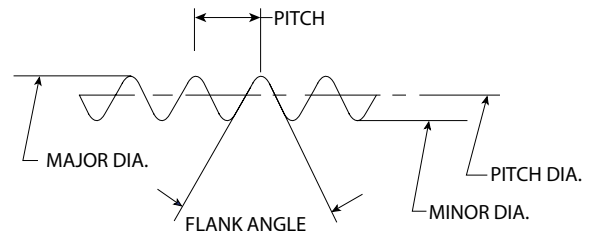

Instrument Pipe Fittings

How To Order

Parker Instrument Pipe Fittings part numbers are constructed from symbols that identify the size and style of the fitting and material used.

The example shown below describes a male hex nipple for 3/8" NPT male pipe and 1/4" NPT male pipe in 316 stainless steel.

Example: 6-4 MHN-SS

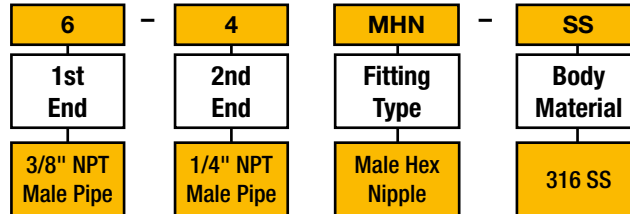

Parker Instrument Pipe Fittings are ordered by part number as listed in this catalog.

Size: Pipe thread sizes are designated by the number of sixteenths of an inch.
(3/8 NPT pipe = $6/16 = 6$)

Thread Type: All pipe threads are National Pipe Taper (NPT) unless otherwise designated.

Straights and Elbows: Call out the largest pipe end first followed by the smaller pipe size. See MHN example on page 4.

Tees and Crosses: For tees that are the same pipe sizes on all ends the size designation is shown below:

Example: 6-6-6 FT-B would be a 3/8" NPT Female Tee in brass.

Example: 4 FX-SS would be a 1/4" NPT Female Cross in 316 SS.

If a reducing tee or cross were specified, each size must be in sequence. First size the largest run (1 to 2) and then the branch (3 to 4).

Example: 6-6-6-4 FX-SS

Material: Basic Material Type (B = Brass, SS = 316 Stainless Steel, S = Steel)

Special Fittings: If there is any question as to the fitting desired, particularly for special fitting configurations, it is suggested that a customer print be submitted with the fitting request for quote.

Availability: Items priced in current Price List 4260 are carried in stock. Price and delivery for non-standard items quoted on request through the quick response department.

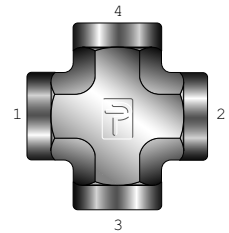

Instrument Pipe Fittings

Male Hex Nipple MHN

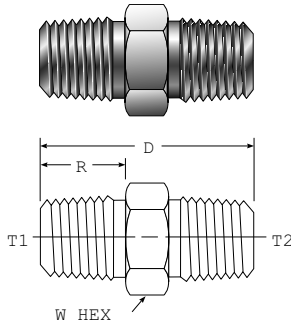

Parker Part No.	NPT Thread Male		W Hex	D (in.)	R (in.)	Working Pressures (PSIG)		
	T ₁	T ₂				Brass	Stainless Steel	Steel
1-1 MHN	1/16	1/16	7/16	1.06	.38	6000	10000	10500
2-1 MHN	1/8	1/16	7/16	1.06	.38	5600	9100	9700
2-2 MHN	1/8	1/8	7/16	1.06	.38	5600	9100	9700
4-1 MHN	1/4	1/16	5/8	1.25	.56/.38	4100	7500	8000
4-2 MHN	1/4	1/8	5/8	1.25	.56/.38	4100	7500	8000
4-4 MHN	1/4	1/4	5/8	1.45	.56	4100	7500	8000
6-1 MHN	3/8	1/16	3/4	1.27	.56/.38	4000	7200	7600
6-2 MHN	3/8	1/8	3/4	1.27	.56/.38	4000	7200	7600
6-4 MHN	3/8	1/4	3/4	1.45	.56	4000	7200	7600
6-6 MHN	3/8	3/8	3/4	1.45	.56	4000	7200	7600
8-2 MHN	1/2	1/8	7/8	1.52	.75/.38	3900	6600	7000
8-4 MHN	1/2	1/4	7/8	1.70	.75/.56	3900	6600	7000
8-6 MHN	1/2	3/8	7/8	1.70	.75/.56	3900	6600	7000
8-8 MHN	1/2	1/2	7/8	1.89	.75	3900	6600	7000
12-2 MHN	3/4	1/8	1-1/8	1.59	.75/.38	3800	6400	6800
12-4 MHN	3/4	1/4	1-1/8	1.78	.75/.56	3800	6400	6800
12-6 MHN	3/4	3/8	1-1/8	1.78	.75/.56	3800	6400	6800
12-8 MHN	3/4	1/2	1-1/8	1.97	.75	3800	6400	6800
12-12 MHN	3/4	3/4	1-1/8	1.97	.75	3800	6400	6800
16-2 MHN	1	1/8	1-3/8	1.78	.94/.38	2700	4600	4900
16-4 MHN	1	1/4	1-3/8	1.97	.94/.56	2700	4600	4900
16-6 MHN	1	3/8	1-3/8	1.97	.94/.56	2700	4600	4900
16-8 MHN	1	1/2	1-3/8	2.16	.94/.75	2700	4600	4900
16-12 MHN	1	3/4	1-3/8	2.09	.94/.75	2700	4600	4900
16-16 MHN	1	1	1-3/8	2.34	.94	2700	4600	4900
20-16 MHN	1-1/4	1	1-3/4	2.45	.97/.94	2000	3500	3700
20-20 MHN	1-1/4	1-1/4	1-3/4	2.48	.97	2000	3500	3700
24-24 MHN	1-1/2	1-1/2	2	2.61	1.00	1800	2900	3100

Instrument Pipe and ISO Conversion Fittings

Male Close Nipple MCN

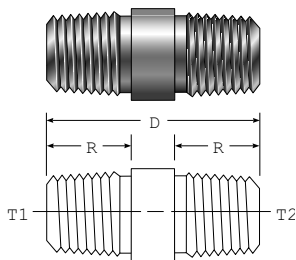

Parker Part No.	NPT Thread Male	D (in.)	R (in.)	Working Pressure (PSIG)		
				Brass	Stainless Steel	Steel
1-1 MCN	1/16	.75	.34	6000	10000	10500
2-2 MCN	1/8	.75	.34	5600	9100	9700
4-4 MCN	1/4	1.13	.49	4100	7500	8000
6-6 MCN	3/8	1.13	.48	4000	7200	7600
8-8 MCN	1/2	1.50	.66	3900	6600	7000
12-12 MCN	3/4	1.50	.66	3800	6400	6800
16-16 MCN	1	1.88	.84	2700	4600	4900

Dimensions for reference only, subject to change.

Instrument Pipe Fittings

Male Hex Long Nipple MHLN

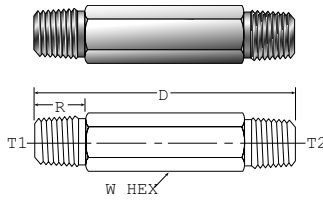

Parker Part No.	NPT Thread Male		W Hex	D (in.)	R (in.)	Working Pressure (PSIG)		
	T ₁	T ₂				Brass	Stainless Steel	Steel
1-1 MHLN-(**) (*)	1/16	1/16	7/16	*	.38	6000	10000	10500
2-2 MHLN-(**) (*)	1/8	1/8	7/16	*	.38	5600	9100	9700
2-2 MHLN-(**) 1.5	1/8	1/8	7/16	1.50	.38	5600	9100	9700
2-2 MHLN-(**) 2.0	1/8	1/8	7/16	2.00	.38	5600	9100	9700
2-2 MHLN-(**) 2.5	1/8	1/8	7/16	2.50	.38	5600	9100	9700
4-4 MHLN-(**) (*)	1/4	1/4	5/8	*	.56	4100	7500	8000
4-4 MHLN-(**) 2.0	1/4	1/4	5/8	2.00	.56	4100	7500	8000
4-4 MHLN-(**) 2.5	1/4	1/4	5/8	2.50	.56	4100	7500	8000
4-4 MHLN-(**) 3.0	1/4	1/4	5/8	3.00	.56	4100	7500	8000
4-4 MHLN-(**) 4.0	1/4	1/4	5/8	4.00	.56	4100	7500	8000
6-6 MHLN-(**) (*)	3/8	3/8	3/4	*	.56	4000	7200	7600
8-8 MHLN-(**) (*)	1/2	1/2	7/8	*	.75	3900	6600	7000
8-8 MHLN-(**) 2.0	1/2	1/2	7/8	2.00	.75	3900	6600	7000
8-8 MHLN-(**) 3.0	1/2	1/2	7/8	3.00	.75	3900	6600	7000

*Specify Length

** Specify Material (B = Brass, SS = Stainless Steel, S = Steel)

Female Hex Coupling FHC

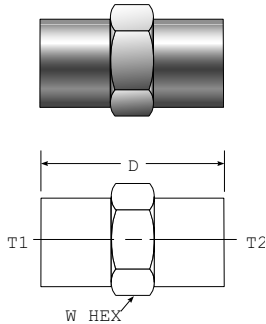

Parker Part No.	NPT Thread Female		W Hex	D (in.)	Working Pressures (PSIG)		
	T ₁	T ₂			Brass	Stainless Steel	Steel
1-1 FHC	1/16	1/16	1/2	.75	4500	7500	8000
2-1 FHC	1/8	1/16	5/8	.75	4000	6400	6800
2-2 FHC	1/8	1/8	5/8	.75	4000	6400	6800
4-1 FHC	1/4	1/16	3/4	.92	4300	6600	7000
4-2 FHC	1/4	1/8	3/4	.94	4300	6600	7000
4-4 FHC	1/4	1/4	3/4	1.13	4300	6600	7000
6-1 FHC	3/8	1/16	7/8	.95	3500	5300	5600
6-2 FHC	3/8	1/8	7/8	1.03	3500	5300	5600
6-4 FHC	3/8	1/4	7/8	1.13	3500	5300	5600
6-6 FHC	3/8	3/8	7/8	1.13	3500	5300	5600
8-2 FHC	1/2	1/8	1-1/8	1.22	3600	5200	5500
8-4 FHC	1/2	1/4	1-1/8	1.38	3600	5200	5500
8-6 FHC	1/2	3/8	1-1/8	1.50	3600	5200	5500
8-8 FHC	1/2	1/2	1-1/8	1.50	3600	5200	5500
12-2 FHC	3/4	1/8	1-3/8	1.39	3000	4300	4600
12-4 FHC	3/4	1/4	1-3/8	1.55	3000	4300	4600
12-6 FHC	3/4	3/8	1-3/8	1.69	3000	4300	4600
12-8 FHC	3/4	1/2	1-3/8	1.88	3000	4300	4600
12-12 FHC	3/4	3/4	1-3/8	1.53	3000	4300	4600
16-2 FHC	1	1/8	1-5/8	1.44	3100	4500	4800
16-4 FHC	1	1/4	1-5/8	1.63	3100	4500	4800
16-6 FHC	1	3/8	1-5/8	1.63	3100	4500	4800
16-8 FHC	1	1/2	1-5/8	1.77	3100	4500	4800
16-12 FHC	1	3/4	1-5/8	1.72	3100	4500	4800
16-16 FHC	1	1	1-5/8	1.89	3100	4500	4800
20-16 FHC	1-1/4	1	2	1.94	2300	3500	3700
20-20 FHC	1-1/4	1-1/4	2	1.94	2300	3500	3700
24-24 FHC	1-1/2	1-1/2	2-3/8	1.94	2100	3200	3400

Dimensions for reference only, subject to change.

Instrument Pipe Fittings

Adapter RA

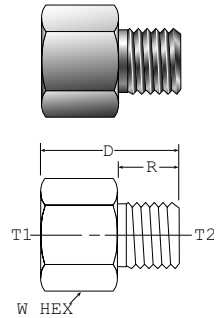

Parker Part No.	NPT Thread		W Hex	D (in.)	R (in.)	Working Pressures (PSIG)		
	Female T ₁	Male T ₂				Brass	Stainless Steel	Steel
2-1 RA	1/8	1/16	5/8	1.03	.38	4000	6400	6800
2-2 RA	1/8	1/8	5/8	1.03	.38	4000	6400	6800
4-1 RA	1/4	1/16	3/4	1.20	.38	4300	6600	7000
4-2 RA	1/4	1/8	3/4	1.20	.38	4300	6600	7000
4-4 RA	1/4	1/4	3/4	1.39	.56	4300	6600	7000
6-1 RA	3/8	1/16	7/8	1.25	.38	3500	5300	5600
6-2 RA	3/8	1/8	7/8	1.25	.38	3500	5300	5600
6-4 RA	3/8	1/4	7/8	1.44	.56	3500	5300	5600
6-6 RA	3/8	3/8	7/8	1.44	.56	3500	5300	5600
8-2 RA	1/2	1/8	1-1/8	1.50	.38	3600	5200	5500
8-4 RA	1/2	1/4	1-1/8	1.69	.56	3600	5200	5500
8-6 RA	1/2	3/8	1-1/8	1.69	.56	3600	5200	5500
8-8 RA	1/2	1/2	1-1/8	1.88	.75	3600	5200	5500
12-2 RA	3/4	1/8	1-3/8	1.56	.38	3000	4300	4600
12-4 RA	3/4	1/4	1-3/8	1.75	.56	3000	4300	4600
12-6 RA	3/4	3/8	1-3/8	1.75	.56	3000	4300	4600
12-8 RA	3/4	1/2	1-3/8	1.94	.75	3000	4300	4600
16-2 RA	1	1/8	1-5/8	1.81	.38	3100	4500	4800
16-4 RA	1	1/4	1-5/8	2.00	.56	3100	4500	4800
16-6 RA	1	3/8	1-5/8	2.00	.56	3100	4500	4800
16-8 RA	1	1/2	1-5/8	2.19	.75	3100	4500	4800
16-12 RA	1	3/4	1-5/8	2.19	.75	3100	4500	4800
16-16 RA	1	1	1-5/8	2.38	.94	2700	4500	4800
20-16 RA	1-1/4	1	2	2.47	.94	2300	3500	3700

Reducing Bushing RB

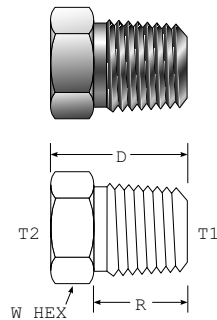

Parker Part No.	NPT Thread		W Hex	D (in.)	R (in.)	Working Pressures (PSIG)		
	Male T ₁	Female T ₂				Brass	Stainless Steel	Steel
2-1 RB	1/8	1/16	7/16	.63	.38	2900	6400	6800
4-1 RB	1/4	1/16	5/8	.86	.56	4100	7500	8000
4-2 RB	1/4	1/8	5/8	.86	.56	3600	6000	6400
6-1 RB	3/8	1/16	3/4	.86	.56	4000	7200	7600
6-2 RB	3/8	1/8	3/4	.86	.56	4000	6400	6800
6-4 RB	3/8	1/4	3/4	.86	.56	3000	5300	5600
8-2 RB	1/2	1/8	7/8	1.11	.75	3900	6600	6800
8-4 RB	1/2	1/4	7/8	1.11	.75	3900	6400	7000
8-6 RB	1/2	3/8	7/8	1.11	.75	2800	4600	4900
12-2 RB	3/4	1/8	1-1/8	1.17	.75	3800	6400	6800
12-4 RB	3/4	1/4	1-1/8	1.17	.75	3800	6400	6800
12-6 RB	3/4	3/8	1-1/8	1.17	.75	3500	5300	5600
12-8 RB	3/4	1/2	1-1/8	1.17	.75	2800	4900	5200
16-2 RB	1	1/8	1-3/8	1.36	.94	2700	4600	4900
16-4 RB	1	1/4	1-3/8	1.36	.94	2700	4600	4900
16-6 RB	1	3/8	1-3/8	1.36	.94	2700	4600	4900
16-8 RB	1	1/2	1-3/8	1.36	.94	2700	4600	4900
16-12 RB	1	3/4	1-3/8	1.36	.94	2500	4200	4500
20-12 RB	1-1/4	3/4	1-3/4	1.47	.97	2000	3500	3700
20-16 RB	1-1/4	1	1-3/4	1.47	.97	2000	3500	3700
24-16 RB	1-1/2	1	2	1.58	1.00	1800	2900	3100
24-20 RB	1-1/2	1-1/4	2	1.58	1.00	1700	2700	2800

Dimensions for reference only, subject to change.

Instrument Pipe Fittings

Male Elbow ME

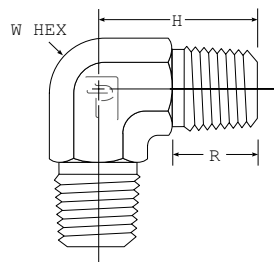
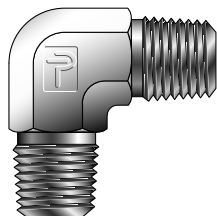

Parker Part No.	NPT Thread Male	W Hex	H (in.)	R (in.)	Working Pressures (PSIG)		
					Brass	Stainless Steel	Steel
1-1 ME	1/16	3/8	.66	.38	5500	9500	10100
2-2 ME	1/8	7/16	.76	.38	5000	9100	9700
4-4 ME	1/4	9/16	1.09	.56	4100	7500	8000
6-6 ME	3/8	3/4	1.22	.56	4000	7200	7600
8-8 ME	1/2	7/8	1.47	.75	3100	5800	6200
12-12 ME	3/4	1-1/16	1.59	.75	3400	6400	6800
16-16 ME	1	1-5/16	1.97	.94	2700	4600	4900

Female Elbow FE

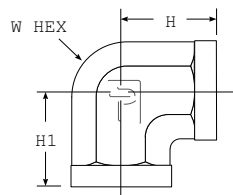

Parker Part No.	NPT Thread Female	W Hex	H (in.)	H ₁ (in.)	Working Pressures (PSIG)		
					Brass	Stainless Steel	Steel
1-1 FE	1/16	7/16	.50	.50	3800	7000	7500
2-1 FE	1/8 - 1/16	9/16	.66	.66	2900	5500	5900
2-2 FE	1/8	9/16	.66	.66	2900	5500	5900
4-2 FE	1/4 - 1/8	3/4	.88	.88	2900	5500	5900
4-4 FE	1/4	3/4	.88	.88	3000	5600	6000
6-6 FE	3/8	7/8	1.02	1.02	2700	5000	5300
8-8 FE	1/2	1-1/16	1.23	1.23	2500	4500	4800
12-12 FE	3/4	1-5/16	1.36	1.36	2000	3500	3700
16-16 FE	1	1-5/8	1.63	1.63	2300	3900	4200
20-20 FE	1-1/4	1-7/8	1.70	1.70	1900	3100	3300
24-24 FE	1-1/2	2-1/2	2.08	2.08	1700	2500	2600

Female Elbow 45° FVE

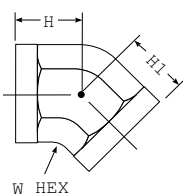

Parker Part No.	NPT Thread Female	W Hex	H (in.)	H ₁ (in.)	Working Pressures (PSIG)		
					Brass	Stainless Steel	Steel
1-1 FVE	1/16	7/16	.47	.47	3800	7000	7500
2-2 FVE	1/8	9/16	.47	.47	2900	5500	5900
4-4 FVE	1/4	3/4	.69	.69	3000	5600	6000
6-6 FVE	3/8	7/8	.75	.75	2700	5000	5300
8-8 FVE	1/2	1-1/16	.94	.94	2500	4500	4800
12-12 FVE	3/4	1-5/16	1.00	1.00	2000	3500	3700
16-16 FVE	1	1-5/8	1.19	1.19	2300	3900	4200

Dimensions for reference only, subject to change.

Instrument Pipe Fittings

Street Elbow SE

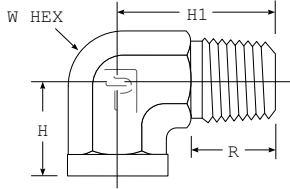
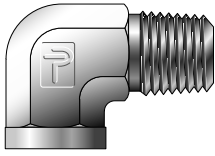

Parker Part No.	NPT Thread		W Hex	H (in.)	H ₁ (in.)	R (in.)	Working Pressures (PSIG)		
	Male	Female					Brass	Stainless Steel	Steel
1-1 SE	1/16	1/16	9/16	.66	.72	.38	3800	7000	7500
2-1 SE	1/8	1/16	9/16	.66	.78	.38	3800	7000	7500
2-2 SE	1/8	1/8	9/16	.66	.78	.38	2900	5500	5900
4-1 SE	1/4	1/16	9/16	.66	1.09	.56	3800	7000	7500
4-2 SE	1/4	1/8	9/16	.66	1.09	.56	2900	5500	5900
4-4 SE	1/4	1/4	3/4	.88	1.09	.56	3000	5600	6000
6-1 SE	3/8	1/16	3/4	.88	1.09	.56	3800	7000	7500
6-2 SE	3/8	1/8	3/4	.88	1.22	.58	2900	5500	5900
6-4 SE	3/8	1/4	3/4	.88	1.22	.56	3000	5600	6000
6-6 SE	3/8	3/8	7/8	1.02	1.22	.56	2700	5000	5300
8-2 SE	1/2	1/8	7/8	.95	1.47	.75	2900	5500	5900
8-4 SE	1/2	1/4	7/8	.95	1.47	.75	3000	5600	6000
8-6 SE	1/2	3/8	7/8	1.23	1.47	.75	2700	5000	5300
8-8 SE	1/2	1/2	1-1/16	1.23	1.47	.75	2500	4500	4800
12-2 SE	3/4	1/8	1-1/16	1.00	1.59	.75	2900	5500	5900
12-4 SE	3/4	1/4	1-1/16	1.00	1.59	.75	3000	5600	6000
12-6 SE	3/4	3/8	1-1/16	1.23	1.59	.75	2700	5000	5300
12-8 SE	3/4	1/2	1-1/16	1.23	1.59	.75	2500	4500	4800
12-12 SE	3/4	3/4	1-5/16	1.36	1.59	.75	2000	3500	3700
16-2 SE	1	1/8	1-5/16	1.63	1.97	.94	2700	5500	5900
16-4 SE	1	1/4	1-5/16	1.63	1.97	.94	2700	5600	6000
16-6 SE	1	3/8	1-5/16	1.50	1.97	.94	2700	5000	5300
16-8 SE	1	1/2	1-5/16	1.63	1.97	.94	2500	4500	4800
16-12 SE	1	3/4	1-5/16	1.36	1.97	.94	2000	3500	3700
16-16 SE	1	1	1-5/8	1.63	1.97	.94	2300	3900	4200
20-20 SE	1-1/4	1-1/4	1-7/8	1.70	2.38	.97	1900	3100	3300

Instrument Pipe and ISO
Conversion Fittings

Street Elbow 45° SVE

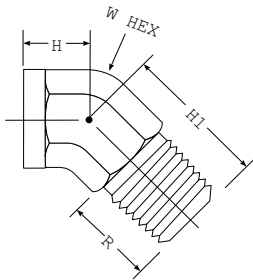
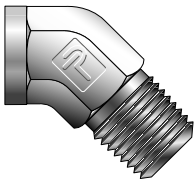

Parker Part No.	NPT Thread		W Hex	H (in.)	H ₁ (in.)	R (in.)	Working Pressures (PSIG)		
	Male	Female					Brass	Stainless Steel	Steel
1-1 SVE	1/16	1/16	7/16	.47	.66	.38	3800	7000	7500
2-2 SVE	1/8	1/8	9/16	.47	.72	.38	2900	5500	5900
4-4 SVE	1/4	1/4	3/4	.63	1.05	.56	3000	5600	6000
6-6 SVE	3/8	3/8	7/8	.72	1.06	.56	2700	5000	5300
8-8 SVE	1/2	1/2	1-1/16	.91	1.34	.75	2500	4500	4800
12-12 SVE	3/4	3/4	1-5/16	.97	1.38	.75	2000	3500	3700
16-16 SVE	1	1	1-5/8	1.13	1.72	.94	2300	3900	4200

Dimensions for reference only, subject to change.

Instrument Pipe Fittings

Male Tee MT

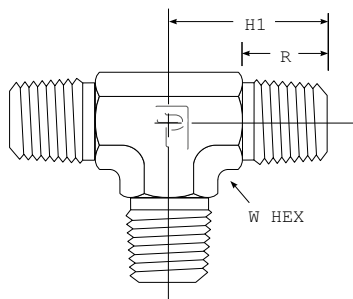
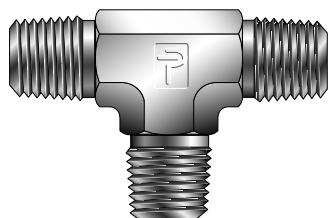

Parker Part No.	NPT Thread Male	W Hex	H ₁ (in.)	R (in.)	Working Pressures (PSIG)		
					Brass	Stainless Steel	Steel
1-1-1 MT	1/16	5/16	.72	.38	5500	10100	9500
2-2-2 MT	1/8	7/16	.76	.38	5000	9700	9100
4-4-4 MT	1/4	9/16	1.09	.56	4100	8000	7500
6-6-6 MT	3/8	3/4	1.22	.56	4000	7600	7200
8-8-8 MT	1/2	7/8	1.47	.75	3100	6200	5800
12-12-12 MT	3/4	1-1/16	1.59	.75	3400	6800	6400
16-16-16 MT	1	1-5/16	1.97	.94	2700	4900	4600
20-20-20 MT	1-1/4	1-5/8	2.22	.97	2000	3700	3500
24-24-24 MT	1-1/2	1-7/8	2.64	1.00	1800	3100	2900

Female Tee FT

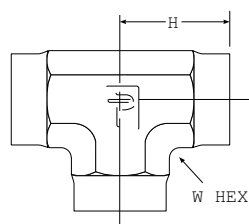

Parker Part No.	NPT Thread Female	W Hex	H (in.)	Working Pressures (PSIG)		
				Brass	Stainless Steel	Steel
1-1-1 FT	1/16	7/16	.50	3800	7000	7500
2-2-2 FT	1/8	9/16	.66	2900	5500	5900
4-4-4 FT	1/4	3/4	.88	3000	5600	6000
6-6-6 FT	3/8	7/8	1.02	2700	5000	5300
8-8-8 FT	1/2	1-1/16	1.23	2500	4500	4800
12-12-12 FT	3/4	1-5/16	1.36	2000	3500	3700
16-16-16 FT	1	1-5/8	1.63	2300	3900	4200
20-20-20 FT	1-1/4	1-7/8	1.70	1900	3100	3300
24-24-24 FT	1-1/2	2-1/2	2.08	1700	2500	3600

Dimensions for reference only, subject to change.

Instrument Pipe Fittings

Street Tee ST

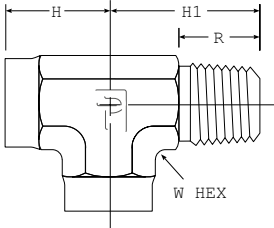
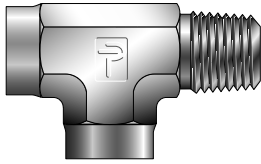

Parker Part No.	NPT Thread		W Hex	H (in.)	H ₁ (in.)	R (in.)	Working Pressures (PSIG)		
	Male	Female					Brass	Stainless Steel	Steel
1-1-1 ST	1/16	1/16	7/16	.50	.72	.38	3800	7000	7500
2-2-2 ST	1/8	1/8	9/16	.66	.78	.38	2900	5500	5900
4-4-4 ST	1/4	1/4	3/4	.88	1.09	.56	3000	5600	6000
6-6-6 ST	3/8	3/8	7/8	1.02	1.22	.56	2700	5000	5300
8-8-8 ST	1/2	1/2	1-1/16	1.23	1.47	.75	2500	4500	4800
12-12-12 ST	3/4	3/4	1-5/16	1.36	1.59	.75	2000	3500	3700
16-16-16 ST	1	1	1-5/8	1.63	1.97	.94	2300	3900	4200

Male Branch Tee MBT

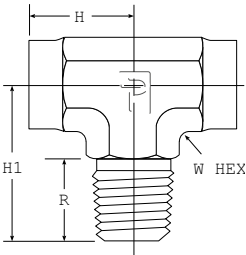
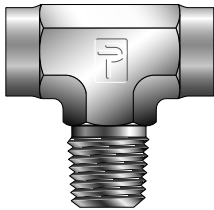

Parker Part No.	NPT Thread		W Hex	H (in.)	H ₁ (in.)	R (in.)	Working Pressures (PSIG)		
	Male	Female					Brass	Stainless Steel	Steel
1-1-1 MBT	1/16	1/16	7/16	.50	.72	.38	3800	7000	7500
2-2-2 MBT	1/8	1/8	9/16	.66	.78	.38	2900	5500	5900
4-4-4 MBT	1/4	1/4	3/4	.88	1.09	.56	3000	5600	6000
6-6-6 MBT	3/8	3/8	7/8	1.02	1.22	.56	2700	5000	5300
8-8-8 MBT	1/2	1/2	1-1/16	1.23	1.47	.75	2500	4500	4800
12-12-12 MBT	3/4	3/4	1-5/16	1.36	1.59	.75	2000	3500	3700
16-16-16 MBT	1	1	1-5/8	1.63	1.97	.94	2300	3900	4200

Female Cross FX

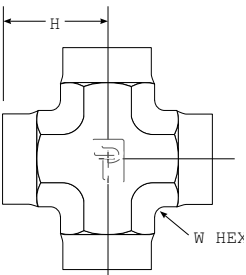
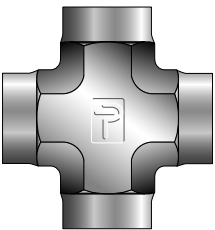

Parker Part No.	NPT Thread Female	W Hex	H (in.)	Working Pressures (PSIG)		
				Brass	Stainless Steel	Steel
1 FX	1/16	7/16	.50	3800	7000	7500
2 FX	1/8	9/16	.66	2900	5500	5900
4 FX	1/4	3/4	.88	3000	5600	6000
6 FX	3/8	7/8	1.06	2700	5000	5300
8 FX	1/2	1-1/16	1.23	2500	4500	4800
12 FX	3/4	1-5/16	1.36	2000	3500	3700
16 FX	1	1-5/8	1.63	2300	3900	4200

Dimensions for reference only, subject to change.

Instrument Pipe Fittings

Pipe Cap CP

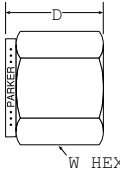

Parker Part No.	NPT Thread Female	W Hex	D (in.)	Working Pressures (PSIG)		
				Brass	Stainless Steel	Steel
1 CP	1/16	7/16	.50	4500	7500	8000
2 CP	1/8	9/16	.75	4000	6400	6800
4 CP	1/4	3/4	.91	4300	6600	7000
6 CP	3/8	7/8	1.03	3500	5300	5600
8 CP	1/2	1-1/16	1.34	3600	5200	5500
12 CP	3/4	1-1/4	1.44	3000	4300	4600
16 CP	1	1-5/8	1.63	3100	4500	4800

Hex Head Plug PH

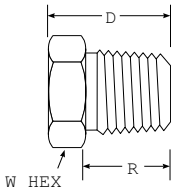
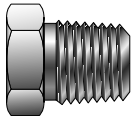

Parker Part No.	NPT Thread Male	W Hex	D (in.)	R (in.)	Working Pressures (PSIG)		
					Brass	Stainless Steel	Steel
1 PH	1/16	3/8	.54	.38	6000	10500	10000
2 PH	1/8	7/16	.56	.38	5600	9700	9100
4 PH	1/4	9/16	.75	.56	4100	8000	7500
6 PH	3/8	11/16	.78	.56	4000	7600	7200
8 PH	1/2	7/8	.97	.75	3900	7000	6600
12 PH	3/4	1-1/16	1.06	.75	3800	6800	6400
16 PH	1	1-5/16	1.25	.94	2700	4900	4600

Hollow Hex Plug PHH

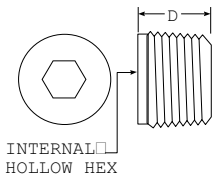
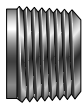

Parker Part No.	NPT Thread Male	W Internal Hex	D (in.)	Working Pressures (PSIG)		
				Brass	Stainless Steel	Steel
1 PHH	1/16	5/32	.30	6000	10000	10500
2 PHH	1/8	3/16	.30	5600	9100	9700
4 PHH	1/4	1/4	.47	4100	7500	8000
6 PHH	3/8	5/16	.47	4000	7200	7600

Dimensions for reference only, subject to change.

Instrument Pipe Fittings

Hex Head Plug P50N

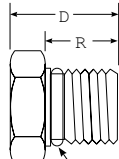
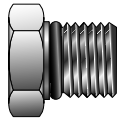

W HEX "O" RIN

Parker Part No.	Interchanges With	Port Thd UN/UNF-2A	W Hex	D (in.)	R (in.)	*D ₂ Drill (in.)	*L ₂ (in.)	O-Ring
4 P50N	4 PST	7/16-20	9/16	0.67	0.36	0.203	0.41	3-904
6 P50N	6 PST	9/16-18	11/16	0.73	0.39	0.297	0.44	3-906
8 P50N	8 PST	3/4-16	7/8	0.80	0.44	0.422	0.44	3-908
12 P50N	12 PST	1-1/16-12	1-1/4	1.09	0.59	0.656	0.59	3-912
16 P50N	16 PST	1-5/16-12	1-1/2	1.13	0.59	0.875	0.50	3-916

*D2 drill and L2 depth are optional manufacturing method per SAE.

Hollow Hex Plug HP50N

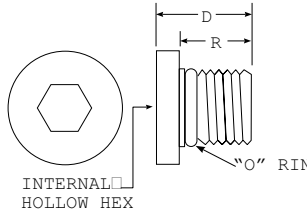
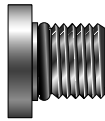

Parker Part No.	Interchanges With	Port Thd UN/UNF-2A	Internal Hex	R (in.)	D (in.)	X Dia. (in.)	O-Ring
4 HP50N	4 HPST	7/16-20	3/16	0.36	0.47	0.56	3-904
6 HP50N	6 HPST	9/16-18	1/4	0.39	0.50	0.69	3-906
8 HP50N	8 HPST	3/4-16	5/16	0.44	0.58	0.88	3-908
12 HP50N	12 HPST	1-1/16-12	9/16	0.59	0.77	1.25	3-912
16 HP50N	16 HPST	1-5/16-12	5/8	0.59	0.77	1.50	3-916

Straight Thread Reducer/Expander F50G5

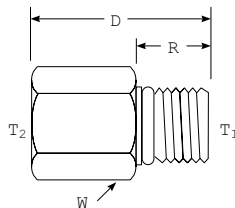
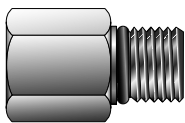

Parker Part No.	Interchanges With	T ₂ Port THD UN/UNF-2B	T ₁ Port THD UN/UNF-2A	W Hex	*D ₂ Drill (in.)	D (in.)	R (in.)	O-Ring
6-4 F50G5	6-RBST-4	7/16-20	9/16-18	11/16	.297	1.03	.36	3-904
8-4 F50G5	8-RBST-4	7/16-20	3/4-16	7/8	.375	1.09	.36	3-904
12-8 F50G5	12-RBST-8	3/4-16	1-1/16-12	1-1/4	.625	1.00	.44	3-908
16-12 F50G5	16-RBST-12	1-1/16-12	1-5/16-12	1-1/2	.750	1.75	.59	3-912

*D2 drill is optional manufacturing method per SAE.

Dimensions for reference only, subject to change.

Instrument Pipe Fittings

Male SAE Straight Thread to Female NPT Thread GOA

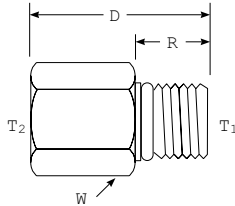
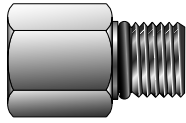

Parker Part No.	Interchanges With	T ₁ Straight Thread Size	T ₂ - NPT Female Pipe Size	D (in.)	R (in.)	E Minimum Opening (in.)	W Hex	ST O-Ring Uniform Size #
4-4 GOA	4SAE-7-4	7/16-20	1/4	1.19	.36	.20	3/4	3-904
6-6 GOA	6SAE-7-6	9/16-18	3/8	1.26	.39	.30	7/8	3-906
8-8 GOA	8-8 SAE-7-8	3/4-16	1/2	1.50	.44	.39	1-1/8	3-908
12-12 GOA	12-12 SAE-7-12	1-1/16-12	3/4	1.83	.59	.66	1-1/4	3-912
16-16 GOA	16-16 SAE-7-16	1-5/16-12	1	1.88	.59	.88	1-5/8	3-916

Includes O-ring.

Male Connector to SAE Straight Thread

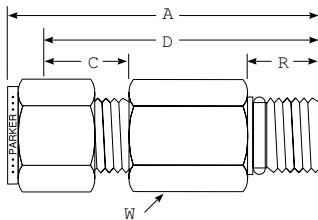
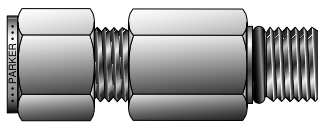

Parker CPI™ Part No.	Parker A-LOK® Part No.	Interchanges With	Tube O.D.	Straight Thread Size	W Hex	A† (in.)	C† (in.)	D (in.)	R (in.)	O-Ring Dash No.
4-4 ZH3BA	4-4 ZH3LA	400-IL-4ST	1/4	7/16-20	9/16	2.26	.70	1.97	.36	3-904
5-5 ZH3BA	5-5 ZH3LA	500-IL-5ST	5/16	1/2-20	5/8	2.32	.73	2.03	.36	3-905
6-6 ZH3BA	6-6 ZH3LA	600-IL-6ST	3/8	9/16-18	11/16	2.48	.76	2.19	.39	3-906
8-8 ZH3BA	8-8 ZH3LA	810-IL-8ST	1/2	3/4-16	7/8	2.99	.87	2.58	.44	3-908
10-10 ZH3BA	10-10 ZH3LA	1010-IL-10ST	5/8	7/8-14	1	3.34	.87	2.94	.50	3-910
12-12 ZH3BA	12-12 ZH3LA	1210-IL-12ST	3/4	1-1/16-12	1-1/4	3.88	.87	3.48	.59	3-912
14-14 ZH3BA	14-14 ZH3LA	1410-IL-14ST	7/8	1-3/16-12	1-3/8	4.07	.87	3.67	.59	3-914
16-16 ZH3BA	16-16 ZH3LA	1610-IL-16ST	1	1-5/16-12	1-1/2	4.35	1.05	3.86	.59	3-916

Includes body, nut, ferrule and O-ring.
†Average value.

O-Ring Seals

All standard O-Rings are Nitrile material, 70 Durometer hardness.
For other materials state material after part number.

Dimensions for reference only, subject to change.

ISO Conversion Fittings

Visual Index

ISO Fitting Nomenclature
page 122

Typical Fastening Threads
page 123

BSPP Thread Forms
page 124

ISO Conversion Fittings

**NPT Male/
BSP Taper Male**
page 125

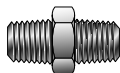

**NPT Male/
BSPP Male**
page 125

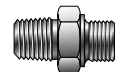

**NPT Female/
BSP Taper Male**
page 125

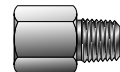

**NPT Female/
BSPP Male**
page 126



**BSP Taper Female/
NPT Male**
page 126

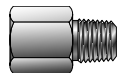

**BSPP Female/
NPT Male**
page 126

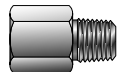

**BSP Taper Male
Hex Pipe Plug**
page 127



**BSPP Parallel
Male Hex
Pipe Plug**
page 127



ISO Thread/ Fractional Tube Connectors

**BSP Taper Male
Connector**
page 128



**BSPP Male
Connector**
page 128



**BSP Taper Female
Connector**
page 129



**BSPP Female
Gauge
Connector**
page 129



**BSP Taper
Male Elbow**
page 129

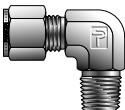

**BSPP Male
Elbow
(Positionable)**
page 130

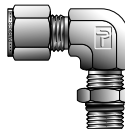

**BSPP Male Run Tee
(Positionable)**
page 130

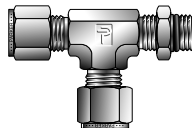

**BSPP Male Branch Tee
(Positionable)**
page 131

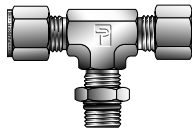

**BSP Taper
Male Adapter**
page 131

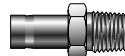

**BSPP Male
Adapter**
page 132



**BSP Taper Female
Adapter**
page 132

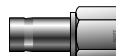

**BSPP Female
Adapter**
page 132

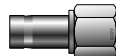

**BSPP Female
Gauge Adapter**
page 133



Sealing Washers

**Bonded Seals
(Stainless)**
page 133



**Copper Washers/
Male**
page 133



**Copper Washers/
Female**
page 133



ISO Conversion Fittings

Parker ISO Fitting Nomenclature

Parker ISO Adapters utilize the same basic part numbering system that you are already familiar with from our CPI™ and A-LOK® Catalogs. To specify a Parker Instrumentation Connector with an ISO thread form, simply suffix the **size designator** with the **thread form designator** as illustrated.

Build a **CPI™** or **Pipe** part number by filling in the following boxes:



Build an **A-LOK®** part number by filling in the following boxes:

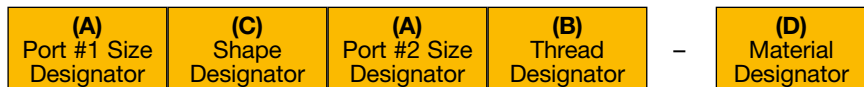

(A) Port Size Designators:

Port sizes are incremented by 1/16" and only the numerator is required to specify a size in a part number.

1 = 1/16"	6 = 3/8"
2 = 1/8"	8 = 1/2"
3 = 3/16"	10 = 5/8"
4 = 1/4"	12 = 3/4"
5 = 5/16"	16 = 1" (larger sizes available)

(B) Thread Type Designators:

Leave **Blank**: Fractional Tube Size

N* = NPT per ANSI B1.20.1

K = ISO Taper per; ISO 7/1, BS21, JIS B0203, DIN 2999

R = ISO Parallel per; ISO 228/1+2, DIN 3852 Form A, BS2779 (BSPP), JIS B0202

BR = ISO Parallel per; ISO 228/1+2, DIN 3852 Form B, BS2779 (BSPP), JIS B0202

GC = ISO Parallel, Female Gauge connector

* N thread type designator is only required for A-LOK® nomenclature

(C) Body Shape Designator:

FBZ = CPI™ Male Connector

MSC = A-LOK® Male Connector

RA = Pipe Reducing Adapter

MHN = Pipe Male Hex Nipple

See Catalog for further detail

(D) Material Designators:*

SS = Stainless Steel for CPI™ and Pipe Fittings

316 = Stainless Steel for A-LOK®

B = Brass

*Other materials available - please contact the factory

Material	Standard
Stainless Steel	ASTM A276 ASME SA 479
Brass	ASTM B16 ASTM B 453

Sealing

BSP Taper threads require the use of a thread sealant. **BSPP threads** require a sealing washer. This washer may either be a metal gasket (copper is standard) or a "bonded seal" (elastomer bonded to a metal retaining washer). The **BSPP**, form "**A**" requires the use of a bonded seal (page 133). The BSPP, form "**B**" (cutting face) may be used with or without a sealing washer. For applications where the cutting face may not seal or where galling is a potential problem, the use of a washer is suggested.

Examples: The Thread Type Designators have been highlighted in the following examples for easy recognition:

4-4**K** FBZ-SS 1/4" CPI™ tube fitting by 1/4" BSPT pipe thread

6-4**R** RA-SS 3/8" female NPT by 1/4" BSPP (form A) reducing adapter
A bonded seal should be used with this fitting (page 133).

6MSC4**BR**-316 3/8" A-LOK® tube fitting by 1/4" BSPP (form B)
A copper washer should be used with this fitting (page 133).

ISO Conversion Fittings

Typical Fastening Threads

BSP threads

BSPP Parallel and BSP Taper threads have a thread flank angle of 55° inclusive.

BSPP – British Standard Pipe Parallel threads for tubes and fittings where pressure-tight joints are not made on the thread, i.e., a peripheral seal is used.

BSP Taper – British Standard Pipe Taper threads for tubes and fittings where pressure-tight joints are made on the threads.

Comparison of Thread Forms

NPT Thread Size	Threads per Inch	BSPP	BSPT	Threads per Inch
		Thread Size		
1/8	27	1/8	1/8	28
1/4	18	1/4	1/4	19
3/8	18	3/8	3/8	19
1/2	14	1/2	1/2	14
3/4	14	3/4	3/4	14
1	11 1/2	1	1	11
1 1/4	11 1/2	1 1/4	1 1/4	11
1 1/2	11 1/2	1 1/2	1 1/2	11

Generic Thread

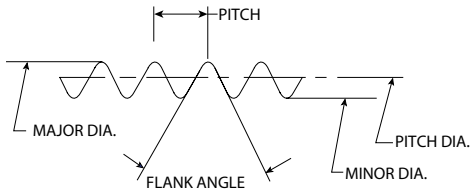

American Standard Pipe Thread (NPT)

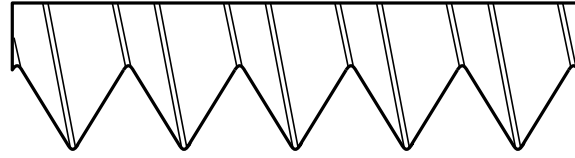

- 60° inclusive thread flank angle
- Pitch measured in inches
- Truncation of root and crest are flat
- Taper angle 1°47'

(ISO 7/1)

BSPT

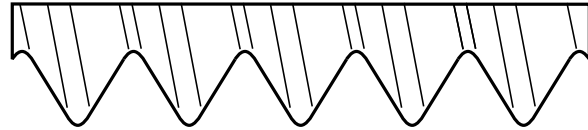

- 55° inclusive thread flank angle
- Pitch measured in inches
- Truncation of root and crest are round
- Taper angle 1°47'

(ISO 228/1)

BSPP

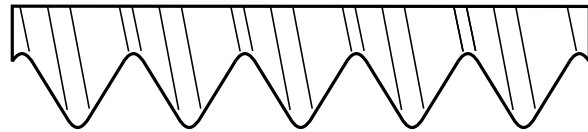

- 55° inclusive thread flank angle
- Pitch measured in inches
- Truncation of root and crest are round
- Diameter measured in inches

ISO Conversion Fittings

BSPP Thread Forms

Form A

A self centering taper is used at the hex which centers a “bonded” washer (usually metal and elastomer) to seal to the surface surrounding the female thread.

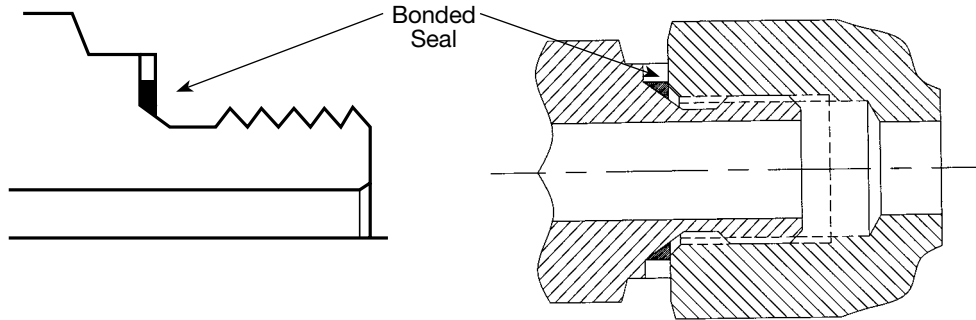

Form B

A metal gasket (usually copper) performs the seal between the face of the body and the face of the female threaded component. For Form “B” replace “R” in part number with “BR”.

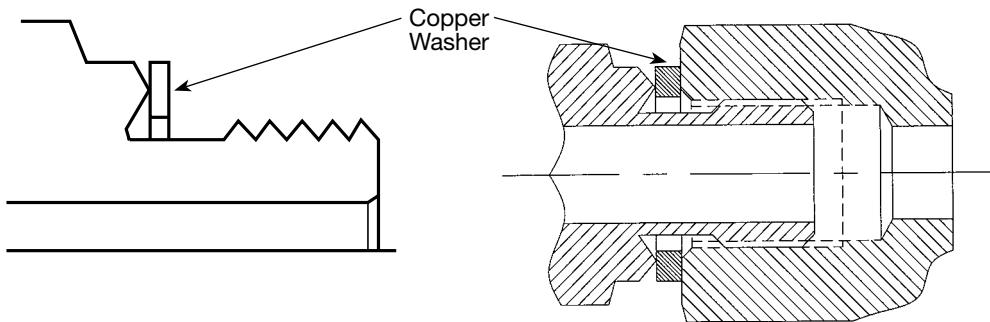

Gauge Port BSPP (Female)

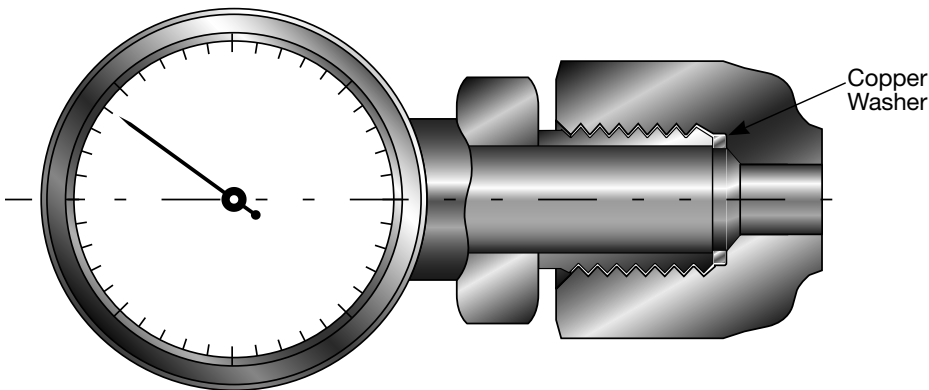

ISO Conversion Fittings

Male Hex Nipple NPT to BSP Taper

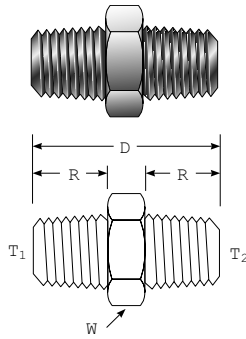

Parker Part No.	NPT Thread T ₁	BSPT Thread T ₂	W Hex	D (in.)	R (in.)	Working Pressure			
						Brass		Stainless Steel	
						PSI	Bar	PSI	Bar
2-2K MHN	1/8-27	1/8-28	7/16	1.06	.38	5600	390	9100	630
4-4K MHN	1/4-18	1/4-19	5/8	1.45	.56	4100	280	7500	520
6-6K MHN	3/8-18	3/8-19	3/4	1.45	.56	4000	280	7200	500
8-8K MHN	1/2-14	1/2-14	7/8	1.89	.75	3900	270	6600	460
12-12K MHN	3/4-14	3/4-14	1 1/8	1.97	.75	3800	260	6400	440
16-16K MHN	1-11 1/2	1-11	1 3/8	2.34	.94	2700	190	4600	320

Used to connect a female NPT and a female BSPT threaded component.

Male Hex Nipple NPT to BSPP

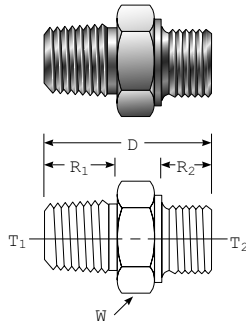

Parker Part No.	NPT Thread T ₁	BSPP Thread T ₂	W Hex	D (in.)	R ₁ (in.)	R ₂ (in.)	Working Pressure			
							Brass		Stainless Steel	
							PSI	Bar	PSI	Bar
2-2R MHN	1/8-27	1/8-28	9/16	1.07	.38	.28	5000	340	9100	630
4-4R MHN	1/4-18	1/4-19	3/4	1.44	.56	.44	4000	280	7500	520
6-6R MHN	3/8-18	3/8-19	7/8	1.47	.56	.44	3900	270	7200	500
8-8R MHN	1/2-14	1/2-14	1 1/16	1.78	.75	.56	3800	260	6600	460
12-12R MHN	3/4-14	3/4-14	1 5/16	1.95	.75	.63	3600	250	6400	440
16-16R MHN	1-11 1/2	1-11	1 5/8	2.26	.94	.72	2600	180	4600	320

Used to connect a female NPT and a female BSPP threaded component.

Note: Bonded seal, page 133, must be used on BSPP end shown.

Please note the pressure ratings are based on taper threaded ends. The pressure rating for the BSPP ends are dependent on the type of sealing washer used.

Female NPT to Male BSP Taper Adapter

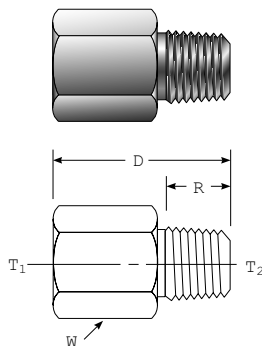

Parker Part No.	NPT Thread T ₁	BSPT Thread T ₂	W Hex	D (in.)	R (in.)	Working Pressure			
						Brass		Stainless Steel	
						PSI	Bar	PSI	Bar
2-2K RA	1/8-27	1/8-28	9/16	1.09	.38	3200	220	6100	420
4-4K RA	1/4-18	1/4-19	3/4	1.42	.56	3300	230	6200	430
6-6K RA	3/8-18	3/8-19	7/8	1.49	.56	2600	180	5000	340
8-8K RA	1/2-14	1/2-14	1 1/16	1.94	.75	2400	160	4600	320
12-12K RA	3/4-14	3/4-14	1 5/16	2.00	.75	2300	160	4300	300
16-16K RA	1-11 1/2	1-11	1 5/8	2.28	.94	2200	150	4100	280

Used to connect a male NPT and a female BSPT threaded component.

Dimensions for reference only, subject to change.

ISO Conversion Fittings

Female NPT to Male BSPP Adapter

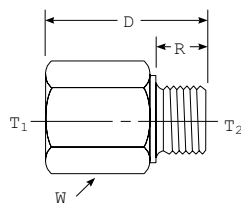
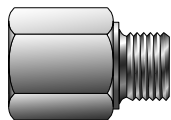

Parker Part No.	NPT Thread T ₁	BSPP Thread T ₂	W Hex	D (in.)	R (in.)	Working Pressure			
						Brass		Stainless Steel	
						PSI	Bar	PSI	Bar
2-2R RA	1/8-27	1/8-28	9/16	.99	.28	3200	220	6100	420
4-4R RA	1/4-18	1/4-19	3/4	1.31	.44	3300	230	6200	430
6-6R RA	3/8-18	3/8-19	7/8	1.41	.44	2600	180	5000	340
8-8R RA	1/2-14	1/2-14	1 1/8	1.74	.56	2400	160	4600	320
12-12R RA	3/4-14	3/4-14	1 5/16	2.00	.63	2300	160	4300	300
16-16R RA	1-11 1/2	1-11	1 5/8	2.10	.72	2200	150	4100	280

Used to connect a male NPT and a female BSPP threaded component.
Note: Bonded Seal, page 133, must be used with BSPP end shown.

Female BSP Taper to Male NPT Adapter

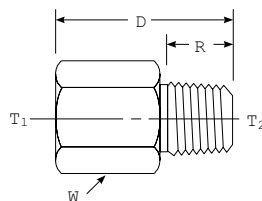
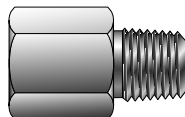

Parker Part No.	BSPT Thread T ₁	NPT Thread T ₂	W Hex	D (in.)	R (in.)	Working Pressure			
						Brass		Stainless Steel	
						PSI	Bar	PSI	Bar
2K-2 RA	1/8-28	1/8-27	9/16	1.09	.38	3200	220	6100	420
4K-4 RA	1/4-19	1/4-18	3/4	1.42	.56	3300	230	6200	430
6K-6 RA	3/8-19	3/8-18	7/8	1.49	.56	2600	180	5000	340
8K-8 RA	1/2-14	1/2-14	1 1/8	1.94	.75	2400	160	4600	320
12K-12 RA	3/4-14	3/4-14	1 5/16	2.00	.75	2300	160	4300	300
16K-16 RA	1-11	1-11 1/2	1 5/8	2.28	.94	2200	150	4100	280

Used to connect a male BSPT and a female NPT threaded component.

Female BSPP to Male NPT Adapter

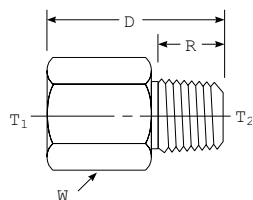
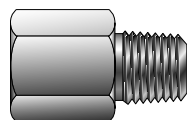

Parker Part No.	BSPP Thread T ₁	NPT Thread T ₂	W Hex	D (in.)	R (in.)	Working Pressure			
						Brass		Stainless Steel	
						PSI	Bar	PSI	Bar
2R-2 RA	1/8-28	1/8-27	9/16	1.09	.38	3200	220	6100	420
4R-4 RA	1/4-19	1/4-18	3/4	1.50	.56	3300	230	6200	430
6R-6 RA	3/8-19	3/8-18	7/8	1.49	.56	2600	180	5000	340
8R-8 RA	1/2-14	1/2-14	1 1/8	1.88	.75	2400	160	4600	320
12R-12 RA	3/4-14	3/4-14	1 5/16	2.00	.75	2300	160	4300	300
16R-16 RA	1-11	1-11 1/2	1 5/8	2.28	.94	2200	150	4100	280

Used to connect a male BSPP and a female NPT threaded component.

ISO Conversion Fittings

BSP Taper Male Hex Pipe Plug

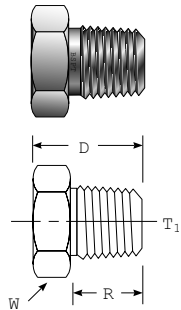

Parker Part No.	BSPT Thread T ₁	W Hex	D (in.)	R (in.)	Working Pressure			
					Brass		Stainless Steel	
					PSI	Bar	PSI	Bar
2K PH	1/8-28	7/16	.59	.38	3200	220	6100	420
4K PH	1/4-19	5/8	.81	.56	3300	230	6200	430
6K PH	3/8-19	3/4	.81	.56	2600	180	5000	340
8K PH	1/2-14	7/8	1.06	.75	2400	160	3600	320
12K PH	3/4-14	1 1/8	1.13	.75	2300	160	4300	300
16K PH	1-11	1 3/8	1.31	.94	2200	150	4100	280

BSPP Parallel Male Hex Pipe Plug

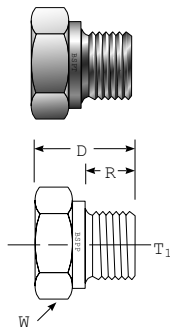

Parker Part No.	BSPT Thread T ₁	W Hex	D (in.)	R (in.)	Working Pressure			
					Brass		Stainless Steel	
					PSI	Bar	PSI	Bar
2R PH	1/8-28	9/16	.55	.28	5000	340	9100	630
4R PH	1/4-19	3/4	.78	.44	4000	280	7500	520
6R PH	3/8-19	7/8	.78	.44	3900	270	7200	500
8R PH	1/2-14	1-1/16	.99	.56	3800	260	6600	460
12R PH	3/4-14	1-5/16	1.13	.63	3600	250	6400	440
16R PH	1-11	1-5/8	1.21	.72	2600	180	4600	320

Note: Bonded seal page 133 must be used on BSPP end shown.
Please note the pressure ratings are based on taper threaded ends. The pressure rating for the BSPP ends are dependent on the type of sealing washer used.

Dimensions for reference only, subject to change.

ISO Conversion Fittings

BSP Taper Male Connector

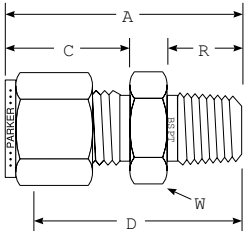
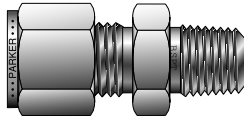

Tube O.D. (in.)	BSP Thread	Parker CPI™ Part No.	Parker A-LOK® Part No.	A (in.)	C (in.)	D (in.)	R (in.)	W Hex
1/8	1/8-28	2-2K FBZ	2MSC2K	1.20	.60	.94	.38	7/16
1/8	1/4-19	2-4K FBZ	2MSC4K	1.40	.60	1.14	.56	9/16
1/4	1/8-28	4-2K FBZ	4MSC2K	1.30	.70	1.00	.38	1/2
1/4	1/4-19	4-4K FBZ	4MSC4K	1.50	.70	1.20	.56	9/16
1/4	3/8-19	4-6K FBZ	4MSC6K	1.52	.70	1.22	.56	11/16
1/4	1/2-14	4-8K FBZ	4MSC8K	1.76	.70	1.44	.75	7/8
5/16	1/8-28	5-2K FBZ	5MSC2K	1.34	.73	1.05	.38	9/16
5/16	1/4-19	5-4K FBZ	5MSC4K	1.53	.73	1.23	.56	9/16
3/8	1/8-28	6-2K FBZ	6MSC2K	1.39	.76	1.09	.38	5/8
3/8	1/4-19	6-4K FBZ	6MSC4K	1.59	.76	1.28	.56	5/8
3/8	3/8-19	6-6K FBZ	6MSC6K	1.59	.76	1.28	.56	11/16
3/8	1/2-14	6-8K FBZ	6MSC8K	1.82	.76	1.53	.75	7/8
1/2	1/4-19	8-4K FBZ	8MSC4K	1.75	.87	1.31	.56	13/16
1/2	3/8-19	8-6K FBZ	8MSC6K	1.75	.87	1.31	.56	13/16
1/2	1/2-14	8-8K FBZ	8MSC8K	1.93	.87	1.53	.75	7/8

Connects fractional tube to female ISO taper thread.

BSPP Male Connector

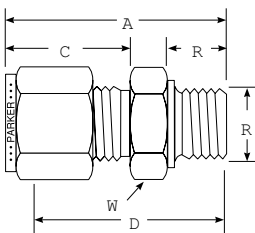
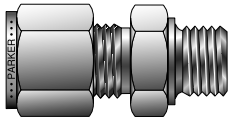

Tube O.D. (in.)	BSP Thread	Parker CPI™ Part No.	Parker A-LOK® Part No.	A (in.)	C (in.)	D (in.)	R (in.)	W Hex
1/8	1/8-28	2-2R FBZ	2MSC2R	1.18	.60	0.92	.28	9/16
1/8	1/4-19	2-4R FBZ	2MSC4R	1.38	.60	1.13	.44	3/4
1/8	3/8-19	2-6R FBZ	2MSC6R	1.43	.60	1.17	.44	7/8
1/4	1/8-28	4-2R FBZ	4MSC2R	1.28	.70	0.98	.28	9/16
1/4	1/4-19	4-4R FBZ	4MSC4R	1.49	.70	1.19	.44	3/4
1/4	3/8-19	4-6R FBZ	4MSC6R	1.55	.70	1.25	.44	7/8
1/4	1/2-14	4-8R FBZ	4MSC8R	1.77	.70	1.47	.56	1 1/16
3/8	1/8-28	6-2R FBZ	6MSC2R	1.37	.76	1.06	.28	5/8
3/8	1/4-19	6-4R FBZ	6MSC4R	1.57	.76	1.25	.44	3/4
3/8	3/8-19	6-6R FBZ	6MSC6R	1.59	.76	1.30	.44	7/8
3/8	1/2-14	6-8R FBZ	6MSC8R	1.84	.76	1.53	.56	1 1/16
1/2	1/4-19	8-4R FBZ	8MSC4R	1.71	.87	1.28	.44	13/16
1/2	3/8-19	8-6R FBZ	8MSC6R	1.74	.87	1.30	.44	7/8
1/2	1/2-14	8-8R FBZ	8MSC8R	1.96	.87	1.53	.56	1 1/16
3/4	1/2-14	12-8R FBZ	12MSC8R	1.93	.87	1.53	.56	1 1/16
3/4	3/4-19	12-12R FBZ	12MSC12R	2.10	.87	1.69	.63	1 3/8
1	1/2-14	16-8R FBZ	16MSC8R	2.21	1.05	1.72	.56	1 3/8
1	1-11	16-16R FBZ	16MSC16R	2.37	1.05	1.88	.72	1 5/8

Connects fractional tube to female ISO parallel thread.

Note: Bonded Seal, page 133, must be used with BSPP end shown.

Dimensions for reference only, subject to change.

ISO Conversion Fittings

BSP Taper Female Connector

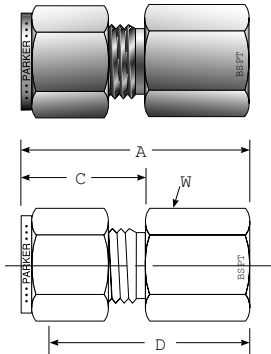

Tube O.D. (in.)	BSPT Thread	Parker CPI™ Part No.	Parker A-LOK® Part No.	A (in.)	C (in.)	D (in.)	W Hex
1/4	1/8-28	4-2K GBZ	4FSC2K	1.23	.70	.94	9/16
1/4	1/4-19	4-4K GBZ	4FSC4K	1.42	.70	1.13	3/4
1/4	3/8-19	4-6K GBZ	4FSC6K	1.48	.70	1.19	7/8
1/4	1/2-14	4-8K GBZ	4FSC8K	1.67	.70	1.38	1 1/16
3/8	1/4-19	6-4K GBZ	6FSC4K	1.48	.76	1.19	3/4
3/8	3/8-19	6-6K GBZ	6FSC6K	1.54	.76	1.25	7/8
3/8	1/2-14	6-8K GBZ	6FSC8K	1.73	.76	1.44	1 1/16
1/2	1/4-19	8-4K GBZ	8FSC4K	1.59	.87	1.19	13/16
1/2	3/8-19	8-6K GBZ	8FSC6K	1.65	.87	1.25	7/8
1/2	1/2-14	8-8K GBZ	8FSC8K	1.84	.87	1.44	1 1/16

Connects fractional tube to male ISO taper thread.

BSPP Female Gauge Connector

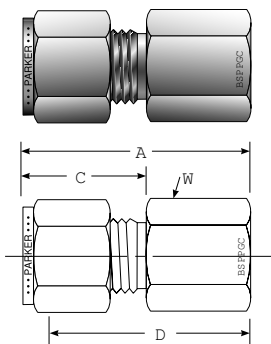

Tube O.D. (in.)	BSPP Thread	Parker CPI™ Part No.	Parker A-LOK® Part No.	A (in.)	C (in.)	D (in.)	W Hex
1/4	1/4-19	4-4GC GBZ	4FSC4GC	1.48	.70	1.19	3/4
1/4	3/8-19	4-6GC GBZ	4FSC6GC	1.48	.70	1.19	7/8
1/4	1/2-14	4-8GC GBZ	4FSC8GC	1.72	.70	1.42	1 1/16
5/16	1/4-19	5-4GC GBZ	5FSC4GC	1.51	.73	1.22	3/4
5/16	1/2-14	5-8GC GBZ	5FSC8GC	1.61	.73	1.32	1 1/16
3/8	1/4-19	6-4GC GBZ	6FSC4GC	1.54	.76	1.25	3/4
3/8	3/8-19	6-6GC GBZ	6FSC6GC	1.53	.76	1.23	7/8
3/8	1/2-14	6-8GC GBZ	6FSC8GC	1.65	.76	1.36	1 1/16
1/2	3/8-19	8-6GC GBZ	8FSC6GC	1.75	.87	1.35	7/8
1/2	1/2-14	8-8GC GBZ	8FSC8GC	1.90	.87	1.50	1 1/16

Connects fractional tube to male ISO parallel (gauge).

Note: Copper Washer, page 133, for female thread sealing, must be used on BSPP female end shown.

BSP Taper Male Elbow

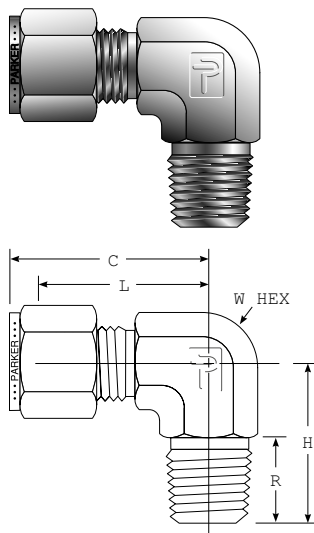

Tube O.D. (in.)	BSPT Thread	Parker CPI™ Part No.	Parker A-LOK® Part No.	C (in.)	H (in.)	L (in.)	R (in.)	W Hex
1/4	1/8-28	4-2K CBZ	4MSEL2K	1.06	.74	.77	.38	1/2
1/4	1/4-19	4-4K CBZ	4MSEL4K	1.08	1.00	.78	.56	9/16
1/4	3/8-19	4-6K CBZ	4MSEL6K	1.17	1.13	.88	.56	3/4
1/4	1/2-14	4-8K CBZ	4MSEL8K	1.26	1.31	.97	.75	7/8
5/16	1/4-19	5-4K CBZ	5MSEL4K	1.11	1.00	.81	.56	5/8
3/8	1/8-28	6-2K CBZ	6MSEL2K	1.20	.82	.91	.38	5/8
3/8	1/4-19	6-4K CBZ	6MSEL4K	1.20	1.01	.91	.56	5/8
3/8	3/8-19	6-6K CBZ	6MSEL6K	1.26	1.13	.97	.56	3/4
1/2	3/8-19	8-6K CBZ	8MSEL6K	1.42	1.15	1.02	.56	13/16
1/2	1/2-14	8-8K CBZ	8MSEL8K	1.42	1.30	1.02	.75	7/8

Connects fractional tube to female ISO taper thread.

Dimensions for reference only, subject to change.

ISO Conversion Fittings

BSPB Male Elbow (Positionable)

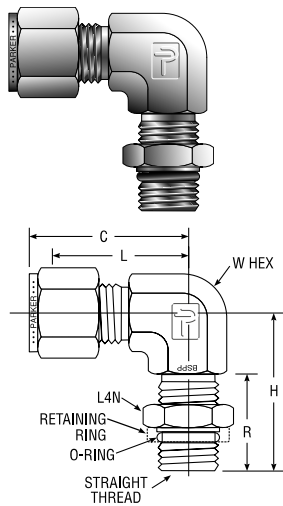

Tube O.D. (in.)	BSPB Thread	Parker CPI™ Part No.	Parker A-LOK® Part No.	C (in.)	H (in.)	L (in.)	R (in.)	W Hex
1/4	1/8-28	4-2R CBZ	4MSEL2R	1.06	1.04	.77	.63	9/16
1/4	1/4-19	4-4R CBZ	4MSEL4R	1.14	1.27	.85	.79	9/16
3/8	1/4-19	6-4R CBZ	6MSEL4R	1.14	1.27	.85	.79	9/16
3/8	3/8-19	6-6R CBZ	6MSEL6R	1.50	1.46	1.02	.79	3/4
1/2	1/4-19	8-4R CBZ	8MSEL4R	1.50	1.38	1.10	.79	7/8
1/2	3/8-19	8-6R CBZ	8MSEL6R	1.50	1.46	1.10	.79	7/8
1/2	1/2-14	8-8R CBZ	8MSEL8R	1.50	1.71	1.10	1.03	7/8
5/8	1/2-14	10-8R CBZ	10MSEL8R	1.50	1.81	1.10	1.03	1 1/16
3/4	1/2-14	12-8R CBZ	12MSEL8R	1.57	1.81	1.17	1.03	1 1/16
3/4	3/4-14	12-12R CBZ	12MSEL12R	1.57	1.92	1.17	1.03	1 1/16
1	3/4-14	16-12R CBZ	16MSEL12R	1.94	2.11	1.45	1.03	1 5/16
1	1-11	16-16R CBZ	16MSEL16R	1.94	2.11	1.45	1.20	1 5/16

Connects fractional tube to female ISO parallel thread.

BSPB Male Run Tee (Positionable)

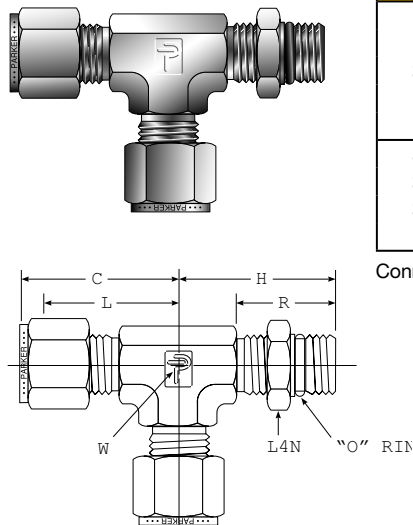

Tube O.D. (in.)	BSPB Thread	Parker CPI™ Part No.	Parker A-LOK® Part No.	C (in.)	H (in.)	L (in.)	R (in.)	W Hex
1/4	1/8-28	4-2R-4 RBZ	4MRT2R	1.06	1.04	.77	.63	9/16
1/4	1/4-19	4-4R-4 RBZ	4MRT4R	1.14	1.27	.85	.79	9/16
3/8	1/4-19	6-4R-6 RBZ	6MRT6R	1.20	1.27	.91	.79	9/16
1/2	3/8-19	8-6R-8 RBZ	8MRT8R	1.50	1.46	1.10	.79	7/8
1/2	1/2-14	8-8R-8 RBZ	8MRT8R	1.50	1.71	1.10	1.03	7/8
5/8	1/2-14	10-8R-10 RBZ	10MRT8R	1.50	1.81	1.10	1.03	1 1/16
3/4	1/2-14	12-8R-12 RBZ	12MRT8R	1.57	1.81	1.17	1.03	1 1/16
3/4	3/4-14	12-12R-12 RBZ	12MRT12R	1.57	1.92	1.17	1.03	1 1/16
1	1-11	16-16R-16 RBZ	16MRT16R	1.94	2.11	1.45	1.20	1 5/16

Connects fractional tube to female ISO parallel thread.

Dimensions for reference only, subject to change.

ISO Conversion Fittings

BSP Male Branch Tee (Positionable)

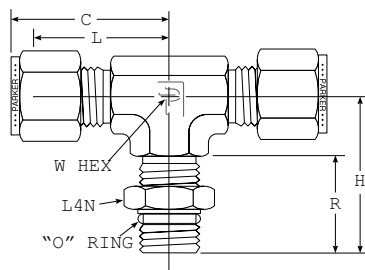
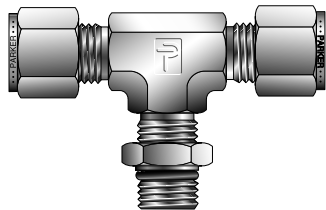

Tube O.D. (in.)	BSP Thread	Parker CPI™ Part No.	Parker A-LOK® Part No.	C (in.)	H (in.)	L (in.)	R (in.)	W Hex
1/4	1/8-28	4-4-2R SBZ	4MBT2R	1.06	1.04	.77	.63	9/16
1/4	1/4-19	4-4-4R SBZ	4MBT4R	1.14	1.27	.85	.79	9/16
3/8	1/4-19	6-6-4R SBZ	6MBT4R	1.14	1.27	.85	.79	9/16
1/2	3/8-19	8-8-6R SBZ	8MBT6R	1.50	1.46	1.10	.79	7/8
1/2	1/2-14	8-8-8R SBZ	8MBT8R	1.50	1.71	1.10	1.03	7/8
5/8	1/2-14	10-10-8R SBZ	10MBT8R	1.50	1.81	1.10	1.03	1 1/16
3/4	1/2-14	12-12-8R SBZ	12MBT8R	1.57	1.81	1.17	1.03	1 1/16
3/4	3/4-14	12-12-12R SBZ	12MBT12R	1.57	1.92	1.17	1.03	1 1/16
1	1-11	16-16-16R SBZ	16MBT16R	1.94	2.11	1.45	1.20	1 5/16

Connects fractional tube to female ISO parallel thread.

BSP Taper Male Adapter

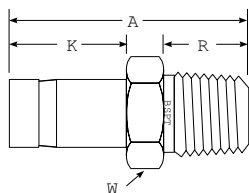
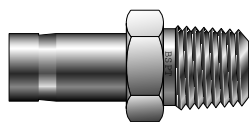

Tube O.D. (in.)	BSPT Thread	Parker CPI™ Part No.	Parker A-LOK® Part No.	CPI™		A-LOK®		R (in.)	W Hex	Min. Bore (in.)
				A (in.)	K (in.)	A (in.)	K (in.)			
1/8	1/8-28	2-2K T2HF	2MA2K	1.16	0.54	1.16	.54	.38	7/16	.078
1/8	1/4-19	2-4K T2HF	2MA4K	1.39	0.54	1.39	.54	.56	9/16	.281
1/4	1/8-28	4-2K T2HF	4MA2K	1.27	0.64	1.25	.63	.38	7/16	.156
1/4	1/4-19	4-4K T2HF	4MA4K	1.49	0.64	1.46	.63	.56	9/16	.078
5/16	1/8-28	5-2K T2HF	5MA2K	1.32	0.68	1.28	.66	.38	7/16	.219
5/16	1/4-19	5-4K T2HF	5MA4K	1.53	0.68	1.49	.66	.56	9/16	.219
3/8	1/4-19	6-4K T2HF	6MA4K	1.57	0.72	1.53	.69	.56	9/16	.281
3/8	3/8-19	6-6K T2HF	6MA6K	1.61	0.72	1.56	.69	.56	11/16	.281
3/8	1/2-14	6-8K T2HF	6MA8K	1.82	0.72	1.78	.69	.75	7/8	.281
1/2	1/4-19	8-4K T2HF	8MA4K	1.84	0.98	1.75	.91	.75	9/16	.281
1/2	3/8-19	8-6K T2HF	8MA6K	1.87	0.98	1.78	.91	.56	11/16	.375
1/2	1/2-14	8-8K T2HF	8MA8K	2.09	0.98	2.00	.91	.75	7/8	.375
5/8	3/8-19	10-6K T2HF	10MA6K	1.91	1.03	1.84	.97	.56	11/16	.469
5/8	1/2-14	10-8K T2HF	10MA8K	2.14	1.03	2.06	.97	.75	7/8	.469
3/4	3/4-14	12-12K T2HF	12MA12K	2.14	1.03	2.06	.97	.75	1 1/16	.594
1	1-11	16-16K T2HF	16MA16K	2.68	1.30	2.60	1.22	.94	1 3/8	.813

Connects fractional tube to female ISO taper thread.
Generic, annealed tube stub for effective ferrule sealing.

Dimensions for reference only, subject to change.

Instrument Pipe and ISO Conversion Fittings

ISO Conversion Fittings

BSPP Male Adapter

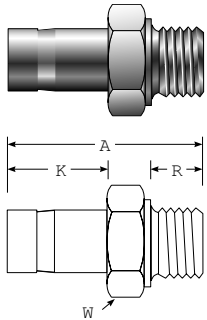

Tube O.D. (in.)	BSPP Thread	Parker CPI™ Part No.	Parker A-LOK® Part No.	CPI™		A-LOK®		R (in.)	W Hex	Min. Bore (in.)h
				A (in.)	K (in.)	A (in.)	K (in.)			
1/8	1/8-28	2-2R T2HF	2MA2R	1.16	.54	1.16	.54	.28	9/16	.078
1/8	1/4-19	2-4R T2HF	2MA4R	1.37	.54	1.37	.54	.44	3/4	.078
1/4	1/8-28	4-2R T2HF	4MA2R	1.26	.64	1.31	.63	.28	9/16	.156
1/4	1/4-19	4-4R T2HF	4MA4R	1.48	.64	1.50	.63	.44	3/4	.156
3/8	1/4-19	6-4R T2HF	6MA4R	1.56	.72	1.57	.69	.44	3/4	.281
3/8	3/8-19	6-6R T2HF	6MA6R	1.59	.72	1.60	.69	.44	7/8	.281
1/2	1/4-19	8-4R T2HF	8MA4R	1.81	.98	1.79	.91	.44	3/4	.375
1/2	3/8-19	8-6R T2HF	8MA6R	1.85	.98	1.82	.91	.44	7/8	.375
1/2	1/2-14	8-8R T2HF	8MA8R	2.10	.98	1.94	.91	.44	1-1/8	.375
3/4	3/4-14	12-12R T2HF	12MA12R	2.22	1.03	2.16	.97	.63	1-3/8	.594
1	1-11	16-16R T2HF	16MA16R	2.67	1.30	2.54	1.22	.72	1-3/4	.813

Connects fractional tube end to female ISO parallel thread.
 Note: Bonded Seal, page 133 must be used on BSPP end shown.
 Generic, annealed tube stub for effective sealing.

BSP Taper Female Adapter

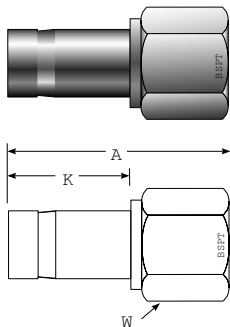

Tube O.D. (in.)	BSPT Thread	Parker CPI™ Part No.	Parker A-LOK® Part No.	CPI™		A-LOK®		W Hex	Min. Bore (in.)
				A (in.)	K (in.)	A (in.)	K (in.)		
1/4	1/8-28	4-2K T2HG	4FA2K	1.31	.64	1.30	.63	9/16	.156
1/4	1/4-19	4-4K T2HG	4FA4K	1.48	.64	1.45	.63	3/4	.156
3/8	1/4-19	6-4K T2HG	6FA4K	1.56	.72	1.50	.69	3/4	.281
3/8	3/8-19	6-6K T2HG	6FA6K	1.63	.72	1.59	.69	7/8	.281
1/2	1/4-19	8-4K T2HG	8FA4K	1.83	.98	1.71	.91	3/4	.375
1/2	3/8-19	8-6K T2HG	8FA6K	1.89	.98	1.80	.91	7/8	.375
1/2	1/2-14	8-8K T2HG	8FA8K	2.14	.98	2.05	.91	1-1/16	.375

Connects fractional tube end to male ISO taper thread.
 Note: Tube stub is pre-grooved as standard. Generic (non-grooved) can be ordered through Quick Response.

BSPP Female Adapter

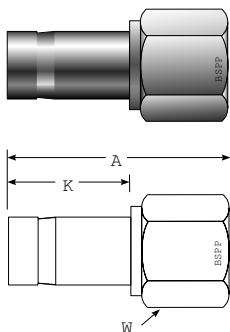

Tube O.D. (in.)	BSPP Thread	Parker CPI™ Part No.	Parker A-LOK® Part No.	CPI™		A-LOK®		W Hex	Min. Bore (in.)
				A (in.)	K (in.)	A (in.)	K (in.)		
1/8	1/8-28	2-2R T2HG	2FA2R	1.21	.54	1.21	.54	9/16	.078
1/4	1/8-28	4-2R T2HG	4FA2R	1.31	.64	1.25	.63	9/16	.156
1/4	1/4-19	4-4R T2HG	4FA4R	1.48	.64	1.50	.63	3/4	.156
3/8	1/4-19	6-4R T2HG	6FA4R	1.56	.72	1.55	.69	3/4	.281
3/8	3/8-19	6-6R T2HG	6FA6R	1.63	.72	1.57	.69	7/8	.281
1/2	3/8-19	8-6R T2HG	8FA6R	1.89	.98	1.78	.91	7/8	.375
1/2	1/2-14	8-8R T2HG	8FA8R	2.14	.98	1.95	.91	1-1/16	.375

Connects fractional tube end to male ISO parallel thread.
 Note: Tube stub is pre-grooved as standard. Generic (non-grooved) can be ordered through Quick Response.

Dimensions for reference only, subject to change.

ISO Conversion Fittings

BSPP Female Gauge Adapter

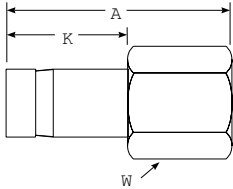
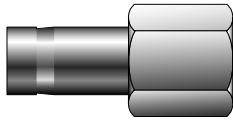

Tube O.D. (in.)	BSPP Thread	Parker CPI™ Part No.	Parker A-LOK® Part No.	CPI™		A-LOK®		W Hex	Min. Bore (in.)
				A (in.)	K (in.)	A (in.)	K (in.)		
1/4	1/4-19	4-4GC T2HG	4FA4GC	1.48	.64	1.34	.63	3/4	.156
3/8	3/8-19	6-6GC T2HG	6FA6GC	1.63	.72	1.55	.69	7/8	.281
1/2	1/2-14	8-8GC T2HG	8FA8GC	2.14	.98	1.92	.91	1 1/16	.375

Connects fractional tube end to male ISO parallel thread (gauge).

Note: Copper Washer, shown below, for female thread sealing, must be used on BSPP female end shown.

Note: Tube stub is pre-grooved as standard. Generic (non-grooved) can be ordered through Quick Response.

Sealing Washers

Bonded Seals

Consists of an outer stainless steel ring with a bonded Viton® inner ring used to seal a male ISO parallel thread.

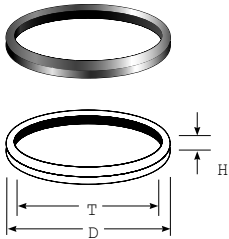

Part No.	T BSPP Thread	D (in.)	H (in.)
M30201-SS	1/8	.63	.08
M30202-SS	1/4	.81	.08
M30203-SS	3/8	.94	.08
M30204-SS	1/2	1.12	.10
M30206-SS	3/4	1.38	.10
M30208-SS	1	1.69	.10

Pressure Ratings For Sealing Washers		
Thread Size	PSI	Bar
1/8	5300	370
1/4	5500	380
3/8	4400	300
1/2	4000	280
3/4	3700	260
1	2800	190

These seals are also available in steel with a Nitrile inner ring. Simply replace Suffix SS with S.

Copper Washers

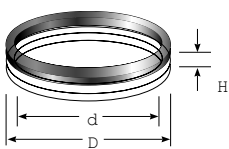

For BSPP male thread sealing

Part No.	Thread	D* (in.)	d (in.)	H (in.)
M28329	1/8	.71	.39	.09
M28330	1/4	.87	.55	.09
M28331	3/8	.94	.67	.09
M28332	1/2	1.18	.87	.10
M28334	3/4	1.38	1.06	.09
M28336	1	1.65	1.34	.09

For BSPP female thread sealing

Part No.	Thread	D (in.)	d (in.)	H (in.)
M25179	1/8	0.322	0.188	0.062
M25180	1/4	0.436	0.250	0.062
M25181	3/8	0.574	0.375	0.062
M25182	1/2	0.719	0.500	0.062
M25184	3/4	0.935	0.719	0.062
M25186	1	1.178	0.969	0.093

Used to provide a seal with male or female parallel ISO threads.

* Gasket fits ISO 1179-1 type G/H port.

Please note the pressure ratings are based on taper threaded ends. The pressure rating for the BSPP ends are dependent on the type of sealing washer used.

Dimensions for reference only, subject to change.

ISO Conversion Fittings

Pipe Data and Dimensions

Pipe Size (Inches)	Schedule #	Iron Pipe Size	Dimensions		
			Outside Diameter (Inches)	Inside Diameter (Inches)	Wall Thickness (Inches)
1/8	-	-	0.405	0.307	0.049
	40	STD		0.269	0.068
1/4	80	XS	0.540	0.215	0.095
	-	-		0.410	0.065
3/8	40	STD	0.675	0.364	0.088
	80	XS		0.302	0.119
1/2	-	-	0.840	0.545	0.065
	40	STD		0.493	0.091
	80	XS		0.423	0.126
	160	-		0.710	0.065
	-	XXS		0.674	0.083
3/4	-	-	1.050	0.622	0.109
	40	STD		0.546	0.147
	80	XS		0.466	0.187
	160	-		0.920	0.065
	-	XXS		0.884	0.083
1	-	-	1.315	0.824	0.113
	40	STD		0.742	0.154
	80	XS		0.612	0.219
	160	-		1.185	0.065
	-	XXS		1.097	0.109
1-1/4	-	-	1.660	1.049	0.133
	40	STD		0.957	0.179
	80	XS		0.815	0.25
	160	-		1.530	0.065
	-	XXS		1.442	0.109
1-1/2	-	-	1.900	1.38	0.140
	40	STD		1.278	0.191
	80	XS		1.160	0.250
	160	-		1.770	0.065
	-	XXS		1.682	0.109
2	-	-	2.375	1.610	0.145
	40	STD		1.338	0.281
	80	XS		1.100	0.400
	160	-		2.245	0.065
	-	XXS		2.157	0.109
				2.067	0.154
				1.939	0.218
				1.687	0.344
				1.503	0.436

High Pressure 10k Pipe Fittings

Visual Index

Pipe Fittings

Male Hex Long Nipple

MHLN
page 138



Female Cross

FX
page 141



Adapter

RA
page 138



Pipe Cap

CP
page 141



Male Hex Nipple

MHN
page 138

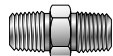

Female Hex Coupling

FHC
page 139



Reducing Bushing

RB
page 139



Male Elbow

ME
page 139



Male Tee

MT
page 140



Street Elbow

SE
page 140



Female Elbow

FE
page 140



Female Tee

FT
page 141

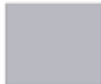

High Pressure 10k Pipe Fittings

Features and Technical Data

Parker High Pressure 10k Pipe Fittings are precision machined from bar stock. They are designed to be used for process control connections between pipe sizes.

Features

- Quality engineered for high pressure applications
- Packaged in sealed boxes for cleanliness
- Working pressures calculated in accordance with Power Piping Code ANSI B31.1 and Refinery Piping Code ANSI B31.3.
- All pipe threads are National Pipe Taper (NPT) and exceed the requirements of ANSI B1.20.1.
- Fittings machined from applicable ASTM bar stock specifications

Pipe Dimensions

Pipe Size	N.P.T. Pipe Thread	R	E Ref.
1/8	1/8 - 27	.38	.157
1/4	1/4 - 18	.56	.216
3/8	3/8 - 18	.56	.303
1/2	1/2 - 14	.75	.390

NPT Threads

The National Pipe Taper (NPT) thread has a thread flank angle of 60° inclusive, and is mainly used in the petrochemical and process industries.

NPT – National Pipe Taper threads for connections where pressure-tight joints are made on the threads utilizing a thread sealant.

System Temperature

Operating temperatures could be a factor resulting in a lower pressure rating being applied to these 10k psi rated High Pressure Pipe Fittings. The 10,000-psi (690 bar) pressure rating is based on ambient temperatures (22°C/72°F). For elevated temperature conditions a derating factor should be applied as listed in the table below.

Simply locate the correct factor and multiply by 10,000 to establish the appropriate elevated temperature working pressure.

The recommended temperature range for AISI 316L Stainless Steel is -255°C to 649°C (425°F to 1,200°F) but consideration should be given to media for operating temperatures above 427°C (800°F) as 300 series Stainless Steels are susceptible to carbide precipitation, which may lead to intergranular corrosion at elevated temperatures.

- Size ranges from 1/8" through 1/2" NPT. (Other sizes may be available upon request.)
- Materials 316L Stainless Steel. (Other materials by special order)
- All exposed threads protected to prevent damage

Nomenclature

Parker Instrument Pipe Fittings part numbers are constructed from symbols that identify the size and style of the fitting and material used.

Example: The part number shown below is for a male hex nipple for 3/8" NPT male pipe and 1/4" NPT male pipe in 316 stainless steel.

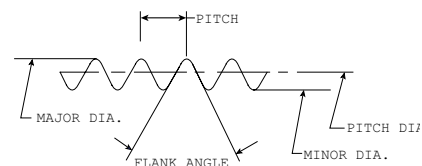
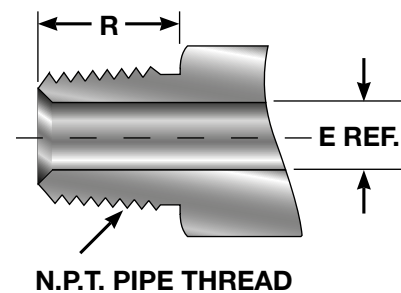

Temperature Derating Factors for 316L Stainless Steel		
Temperature °C	Temperature °F	Derating Factor
150 and below	300 and below	1.00
204	400	0.97
260	500	0.90
316	600	0.85
371	700	0.82
427	800	0.80
486	900	0.78
538	1000	0.77
593	1100	0.62
649	1200	0.37

High Pressure 10k Pipe Fittings

How to Order example

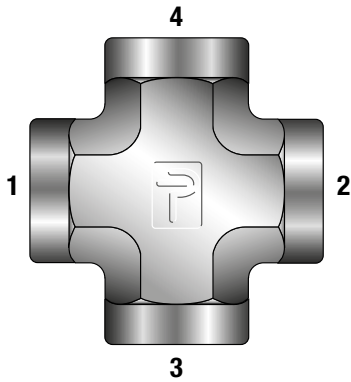
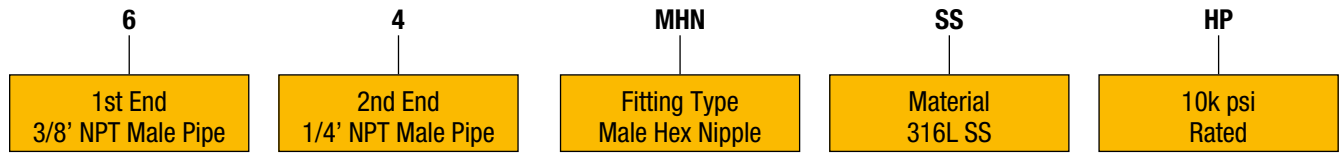

Parker High Pressure 10k Pipe Fittings are ordered by part number as listed in this catalog.

Size: Pipe thread sizes are designated by the number of sixteenths of an inch. (3/8 NPT pipe=6/16=6)

Thread Type: All pipe threads are National Pipe Taper (NPT) unless otherwise designated.

Straights and Elbows: Call out the largest pipe end first followed by the smaller pipe size. See MHN example on page 138.

Tees and Crosses: For tees that are the same pipe sizes on all ends the size designation is as follows: 6-6-6 FT would be

a 3/8" NPT Female Tee.

A 1/4" NPT Female Cross in 316L would be a 4 FX-SSHP.

If a reducing tee or cross were specified, each size must be in sequence. First size the largest run (1 to 2) and then the branch (3 to 4).

Example: 6-6-6-4 FX-SSHP

Material: Basic Material Type (SS=316L Stainless Steel)

Special Fittings: If there is any question as to the fitting desired, particularly for special fitting configurations, it is suggested that a customer sketch of what is required be submitted with the request for quote.

Dimensions for reference only, subject to change.

High Pressure 10k Pipe Fittings

Male Hex Long Nipple MHLN

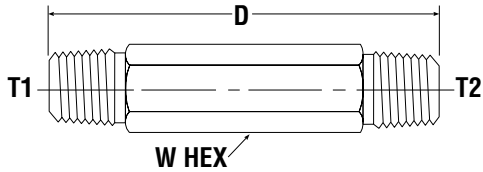

Parker Part No.	NPT THREAD MALE			
	T ₁	T ₂	W Hex	D ins.
4-4 MHLN-3-SSHP	1/4	1/4	5/8	3.00
4-4 MHLN-4-SSHP	1/4	1/4	5/8	4.00
6-6 MHLN-3.0-SSHP	3/8	3/8	3/4	3.00
6-6 MHLN-4.0-SSHP	3/8	3/8	7/8	4.00
8-8 MHLN-2-SSHP	1/2	1/2	7/8	2.00
8-8 MHLN-3	1/2	1/2	7/8	3.00

Adapter RA

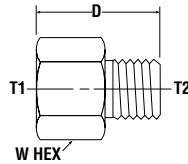
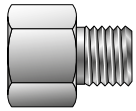

Parker Part No.	NPT THREAD MALE			
	Female T ₁	Male T ₂	W Hex	D ins.
4-2 RA-SSHP	1/4	1/8	3/4	1.20
4-4 RA-SSHP	1/4	1/4	3/4	1.39
6-2 RA-SSHP	3/8	1/8	7/8	1.25
6-4 RA-SSHP	3/8	1/4	7/8	1.44
6-6 RA-SSHP	3/8	3/8	7/8	1.44
8-4 RA-SSHP	1/2	1/4	1-1/8	1.69
8-6 RA-SSHP	1/2	3/8	1-1/8	1.69
8-8 RA-SSHP	1/2	1/2	1-1/8	1.88

Male Hex Nipple MHN

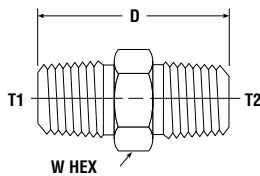
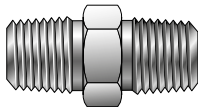

Parker Part No.	NPT THREAD MALE			
	T ₁	T ₂	W Hex	D ins.
2-2 MHN-SSHP	1/8	1/8	7/16	1.06
4-2 MHN-SSHP	1/4	1/8	5/8	1.25
4-4 MHN-SSHP	1/4	1/4	5/8	1.45
6-2 MHN-SSHP	3/8	1/8	3/4	1.27
6-4 MHN-SSHP	3/8	1/4	3/4	1.45
6-6 MHN-SSHP	3/8	3/8	3/4	1.45
8-2 MHN-SSHP	1/2	1/8	7/8	1.52
8-4 MHN-SSHP	1/2	1/4	7/8	1.70
8-6 MHN-SSHP	1/2	3/8	7/8	1.70
8-8 MHN-SSHP	1/2	1/2	7/8	1.89

Dimensions for reference only, subject to change.

High Pressure 10k Pipe Fittings

Female Hex Coupling FHC

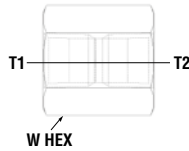

Parker Part No.	NPT THREAD FEMALE			
	T ₁	T ₂	W Hex	D ins.
2-2 FHC-SSHP	1/8	1/8	5/8	.75
4-2 FHC-SSHP	1/4	1/8	3/4	.94
4-4 FHC-SSHP	1/4	1/4	3/4	1.13
6-2 FHC-SSHP	3/8	1/8	7/8	1.03
6-4 FHC-SSHP	3/8	1/4	7/8	1.13
6-6 FHC-SSHP	3/8	3/8	7/8	1.13
8-2 FHC-SSHP	1/2	1/8	1-1/8	1.22
8-4 FHC-SSHP	1/2	1/4	1-1/8	1.38
8-6 FHC-SSHP	1/2	3/8	1-1/8	1.50
8-8 FHC-SSHP	1/2	1/2	1-1/8	1.50

Reducing Bushing RB

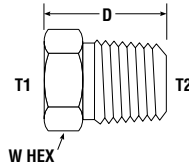
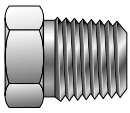

Parker Part No.	NPT THREAD			
	Male T ₂	Female T ₁	W Hex	D ins.
4-2 RB-SSHP	1/4	1/8	5/8	.86
6-4 RB-SSHP	3/8	1/4	3/4	.86
8-2 RB-SSHP	1/2	1/8	7/8	1.11
8-4 RB-SSHP	1/2	1/4	7/8	1.11
8-6 RB-SSHP	1/2	3/8	7/8	1.11
12-4 RB-SSHP	3/4	1/4	1-1/8	1.17
16-4 RB-SSHP	1	1/4	1-3/8	1.36

Male Elbow ME

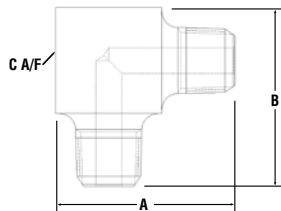

Part No.	Thread Size	A ins.	B ins.	C A/F ins.
2-2ME-SSHP	1/8"	0.69	0.69	0.63
4-4ME-SSHP	1/4"	0.94	0.94	0.75
6-6ME-SSHP	3/8"	0.97	0.97	0.75
8-8ME-SSHP	1/2"	1.31	1.31	1.00

Dimensions for reference only, subject to change.

High Pressure 10k Pipe Fittings

Male Tee MT

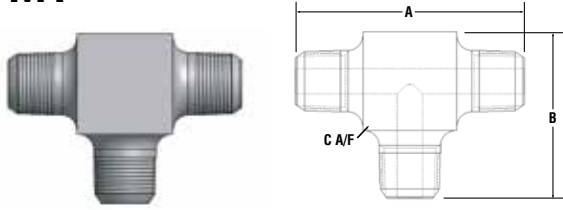

Part No.	Thread Size	A ins.	B ins.	C A/F ins.
2-2-2MT-SSHP	1/8"	1.38	0.69	0.63
4-4-4MT-SSHP	1/4"	1.88	0.94	0.75
6-6-6MT-SSHP	3/8"	1.94	0.97	0.75
8-8-8MT-SSHP	1/2"	2.62	1.31	1.00

Street Elbow SE

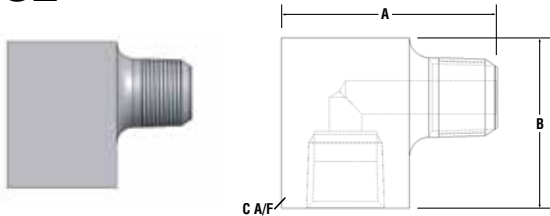

Part No.	Thread Size	A ins.	B ins.	C A/F ins.
2-2SE-SSHP	1/8" x 1/8"	1.20	0.90	0.75
4-4SE-SSHP	1/4" x 1/4"	1.30	1.00	1.00
6-6SE-SSHP	3/8" x 3/8"	1.40	1.10	1.25
8-8SE-SSHP	1/2" x 1/2"	1.60	1.25	1.50

Female Elbow FE

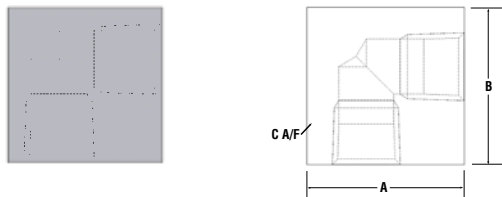

Part No.	Thread Size	A ins.	B ins.	C A/F ins.
2-2FE-SSHP	1/8"	1.12	1.12	0.75
4-4FE-SSHP	1/4"	1.50	1.50	1.00
6-6FE-SSHP	3/8"	1.95	1.95	1.25
8-8FE-SSHP	1/2"	2.00	2.00	1.50

Dimensions for reference only, subject to change.

High Pressure 10k Pipe Fittings

Female Tee FT

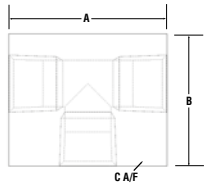
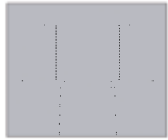

Part No.	Thread Size	A ins.	B ins.	C A/F ins.
2-2-2FT-SSHP	1/8"	1.50	1.12	0.75
4-4-4FT-SSHP	1/4"	2.00	1.50	1.00
6-6-6FT-SSHP	3/8"	2.50	1.95	1.25
8-8-8FT-SSHP	1/2"	2.50	2.00	1.50

Female Cross FX

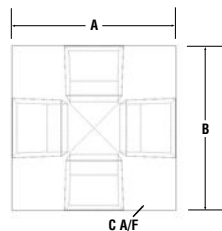
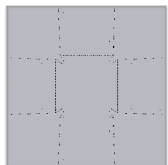

Part No.	Thread Size	A ins.	B ins.	C A/F ins.
2FX-SSHP	1/8"	1.50	1.50	0.75
4FX-SSHP	1/4"	2.00	2.00	1.00
6FX-SSHP	3/8"	2.50	2.50	1.25
8FX-SSHP	1/2"	2.50	2.50	1.50

Pipe Cap CP

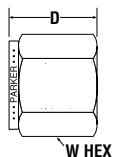
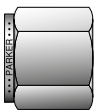

Parker Part No.	NPT Thread Female	W Hex	D ins.
2 CP-SSHP	1/8	.710	.625
4 CP-SSHP	1/4	.945	.875
6 CP-SSHP	3/8	1.181	1.000
8 CP-SSHP	1/2	1.500	1.350

Dimensions for reference only, subject to change.

Phastite® Connectors: Visual Index

PS
Permanent Union
Equal Straight
page 160

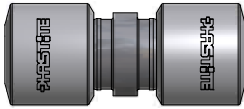

PE
Permanent Union
Equal Elbow
page 161



PT
Permanent Union
Equal Tee
page 162

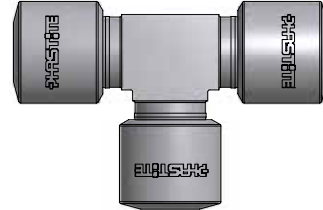

PC
Permanent Union
Equal Cross
page 163



PS
Permanent Union
Drop Size
page 164

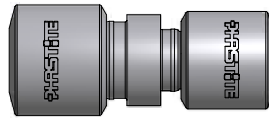

TMS-N
Termination Male Straight -
NPT
page 165

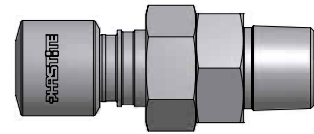

TFS-N
Termination Female Straight -
NPT
page 166

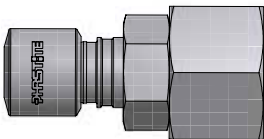

TMS-R
Termination Male Straight -
BSPP
page 167

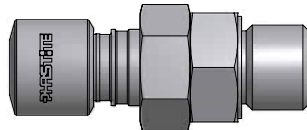

TFS-R
Termination Female Straight -
BSPP
page 168

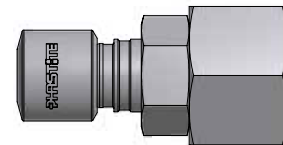

Permanent Compression
Instrument Fittings

**Phastool® 3A
Hand Held**
page 169



Phastool® 3B
page 171



Tri-Tool® Bench Tool
page 174



Phastool® Jaw Inserts
page 175



Tri-Tool® Jaw Inserts
page 175



Tubemarker
page 176



The Concept

A Ferrule-less, Push-Fit Connector

Phastite® is a breakthrough in tube connection systems; its innovative design concept eliminates the costly requirement of welding and combines quick installation with a single assembly process achieving a tube connector that can be used in applications up to 22,500 psi (1,550 bar) and temperatures ranging from -45°C to 93°C (-50°F to 200°F). Already being used on thousands of applications worldwide, Parker is confident that Phastite® can make your processes Smarter, Faster, Cleaner, Safer.

Design

Phastite® has been specifically designed to meet ever-increasing industry standards and demands with regards to tube connectors and pressure containment. The latest computer aided engineering (CAE) and finite element analysis (FEA) techniques have been employed to optimise the design of the connectors and assembly tooling.

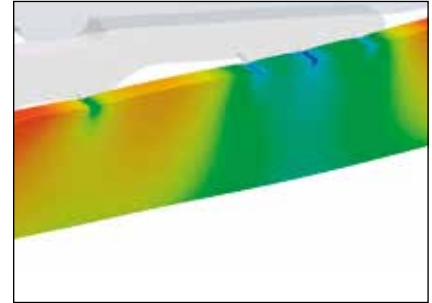

Manufacturing

State of the art machining centres and over 100 years of connector manufacturing has been utilised for accurate and consistent manufacturing of Phastite® connectors. Phastite® is manufactured in Parker's facilities where strict quality controls are employed to ensure reliability and consistency.



Permanent Compression
Instrument Fittings

Testing

Phastite® meets all the relevant performance and functional requirements of industry standards, including pressure containment. Throughout the development of Phastite®, product performance and integrity were paramount. The testing performed included a combination of hyperbaric, thermal cycling, vibration along different axes, flex fatigue, tensile pull test, torsion, helium leak, gas tight and hydrostatic testing.

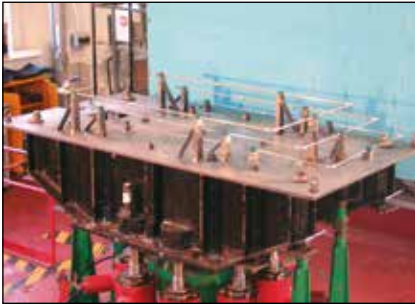

Materials

Phastite® can be manufactured in 316 Stainless Steel and corrosion resistant alloys including INCONEL® Alloy 625, INCOLOY® Alloy 825 and Super Duplex to cope with the most demanding environments, from subsea exploration in the north sea to natural gas drilling in Kazakhstan.

Note: INCONEL® and INCOLOY® are registered trademarks of Special Metals Corporation.



The Benefits

Safety

- Supplied pre-assembled, no loose parts thus eliminating potential assembly errors
- No additional operations using equipment that could lead to injury are required
- Permanent assembly is tamper proof
- Permanent leak free connections without the need for threaded components, thus removing potential loosening problems due to excess movement
- No Hot Work! Fire or explosion risks are eliminated along with any potential fume inhalation
- No disposal of hazardous materials used in any Hot Work activities
- No brittleness or corrosion implications (caused by welding heat for example)



Permanent Compression
Instrument Fittings

Installation

- Simple installation process removes the need for skilled labour. The Phastool® and Tri-Tool® assures Phastite® connections are right the first time, every time
- Assembled in seconds, reducing assembly and project lead times
- Suitable for a wide variety of markets and applications
- Tolerant of tubing variation and defects, reducing work and re-testing
- Easy in-situ assembly, even close up against panels/bulkheads
- Eliminates the need for orbital welding equipment

Cost of Ownership

- No inspection requirements such as X-Ray or Dye penetrant testing during installation
- No re-work, just fit and forget
- No consumables such as welding rods, gases or cutting oil
- No Hot Work permits required
- Potential tube cost and weight savings (Phastite® is suitable for use on a wide range of wall thicknesses – including thin wall tube for gas applications)

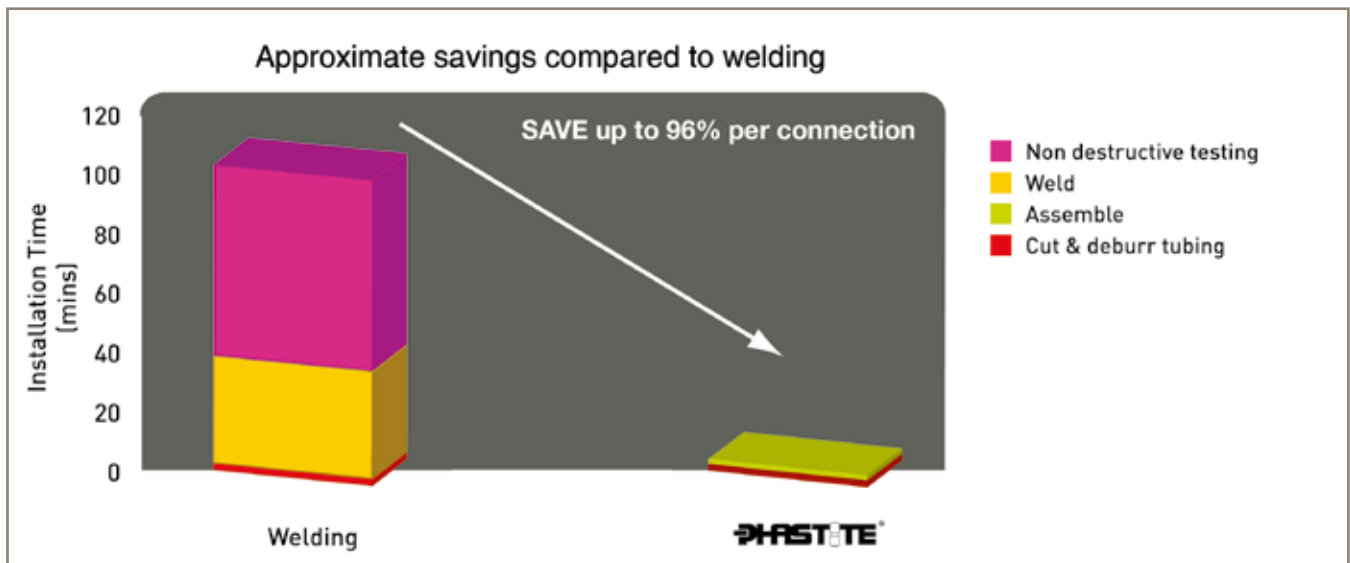

Value Proposition

Reduced installation costs

Phastite® offers an extremely quick, easy and simple way of connecting tubing. When considering how much time it takes to either weld or cone and thread tubing, Phastite® delivers a large reduction in total cost.

Simple assembly process

The Phastite® tooling, together with the connector's unique design ensures a leak free connection first time, every time. This reduces assembly time from hours to seconds.

No need to re-make or re-test

Phastite® delivers a leak free connection with no need for costly and time consuming re-making or re-testing.

No welding required

With Phastite® a permanent connection can be made in seconds without the need for certified labour or costly testing requirements.

Reduced tubing costs

Phastite® is used with standard tubing material. Controlled chemical composition or special tubing tolerances are not needed.

No special requirements

Standard tubing is all that is required.

Weight reduction

The need for extra wall thickness to allow threading is eliminated, meaning that weight as well as the tubing costs are reduced.

Increased safety

Phastite's simple assembly process reduces the number of operations needed to assemble a leak free joint. Simply insert the tubing into the pre-assembled connector. The Phastite® tooling delivers a leak free connection.

No loose parts

Phastite® connectors are supplied pre-assembled, no loose parts and no disassembling needed by the installer. This eliminates errors when assembling, as there are no parts to lose or to incorrectly assemble.

Simple make-up

Consistent make-up to a pre-determined stop face on the body. No measuring, simply insert the tube into the connector and let the tool do the rest. This reduces the possibility of any incorrect make-up.

Vibration tolerant

Phastite® provides a permanent leak free connection. There are no threaded components, removing potential loosening problems in vibration applications.

No need for hot work

Phastite® provides a leak free connection suitable for replacing welded systems, removing the associated risks with welding.

Approval

DNV approved.

Sealing

Phastite® Permanent Connectors



Phastite® permanent connectors use patented sealing technology to provide a unique permanent joint onto standard commercial grade tubing. The robust design ensure leak free performance in the most demanding of applications, and yet can be assembled in seconds with no manual effort.

Phastite's unique sealing ability allows the same product to be used on the extremes of tube wall thickness, ranging from thin wall sections as low as 0.035" (0.9mm) for light weight low pressure applications, to 0.188" (4.8mm) for high pressure thick wall systems.

The excellent sealing and holding properties of Phastite® is achieved by its unique design. It not only secures metal to metal sealing points onto the tubing from its unique formed peaks within the bore of the connector body but allows the tubing to expand into the pre-machined cavities giving additional holding properties.

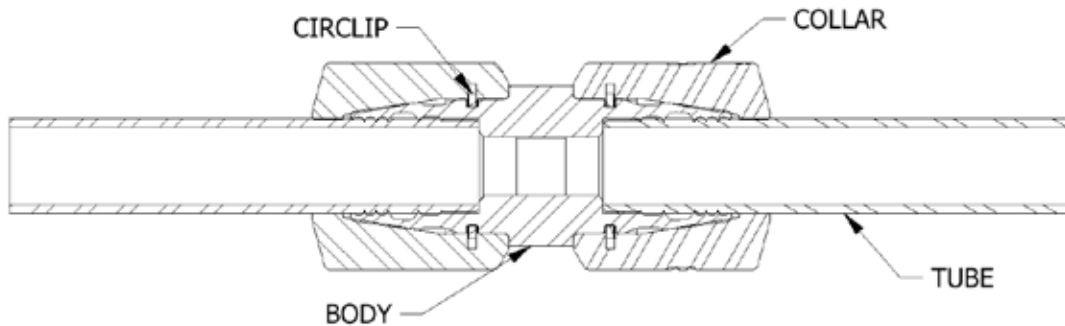

Phastite® Termination Connectors



Phastite® termination connectors use the same patented sealing technology as the permanent connector to provide a unique joint onto standard tubing, with the additional ability of being able to 'break' and 'remake' the joint.

The design maintains the unique abilities of the permanent connector but provides an additional joint which provides the ability for installations to be maintained.

The Assembly Process

Phastite® Permanent Connectors

The Phastite® fitting is supplied complete with the collars pre-assembled to the body, thus removing the risk of losing or incorrectly assembling components.



The tubes are simply inserted into the Phastite® connector, adequate tube insertion is assured by using the Phastite® tube marker.

Simple assembly to a metal to metal stop face ensures correct assembly every time, without counting turns or monitoring torque levels.



A series of formed ridges makes contact with the tubing surface uniformly to create both a multiple seal and a secure mechanical grip, rotationally and axially.



Phastite® Termination Connectors

The Phastite® fitting is supplied complete with the collars pre-assembled to the body, retaining the swivel nut, thus removing the risk of losing or incorrectly assembling components.



The tubes are simply inserted into the Phastite® connector, adequate tube insertion is assured by using the Phastite® tube marker.

Simple assembly to a metal to metal stop face ensures correct assembly every time, without counting turns or monitoring torque levels.



A series of formed ridges makes contact with the tubing surface uniformly to create both a multiple seal and a secure mechanical grip.

A mating conical arrangement provides leak tight sealing at the breakable joint, while correct assembly is ensured by a metal to metal stop face, without counting turns or monitoring torque levels.

The ability to 'break' and 'remake' the joint is enhanced by the virtual zero clearance of the design. Allowing the joint to be completely disconnected and removed without large pull out being required.

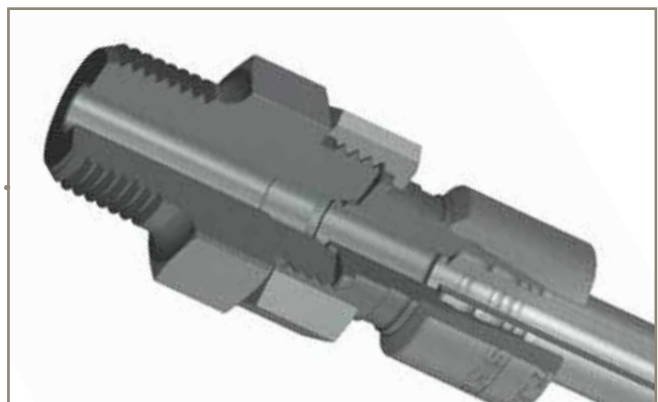

Permanent Compression
Instrument Fittings

Tube Selection and Pressure Ratings

General selection criteria

Phastite® tube connectors have been designed to work in a wide variety of applications that demand the utmost in product performance. Although Phastite® connectors have been engineered and manufactured to consistently provide this level of reliability, no system integrity is complete without considering the critical link, tubing.

This guide is intended to assist the designer to properly select and order the correct quality tubing. Correct tube selection and installation are key ingredients in building leak-free reliable tubing systems. The most important consideration in the selection of suitable tubing for any application is the compatibility of the tubing material with the media to be contained. In addition tubing compatibility with the connector should be considered, as dissimilar materials in contact may be susceptible to galvanic corrosion. The differential in material hardness may also affect their ability to correctly hold onto and seal the tubing.

Pressure ratings for combinations of tube and connector

The pressure rating of a Phastite® connection assembly is that of the tube with the highest-pressure rating to which it can be attached and is presented in the Pressure Rating Tables on pages 153 to 155. The pressure rating of the tube has been calculated in accordance with ASME B31.3, Chemical Plant and Petroleum Refinery Piping standard, assuming maximum diameter, minimum wall thickness and minimum yield stress.

In the case of an all tube-ended connector, such as a union tee, the properly selected tubing is the limiting factor in the system. A termination connector may, however, combine a Phastite® connector end with another end of different form, such as male or female pipe thread. Pressure ratings for other ends are determined in accordance with applicable standards and may, in fact, be lower than the rating for the Phastite® tube connector end.

Pressure rating and wall thickness of tubes

The pressure rating table presents the pressure ratings for type 316 Stainless Steel, INCONEL® Alloy 625, INCOLOY® Alloy 825 and Super Duplex seamless tubes for temperatures up to 93°C (200°F).

This table also shows the minimum and maximum wall thickness of tubes that shall be used within the scope of the Parker Phastite® design for each size of tube connector. If a user chooses a tube wall thickness outside those recommended in the following tables, the user should first consult the technical department of Parker Instrumentation Products Division.



Derivation of pressure ratings

The working pressure ratings for tubing shall be derived from stress values and methodologies listed in ASME B31.3.

Pressure Rating Tables

Phastite® Permanent Connectors

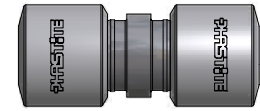

Tube Material	Tube O.D.	Wall Thickness - Maximum Tube Assembly Rating - PSI (bar)*						
		0.035	0.049	0.065	0.083	0.095	0.154	0.188
Stainless Steel 316 (ASTM A269)	1/4"	5,100 (350)	7,500 (510)	10,300 (710)	13,300 (910)			
	3/8"	3,300 (220)	4,800 (330)	6,600 (450)	8,600 (590)	10,000 (680)		
	1/2"	2,600 (170)	3,700 (250)	5,100 (350)	6,700 (460)	7,800 (530)		
	5/8"		2,950 (200)	4,000 (270)	5,200 (350)	6,050 (410)		
	3/4"		2,400 (160)	3,300 (220)	4,250 (290)	4,950 (340)	8,650 (590)	
	1"			2,400 (160)	3,150 (210)	3,650 (250)	6,250 (430)	7,750 (530)
INCONEL® Alloy 625 (ASTM B444-06)	1/4"	11,000 (750)	16,100 (1110)	22,500 (1550)				
	3/8"	7,100 (480)	10,200 (700)	14,000 (960)	18,700 (1280)			
	1/2"	5,200 (350)	7,500 (510)	10,200 (700)	13,400 (920)			
	5/8"			8,000 (550)	10,400 (710)			
	3/4"			6,600 (450)	8,500 (580)	9,900 (680)	17,400 (1190)	
INCOLOY® Alloy 825 (ASTM B423)	1/4"	6,400 (440)	9,300 (640)	13,100 (900)	17,900 (1230)			
	3/8"	4,100 (280)	5,900 (400)	8,200 (560)	10,900 (750)			
	1/2"	3,000 (200)	4,300 (290)	5,900 (400)	7,800 (530)			
	5/8"			4,600 (310)	6,100 (420)			
	3/4"			3,800 (260)	5,000 (340)	5,800 (390)	10,100 (690)	
Super Duplex (ASTM A789/ A789M)	1/4"		14,600 (1000)	20,400 (1400)				
	3/8"	6,400 (440)	9,300 (640)	12,700 (870)	16,900 (1160)			
	1/2"	4,700 (320)	6,800 (460)	9,200 (630)	12,100 (830)			
	5/8"			7,200 (490)	9,500 (650)	11,000 (750)		
	3/4"			5,900 (400)	7,800 (530)			

Table - Pressure Rating for Permanent Connectors (Imperial)*

Tube Material	Tube O.D.	Wall Thickness - Maximum Tube Assembly Rating - PSI (bar)*								
		1	1.2	1.5	1.8	2	2.2	3.5	4	4.5
Stainless Steel 316 (ASTM A269)	6mm	6,600 (450)	8,200 (560)	10,700 (730)	13,400 (920)	15,400 (1060)				
	10mm	3,800 (260)	4,600 (310)	5,900 (400)	7,300 (500)	8,300 (570)	9,200 (630)			
	12mm	3,100 (210)	3,800 (260)	4,800 (330)	5,900 (400)	6,700 (460)	7,500 (510)			
	16mm	2,300 (150)	2,800 (190)	3,500 (240)	4,300 (290)	4,800 (330)	5,400 (370)	6,200 (420)		
	20mm			2,800 (190)	3,400 (230)	3,800 (260)	4,200 (280)	7,100 (480)	8,300 (480)	
	25mm			2,200 (150)	2,700 (180)	3,000 (200)	3,300 (220)	5,500 (370)	6,400 (370)	7,300 (440)
INCONEL® Alloy 625 (ASTM B444-06)	6mm	13,300 (910)	16,400 (1130)	21,400 (1470)						
	10mm	7,600 (520)	9,300 (640)	11,900 (820)	14,700 (1010)	16,600 (1140)				
	12mm	6,300 (430)	7,600 (520)	9,700 (660)	11,900 (820)	13,400 (920)				
	16mm			7,100 (480)	8,700 (590)	9,700 (660)				
	20mm			5,600 (380)	6,800 (460)	7,600 (520)	8,500 (580)	14,300 (980)		
INCOLOY® Alloy 825 (ASTM B423)	6mm	7,700 (530)	9,500 (650)	12,500 (8660)	15,600 (1070)	17,900 (1230)				
	10mm	4,400 (300)	5,400 (370)	6,900 (470)	8,500 (580)	6,900 (660)				
	12mm	3,600 (240)	4,400 (300)	5,600 (380)	6,900 (470)	7,800 (530)				
	16mm			4,100 (280)	5,000 (340)	5,700 (390)				
	20mm			3,200 (220)	3,900 (260)	4,400 (300)	4,900 (330)	8,300 (570)		
Super Duplex (ASTM A789/ A789M)	6mm			19,500 (1340)						
	10mm	6,900 (470)	8,400 (570)	10,800 (740)	13,300 (910)	15,000 (1030)				
	12mm	5,700 (390)	6,900 (470)	8,800 (600)	10,800 (740)	12,200 (840)				
	16mm			6,500 (440)	7,900 (540)	8,800 (600)	9,800 (670)			
	20mm				6,200 (420)	6,900 (470)				

Table - Pressure Rating for Permanent Connectors (Metric)*

Tooling

Phastool® 3A, 3B and Tri-Tool®

Phastool®3B and Tri-Tool®

* The working pressure ratings for tubing in tables 1 to 4 are calculated directly from ASME B31.3

Permanent Compression Instrument Fittings

Phastite® Termination Connectors

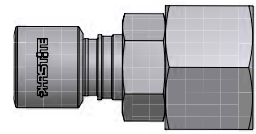

Tube Material	Tube O.D.	Thread Size	Wall Thickness - Maximum Tube Assembly Rating - PSI (bar)*							
			0.035	0.049	0.065	0.083	0.095	0.154	0.188	
Stainless Steel 316 (ASTM A269)	1/4"	1/4"	5,100 (350)	7,500 (510)	9,130 (630)	9,130 (630)				
	3/8"	1/4"	3,300 (220)	4,800 (330)	6,600 (450)	8,600 (590)	9,130 (630)			
	3/8"	3/8"	3,300 (220)	4,800 (330)	6,600 (450)	8,600 (590)	8,700 (600)			
	1/2"	1/2"	2,600 (170)	3,700 (250)	5,100 (350)	6,700 (460)	7,250 (500)			
	5/8"	3/4"		2,950 (200)	4,000 (270)	5,200 (350)	5,800 (400)			
	3/4"	3/4"		2,400 (160)	3,300 (220)	4,250 (290)	4,950 (340)	5,800 (400)		
INCONEL® Alloy 625 (ASTM B444-06)	1/4"	1/4"			2,400 (160)	3,150 (210)	3,150 (210)	5,800 (400)	5,800 (400)	
	3/8"	1/4"	10,000 (690)	10,000 (690)	10,000 (690)					
	3/8"	3/8"	7,100 (480)	10,000 (690)	10,000 (690)	10,000 (690)				
	1/2"	1/2"	7,100 (480)	9,570 (660)	9,570 (660)	9,570 (660)				
	5/8"	3/4"	5,200 (350)	7,500 (510)	7,970 (550)	7,970 (550)				
	3/4"	3/4"			6,090 (420)	6,090 (420)	6,090 (420)	6,090 (420)		
INCOLOY® Alloy 825 (ASTM B423)	1/4"	1/4"			6,090 (420)	6,090 (420)	6,090 (420)	6,090 (420)		
	3/8"	1/4"	6,400 (440)	9,130 (630)	9,130 (630)	9,130 (630)				
	3/8"	3/8"	4,100 (280)	5,900 (400)	8,200 (560)	9,130 (630)				
	1/2"	1/2"	4,100 (280)	5,900 (400)	8,200 (560)	8,700 (600)				
	5/8"	3/4"	3,000 (200)	4,300 (290)	5,900 (400)	7,250 (500)				
	3/4"	3/4"			4,600 (310)	5,800 (400)				
Super Duplex (ASTM A789/ A789M)	1/4"	1/4"			3,800 (260)	5,000 (340)	5,800 (400)	5,800 (400)		
	3/8"	1/4"		10,000 (690)	10,000 (690)					
	3/8"	3/8"	6,400 (440)	9,300 (640)	10,000 (690)	10,000 (690)				
	1/2"	1/2"	6,400 (440)	9,300 (640)	9,570 (660)	9,570 (660)				
	5/8"	3/4"	4,700 (320)	6,800 (460)	7,970 (550)	7,970 (550)				
	3/4"	3/4"			6,090 (420)	6,090 (420)	6,090 (420)			

Table - Pressure Rating for BSPP and NPT Termination Connectors (Imperial)*

Permanent Compression Instrument Fittings

Tube Material	Tube O.D.	Thread Size	Wall Thickness - Maximum Tube Assembly Rating - PSI (bar)*									
			1	1.2	1.5	1.8	2	2.2	3.5	4	4.5	
Stainless Steel 316 (ASTM A269)	6mm	1/4"	6,600 (450)	8,200 (560)	9,130 (630)	9,130 (630)	9,130 (630)					
	10mm	1/4"	3,800 (260)	4,600 (310)	5,900 (400)	7,300 (500)	8,300 (570)	9,130 (630)				
	10mm	3/8"	3,800 (260)	4,600 (310)	5,900 (400)	7,300 (500)	8,300 (570)	8,700 (600)				
	12mm	1/2"	3,100 (210)	3,800 (260)	4,800 (330)	5,900 (400)	6,700 (460)	7,250 (500)				
	16mm	3/4"	2,300 (150)	2,800 (190)	3,500 (240)	4,300 (290)	4,800 (330)	5,400 (370)	5,800 (400)			
	20mm	3/4"			2,800 (190)	3,400 (230)	3,800 (260)	4,200 (280)	5,800 (400)	5,800 (400)		
	25mm	1"			2,200 (150)	2,700 (180)	3,000 (200)	3,300 (220)	5,500 (370)	5,800 (400)	5,800 (400)	
INCONEL® Alloy 625 (ASTM B444-06)	6mm	1/4"	10,000 (690)	10,000 (690)	10,000 (690)							
	10mm	1/4"	7,600 (520)	9,300 (640)	10,000 (690)	10,000 (690)	10,000 (690)					
	10mm	3/8"	7,600 (520)	9,300 (640)	9,570 (660)	9,570 (660)	9,570 (660)					
	12mm	1/2"	6,300 (430)	7,600 (520)	7,970 (550)	7,970 (550)	7,970 (550)					
	16mm	3/4"			6,090 (420)	6,090 (420)	6,090 (420)					
	20mm	3/4"			5,600 (380)	6,090 (420)	6,090 (420)	6,090 (420)	6,090 (420)			
INCOLOY® Alloy 825 (ASTM B423)	6mm	1/4"	7,700 (530)	9,130 (630)	9,130 (630)	9,130 (630)	9,130 (630)					
	10mm	1/4"	4,400 (300)	5,400 (370)	6,900 (470)	8,500 (580)	6,900 (660)					
	10mm	3/8"	3,600 (240)	4,400 (300)	5,600 (380)	6,900 (470)	7,800 (530)					
	12mm	1/2"	3,600 (240)	4,400 (300)	5,600 (380)	6,900 (470)	7,250 (500)					
	16mm	3/4"			4,100 (280)	5,000 (340)	5,700 (390)					
	20mm	3/4"			3,200 (220)	3,900 (260)	4,400 (300)	4,900 (330)	5,800 (400)			
Super Duplex (ASTM A789/A789M)	6mm	1/4"			10,000 (690)							
	10mm	1/4"	6,900 (470)	8,400 (570)	10,000 (690)							
	10mm	3/8"	6,900 (470)	8,400 (570)	9,570 (660)	9,570 (660)	9,570 (660)					
	12mm	1/2"	5,700 (390)	6,900 (470)	7,970 (550)	7,970 (550)	7,970 (550)					
	16mm	3/4"			6,090 (420)	6,090 (420)	6,090 (420)	6,090 (420)				
	20mm	3/4"				6,090 (420)	6,090 (420)					

Table - Pressure Rating for BSPP and NPT Termination Connectors (Metric)*

Tooling

Tri-Tool® 

* The working pressure ratings for tubing in tables 1 to 4 are calculated directly from ASME B31.3

Pressure rating at elevated temperatures

To determine allowable pressure at elevated temperatures, multiply the allowable working pressure from tables 1 to 4 by the factor shown in the table here.

Example: 12mm x 1.5mm wall 316 stainless steel tubing has a working pressure of 317 bar @ room temperature. If the system were to operate at 426°C, a factor of 80% or 0.8 would apply and the “at temperature” system pressure would therefore be 317 x 0.8 = 254 bar.

These factors are based on ASME B31.3 derating factors for specific tubing materials. They are derived from table A-1, basic allowable stresses in metals.

°F	°C	316 SS	INCONEL® Alloy 625	INCOLOY® Alloy 825	Super Duplex
100	38	1	1	1	1
200	93	1	0.93	0.92	0.99
300	149	1	0.88	0.87	0.94
400	204	0.97	0.85	0.83	0.90
500	260	0.90	0.82	0.79	0.90
600	315	0.85	0.79	0.76	0.88
700	371	0.82	0.77	0.74	-
800	426	0.80	0.75	0.73	-
900	482	0.78	0.74	-	-
1000	537	0.77	0.73	-	-
1100	593	0.62	0.73	-	-
1200	649	0.37	0.72	-	-

Table - Factors used to determine tubing pressure ratings at elevated temperatures.

Tubing ordering suggestions

Tubing for use with Phastite® connectors should be ordered to insure adequate quality for good performance. Each request for tubing should specify the material, nominal outside diameter, and wall thickness. Ordering to the correct ASTM specifications ensures that the tubing will be dimensionally, physically and chemically within the strict limits as laid down in the standard.

In addition to this, the tubing should be ordered free from scratches and imperfections and suitable for bending or flaring. The tubing should be both annealed and of maximum hardness, as recommended in the below table, and delivered in a proper manner to preserve the product quality. The following grades and standards can be used successfully with Phastite® fittings:

Material	Type	ASTM Tubing Specification	Condition	Min. Recommended Hardness	Max. Recommended Hardness
Stainless Steel	304, 316, 316L	ASTM A269, A249, A213, A632	Fully Annealed	70 HRb	90 HRb
INCONEL® Alloy 625	625	ASTM B444	Grade 1 (Soft Annealed) and Grade 2 (Solution Annealed)	90 HRb	102 HRb
INCOLOY® Alloy 825	825	ASTM B423	Annealed	80 HRb	90 HRb
Super Duplex	Super Duplex	ASTM A269	Fully Annealed	23 HRC (240 HBW)	32 HRC (300 HBW)

Note on selection

The pressure rating information presented in these tables is intended as a useful guide to demonstrate the performance potential of the Phastite® connector when properly installed according to Parker recommended practices and to assist the user in the proper selection of tube and fitting for a particular application. Every effort is made to ensure this information is clearly presented but it is the responsibility of the user and the system designer to ensure the appropriate selection and specification of tube and fitting and that the specified assembly meets the requirements of the system or application.

Heat Code Traceability (HCT)

HCT refers to the fact that a specific part can be traced back to the original mill heat of metal from which it was made. Beginning with the original melt, a package of documents is created which completely describes the metal in physical and chemical terms. The end result is that a number, which is permanently stamped to the part, refers back to the document package.

HCT offers these advantages:

- Raw materials for manufacture must meet code requirements. This can be verified through documentation so that the customer is certain that what is ordered is received
- HCT provides a record of chemical analysis with the raw material
- HCT relieves the user of Parker instrumentation fittings of any doubts. It acts as an assurance for today and for tomorrow

The Phastite® connector is offered in four different materials:

- 316 Stainless Steel
- Incone® Alloy 625
- Incoloy® Alloy 825
- Super Duplex

In addition to the documentation of chemical and physical properties, great care is taken throughout the manufacture of Parker's connectors to ensure that potential stress corrosion will not be a problem in normal usage of the parts. Manufacturing processes avoid exposure of the parts to mercury or halogens, and control of thermal treatment avoids the condition known as continuous grain boundary carbide precipitation.

HCT Numbers



Testing

During the development of Phastite®, a very rigorous testing program was undertaken. This involved the testing of various connector types, including shapes and straights.

Alongside internal testing in our state-of-the-art facility, additional samples were sub-contracted for external testing to then be externally validated by DNV.

Phastite® met or exceeded all requirements including, but not limited to, the following tests:

Pressure containment

Hydrostatic testing was carried out for all tube sizes on the thickest and thinnest wall tubing as laid out in the tube selection guide on page 11. A large quantity of these tests have been carried out internally and externally and witnessed by various 3rd parties and customers. Phastite® product has been subjected to pressure of 1.5 times the tubes maximum working pressure to ensure adequate sealing and tube grip.

Flexural test

Flexural tests have been carried out fully in accordance to ISO 19879 and BS 4368 or ASTM F1387. The test specimen is pressurised to a pre-determined pressure and one end is oscillated at a high frequency. No pressure loss or visible leakage is acceptable throughout the test.



Flexural test

Combined pulsation and flexural

Combined pulsation and flexural tests have been carried out fully in accordance to ISO 19879 and BS 4368. The test specimen is pressurised with hydraulic fluid at a pre-determined pressure. The test specimen is subjected to both oscillation and pulsation forces at once to simulate an extreme service condition. No pressure loss or visible leakage is acceptable throughout the test.

Hydrostatic burst test

This test internally pressurises the complete Phastite® tube assembly until destruction. In all cases the tube has proven to be the weakest component within the assembly. The tests ensured that tube burst was achieved on all sizes without any movement of the Phastite® fitting.

Gas testing

Gas testing was performed under pressure using nitrogen or helium gas at 1500 psi (100 bar). The purpose of the test is to ensure gas tight sealing is achieved followed by a high pressure hydro test at full cold working pressure. These tests have been carried out fully in accordance to ISO 19879 and externally witnessed.

Hyperbaric test

In addition to Phastite's ability to withstand internal pressures, Phastite® has been externally pressure tested to ensure sealability in external pressure applications. External pressure was applied with helium or nitrogen gas and water. At no point did leakage occur and in a number of cases the external pressure was adequate to collapse the tool without losing the Phastite® seal.

Deflection test

Phastite® was tested to prove its holding power by

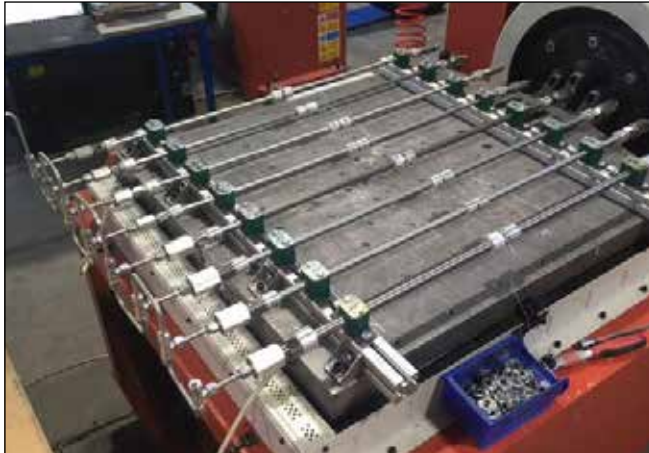

Vibration test

securing connectors at each end of two half-metre lengths of tubing joined by a Phastite® connector in the middle of the assembly. A load was applied to deflect the middle connector by a distance of 60mm (2.36") whilst pressurised at 2610 psi (180 bar) with no leakage experienced. This meets the customers' requirements however a more stringent test was also completed, deflecting the assembly by 300mm. Pressure was increased until tube burst was achieved. Once again proving the ability of the Phastite® product.

Vibration

Vibration tests have been carried out fully in accordance ASTM F1387. The test specimen is pressurised to a pre-determined pressure whilst being vibrated at its resonant frequency. No pressure loss or visible leakage is acceptable throughout the test.

Fire test (testing on 316 only)

The Phastite® product has been fully tested in accordance to BS.6755 pt 2. In this test the assembly is subjected to a fire scenario with temperatures in excess of 750°C (1382°F) for over 30 minutes. The test pieces are pressurised throughout the test period and are constantly examined for leakage / water loss. Phastite® past these test requirements with no visible leakage or water loss.

Tensile pull test

Tensile pull tests have been carried out fully in

accordance ASTM F1387. The Phastite® product has been subjected to a pull test where a Phastite® fitting is assembled between two tube lengths. These tube lengths are then mechanically pulled apart until failure, thus ensuring the resistive strength of Phastite®.

Thermo cycling

Thermo cycling tests have been carried out fully in accordance ASTM F1387. Phastite® tube assemblies have been subjected to thermo cycling from -65°C to +175°C (-85°F to 347°F), whilst pressurised with nitrogen gas. No pressure loss was acceptable throughout the test.



Thermo cycling test

Additional testing has also been carried out for CRA's and specific applications.

Permanent Union Equal Straight

PS

Permanent Union Equal Straight

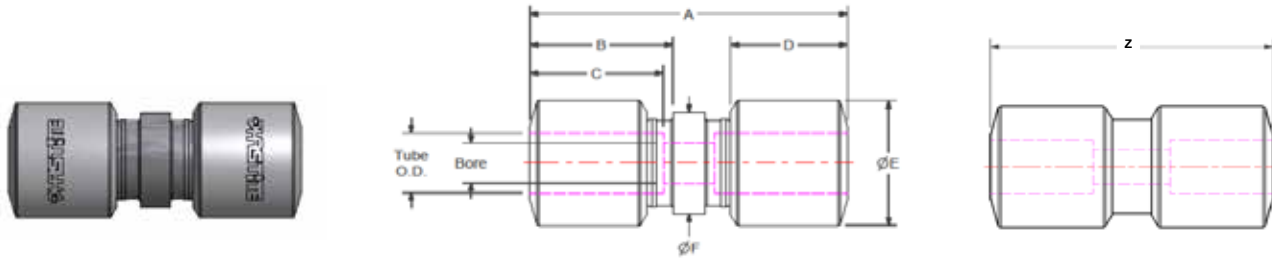

Imperial

Part No.	Tube O.D.	A	B	C	D	E	F	Bore	Z
PH-4-PS	1/4"	55.2 (2.17")	25.2 (0.99")	21.2 (0.83")	20.0 (0.79")	17.0 (0.67")	12.7 (0.50")	4.0 (0.16")	44.8 (1.76")
PH-6-PS	3/8"	58.6 (2.31")	25.9 (1.02")	22.7 (0.89")	21.0 (0.83")	22.0 (0.87")	17.0 (0.67")	6.0 (0.24")	48.8 (1.92")
PH-8-PS	1/2"	60.1 (2.37")	27.1 (1.07")	23.6 (0.93")	22.0 (0.87")	25.0 (0.98")	20.5 (0.81")	8.0 (0.31")	50.0 (1.97")
PH-10-PS	5/8"	70.2 (2.76")	29.9 (1.18")	26.1 (1.03")	25.0 (0.98")	32.0 (1.26")	25.0 (0.98")	12.0 (0.47")	60.5 (2.35")
PH-12-PS	3/4"	81.7 (3.21")	35.8 (1.41")	31.2 (1.23")	29.5 (1.16")	36.0 (1.42")	29.5 (1.16")	14.0 (0.55")	69.2 (2.72")
PH-16-PS	*1"	100.2 (3.94")	43.8 (1.72")	34.9 (1.37")	35.3 (1.39")	50.0 (1.97")	38.0 (1.50")	18.0 (0.71")	83.3 (3.28")

Metric

Part No.	Tube O.D.	A	B	C	D	E	F	Bore	Z
PH-M6-PS	6mm	55.2 (2.17")	25.2 (0.99")	21.2 (0.83")	20.0 (0.79")	17.0 (0.67")	12.7 (0.50")	4.0 (0.16")	44.8 (1.76")
PH-M10-PS	10mm	58.6 (2.31")	25.9 (1.02")	22.7 (0.89")	21.0 (0.83")	22.0 (0.87")	17.0 (0.67")	6.0 (0.24")	48.8 (1.92")
PH-M12-PS	12mm	60.1 (2.37")	27.1 (1.07")	23.6 (0.93")	22.0 (0.87")	25.0 (0.98")	20.5 (0.81")	8.0 (0.31")	50.0 (1.97")
PH-M16-PS	16mm	70.2 (2.76")	29.9 (1.18")	26.1 (1.03")	25.0 (0.98")	32.0 (1.26")	25.0 (0.98")	12.0 (0.47")	60.5 (2.35")
PH-M20-PS	20mm	81.7 (3.21")	35.8 (1.41")	31.2 (1.23")	29.5 (1.16")	36.0 (1.42")	29.5 (1.16")	14.0 (0.55")	69.2 (2.72")
PH-M25-PS	*25mm	100.2 (3.94")	43.8 (1.72")	34.9 (1.37")	35.3 (1.39")	50.0 (1.97")	38.0 (1.50")	18.0 (0.71")	83.3 (3.28")

Dimensions for reference only, subject to change.

To order, add material designator to part number above - Example PH-4-PS-SS

Material	Stainless Steel	INCONEL® Alloy 625	INCOLOY® Alloy 825	Super Duplex
Designator	SS	625	825	SD

*1" and 25mm only available in 316 Stainless Steel

Permanent Union Equal Elbow

PE

Permanent Union Equal Elbow

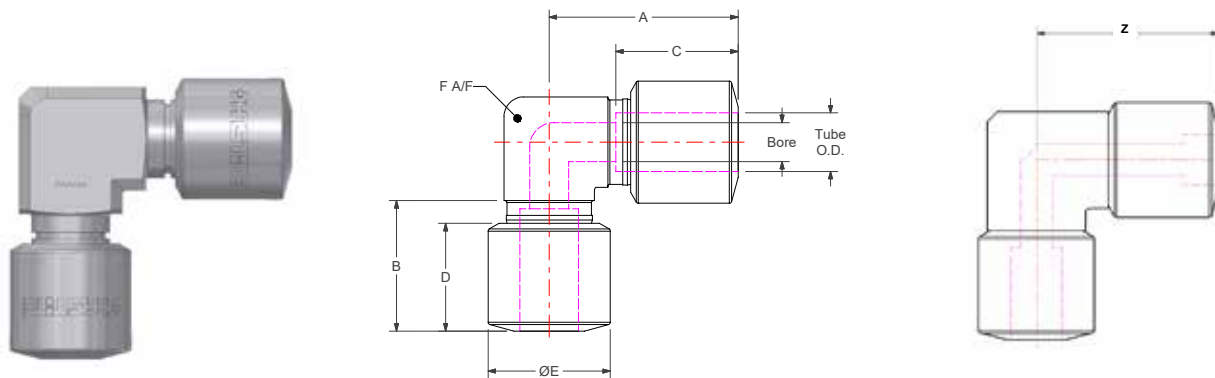

Imperial

Part No.	Tube O.D.	A	B	C	D	E	F	Bore	Z
PH-4-PE	1/4"	37.8 (1.49")	25.2 (0.99")	21.2 (0.83")	20.0 (0.79")	17.0 (0.67")	14.5 (0.57")	4.0 (0.16")	32.6 (1.28")
PH-6-PE	3/8"	39.5 (1.56")	25.9 (1.02")	22.7 (0.89")	21.0 (0.83")	22.0 (0.87")	14.5 (0.57")	6.0 (0.24")	34.6 (1.36")
PH-8-PE	1/2"	39.1 (1.54")	27.1 (1.07")	23.6 (0.93")	22.0 (0.87")	25.0 (0.98")	18.5 (0.73")	8.0 (0.31")	34.0 (1.34")
PH-10-PE	5/8"	46.8 (1.85")	29.9 (1.18")	26.1 (1.03")	25.0 (0.98")	32.0 (1.26")	22.5 (0.89")	12.0 (0.47")	41.9 (1.65")
PH-12-PE	3/4"	56.3 (2.22")	35.8 (1.41")	31.2 (1.23")	29.5 (1.16")	36.0 (1.42")	28.5 (1.12")	14.0 (0.55")	50.0 (1.97")
PH-16-PE	*1"	67.1 (2.64")	43.8 (1.72")	34.8 (1.37")	35.3 (1.39")	50.0 (1.97")	38.5 (1.52")	18.0 (0.71")	58.6 (2.31")

Metric

Part No.	Tube O.D.	A	B	C	D	E	F	Bore	Z
PH-M6-PE	6mm	37.8 (1.49")	25.2 (0.99")	21.2 (0.83")	20.0 (0.79")	17.0 (0.67")	14.5 (0.57")	4.0 (0.16")	32.6 (1.28")
PH-M10-PE	10mm	39.5 (1.56")	25.9 (1.02")	22.7 (0.89")	21.0 (0.83")	22.0 (0.87")	18.5 (0.73")	6.0 (0.24")	34.6 (1.36")
PH-M12-PE	12mm	39.1 (1.54")	27.1 (1.07")	23.6 (0.93")	22.0 (0.87")	25.0 (0.98")	18.5 (0.73")	8.0 (0.31")	34.0 (1.34")
PH-M16-PE	16mm	46.8 (1.85")	29.9 (1.18")	26.1 (1.03")	25.0 (0.98")	32.0 (1.26")	22.5 (0.89")	12.0 (0.47")	41.9 (1.65")
PH-M20-PE	20mm	56.3 (2.22")	35.8 (1.41")	31.2 (1.23")	29.5 (1.16")	36.0 (1.42")	28.5 (1.12")	14.0 (0.55")	50.0 (1.97")
PH-M25-PE	*25mm	67.1 (2.64")	43.8 (1.72")	34.8 (1.37")	35.3 (1.39")	50.0 (1.97")	38.5 (1.52")	18.0 (0.71")	58.6 (2.31")

Dimensions for reference only, subject to change.

To order, add material designator to part number above - Example PH-M10-PE-SS

Material	Stainless Steel	INCONEL® Alloy 625	INCOLOY® Alloy 825	Super Duplex
Designator	SS	625	825	SD

*1" and 25mm only available in 316 Stainless Steel

Permanent Union Equal Tee

PT

Permanent Union Equal Tee

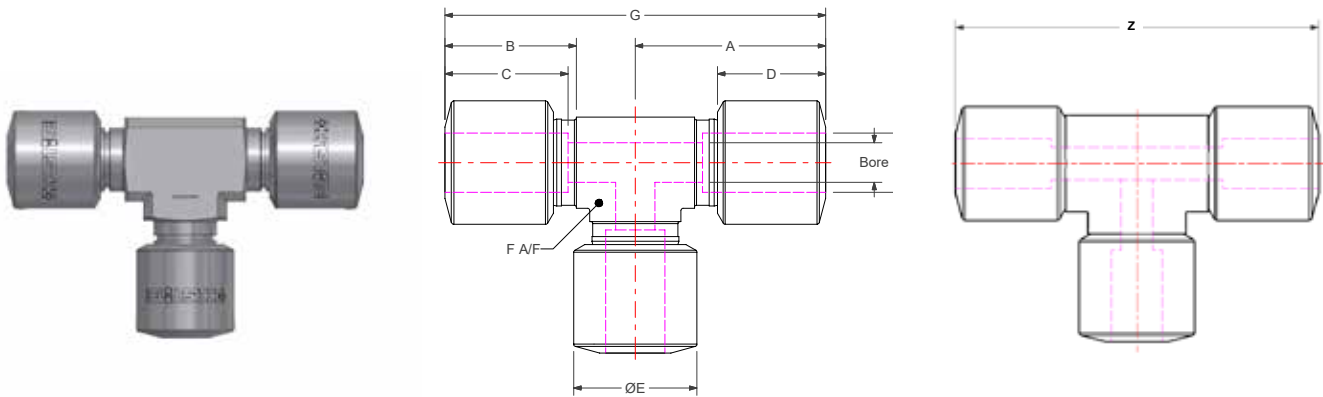

Imperial

Part No.	Tube O.D.	A	B	C	D	E	F	G	Bore	Z
PH-4-PT	1/4"	37.8 (1.49")	25.2 (0.99")	21.2 (0.83")	20.0 (0.79")	17.0 (0.67")	12.7 (0.50")	75.6 (2.98")	4.0 (0.16")	65.2 (2.57")
PH-6-PT	3/8"	39.5 (1.56")	25.9 (1.02")	22.7 (0.89")	21.0 (0.83")	22.0 (0.87")	19.0 (0.75")	79.0 (3.11")	6.0 (0.24")	69.2 (2.72")
PH-8-PT	1/2"	39.1 (1.54")	27.1 (1.07")	23.6 (0.93")	22.0 (0.87")	25.0 (0.98")	18.5 (0.73")	78.1 (3.07")	8.0 (0.31")	68.0 (2.68")
PH-10-PT	5/8"	46.8 (1.85")	29.9 (1.18")	26.1 (1.03")	25.0 (0.98")	32.0 (1.26")	23.8 (0.89")	93.6 (3.69")	12.0 (0.47")	84.5 (3.33")
PH-12-PT	3/4"	56.3 (2.22")	35.8 (1.41")	31.2 (1.23")	29.5 (1.16")	36.0 (1.42")	30.2 (1.19")	112.2 (4.43")	14.0 (0.55")	100.0 (3.94")
PH-16-PT	*1"	67.1 (2.64")	43.8 (1.72")	34.9 (1.37")	35.3 (1.39")	50.0 (1.97")	38.1 (1.50")	134.1 (5.28")	18.0 (0.71")	117.5 (4.62")

Metric

Part No.	Tube O.D.	A	B	C	D	E	F	G	Bore	Z
PH-M6-PT	6mm	37.8 (1.49")	25.2 (0.99")	21.2 (0.83")	20.0 (0.79")	17.0 (0.67")	12.7 (0.50")	75.6 (2.98")	4.0 (0.16")	65.2 (2.57")
PH-M10-PT	10mm	39.5 (1.56")	25.9 (1.02")	22.7 (0.89")	21.0 (0.83")	22.0 (0.87")	19.0 (0.75")	79.0 (3.11")	6.0 (0.24")	69.2 (2.72")
PH-M12-PT	12mm	39.1 (1.54")	27.1 (1.07")	23.6 (0.93")	22.0 (0.87")	25.0 (0.98")	18.5 (0.73")	78.1 (3.07")	8.0 (0.31")	68.0 (2.68")
PH-M16-PT	16mm	46.8 (1.85")	29.9 (1.18")	26.1 (1.03")	25.0 (0.98")	32.0 (1.26")	23.8 (0.89")	93.6 (3.69")	12.0 (0.47")	84.5 (3.33")
PH-M20-PT	20mm	56.3 (2.22")	35.8 (1.41")	31.2 (1.23")	29.5 (1.16")	36.0 (1.42")	30.2 (1.19")	112.2 (4.43")	14.0 (0.55")	100.0 (3.94")
PH-M25-PT	*25mm	67.1 (2.64")	43.8 (1.72")	34.9 (1.37")	35.3 (1.39")	50.0 (1.97")	38.1 (1.50")	134.1 (5.28")	18.0 (0.71")	117.5 (4.62")

Dimensions for reference only, subject to change.

To order, add material designator to part number above - Example PH-6-PT-625

Material	Stainless Steel	INCONEL® Alloy 625	INCOLOY® Alloy 825	Super Duplex
Designator	SS	625	825	SD

*1" and 25mm only available in 316 Stainless Steel

Permanent Union Equal Cross

PC

Permanent Union Equal Cross

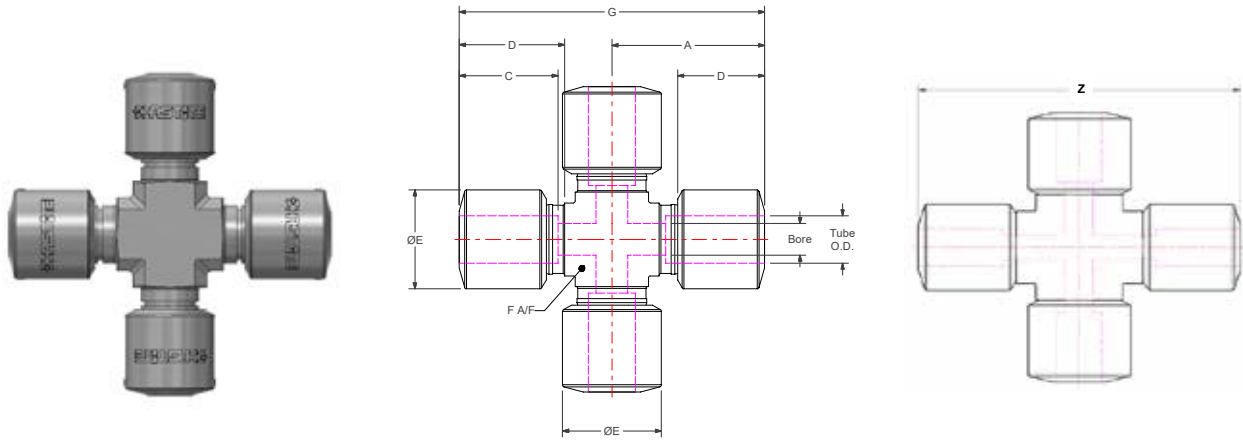

Imperial

Part No.	Tube O.D.	A	B	C	D	E	F	G	Bore	Z
PH-4-PC	1/4"	37.2 (1.47")	25.2 (0.99")	20.9 (0.82")	19.0 (0.75")	17.0 (0.67")	14.5 (0.57")	74.5 (2.93")	4.0 (0.16")	65.2 (2.57")
PH-6-PC	3/8"	39.2 (1.54")	25.9 (1.02")	22.9 (0.90")	21.0 (0.83")	22.0 (0.87")	14.5 (0.57")	78.5 (3.09")	6.0 (0.24")	69.2 (2.72")
PH-8-PC	1/2"	38.6 (1.52")	27.1 (1.07")	23.6 (0.93")	22.0 (0.87")	25.0 (0.98")	18.5 (0.73")	77.3 (3.04")	8.0 (0.31")	68.0 (2.68")
PH-10-PC	5/8"	45.9 (1.81")	29.9 (1.18")	25.9 (1.02")	25.0 (0.98")	32.0 (1.26")	22.5 (0.89")	91.8 (3.61")	12.0 (0.47")	84.5 (3.33")

Metric

Part No.	Tube O.D.	A	B	C	D	E	F	G	Bore	Z
PH-M6-PC	6mm	37.2 (1.47")	25.2 (0.99")	20.9 (0.82")	19.0 (0.75")	17.0 (0.67")	14.5 (0.57")	74.5 (2.93")	4.0 (0.16")	65.2 (2.57")
PH-M10-PC	10mm	39.2 (1.54")	25.9 (1.02")	22.9 (0.90")	21.0 (0.83")	22.0 (0.87")	14.5 (0.57")	78.5 (3.09")	6.0 (0.24")	69.2 (2.72")
PH-M12-PC	12mm	38.6 (1.52")	27.1 (1.07")	23.6 (0.93")	22.0 (0.87")	25.0 (0.98")	18.5 (0.73")	77.3 (3.04")	8.0 (0.31")	68.0 (2.68")
PH-M16-PC	16mm	45.9 (1.81")	29.9 (1.18")	25.9 (1.02")	25.0 (0.98")	32.0 (1.26")	22.5 (0.89")	91.8 (3.61")	12.0 (0.47")	84.5 (3.33")

Dimensions for reference only, subject to change.

To order, add material designator to part number above - *Example PH-M12-PC-SS*

Material	Stainless Steel	INCONEL® Alloy 625	INCOLOY® Alloy 825	Super Duplex
Designator	SS	625	825	SD

Permanent Union Drop Size Straight

PS

Permanent Union Drop Size Straight

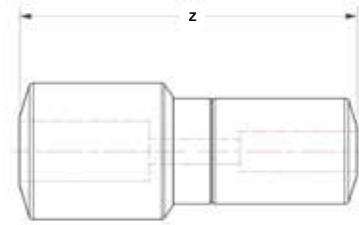
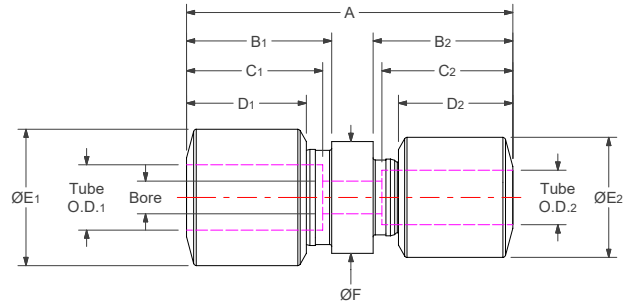
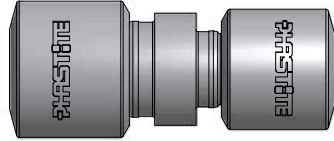

Imperial

Part No.	A	Tube O.D.1	B1	C1	D1	E1	Tube O.D.2	B2	C2	D2	E2	F2	Bore	Z
PH-6-4-PS	56.3 (2.22")	3/8"	25.9 (1.02")	22.7 (0.89")	21.0 (0.83")	22.0 (0.87")	1/4"	25.2 (0.99")	21.2 (0.83")	20.0 (0.79")	17.0 (0.67")	17.0 (0.67")	4.0 (0.16")	46.2 (1.82")
PH-8-6-PS	58.8 (2.31")	1/2"	26.7 (1.05")	23.6 (0.93")	22.0 (0.87")	25.0 (0.98")	3/8"	25.7 (1.01")	22.9 (0.90")	21.0 (0.83")	22.0 (0.87")	20.5 (0.81")	6.0 (0.24")	49.4 (1.85")
PH-10-8-PS	74.7 (2.94")	5/8"	29.9 (1.18")	26.1 (1.03")	25.0 (0.98")	32.0 (1.26")	1/2"	27.1 (1.07")	23.6 (0.93")	22.0 (0.87")	25.0 (0.98")	25.0 (0.98")	8.0 (0.31")	65.4 (2.58")
PH-12-10-PS	82.5 (3.25")	3/4"	35.6 (1.40")	31.2 (1.23")	29.5 (1.16")	36.0 (1.42")	5/8"	29.7 (1.17")	25.9 (1.02")	25.0 (0.98")	32.0 (1.26")	29.5 (1.16")	12.0 (0.47")	71.7 (2.83")
PH-16-12-PS	93.0 (3.66")	*1"	40.3 (1.59")	34.8 (1.37")	33.5 (1.32")	50.0 (1.97")	3/4"	37.6 (1.48")	32.4 (1.28")	31.0 (1.22")	43.0 (1.69")	38.0 (1.50")	16.0 (0.63")	79.6 (3.14")

Metric

Part No.	A	Tube O.D.1	B1	C1	D1	E1	Tube O.D.2	B2	C2	D2	E2	F2	Bore	z
PH-M10-M6-PS	56.3 (2.22")	10mm	25.9 (1.02")	22.7 (0.89")	21.0 (0.83")	22.0 (0.87")	8mm	25.2 (0.99")	21.2 (0.83")	20.0 (0.79")	17.0 (0.67")	17.0 (0.67")	4.0 (0.16")	46.2 (1.82")
PH-M12-M10-PS	58.1 (2.29")	12mm	26.7 (1.05")	23.6 (0.93")	22.0 (0.87")	25.0 (0.98")	10mm	25.7 (1.01")	22.9 (0.90")	21.0 (0.83")	22.0 (0.87")	20.5 (0.81")	6.0 (0.24")	49.4 (1.85")
PH-M16-M12-PS	65.4 (2.58")	16mm	29.9 (1.18")	26.1 (1.03")	25.0 (0.98")	32.0 (1.26")	14mm	27.1 (1.07")	23.6 (0.93")	22.0 (0.87")	25.0 (0.98")	25.0 (0.98")	8.0 (0.31")	65.4 (2.58")
PH-M20-M16-PS	74.8 (2.94")	20mm	35.6 (1.40")	31.2 (1.23")	29.5 (1.16")	36.0 (1.42")	18mm	29.7 (1.17")	25.9 (1.02")	25.0 (0.98")	32.0 (1.26")	29.5 (1.16")	12.0 (0.47")	71.7 (2.83")
PH-M25-M20-PS	83.8 (3.30")	*25mm	40.3 (1.59")	34.8 (1.37")	33.5 (1.32")	50.0 (1.97")	22mm	37.6 (1.48")	32.4 (1.28")	31.0 (1.22")	43.0 (1.69")	38.0 (1.50")	16.0 (0.63")	79.6 (3.14")

Dimensions for reference only, subject to change.

To order, add material designator to part number above - Example PH-4-PS-SS

Material	Stainless Steel	INCONEL® Alloy 625	INCOLOY® Alloy 825	Super Duplex
Designator	SS	625	825	SD

*1" and 25mm only available in 316 Stainless Steel

Termination Male Straight - NPT

TMS - N Termination Male Straight - NPT

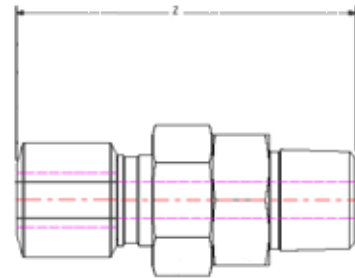
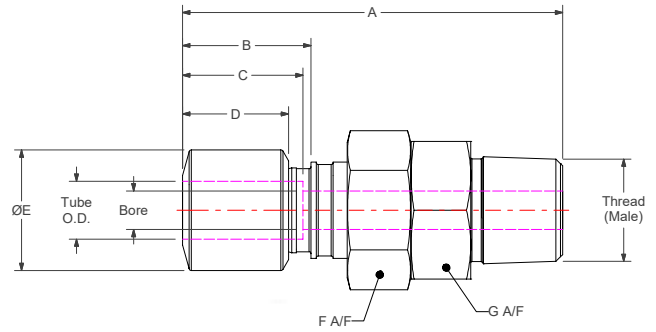
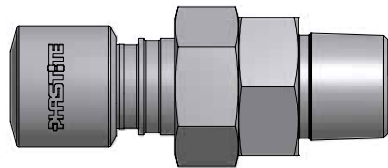

Imperial

Part No.	Tube O.D.	A	B	C	D	E	F	G	Bore	Thread	Z
PH-4-4N-TMS	1/4"	67.1 (2.64")	23.7 (0.93")	20.9 (0.82")	19.0 (0.75")	17.0 (0.67")	20.6 (0.81")	19.0 (0.75")	4.0 (0.16")	1/4-18 NPT	62.4 (2.46")
PH-6-4N-TMS	3/8"	69.6 (2.74")	25.7 (1.01")	22.9 (0.90")	21.0 (0.83")	22.0 (0.87")	25.4 (1.00")	25.4 (1.00")	6.0 (0.24")	1/4-18 NPT	65.9 (2.59")
PH-6-6N-TMS	3/8"	69.6 (2.74")	25.7 (1.01")	22.9 (0.90")	21.0 (0.83")	22.0 (0.87")	25.4 (1.00")	25.4 (1.00")	6.0 (0.24")	3/8-18 NPT	65.9 (2.59")
PH-8-8N-TMS	1/2"	77.6 (3.06")	26.7 (1.05")	23.6 (0.93")	22.0 (0.87")	25.0 (0.98")	28.6 (1.13")	28.6 (1.13")	8.0 (0.31")	1/2-14 NPT	75.9 (2.99")
PH-10-12N-TMS	5/8"	84.6 (3.33")	29.7 (1.17")	25.9 (1.02")	25.0 (0.98")	32.0 (1.26")	34.9 (1.37")	34.9 (1.37")	12.0 (0.47")	3/4-14 NPT	86.9 (3.42")
PH-12-12N-TMS	3/4"	90.6 (3.57")	35.6 (1.40")	31.2 (1.23")	29.5 (1.16")	36.0 (1.42")	38.1 (1.50")	38.1 (1.50")	14.0 (0.55")	3/4-14 NPT	91.0 (3.58")
PH-16-16N-TMS	*1"	100.3 (3.95")	40.3 (1.59")	34.8 (1.37")	33.5 (1.32")	50.0 (1.97")	50.8 (2.00")	47.6 (1.87")	18.0 (0.71")	1-11.5 NPT	109.7 (4.32")

Metric

Part No.	Tube O.D.	A	B	C	D	E	F	G	Bore	Thread	Z
PH-M6-4N-TMS	6mm	67.4 (2.65")	23.7 (0.93")	20.9 (0.82")	19.0 (0.75")	17.0 (0.67")	20.6 (0.81")	19.0 (0.75")	4.0 (0.16")	1/4-18 NPT	62.4 (2.46")
PH-M10-4N-TMS	10mm	69.6 (2.74")	25.7 (1.01")	22.9 (0.90")	21.0 (0.83")	22.0 (0.87")	25.4 (1.00")	25.4 (1.00")	6.0 (0.24")	1/4-18 NPT	65.9 (2.59")
PH-M10-6N-TMS	10mm	69.6 (2.74")	25.7 (1.01")	22.9 (0.90")	21.0 (0.83")	22.0 (0.87")	25.4 (1.00")	25.4 (1.00")	6.0 (0.24")	3/8-18 NPT	65.9 (2.59")
PH-M12-8N-TMS	12mm	77.7 (3.06")	26.7 (1.05")	23.6 (0.93")	22.0 (0.87")	25.0 (0.98")	28.6 (1.13")	28.6 (1.13")	8.0 (0.31")	1/2-14 NPT	75.9 (2.99")
PH-M16-12N-TMS	16mm	84.6 (3.33")	29.7 (1.17")	25.9 (1.02")	25.0 (0.98")	32.0 (1.26")	34.9 (1.37")	34.9 (1.37")	12.0 (0.47")	3/4-14 NPT	86.9 (3.42")
PH-M20-12N-TMS	20mm	90.6 (3.57")	35.6 (1.40")	31.2 (1.23")	29.5 (1.16")	36.0 (1.42")	38.1 (1.50")	38.1 (1.50")	14.0 (0.55")	3/4-14 NPT	91.0 (3.58")
PH-M25-16N-TMS	*25mm	100.3 (3.95")	40.3 (1.59")	34.8 (1.37")	33.5 (1.32")	50.0 (1.97")	50.8 (2.00")	47.6 (1.87")	18.0 (0.71")	1-11.5 NPT	109.7 (4.32")

Dimensions for reference only, subject to change.

To order, add material designator to part number above - *Example PH-M12-8N-TMS-SS*

Material	Stainless Steel	INCONEL® Alloy 625	INCOLOY® Alloy 825	Super Duplex
Designator	SS	625	825	SD

*1" and 25mm only available in 316 Stainless Steel

Note: Termination connectors can only be assembled using the Tri-Tool

Termination Female Straight - NPT

TFS - N

Termination Female Straight - NPT

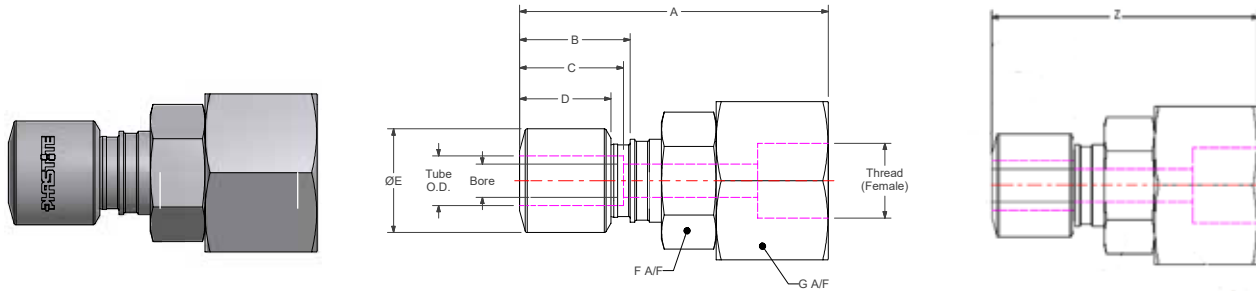

Imperial

Part No.	Tube O.D.	A	B	C	D	E	F	G	Bore	Thread	Z
PH-4-4N-TFS	1/4"	68.1 (2.68")	23.7 (0.93")	20.9 (0.82")	19.0 (0.75")	17.0 (0.67")	20.6 (0.81")	28.6 (1.13")	4.0 (0.16")	1/4-18 NPT	63.4 (2.50")
PH-6-4N-TFS	3/8"	70.6 (2.78")	25.7 (1.01")	22.9 (0.90")	21.0 (0.83")	22.0 (0.87")	25.4 (1.00")	25.4 (1.00")	6.0 (0.24")	1/4-18 NPT	66.9 (2.63")
PH-6-6N-TFS	3/8"	72.1 (2.84")	25.7 (1.01")	22.9 (0.90")	21.0 (0.83")	22.0 (0.87")	25.4 (1.00")	25.4 (1.00")	6.0 (0.24")	3/8-18 NPT	68.4 (2.69")
PH-8-8N-TFS	1/2"	77.6 (3.06")	26.7 (1.05")	23.6 (0.93")	22.0 (0.87")	25.0 (0.98")	28.6 (1.13")	38.1 (1.50")	8.0 (0.31")	1/2-14 NPT	75.9 (2.99")
PH-10-12N-TFS	5/8"	80.6 (3.18")	29.7 (1.17")	25.9 (1.02")	25.0 (0.98")	32.0 (1.26")	34.9 (1.37")	38.1 (1.50")	12.0 (0.47")	3/4-14 NPT	82.9 (3.26")
PH-12-12N-TFS	3/4"	86.6 (3.41")	35.6 (1.40")	31.2 (1.23")	29.5 (1.16")	36.0 (1.42")	38.1 (1.50")	38.1 (1.50")	14.0 (0.55")	3/4-14 NPT	87.0 (3.43")
PH-16-16N-TFS	*1"	95.3 (3.75")	40.3 (1.59")	34.8 (1.37")	33.5 (1.32")	50.0 (1.97")	50.8 (2.00")	47.6 (1.87")	18.0 (0.71")	1-11.5 NPT	105.0 (4.13")

Metric

Part No.	Tube O.D.	A	B	C	D	E	F	G	Bore	Thread	Z
PH-M6-4N-TFS	6mm	68.4 (2.69")	23.7 (0.93")	20.9 (0.82")	19.0 (0.75")	17.0 (0.67")	20.6 (0.81")	28.6 (1.13")	4.0 (0.16")	1/4-18 NPT	63.4 (2.50")
PH-M10-4N-TFS	10mm	70.6 (2.78")	25.7 (1.01")	22.9 (0.90")	21.0 (0.83")	22.0 (0.87")	25.4 (1.00")	25.4 (1.00")	6.0 (0.24")	1/4-18 NPT	66.9 (2.63")
PH-M10-6N-TFS	10mm	72.1 (2.84")	25.7 (1.01")	22.9 (0.90")	21.0 (0.83")	22.0 (0.87")	25.4 (1.00")	25.4 (1.00")	6.0 (0.24")	3/8-18 NPT	68.4 (2.69")
PH-M12-8N-TFS	12mm	77.7 (3.06")	26.7 (1.05")	23.1 (0.91")	22.0 (0.87")	25.0 (0.98")	28.6 (1.13")	38.1 (1.50")	8.0 (0.31")	1/2-14 NPT	75.9 (2.99")
PH-M16-12N-TFS	16mm	80.6 (3.18")	29.7 (1.17")	25.9 (1.02")	25.0 (0.98")	32.0 (1.26")	34.9 (1.37")	38.1 (1.50")	12.0 (0.47")	3/4-14 NPT	82.9 (3.26")
PH-M20-12N-TFS	20mm	86.6 (3.41")	35.6 (1.40")	31.0 (1.22")	29.5 (1.16")	36.0 (1.42")	38.1 (1.50")	38.1 (1.50")	14.0 (0.55")	3/4-14 NPT	87.0 (3.43")
PH-M25-16N-TFS	*25mm	95.3 (3.75")	40.3 (1.59")	34.8 (1.37")	33.5 (1.32")	50.0 (1.97")	50.8 (2.00")	47.6 (1.87")	18.0 (0.71")	1-11.5 NPT	105.0 (4.13")

Dimensions for reference only, subject to change.

To order, add material designator to part number above - Example PH-4-4N-TFS-825

Material	Stainless Steel	INCONEL® Alloy 625	INCOLOY® Alloy 825	Super Duplex
Designator	SS	625	825	SD

*1" and 25mm only available in 316 Stainless Steel

Note: Termination connectors can only be assembled using the Tri-Tool®

Termination Male Straight - BSPP

TMS - R Termination Male Straight - BSPP

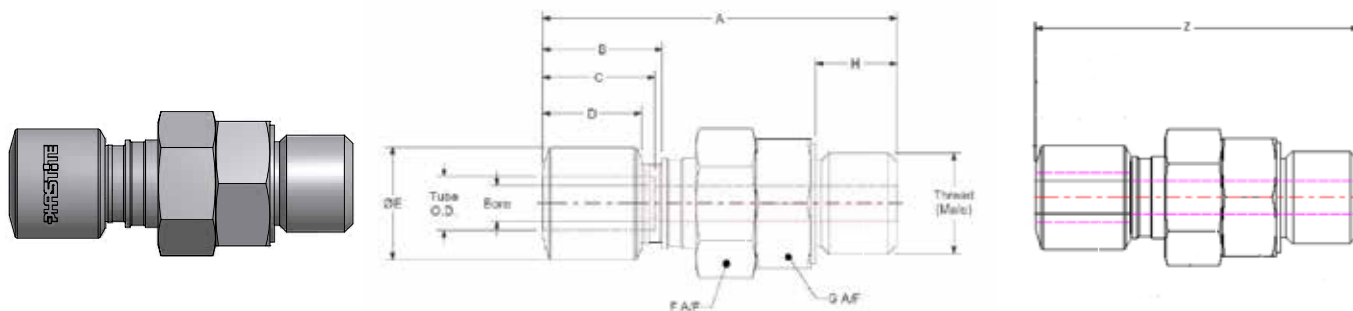

Imperial

Part No.	Tube O.D.	A	B	C	D	E	F	G	Bore	Thread	Z	H
PH-4-4R-TMS	1/4"	67.1 (2.64")	23.7 (0.93")	20.9 (0.82")	19.0 (0.75")	17.0 (0.67")	20.6 (0.81")	19.0 (0.75")	4.0 (0.16")	1/4-19 BSPP	62.4 (2.46")	12.0 (0.47")
PH-6-4R-TMS	3/8"	69.6 (2.74")	25.7 (1.01")	22.9 (0.90")	21.0 (0.83")	22.0 (0.87")	25.4 (1.00")	25.4 (1.00")	6.0 (0.24")	1/4-19 BSPP	65.9 (2.59")	12.0 (0.47")
PH-6-6R-TMS	3/8"	69.6 (2.74")	25.7 (1.01")	22.9 (0.90")	21.0 (0.83")	22.0 (0.87")	25.4 (1.00")	25.4 (1.00")	6.0 (0.24")	3/8-19 BSPP	65.9 (2.59")	12.0 (0.47")
PH-8-8R-TMS	1/2"	77.6 (3.06")	26.7 (1.05")	23.6 (0.93")	22.0 (0.87")	25.0 (0.98")	28.6 (1.13")	28.6 (1.13")	8.0 (0.31")	1/2-14 BSPP	75.9 (2.99")	14.0 (0.55")
PH-10-12R-TMS	5/8"	84.6 (3.33")	29.7 (1.17")	25.9 (1.02")	25.0 (0.98")	32.0 (1.26")	34.9 (1.37")	34.9 (1.37")	12.0 (0.47")	3/4-14 BSPP	86.9 (3.42")	16.0 (0.63")
PH-12-12R-TMS	3/4"	90.6 (3.57")	35.6 (1.40")	31.2 (1.23")	29.5 (1.16")	36.0 (1.42")	38.1 (1.50")	38.1 (1.50")	14.0 (0.55")	3/4-14 BSPP	91.0 (3.58")	16.0 (0.63")
PH-16-16R-TMS	*1"	100.3 (3.95")	40.3 (1.59")	34.8 (1.37")	33.5 (1.32")	50.0 (1.97")	50.8 (2.00")	47.6 (1.87")	18.0 (0.71")	1-11.5 BSPP	109.7 (4.32")	18.0 (0.71")

Metric

Part No.	Tube O.D.	A	B	C	D	E	F	G	Bore	Thread	Z	H
PH-M6-4R-TMS	6mm	67.4 (2.65")	23.7 (0.93")	20.9 (0.82")	19.0 (0.75")	17.0 (0.67")	20.6 (0.81")	19.0 (0.75")	4.0 (0.16")	1/4-19 BSPP	62.4 (2.46")	12.0 (0.47")
PH-M10-4R-TMS	10mm	69.6 (2.74")	25.7 (1.01")	22.9 (0.90")	21.0 (0.83")	22.0 (0.87")	25.4 (1.00")	25.4 (1.00")	6.0 (0.24")	1/4-19 BSPP	65.9 (2.59")	12.0 (0.47")
PH-M10-6R-TMS	10mm	69.6 (2.74")	25.7 (1.01")	22.9 (0.90")	21.0 (0.83")	22.0 (0.87")	25.4 (1.00")	25.4 (1.00")	8.0 (0.31")	3/8-19 BSPP	65.9 (2.59")	12.0 (0.47")
PH-M12-8R-TMS	12mm	77.7 (3.06")	26.7 (1.05")	23.1 (0.91")	22.0 (0.87")	25.0 (0.98")	28.6 (1.13")	28.6 (1.13")	8.0 (0.31")	1/2-14 BSPP	75.9 (2.99")	14.0 (0.55")
PH-M16-12R-TMS	16mm	84.6 (3.33")	29.7 (1.17")	25.9 (1.02")	25.0 (0.98")	32.0 (1.26")	34.9 (1.37")	34.9 (1.37")	12.0 (0.47")	3/4-14 BSPP	86.9 (3.42")	16.0 (0.63")
PH-M20-12R-TMS	20mm	90.6 (3.57")	35.6 (1.40")	31.0 (1.22")	29.5 (1.16")	36.0 (1.42")	38.1 (1.50")	38.1 (1.50")	14.0 (0.55")	3/4-14 BSPP	91.0 (3.58")	16.0 (0.63")
PH-M25-16R-TMS	*25mm	100.3 (3.95")	40.3 (1.59")	34.8 (1.37")	33.5 (1.32")	50.0 (1.97")	50.8 (2.00")	47.6 (1.87")	18.0 (0.71")	1-11 BSPP	109.7 (4.32")	18.0 (0.71")

Dimensions for reference only, subject to change.

To order, add material designator to part number above - Example PH-M10-6R-TMS-SD

Material	Stainless Steel	INCONEL® Alloy 625	INCOLOY® Alloy 825	Super Duplex
Designator	SS	625	825	SD

*1" and 25mm only available in 316 Stainless Steel

Note: Termination connectors can only be assembled using the Tri-Tool

Termination Female Straight - BSPP

TFS - R

Termination Female Straight - BSPP

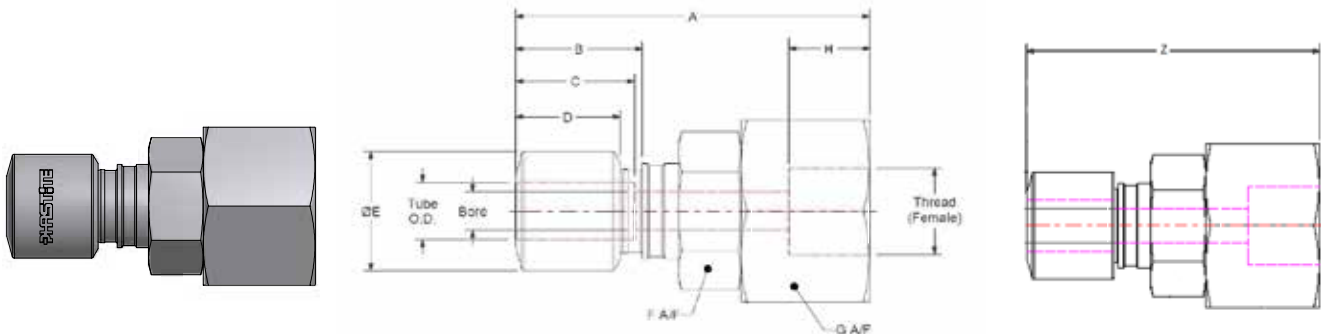

Imperial

Part No.	Tube O.D.	A	B	C	D	E	F	G	Bore	Thread	Z	H
PH-4-4R-TFS	1/4"	70.1 (2.76")	23.7 (0.93")	20.9 (0.82")	19.0 (0.75")	17.0 (0.67")	20.6 (0.81")	28.6 (1.13")	4.0 (0.16")	1/4-19 BSPP	65.4 (2.57")	15.0 (0.59")
PH-6-4R-TFS	3/8"	72.6 (2.86")	25.7 (1.01")	22.9 (0.90")	21.0 (0.83")	22.0 (0.87")	25.4 (1.00")	25.4 (1.00")	6.0 (0.24")	1/4-19 BSPP	68.9 (2.71")	15.0 (0.59")
PH-6-6R-TFS	3/8"	74.1 (2.92")	25.7 (1.01")	22.9 (0.90")	21.0 (0.83")	22.0 (0.87")	25.4 (1.00")	25.4 (1.00")	6.0 (0.24")	3/8-19 BSPP	70.4 (2.77")	15.0 (0.59")
PH-8-8R-TFS	1/2"	78.6 (3.10")	26.7 (1.05")	23.6 (0.93")	22.0 (0.87")	25.0 (0.98")	28.6 (1.13")	38.1 (1.50")	8.0 (0.31")	1/2-14 BSPP	76.9 (3.03")	18.0 (0.71")
PH-10-12R-TFS	5/8"	83.1 (3.27")	29.7 (1.17")	25.9 (1.02")	25.0 (0.98")	32.0 (1.26")	34.9 (1.37")	38.1 (1.50")	12.0 (0.47")	3/4-14 BSPP	85.4 (3.36")	20.0 (0.79")
PH-12-12R-TFS	3/4"	89.1 (3.51")	35.6 (1.40")	31.2 (1.23")	29.5 (1.16")	36.0 (1.42")	38.1 (1.50")	38.1 (1.50")	14.0 (0.55")	3/4-14 BSPP	89.5 (3.52")	20.0 (0.79")
PH-16-16R-TFS	*1"	96.3 (3.79")	40.3 (1.59")	34.8 (1.37")	33.5 (1.32")	50.0 (1.97")	50.8 (2.00")	47.6 (1.87")	18.0 (0.71")	1-11.5 BSPP	106.0 (4.17")	22.0 (0.87")

Metric

Part No.	Tube O.D.	A	B	C	D	E	F	G	Bore	Thread	Z	H
PH-M6-4R-TFS	6mm	70.4 (2.77")	23.7 (0.93")	20.9 (0.82")	19.0 (0.75")	17.0 (0.67")	20.6 (0.81")	28.6 (1.13")	4.0 (0.16")	1/4-19 BSPP	65.4 (2.57")	15.0 (0.59")
PH-M10-4R-TFS	10mm	72.6 (2.86")	25.7 (1.01")	22.9 (0.90")	21.0 (0.83")	22.0 (0.87")	25.4 (1.00")	25.4 (1.00")	6.0 (0.24")	1/4-19 BSPP	68.9 (2.71")	15.0 (0.59")
PH-M10-6R-TFS	10mm	74.1 (2.92")	25.7 (1.01")	22.9 (0.90")	21.0 (0.83")	22.0 (0.87")	25.4 (1.00")	25.4 (1.00")	8.0 (0.31")	3/8-19 BSPP	70.4 (2.77")	15.0 (0.59")
PH-M12-8R-TFS	12mm	78.7 (3.10")	26.7 (1.05")	23.1 (0.91")	22.0 (0.87")	25.0 (0.98")	28.6 (1.13")	38.1 (1.50")	8.0 (0.31")	1/2-14 BSPP	76.9 (3.03")	18.0 (0.71")
PH-M16-12R-TFS	16mm	83.1 (3.27")	29.7 (1.17")	25.9 (1.02")	25.0 (0.98")	32.0 (1.26")	34.9 (1.37")	38.1 (1.50")	12.0 (0.47")	3/4-14 BSPP	85.4 (3.36")	20.0 (0.79")
PH-M20-12R-TFS	20mm	89.1 (3.51")	35.6 (1.40")	31.0 (1.22")	29.5 (1.16")	36.0 (1.42")	38.1 (1.50")	38.1 (1.50")	14.0 (0.55")	3/4-14 BSPP	89.5 (3.52")	20.0 (0.79")
PH-M25-16R-TFS	*25mm	96.3 (3.79")	40.3 (1.59")	34.8 (1.37")	33.5 (1.32")	50.0 (1.97")	50.8 (2.00")	47.6 (1.87")	18.0 (0.71")	1-11 BSPP	106.0 (4.17")	22.0 (0.87")

Dimensions for reference only, subject to change.

To order, add material designator to part number above - Example PH-4-4R-TFS-625

Material	Stainless Steel	INCONEL® Alloy 625	INCOLOY® Alloy 825	Super Duplex
Designator	SS	625	825	SD

*1" and 25mm only available in 316 Stainless Steel

Note: Termination connectors can only be assembled using the Tri-Tool

Assembly Tools

Phastite® Tooling

Phastite's unique design provides a secure leak tight grip on the tubing. The connector make-up is completed using either a hand held tool or a bench mounted tool. The tools have built-in hydraulic cylinders actuated by a pump. The pumps can be driven pneumatically, electrically or manually. Please see Bulletin 5909 for tooling details and installation instructions. Servicing is required following 5,000, 10,000, 20,000 and 30,000 cycles.

Phastool® 3A Hand Held Tool

For 1/4" (6mm), 3/8"(10mm) connections

For the smallest sizes of Phastite® a compact portable tool is available for ease of installation in confined spaces. The portable tool is supplied complete with a 12 ft (4 metre) hose and quick connectors. The unit is also supplied complete with hose guards and grips at both ends providing extra safety, vice mounts and all required inserts for assembling.

Part No: PH-3A-TOOL-BP
PH-3A-TOOL-HP

Note: BP denotes a battery operated hydraulic pump and HP denotes a hand operated hydraulic pump.

Weight: 13lbs (6kg)

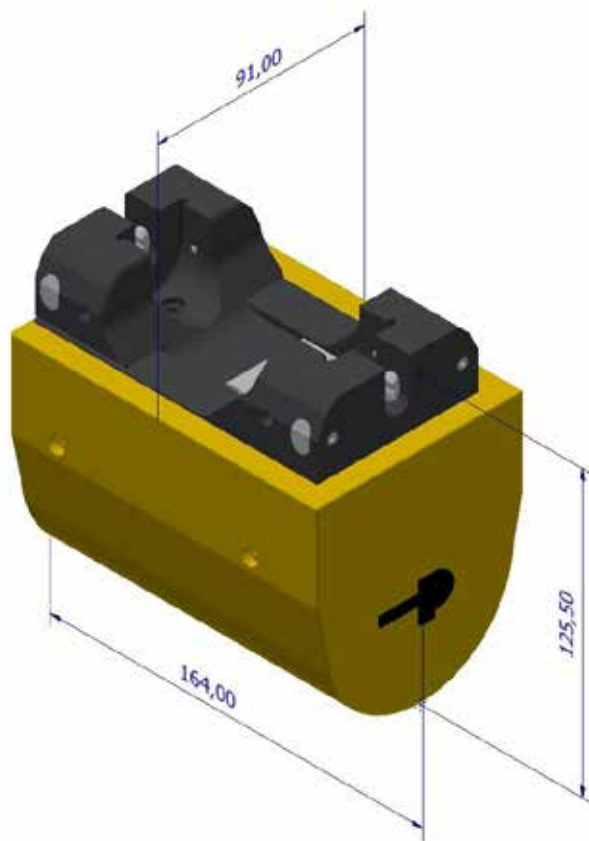

Basic dimensions of this tool are included for planning installations. For installation instructions, please view bulletin 5909. However for installation with limited access, it is advised to consult the factory for more information regarding jaw movement and access requirements.

Tube Clearance for Phastool® 3A

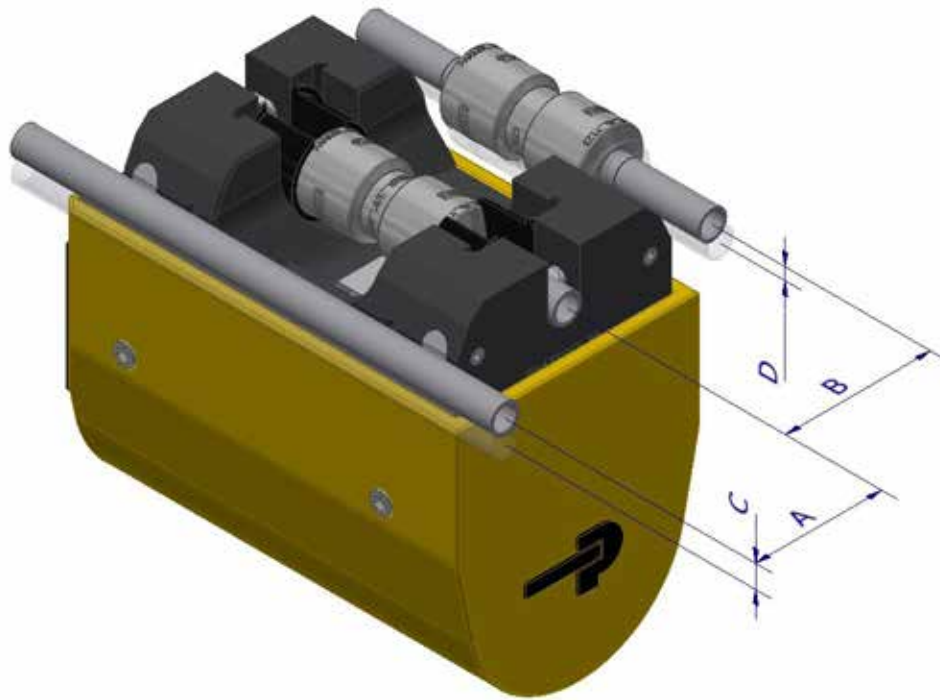

Tube / Fitting Size			A	B	C	D
Size	Imperial	Metric				
4	1/4"	6mm	40.2 (1.625")	45.5 (1.8125")	8.8 (0.375")	3.5 (0.125")
6	3/8"	10mm	41.8 (1.75")	48 (1.89")	7.5 (0.29")	4 (0.16")
8	1/2"	12mm	43.4 (1.75")	49.5 (2")	6.5 (0.25")	3.3 (0.125")
10	5/8"	16mm	44.9 (1.75")	53 (2.5")	5.6 (0.25")	1.8 (0.0625")
12	3/4"	20mm	46.5 (1.875")	55 (2.1875")	4.7 (0.1875")	1 (0.0625")
16	1"	25mm	49.7 (2")	63 (2.5")	3.2 (0.125")	0 (0")

- A - Minimum gap between Phastool® centreline and tube run centreline.
- B - Minimum gap between Phastool® centreline and Phastite® centreline.
- C - Maximum height between Phastool® centreline and tube run centreline.
- D - Maximum height between Phastool® centreline and Phastite® centreline.

Assembly Tools

Phastool® 3B

For 1/4" (6mm), 3/8" (10mm), 1/2" (12mm),
5/8" (16mm) connections

For medium sizes of Phastite® a larger portable tool is available for ease of installation. The portable tool is supplied complete with a 12 ft (4 metre) hose and quick connectors. The unit is also supplied complete with hose guards and grips at both ends providing extra safety, vice mounts and all required inserts for assembling 1/4" [6mm], 3/8" [10mm], 1/2" [12mm] and 5/8" [16mm] permanent Phastite® connectors.

Part No: PH-3B-TOOL-BP
PH-3B-TOOL-HP

Note: BP denotes a battery operated hydraulic pump and HP denotes a manually operated hydraulic pump.

Weight: 22 lbs. (9.5 Kg)

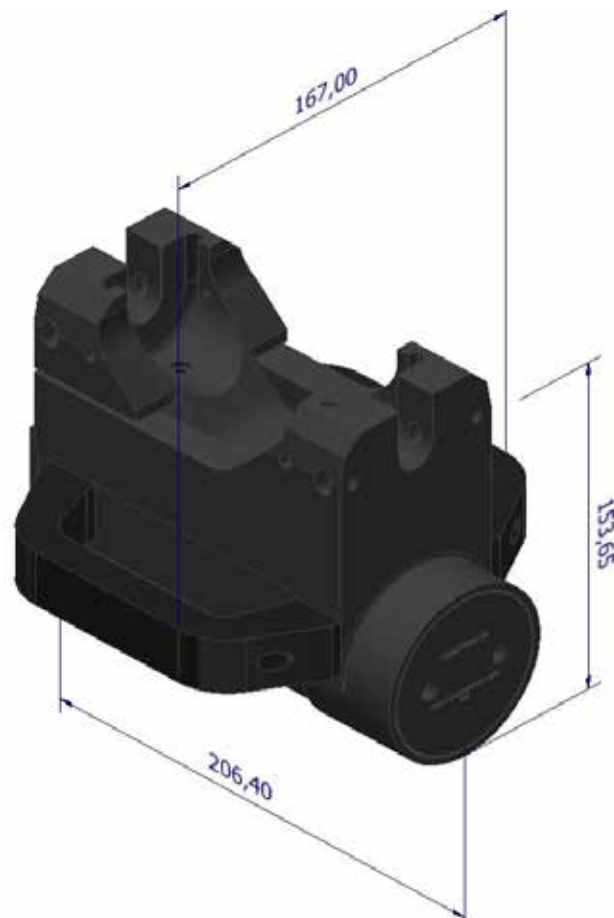

Basic dimensions of this tool are included for planning installations. For installation instructions, please view bulletin 5909. However for installation with limited access, it is advised to consult the factory for more information regarding jaw movement and access requirements.

Tube Clearance for Phastool® 3B

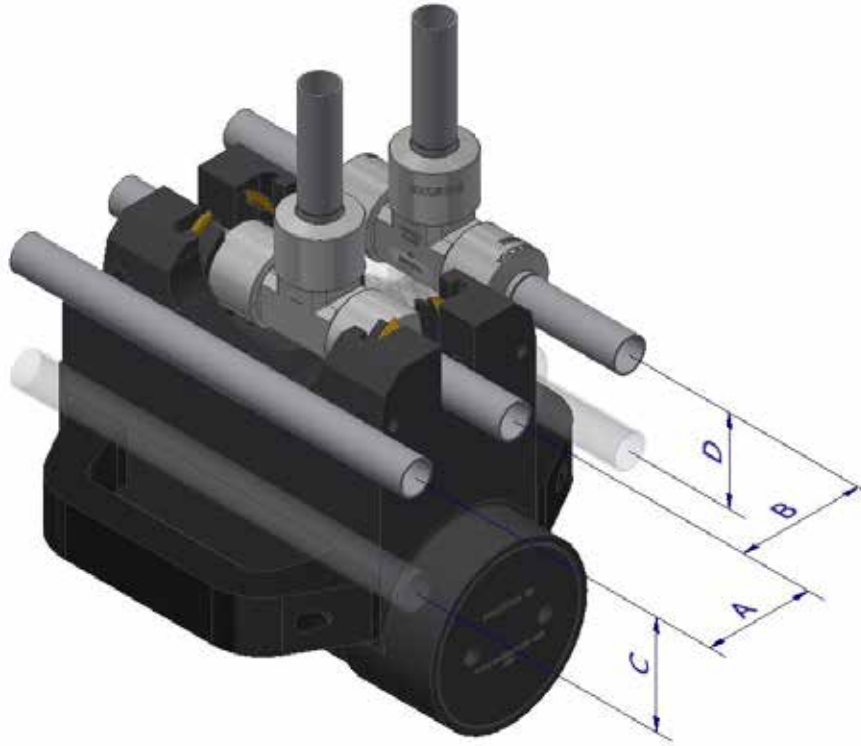

Permanent Compression
Instrument Fittings

Tube / Fitting Size			A	B	C	D
Size	Imperial	Metric				
4	1/4"	6mm	43.8 (1.72")	49.4 (1.94")	53.8 (2.12")	48.2 (1.90")
6	3/8"	10mm	45.3 (1.78")	51.9 (2.04")	52.2 (2.06")	45.7 (1.80")
8	1/2"	12mm	46.9 (1.85")	53.4 (2.10")	50.6 (1.99")	44.2 (1.74")
10	5/8"	16mm	48.5 (1.91")	56.8 (2.24")	49.1 (1.93")	40.7 (1.60")
12	3/4"	20mm	49.5 (1.95")	58 (2.28")	47.5 (1.87")	38.7 (1.52")
16	1"	25mm	52.7 (2.07")	65 (2.56")	44.3 (1.74")	31.7 (1.25")

- A - Minimum gap between Phastool® centreline and tube run centreline.
- B - Minimum gap between Phastool® centreline and Phastite® centreline.
- C - Maximum height between Phastool® centreline and tube run centreline.
- D - Maximum height between Phastool® centreline and Phastite® centreline.

Vice Mounted Tool

The Phastool® is supplied with metallic vice guards for working with the tool in a vice. Each bench mount bracket has two mounting holes as shown: each hole is suited to take an M4 socket cap screw.



Phastool® 3A with vice guards.

Complete Package

The tools are supplied in protective travel cases, complete with all accessories.

- Phastite® assembly tool
- Full insert range for the tool supplied
- Hydraulic pump (battery or hand operated pump for Phastool® 3A and 3B – mains or hand operated pump for Tri-Tool®)
- Pump controller unit (battery and mains operated pumps)
- 2x 28V Battery packs (battery operated pumps)
- 110V – 230V battery chargers (battery operated pumps)
- Ergonomic hand grip (Phastool® 3A) handles (Phastool® 3B) with retaining screws and hex key
- Phastool® vice guards with cap head screws
- Vice guards (Phastool® 3A and 3B)
- Hydraulic hose with quick connects



Protective case

Assembly Tools

Tri-Tool® Bench Mount

For 1/4" (6mm) to 1" (25mm) connections.

The Tri-Tool® is ideal for all sizes of Phastite®. The bench tool is supplied complete with a 1.5 metre hoses (5ft) and quick connectors to suit a 3/8-14 NPT pump connections port.

The unit is also supplied complete with all required jaw inserts for assembling all Phastite® connectors including shapes and termination product from 1/4" (6mm) to 1" (25mm).

Termination connectors can only be assembled using the Tri-Tool®.

Part No: PH-16-TOOL

Weight: 71 lbs (32 Kg)

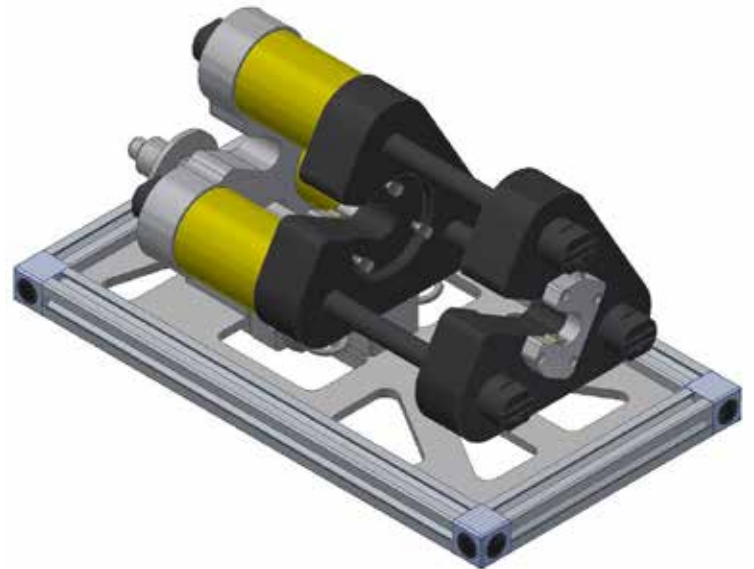

Tri-Tool® for connections 1/4 (6mm) to 1" (25mm)

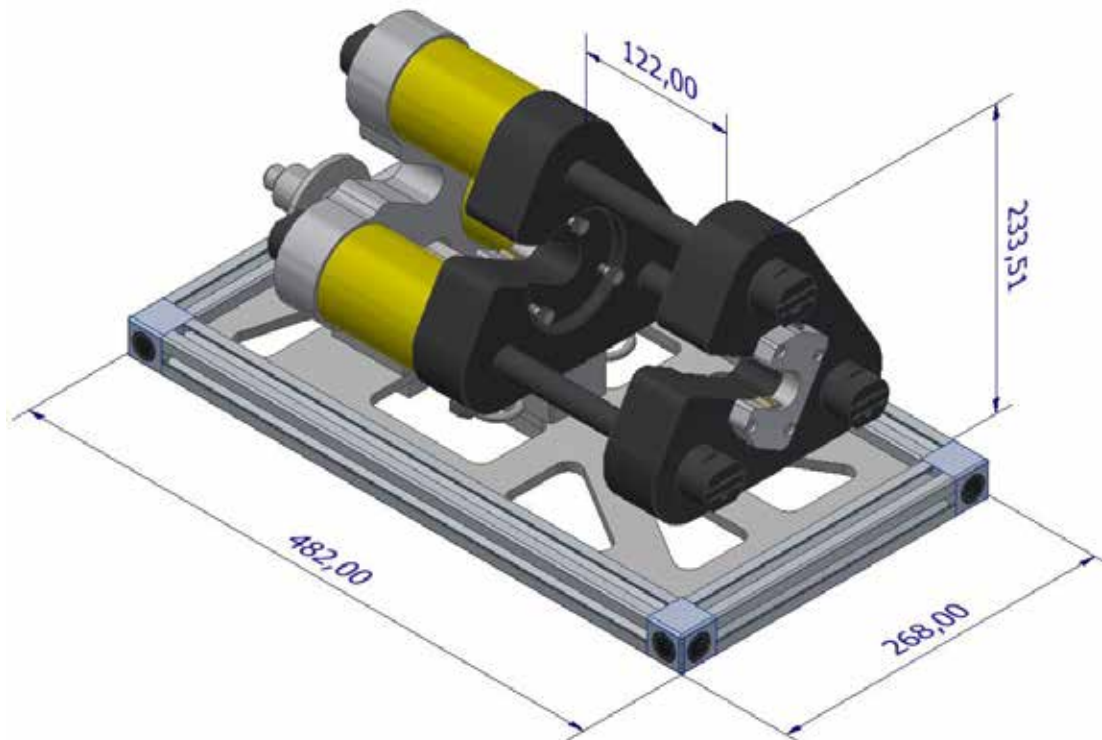

Basic dimensions of this tool are included for planning installations however for installation with limited access available it is advised to consult the factory for more information regarding jaw movement and access requirements.

Permanent Compression
Instrument Fittings

Tool Jaw Inserts

A complete set of jaw inserts are included with each tool kit (hand held or bench mounted) to enable assembly of all sizes and shapes of Phastite®. Quick and easy interchangeable tooling inserts allows the Tri-Tool® to install connectors from sizes 1/4" to 1". The insert selected is determined by the type of connector to be used and the size of the tubing. All inserts are etched with the part number and are colour coded. If additional inserts are required please use the information shown below.

Jaw inserts to suit hand held Phastool®

Tube Size O.D.	Tool	Part Number	Colour Code
1/4"	Phastool® 3A	PH-4-INSERTS-3A	GREY
	Phastool® 3B	PH-4-INSERTS-3B	
3/8"	Phastool® 3A	PH-6-INSERTS-3A	BLACK
	Phastool® 3B	PH-6-INSERTS-3B	
1/2"	Phastool® 3B	PH-8-INSERTS-3B	RED
5/8"	Phastool® 3B	PH-10-INSERTS-3B	YELLOW



Jaw inserts to suit Tri-Tool®

Tube Size O.D.	Tri-Tool Insert Part Number	Colour Code
1/4"	PH-M4-INSERTS-T16	GREY
3/8"	PH-M6-INSERTS-T16	BLACK
1/2"	PH-M8-INSERTS-T16	RED
5/8"	PH-M10-INSERTS-T16	YELLOW
3/4"	PH-M12-INSERTS-T16	BLUE
1"	PH-M16-INSERTS-T16	GREEN

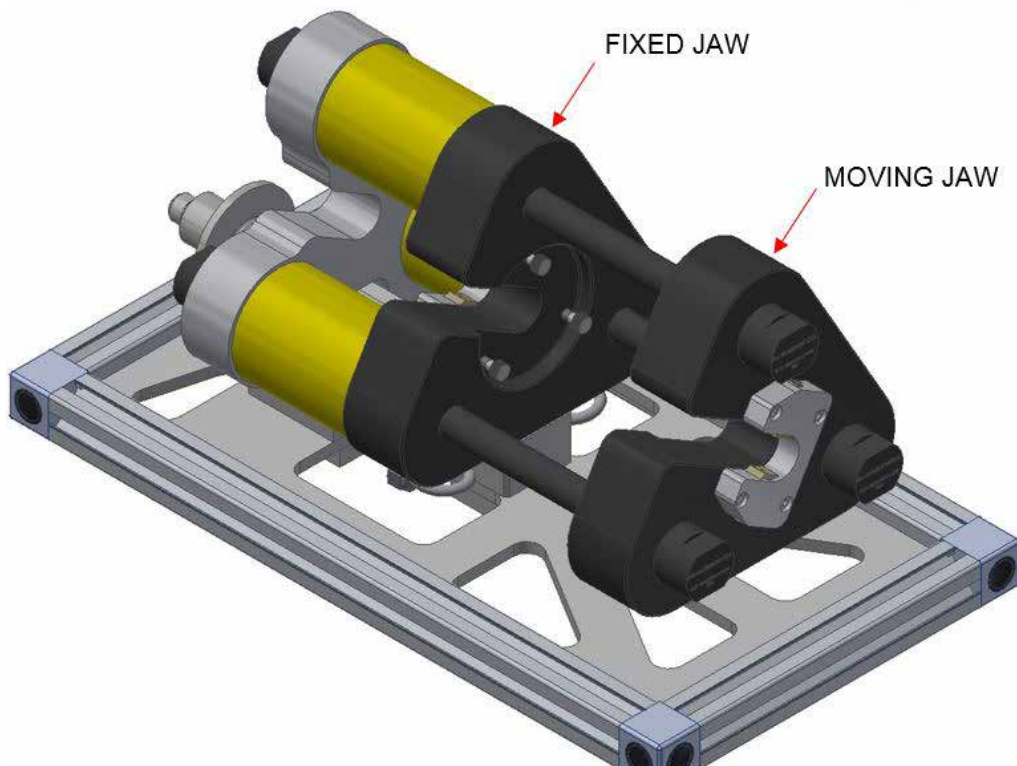

Permanent Compression
Instrument Fittings

Tubemarkers

Adequate tube insertion is essential. To achieve this, Phastite® Tube Markers are available. The Phastite® tube marker generates two visible lines on to the outside diameter of the tube.

When inserting the tube into a Phastite® connector the two lines should not be visible. This ensures adequate tube insertion prior to assembly. After assembly only one of the lines will be visible, ensuring that tube slippage has not occurred during assembly.

Permanent Tube Marker

This style of tube marker generates two permanent lines onto the tube. These lines can be used for initial inspection during assembly and for future inspection. These tube markers generate the marks by means of a metallic ball bearing being rotated against the tube.



How to Order:

The correct part number is easily derived from the following number sequence.

Example: PH-4-TUBEMARKER

PH	4		TUBEMARKER	
Series	Tube Size		Item	
PH	Imperial	1/4"	4	TUBEMARKER
		3/8"	6	
		1/2"	8	
		5/8"	10	
		3/4"	12	
		1"	16	
		Metric	6mm	
10mm	M10			
12mm	M12			
16mm	M16			
20mm	M20			
25mm	M25			

MPI™ Medium Pressure Fittings

Introduction

Parker Hannifin MPI™ Fittings are engineered and manufactured to provide secure, tight, and leak-resistant connections throughout industry, including off-shore oil and gas exploration platforms, research labs, and other facilities that require operating pressures in the range of 6,000 to 15,000 psi.

MPI™ Fittings are ideally suited to handle liquids, gases, or chemicals and can be used on a wide variety of tubing materials including cold drawn – 1/8 hard (unannealed) tubing or instrument grade thick-walled annealed stainless steel. Every Parker MPI™ Fitting is supplied complete and ready to install.

Materials and Identification

Standard MPI™ Fittings are made of Heat Code Traceable 316 stainless steel. Tubing and fitting materials should be selected based on compatibility with the fluid or gas media.

MPI™ Fittings Pressure Ratings

Part numbers for MPI™ Fittings use symbols that identify their style, size, and composition.

The maximum pressure rating is marked on each fitting. MPI™ working pressures to be determined by selected tubing. Please see tables on page 3 for specific working pressures.

- Size 4 MPI™ end – to 15,000 psi
- Size 6 MPI™ end – to 15,000 psi
- Size 8 MPI™ end – to 15,000 psi
- Size 9 MPI™ end – to 15,000 psi
- Size 12 MPI™ end – to 15,000 psi
- Size 16 MPI™ end – to 12,500 psi

Advanced Features

Every MPI™ Fitting has the features shown below:

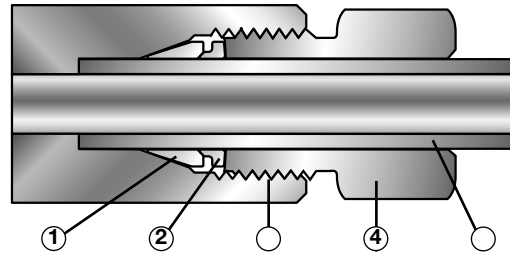

1. Front ferrule with corrosion-resistant Parker Suparcase® forms a tight pressure seal between the body and ferrule in a second strong mechanical hold on the tube.
2. Rear ferrule with corrosion-resistant Parker Suparcase® provides a strong mechanical hold on the tube.
3. Longer thread area for improved resistance to pressure and load on the ferrules.
4. Molybdenum disulfide-coated inverted nut helps prevent galling, provides easier assembly, and permits multiple remakes.
5. Long tube-support area improves resistance to vibration and line loads.

Assembly

MPI™ Fittings are installed with standard hand tools. Each size can be preset with a Parker hydraulic preset tool. Tube preparation does not require cutting of threads or tube end “coning.”

Dedication to Quality

Our resources and vast product line, is available through our worldwide distribution network.

For more information regarding our products and services, please contact your authorized Parker Instrumentation Distributor.



MPI™ Medium Pressure Fittings

Visual Index

MPI™ Fittings

MPI™ Male Connector
FBMP7
Page 183



37° Flare to MPI™ Connector
XHBMP7
Page 183



37° Flare Bulkhead to MPI™ Connector
MP7H2BX
Page 184



High Pressure to MPI™ Connector
X41HBMP7
Page 184



Medium Pressure to MPI™ Connector
X42HBMP7
Page 185



MPI™ to Female NPT Connector
GBMP7
Page 185



MPI™ to SAE Male O-ring Connector
MP7HBA
Page 186



Type “M” High Pressure Hose to MPI™ Connector
M40HBMP7
Page 186



MPI™ Bulkhead to Female NPT
GH2BMP7
Page 187

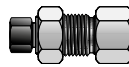

Connector
HBMP7
Page 187



MPI™ Bulkhead Union Connector
WBMP7
Page 188



MPI™ Male End to Female NPT
GM7
Page 188



MPI™ Male End to High Pressure C&T Port
GM7
Page 188



MPI™ Tube Port Connector
T7HBT7
Page 189

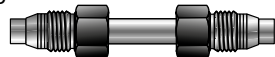

MPI™ Tube Stub to Male NPT Pipe
T7HF
Page 189

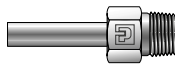

37° Flare to MPI™ Tube Stub
XHT7
Page 190

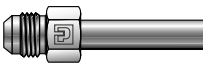

High Pressure to MPI™ Tube Stub
X41HT7
Page 190

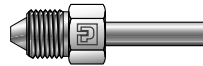

Medium Pressure Port Connector to MPI™ Tube Stub
X47HT7
Page 190

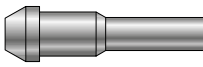

Medium Pressure to MPI™ Tube Stub
X42HT7
Page 191



MPI™ Tube Stub to Male SAE O-ring
T7HOA
Page 191



Type “M” High Pressure Hose Adapter to MPI™ Tube Stub
M40HT7
Page 191

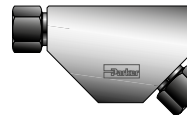

MPI™ Tube Stub Reduce
TRBMP7
Page 192

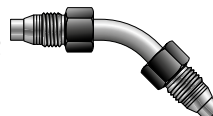

MPI™ Tube Stub to Female NPT Pipe
T7HG
Page 192



MPI™ Port Connector
MP7PC
Page 193

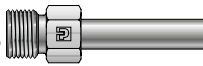

45° MPI™ Union Elbow
NBMP7
Page 193



45° MPI™ Tube Stub Elbow
T7NBT7
Page 194

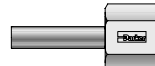

MPI™ Union Elbow
EBMP7
Page 194



MPI™ Tube Elbow
T7EBT7
Page 195

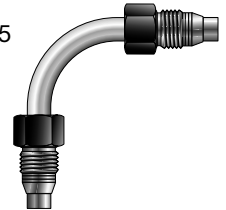

MPI™ to Male NPT Elbow
CBMP7
Page 195

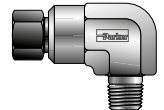

MPI™ Union Tee
JBMP7
Page 196



X44 Male by MPI™ Connector
X44HBMP7
Page 197



X44 Male by MPI™ Tube Stub
X44HT7
Page 197



Type “M” Male by X44 Male
M40HX44
Page 197



Adapter Assembly
X44
Page 197

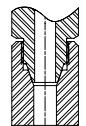

MPI™ to NPT Male Run Tee
RBMP7
Page 198

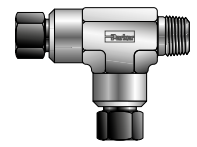

Medium Pressure Instrument Fittings

MPI™ Medium Pressure Fittings

Visual Index (Continued)

MPI™ to NPT Male

Branch Tee
SBMP7
Page 198

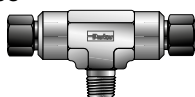

MPI™ to NPT

Female Branch Tee
OBMP7
Page 199



MPI™ Union Cross

KBMP7
Page 199

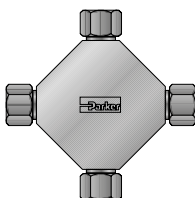

MPI™ Plug

FNMP7
Page 200

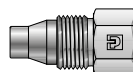

MPI™ Cap

PNBMP7
Page 200



MPI™ Front Ferrule

MPFF
Page 200



MPI™ Back Ferrule

MPBF
Page 200



MPI™ Nut

BMP7
Page 201



Gap Gauge

Page 201



MPI™ Medium Pressure Fittings

Typical Raw Material Specifications

Basic Fitting Material	Bar Stock	Forging
Stainless Steel (Type 316) (1)	ASME/ASTM SA/A-479 Type 316-SS ASTM A-276 Type 316 BS970 316-S31 DIN 4401	ASME SA-182 316 BS970 316-S31 DIN 4401

- (1) If additional information, including heat code traceability, is required, contact Parker Hannifin or your nearest MPI™ Fitting distributor.
- (2) Parker MPI™ Fittings work reliably on cold drawn - 1/8 hard tubing (both MPI™ and Cone & Thread), and fully annealed, heavy wall type 316 tubing. See page 182 for more information about tubing.

Tube End Dimensional Data

Size No.	Inches						
	Tube O.D.	Straight Thread	C	D	E	*L	W Hex
4	1/4	1/2 - 20	.50	1.34	.13	1.62	9/16
6	3/8	5/8 - 20	.63	1.58	.25	1.88	11/16
8	1/2	13/16 - 20	.69	1.85	.31	2.25	15/16
9	9/16	7/8 - 20	.75	1.91	.38	2.25	1
12	3/4	1 1/8 - 18	.88	2.26	.52	2.75	1 1/4
16	1	1 7/16 - 18	1.13	2.88	.69	3.38	1 1/2

*L - Recommended Straight Length of Circular Un-bent Tubing
Dimensions in inches are for reference only, subject to change.

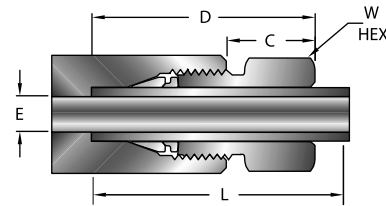

How To Order MPI™ Fittings

Dimensions in inches are for reference only, subject to change.

Parker MPI™ Fittings should be ordered using the part number as listed in this catalog.

Part numbers are developed as follows:

1. A combination of letters and numbers identifies the size and style of the fitting and the material used.
2. Tube and pipe thread sizes are designated by the number of sixteenths of an inch (1/4" tube = 4/16" or 4).

All standard MPI™ Fittings are manufactured from 316 stainless steel. Other materials are available upon special order.

Straights and Elbows: Specify the largest end of the MPI first, followed by the smaller tube end OR pipe thread size.

Example:

Part number 4-4 HBMP7 union would have the specifications listed below.

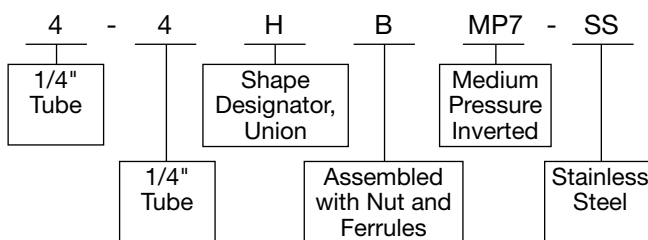
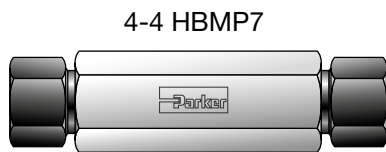

Tees:

Example:

Part number 9-6-6 JBMP7 would have the following specifications:

9-6-6 JBMP7

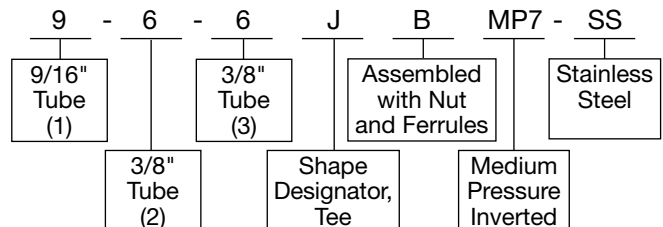
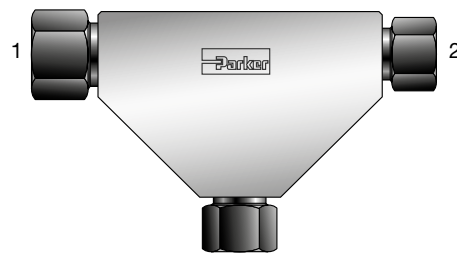

Customer Requests: When special configurations are required, please provide a blueprint of the installation to Parker with your request for a price quote.

Cryogenic Service: MPI™ fittings for cryogenic applications include a vent hole to prevent pressure build-up in front of the threads. To order "vented" MPI™ parts, add "-VT" to the end of the standard part number (e.g., 6-6 HBMP7-SS becomes 6-6 HBMP7-SS-VT).

MPI™ Medium Pressure Fittings

Tubing Selection Guide

Although Parker's MPI™ Fittings are engineered and manufactured to consistently provide high levels of reliability, no system's integrity is complete without considering the critical link: tubing.

This section is intended to help you properly select and order quality tubing, both annealed and medium-pressure cold drawn – 1/8 hard (unannealed).

Parker believes that proper tubing selection and installation are key to building leak-free, reliable tubing systems.

Parker's MPI™ Fittings have been designed to operate on a wide variety of "medium pressure" applications (6,000 to 15,000 psi).

General Selection Criteria

The data tables in this section will help you select the tubing that best satisfies the needs of the application.

The most important consideration in the selection of suitable tubing for any application is the compatibility of the tubing materials with the media to be contained.

System Pressure

The system operating pressure is another important factor in determining the type, and more importantly, the size of tubing to be used. In general, high pressure installations require strong materials such as stainless steel. Tube fitting assemblies should never be pressurized beyond the recommended working pressure.

Temperature Derating Factors

Table 1 indicates derating factors for 316 stainless steel tubing and MPI™ fittings at elevated temperatures.

Table 1

		Temperature Derating Factors (316 Stainless Steel Tubing)									
°F	-425 to 100	200	300	400	500	600	700	800	900	1000	
°C	-254 to 38	93	149	204	260	316	371	427	482	538	
1/8 Hard*	1.000	1.000	1.000	0.960	0.885	0.835	0.795	0.770	0.750	0.740	
Annealed**	1.000	1.000	1.000	0.965	0.895	0.850	0.815	0.795	0.775	0.765	

* Use with 1/8 Hard 316 tubing shown in Tables 2 and 3 on page 3.

** Use with Annealed 316 tubing shown in Table 4 on page 3.

The rating at temperature is the room temperature (RT) pressure rating listed in the catalog multiplied by the Derating Factor at temperature.

Example: 1/4" MPI™ fittings and tubing @ 800°F

Room Temperature Working Pressure
= 15,000 psi (as shown in Table 2)

800°F Temperature Derating Factor
= .770 (1/8 Hard tube) (as shown above)

**800°F Working Pressure
= 15,000 x .770 = 11,550 psi**

MPI™ Medium Pressure Fittings

Maximum Allowable Working Pressure Tables

Tables 2, 3 and 4 list the maximum suggested working pressure of various tubing sizes, according to material. Acceptable tubing diameters and wall thicknesses are those for which a rating is listed. Combinations which do not have a pressure rating are not recommended for use with MPI™ Fittings.

MPI™ Tubing

MPI™ tubing is marked “MPI” and is designed to provide optimum performance for MPI™ fittings. MPI™ tubing is nominal OD ± .003" 316 seamless stainless steel, cold drawn – 1/8 hard (unannealed) tubing. Tensile strength is approximately 40% higher than annealed tubing.

Table 2 – 316 Stainless Steel (Seamless / Unannealed – 1/8 Hard)

Tube Size (in.)	Nominal OD (in.)	Nominal ID (in.)	Working Pressure (psi)	MPI™ Tube Part No.
1/4	.250	.125	15,000	4-240 MPITube-SS-15K
3/8	.375	.219	15,000	6-240 MPITube-SS-15K
9/16	.562	.344	15,000	9-240 MPITube-SS-15K
3/4	.750	.469	15,000	12-240 MPITube-SS-15K
1	1.000	.656	12,500	16-240 MPITube-SS-12K

NOTE: Working pressures calculated using an allowable stress of 35,000 psi for 1/8 hard 316 stainless steel tubing with a minimum tensile strength of 105,000 psi.

NOTE: Sizes 3/4" & 1" require hydraulic presetting when used with MPI™ fittings.

*Consult factory for pressure tables regarding other materials.

Dimensions in inches are for reference only, subject to change.

Cone & Thread Tubing

Cone & Thread (C&T) tubing is available as 1/8 hard 316 seamless stainless steel tubing and is designed to work with existing C&T fittings. C&T tubing has an undersized OD by as much as .010" to better facilitate the coning and threading operations required for use with C&T fittings. MPI™ fittings work effectively with C&T tubing as listed below but **require hydraulic presetting** for optimum performance.

Table 3 – 316 Stainless Steel (Undersized OD, Seamless / Unannealed – 1/8 Hard)

Tube Size (in.)	Maximum OD (in.)	Nominal ID (in.)	Working Pressure (psi)	Tube Size (in.)	Maximum OD (in.)	Nominal ID (in.)	Working Pressure (psi)
1/4	.250	.109	12,500	9/16	.562	.359	10,000
3/8	.375	.203	12,500	3/4	.750	.516	10,000
9/16	.562	.312	12,500	1	1.000	.688	10,000

Dimensions in inches are for reference only, subject to change.

Instrumentation Grade Heavy Wall Tubing

Table 4 – 316 Stainless Steel (Seamless / Annealed)

Tube Size (in.)	Tube Wall Thickness (in.)								
	.065	.083	.095	.109	.120	.134	.156	.188	.220
Working Pressure (psi)									
1/4	10,300	13,300							
3/8	6,600	8,600	10,000	11,700					
1/2		6,700	7,800	9,100	10,000	11,400			
3/4				5,800	6,400	7,300	8,600	10,600	
1					4,700	5,300	6,200	7,700	9,200

NOTE: Working pressures calculated using an allowable stress of 20,000 psi for annealed 316 stainless steel tubing with a nominal O.D. tolerance of ± .005".

Dimensions in inches are for reference only, subject to change.

MPI™ Medium Pressure Fittings

FBMP7

MPI™ to Male NPT Connector

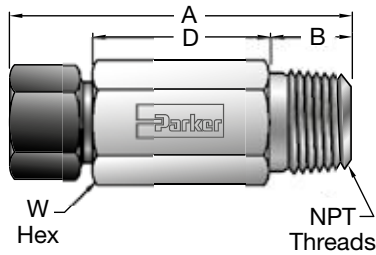

Parker Part No.	Inches						Working Pressure (PSIG)
	MPI™ Size	NPT Thread	A	B	D	W Hex	
4-2 FBMP7	1/4	1/8 - 27	1.91	.38	1.03	5/8	15,000
4-4 FBMP7	1/4	1/4 - 18	2.10	.57	1.03	5/8	15,000
4-6 FBMP7	1/4	3/8 - 18	2.00	.57	.93	3/4	15,000
4-8 FBMP7	1/4	1/2 - 14	2.17	.76	.91	7/8	15,000
6-4 FBMP7	3/8	1/4 - 18	2.43	.57	1.24	3/4	15,000
6-6 FBMP7	3/8	3/8 - 18	2.43	.57	1.24	3/4	15,000
6-8 FBMP7	3/8	1/2 - 14	2.48	.76	1.10	7/8	15,000
8-6 FBMP7	1/2	3/8 - 18	2.85	.57	1.60	1	15,000
8-8 FBMP7	1/2	1/2 - 14	2.81	.76	1.37	1	15,000
9-6 FBMP7	9/16	3/8 - 18	2.91	.57	1.59	1 1/16	15,000
9-8 FBMP7	9/16	1/2 - 14	3.04	.76	1.53	1 1/16	15,000
12-8 FBMP7	3/4	1/2 - 14	3.85	.76	2.21	1 3/8	15,000
12-12 FBMP7	3/4	3/4 - 14	3.46	.76	1.82	1 3/8	10,000
16-12 FBMP7	1	3/4 - 14	4.53	.76	2.64	1 3/4	10,000
16-16 FBMP7	1	1 - 11.5	4.58	.95	2.50	1 3/4	10,000

Dimensions in inches are for reference only, subject to change.

XHBMP7

37° Flare to MPI™ Connector

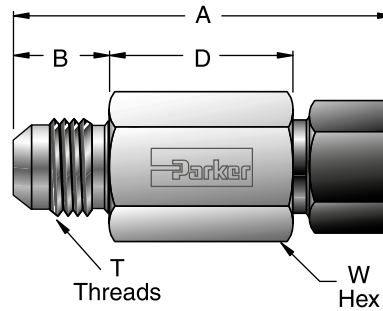

Parker Part No.	Inches							Working Pressure (PSIG)
	37° Flare Adapter	MPI™ Size	A	B	D	T Thread	W Hex	
4-4 XHBMP7	1/4	1/4	2.08	.55	1.03	7/16 - 20	5/8	15,000
4-6 XHBMP7	1/4	3/8	2.54	.55	1.37	7/16 - 20	3/4	15,000
4-8 XHBMP7	1/4	1/2	2.90	.55	1.66	7/16 - 20	1	15,000
4-9 XHBMP7	1/4	9/16	2.96	.55	1.66	7/16 - 20	1 1/16	15,000
6-4 XHBMP7	3/8	1/4	1.97	.56	.92	9/16 - 18	5/8	12,500
6-6 XHBMP7	3/8	3/8	2.24	.56	1.06	9/16 - 18	3/4	12,500
6-8 XHBMP7	3/8	1/2	2.90	.56	1.66	9/16 - 18	1	12,500
6-9 XHBMP7	3/8	9/16	2.97	.56	1.66	9/16 - 18	1 1/16	12,500
8-6 XHBMP7	1/2	3/8	2.34	.66	1.06	3/4 - 16	13/16	12,500
8-8 XHBMP7	1/2	1/2	2.69	.66	1.34	3/4 - 16	1	12,500
8-9 XHBMP7	1/2	9/16	2.77	.66	1.36	3/4 - 16	1 1/16	12,500
8-12 XHBMP7	1/2	3/4	3.38	.86	1.63	1-1/16 - 12	1 3/8	12,500
16-16 XHBMP7	1	1	4.23	.91	2.19	1-5/16 - 12	1 3/4	7,200

Dimensions in inches are for reference only, subject to change.

MPI™ Medium Pressure Fittings

MP7H2BX 37° Flare Bulkhead to MPI™ Connector

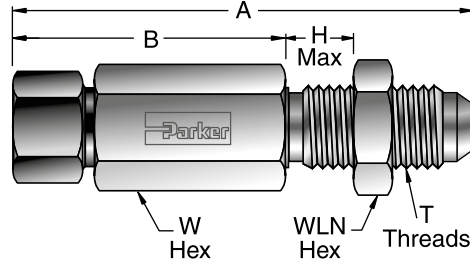

Parker Part No.	Inches								Working Pressure (PSIG)
	MPI™ Size	37° Flare Adapter	A	C	H Max	T Thread	WLN Hex	W Hex	
4-4 MP7H2BX	1/4	1/4	2.76	1.53	.40	7/16 - 20	11/16	5/8	15,000
6-6 MP7H2BX	3/8	3/8	3.24	1.93	.48	9/16 - 18	13/16	3/4	12,500
8-8 MP7H2BX	1/2	1/2	3.44	1.97	.50	3/4 - 16	1	1	12,500
9-8 MP7H2BX	9/16	1/2	3.76	2.29	.50	3/4 - 16	1	1 1/16	12,500

* Bulkhead hole approximately 1/64" (.015") larger than thread major diameter.

Dimensions in inches are for reference only, subject to change.

X41HBMP7 High Pressure Cone & Thread to MPI™ Connector

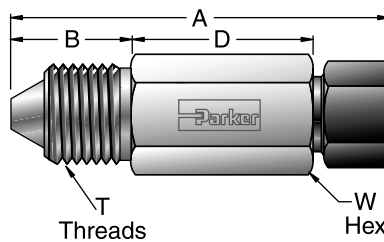

Parker Part No.	Inches								Working Pressure (PSIG)
	High Pressure Adapter	High Pressure Connection	MPI™ Size	A	B	D	T Thread	W Hex	
4-4 X41HBMP7	1/4	F250C	1/4	2.25	.72	1.03	9/16 - 18	5/8	15,000
4-6 X41HBMP7	1/4	F250C	3/8	2.71	.72	1.37	9/16 - 18	3/4	15,000
6-4 X41HBMP7	3/8	F375C	1/4	2.52	.92	1.10	3/4 - 16	13/16	15,000
6-6 X41HBMP7	3/8	F375C	3/8	2.92	.92	1.37	3/4 - 16	13/16	15,000
6-9 X41HBMP7	3/8	F375C	9/16	3.37	.92	1.70	3/4 - 16	1 1/16	15,000
9-6 X41HBMP7	9/16	F562C	3/8	3.12	1.13	1.37	1 1/8 - 12	1 3/16	15,000
9-9 X41HBMP7	9/16	F562C	9/16	3.58	1.13	1.70	1 1/8 - 12	1 3/16	15,000
9-12 X41HBMP7	9/16	F562C	3/4	4.03	1.13	2.02	1 1/8 - 12	1 3/8	15,000

Dimensions in inches are for reference only, subject to change.

Medium Pressure Instrument Fittings

MPI™ Medium Pressure Fittings

X42HBMP7 Medium Pressure Cone & Thread to MPI™ Connector

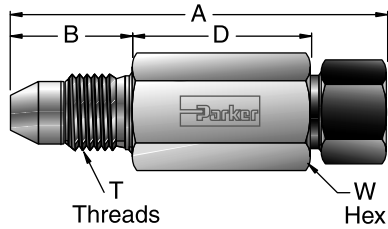

Parker Part No.	Inches								Working Pressure (PSIG)
	Medium Pressure Adapter	Medium Pressure Connection	MPI™ Size	A	B	D	T Thread	W Hex	
4-4 X42HBMP7	1/4	SF250CX	1/4	2.34	.81	1.03	7/16 - 20	5/8	15,000
4-6 X42HBMP7	1/4	SF250CX	3/8	2.80	.81	1.37	7/16 - 20	3/4	15,000
4-9 X42HBMP7	1/4	SF250CX	9/16	3.31	.81	1.75	7/16 - 20	1-1/16	15,000
6-4 X42HBMP7	3/8	SF375CX	1/4	2.47	.94	1.03	9/16 - 18	3/4	15,000
6-6 X42HBMP7	3/8	SF375CX	3/8	2.93	.94	1.37	9/16 - 18	3/4	15,000
6-8 X42HBMP7	3/8	SF375CX	1/2	3.28	.94	1.65	9/16 - 18	1	15,000
6-9 X42HBMP7	3/8	SF375CX	9/16	3.44	.94	1.75	9/16 - 18	1-1/16	15,000
9-4 X42HBMP7	9/16	SF562CX	1/4	2.56	1.13	.93	13/16 - 16	7/8	15,000
9-6 X42HBMP7	9/16	SF562CX	3/8	2.85	1.13	1.10	13/16 - 16	7/8	15,000
9-8 X42HBMP7	9/16	SF562CX	1/2	3.16	1.13	1.35	13/16 - 16	1	15,000
9-9 X42HBMP7	9/16	SF562CX	9/16	3.41	1.13	1.54	13/16 - 16	1-1/16	15,000
9-12 X42HBMP7	9/16	SF562CX	3/4	4.20	1.13	2.19	13/16 - 16	1-3/8	15,000
12-9 X42HBMP7	3/4	SF750CX	9/16	3.55	1.31	1.35	3/4 - 14 NPS	1-1/16	15,000
12-12 X42HBMP7	3/4	SF750CX	3/4	4.15	1.31	1.96	3/4 - 14 NPS	1-3/8	15,000
12-16 X42HBMP7	3/4	SF750CX	1	5.27	1.31	2.83	3/4 - 14 NPS	1-3/4	12,500

Dimensions in inches are for reference only, subject to change.

GBMP7 MPI™ Female NPT Connector

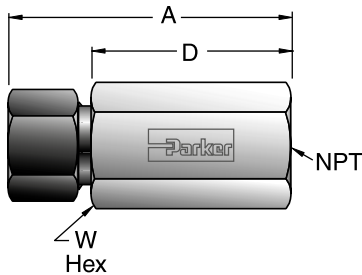

4-2 GBMP7	1/4	1/8 - 27	2.06	1.56	13/16	15,000
4-4 GBMP7	1/4	1/4 - 18	2.25	1.75	1	15,000
4-6 GBMP7	1/4	3/8 - 18	2.35	1.85	1 1/8	15,000
4-8 GBMP7	1/4	1/2 - 14	2.58	2.08	1 3/8	15,000
6-2 GBMP7	3/8	1/8 - 27	2.37	1.74	13/16	15,000
6-4 GBMP7	3/8	1/4 - 18	2.56	1.93	1	15,000
6-6 GBMP7	3/8	3/8 - 18	2.66	2.03	1 1/8	15,000
6-8 GBMP7	3/8	1/2 - 14	2.87	2.24	1 3/8	15,000
8-4 GBMP7	1/2	1/4 - 18	2.89	2.20	1	15,000
8-6 GBMP7	1/2	3/8 - 18	2.99	2.30	1 1/8	15,000
8-8 GBMP7	1/2	1/2 - 14	3.20	2.51	1 3/8	15,000
9-4 GBMP7	9/16	1/4 - 18	2.68	2.18	1 3/8	15,000
9-6 GBMP7	9/16	3/8 - 18	2.93	2.30	1 1/8	15,000
9-8 GBMP7	9/16	1/2 - 14	3.26	2.51	1 3/8	15,000
12-8 GBMP7	3/4	1/2 - 14	3.70	2.82	1 3/8	15,000

Dimensions in inches are for reference only, subject to change.

Medium Pressure Instrument Fittings

MPI™ Medium Pressure Fittings

MP7HBA

MPI™ to SAE Male
O-Ring Connector

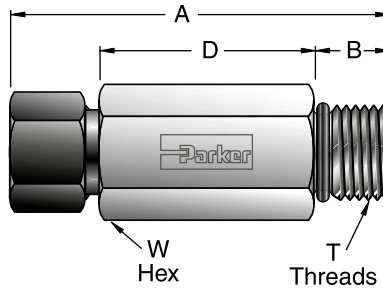

Parker Part No.	Inches							Working Pressure (PSIG)
	MPI™ Size	SAE* End	A	B	D	T Thread	W Hex	
4-4 MP7HBA	1/4	1/4	1.90	.43	.97	7/16 - 20	5/8	12,500
4-6 MP7HBA	1/4	3/8	1.94	.47	.97	9/16 - 18	11/16	12,500
4-8 MP7HBA	1/4	1/2	1.97	.55	.91	3/4 - 16	7/8	12,500
6-4 MP7HBA	3/8	1/4	2.41	.43	1.35	7/16 - 20	3/4	12,500
6-6 MP7HBA	3/8	3/8	2.20	.47	1.10	9/16 - 18	3/4	12,500
6-8 MP7HBA	3/8	1/2	2.23	.55	1.05	3/4 - 16	7/8	12,500
8-4 MP7HBA	1/2	1/4	2.81	.43	1.69	7/16 - 20	1	12,500
8-6 MP7HBA	1/2	3/8	2.82	.47	1.66	9/16 - 18	1	12,500
8-8 MP7HBA	1/2	1/2	2.60	.55	1.36	3/4 - 16	1	12,500
9-6 MP7HBA	9/16	3/8	2.89	.47	1.67	9/16 - 18	1 1/16	12,500
9-8 MP7HBA	9/16	1/2	2.89	.55	1.59	3/4 - 16	1 1/16	12,500

*All male o-ring ends for MPI™ fittings are heavy duty and comply with SAE J1926-2. This end has maximum thread engagement for strength and requires the minimum full thread engagement specified in SAE J1926 for the female port. Standard O-ring material is Nitrile #N0552-90.

Dimensions in inches are for reference only, subject to change.

M40HBMP7

Type "M" High Pressure Hose
to MPI™ Connector

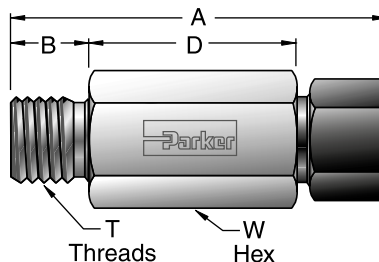

Parker Part No.	Inches							Working Pressure (PSIG)
	HOSE* Adapter	MPI™ Size	A	B	D	T Thread	W Hex	
6-4 M40HBMP7	- 6	1/4	2.03	.50	1.03	9/16 - 18	5/8	15,000
6-6 M40HBMP7	- 6	3/8	2.45	.50	1.32	9/16 - 18	3/4	15,000
8-6 M40HBMP7	- 8	3/8	2.57	.63	1.32	3/4 - 16	13/16	15,000
8-8 M40HBMP7	- 8	1/2	2.90	.63	1.59	3/4 - 16	1	15,000
8-9 M40HBMP7	- 8	9/16	2.97	.63	1.59	3/4 - 16	1-1/16	15,000
10-4 M40HBMP7	- 10	1/4	2.39	.75	1.14	7/8 - 14	15/16	15,000
10-6 M40HBMP7	- 10	3/8	2.72	.75	1.34	7/8 - 14	15/16	15,000
11-8 M40HBMP7	- 11	1/2	2.89	.63	1.58	1 - 12	1-1/16	15,000
11-9 M40HBMP7	- 11	9/16	2.95	.63	1.58	1 - 12	1-1/16	15,000
11-12 M40HBMP7	-11	3/4	3.59	.63	2.08	1 - 12	1-3/8	15,000
16-16 M40HBMP7	- 16	1	3.88	.63	2.13	1-5/16 - 12	1-3/4	12,500

* Adapts to Type "M" Swivel Hose Connection.

Dimensions in inches are for reference only, subject to change.

Medium Pressure Instrument Fittings

MPI™ Medium Pressure Fittings

GH2BMP7 MPI™ Bulkhead to Female NPT Connector

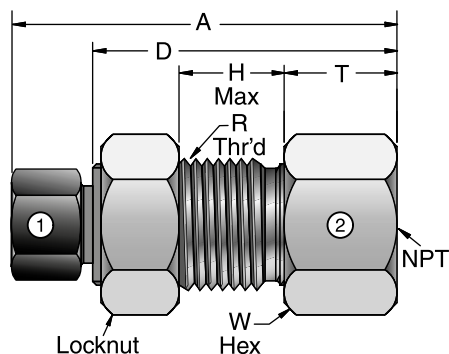

Parker Part No.	Inches								Working Pressure (PSIG)
	MPI™ Size	NPT Thread	A	D	H Max.	R Thread	T	W Hex	
4-4 GH2BMP7	1/4	1/4 - 18	2.38	1.88	.56	3/4 - 20	.75	1	15,000
6-8 GH2BMP7	3/8	1/2 - 14	3.13	2.50	.63	7/8 - 20	1.25	1-3/8	15,000
6-12 GH2BMP7	3/8	3/4 - 14	3.19	2.56	.63	7/8 - 20	1.31	1-1/2	10,000
8-12 GH2BMP7	1/2	3/4 - 14	3.50	2.81	.75	1-1/8 - 20	1.31	1-1/2	10,000
9-4 GH2BMP7	9/16	1/4 - 18	2.82	2.07	.63	1-1/8 - 20	.69	1-3/8	15,000

* Bulkhead hole approximately 1/64" (.015") larger than thread major diameter.

Dimensions in inches are for reference only, subject to change.

HBMP7 MPI™ Union Connector

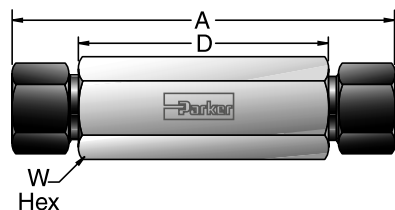

Parker Part No.	Inches				Working Pressure (PSIG)
	MPI™ Size	A	D	W Hex	
4-4 HBMP7	1/4	2.88	1.88	5/8	15,000
6-4 HBMP7	3/8 - 1/4	3.32	2.19	3/4	15,000
6-6 HBMP7	3/8	3.44	2.19	3/4	15,000
8-4 HBMP7	1/2 - 1/4	3.88	2.70	1	15,000
8-6 HBMP7	1/2 - 3/8	4.01	2.70	1	15,000
8-8 HBMP7	1/2	4.07	2.70	1	15,000
9-4 HBMP7	9/16 - 1/4	3.95	2.70	1-1/16	15,000
9-6 HBMP7	9/16 - 3/8	4.07	2.70	1-1/16	15,000
9-8 HBMP7	9/16 - 1/2	4.13	2.70	1-1/16	15,000
9-9 HBMP7	9/16	4.20	2.70	1-1/16	15,000
12-6 HBMP7	3/4 - 3/8	4.76	3.25	1-3/8	15,000
12-9 HBMP7	3/4 - 9/16	5.15	3.51	1-3/8	15,000
12-12 HBMP7	3/4	5.08	3.31	1-3/8	15,000
16-16 HBMP7	1	6.52	4.25	1-3/4	12,500

Dimensions in inches are for reference only, subject to change.

MPI™ Medium Pressure Fittings

WBMP7 MPI™ Bulkhead Union Connector

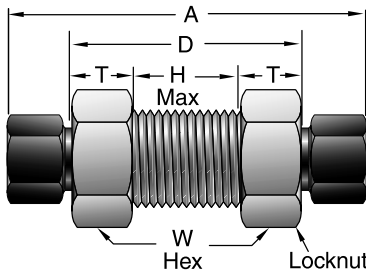

Parker Part No.	Inches							Working Pressure (PSIG)
	MPI™ Size	A	D	H Max	T	*R Threads	W Hex	
4-4 WBMP7	1/4	2.88	1.88	.88	.50	3/4-20	1	15,000
6-6 WBMP7	3/8	3.44	2.19	1.07	.56	7/8-20	1 1/8	15,000
8-8 WBMP7	1/2	4.07	2.70	1.32	.69	1 1/8-20	1 3/8	15,000
8-9 WBMP7	1/2 - 9/16	4.20	2.70	1.32	.69	1 1/8-20	1 3/8	15,000
9-8 WBMP7	9/16 - 1/2	4.20	2.70	1.32	.69	1 1/8-20	1 3/8	15,000
9-9 WBMP7	9/16	4.20	2.70	1.32	.69	1 1/8-20	1 3/8	15,000
12-12 WBMP7	3/4	5.08	3.31	1.56	.88	1 7/16-18	1 7/8	15,000
16-16 WBMP7	1	6.52	4.25	2.00	1.13	1 7/8-12	2 1/2	12,500

* Bulkhead hole approximately 1/64" (.015") larger than thread major diameter.
Dimensions in inches are for reference only, subject to change.

GM7 MPI™ Male End to Female NPT

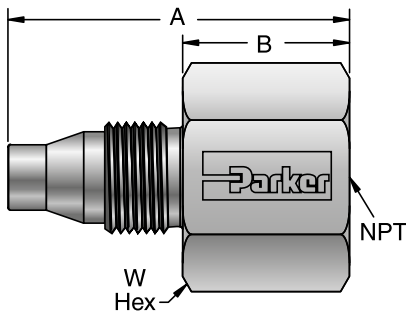

Parker Part No.	Inches						Working Pressure (PSIG)
	MPI™ Male Thread ¹	Female NPT End	A	B	NPT Thread	W Hex	
4-4 GM7	1/4	1/4	1.73	.85	1/4 - 18	1	15,000
4-6 GM7	1/4	3/8	1.83	.95	3/8 - 18	1 1/8	15,000
6-4 GM7	3/8	1/4	1.84	.85	1/4 - 18	1	15,000
6-6 GM7	3/8	3/8	1.94	.95	3/8 - 18	1 1/8	15,000
6-8 GM7	3/8	1/2	2.17	1.17	1/2 - 14	1 3/8	15,000
8-4 GM7	1/2	1/4	2.05	.85	1/4 - 18	1	15,000
8-6 GM7	1/2	3/8	2.15	.95	3/8 - 18	1 1/8	15,000
8-8 GM7	1/2	1/2	2.37	1.17	1/2 - 14	1 3/8	15,000
9-4 GM7	9/16	1/4	2.05	.85	1/4 - 18	1	15,000
9-6 GM7	9/16	3/8	2.15	.95	3/8 - 18	1 1/8	15,000
9-8 GM7	9/16	1/2	2.37	1.17	1/2 - 14	1 3/8	15,000
12-4 GM7	3/4	1/4	2.17	.75	1/4 - 18	1 1/4	15,000
12-6 GM7	3/4	3/8	2.17	.75	3/8 - 18	1 1/4	15,000
12-8 GM7	3/4	1/2	2.59	1.17	1/2 - 14	1 3/8	15,000

¹Assemble 1/4 to 1/2 turn from finger tight & lubricate threads & taper before each remake.
Dimensions in inches are for reference only, subject to change.

GM7 MPI™ Male End to High Pressure C&T Port

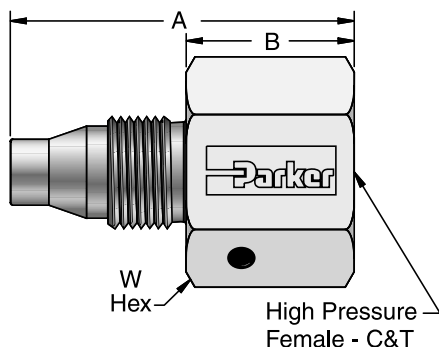

Parker Part No.	Inches						Working Pressure (PSIG)
	MPI™ Male Thread ¹	High Press C&T Port	A	B	C&T Thread	W Hex	
4-4HF GM7	1/4	1/4	1.57	.69	9/16 - 18	3/4	15,000
6-4HF GM7	3/8	1/4	1.68	.69	9/16 - 18	3/4	15,000
6-6HF GM7	3/8	3/8	1.87	.88	3/4 - 16	1	15,000
8-4HF GM7	1/2	1/4	1.89	.69	9/16 - 18	15/16	15,000
8-6HF GM7	1/2	3/8	2.07	.88	3/4 - 16	1	15,000
9-4HF GM7	9/16	1/4	1.89	.69	9/16 - 18	1	15,000
9-6HF GM7	9/16	3/8	2.07	.88	3/4 - 16	1	15,000
12-4HF GM7	3/4	1/4	2.17	.75	9/16 - 18	1 1/4	15,000
12-6HF GM7	3/4	3/8	2.30	.88	3/4 - 16	1 1/4	15,000

¹Assemble 1/4 to 1/2 turn from finger tight & lubricate threads & taper before each remake.
Dimensions in inches are for reference only, subject to change.

Medium Pressure Instrument Fittings

MPI™ Medium Pressure Fittings

T7HBT7

MPI™ Tube Port Connector

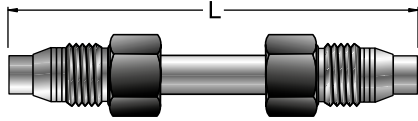

Parker Part No.	Inches		Working Pressure (PSIG)
	Tube Size	L	
* 4 T7HBT7-SS	1/4	2.72	15,000
4 T7HBT7-SS 4.0	1/4	4.00	15,000
4 T7HBT7-SS 6.0	1/4	6.00	15,000
4 T7HBT7-SS 8.0	1/4	8.00	15,000
4 T7HBT7-SS 10.0	1/4	10.00	15,000
4 T7HBT7-SS 12.0	1/4	12.00	15,000
* 6 T7HBT7-SS	3/8	3.19	15,000
6 T7HBT7-SS 4.0	3/8	4.00	15,000
6 T7HBT7-SS 6.0	3/8	6.00	15,000
6 T7HBT7-SS 8.0	3/8	8.00	15,000
6 T7HBT7-SS 10.0	3/8	10.00	15,000
6 T7HBT7-SS 12.0	3/8	12.00	15,000
* 9 T7HBT7-SS	9/16	3.85	15,000
9 T7HBT7-SS 6.0	9/16	6.00	15,000
9 T7HBT7-SS 8.0	9/16	8.00	15,000
9 T7HBT7-SS 10.0	9/16	10.00	15,000
9 T7HBT7-SS 12.0	9/16	12.00	15,000
* 12 T7HBT7-SS	3/4	4.55	15,000
12 T7HBT7-SS 6.0	3/4	6.00	15,000
12 T7HBT7-SS 8.0	3/4	8.00	15,000
12 T7HBT7-SS 10.0	3/4	10.00	15,000
12 T7HBT7-SS 12.0	3/4	12.00	15,000

Assemble 1/2 turn from finger tight.

* Same Assembled Length as MP7PC.

Dimensions in inches are for reference only, subject to change.

T7HF

MPI™ Tube Stub to Male NPT Pipe

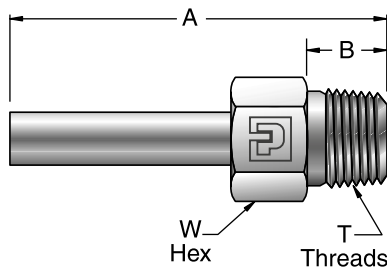

Parker Part No.	Inches						Working Pressure (PSIG)
	MPI™ Tube Stub	Male NPT End	A	B	NPT Thread	W Hex	
4-4 T7HF	1/4	1/4	2.32	.57	1/4 - 18	5/8	15,000
4-6 T7HF	1/4	3/8	2.44	.57	3/8 - 18	3/4	15,000
4-8 T7HF	1/4	1/2	2.76	.76	1/2 - 14	7/8	15,000
6-4 T7HF	3/8	1/4	2.56	.57	1/4 - 18	5/8	15,000
6-6 T7HF	3/8	3/8	2.68	.57	3/8 - 18	3/4	15,000
6-8 T7HF	3/8	1/2	2.99	.76	1/2 - 14	7/8	15,000
8-4 T7HF	1/2	1/4	2.82	.57	1/4 - 18	5/8	15,000
8-6 T7HF	1/2	3/8	2.95	.57	3/8 - 18	3/4	15,000
8-8 T7HF	1/2	1/2	3.26	.76	1/2 - 14	7/8	15,000
9-4 T7HF	9/16	1/4	2.88	.57	1/4 - 18	5/8	15,000
9-6 T7HF	9/16	3/8	3.01	.57	3/8 - 18	3/4	15,000
9-8 T7HF	9/16	1/2	3.32	.76	1/2 - 14	7/8	15,000
9-12 T7HF	9/16	3/4	3.43	.76	3/4 - 14	1 1/8	10,000
12-8 T7HF	3/4	1/2	3.67	.76	1/2 - 14	7/8	15,000
12-12 T7HF	3/4	3/4	3.80	.76	3/4 - 14	1 1/8	10,000

Add "-Z6" to part number for part assembled with preset ferrules and nuts.
Dimensions in inches are for reference only, subject to change.

MPI™ Medium Pressure Fittings

XHT7

37° Flare to MPI™
Tube Stub

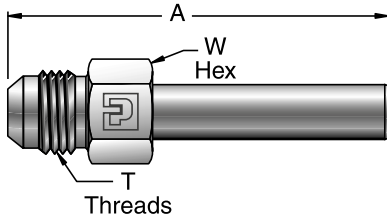

Parker Part No.	Inches					Working Pressure (PSIG)
	37° Flare Adapter Size	MPI™ Tube Stub	A	T Thread	W Hex	
4-4 XHT7	1/4	1/4	2.24	7/16 - 20	1/2	15,000
4-6 XHT7	1/4	3/8	2.47	7/16 - 20	1/2	15,000
6-4 XHT7	3/8	1/4	2.37	9/16 - 18	5/8	12,500
6-6 XHT7	3/8	3/8	2.60	9/16 - 18	5/8	12,500
6-8 XHT7	3/8	1/2	2.87	9/16 - 18	5/8	12,500
6-9 XHT7	3/8	9/16	2.93	9/16 - 18	5/8	12,500
8-6 XHT7	1/2	3/8	2.77	3/4 - 16	13/16	12,500
8-8 XHT7	1/2	1/2	3.04	3/4 - 16	13/16	12,500
8-9 XHT7	1/2	9/16	3.10	3/4 - 16	13/16	12,500

Add "-Z6" to part number for part assembled with preset ferrules and nuts.
Dimensions in inches are for reference only, subject to change.

X41HT7

High Pressure to MPI™
Tube Stub

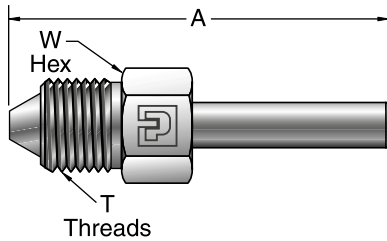

Parker Part No.	Inches					Working Pressure (PSIG)
	High Pressure Adapter Size	MPI™ Tube Stub	A	T Thread	W Hex	
4-4 X41HT7	1/4	1/4	2.59	9/16 - 18	5/8	15,000
4-6 X41HT7	1/4	3/8	2.83	9/16 - 18	5/8	15,000
4-8 X41HT7	1/4	1/2	3.10	9/16 - 18	5/8	15,000
4-9 X41HT7	1/4	9/16	3.16	9/16 - 18	5/8	15,000
6-4 X41HT7	3/8	1/4	2.92	3/4 - 16	13/16	15,000
6-6 X41HT7	3/8	3/8	3.16	3/4 - 16	13/16	15,000
6-8 X41HT7	3/8	1/2	3.43	3/4 - 16	13/16	15,000
6-9 X41HT7	3/8	9/16	3.49	3/4 - 16	13/16	15,000
9-4 X41HT7	9/16	1/4	3.25	1 1/8 - 12	1-3/16	15,000
9-6 X41HT7	9/16	3/8	3.49	1 1/8 - 12	1-3/16	15,000
9-8 X41HT7	9/16	1/2	3.75	1 1/8 - 12	1-3/16	15,000
9-9 X41HT7	9/16	9/16	3.82	1 1/8 - 12	1-3/16	15,000

Add "-Z6" to part number for part assembled with preset ferrules and nuts.
Dimensions in inches are for reference only, subject to change.

X47HT7

Medium Pressure Port
Connector to MPI™ Tube Stub

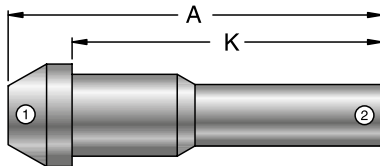

Parker Part No.	Inches				Working Pressure (PSIG)
	MP Port Connector #1	MPI Tube Stub #2	A	K	
9-6 X47HT7	9/16	3/8	3.21	1.61	15,000
9-9 X47HT7	9/16	9/16	3.53	3.03	15,000
12-9 X47HT7	3/4	9/16	3.72	1.94	15,000
12-12 X47HT7	3/4	3/4	4.07	3.44	15,000
16-9 X47HT7	1	9/16	4.23	3.44	15,000
16-12 X47HT7	1	3/4	4.57	3.79	15,000
16-16 X47HT7	1	1	5.19	4.41	12,500

End # 1 must be used with a Medium Pressure Gland.

Add "-Z6" to part number for part assembled with preset ferrules and nuts.
Dimensions in inches are for reference only, subject to change.

Medium Pressure Instrument Fittings

MPI™ Medium Pressure Fittings

X42HT7

Medium Pressure to MPI™ Tube Stub

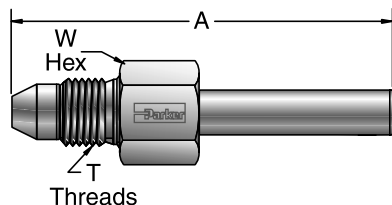

Parker Part No.	Inches					Working Pressure (PSIG)
	Medium Pressure Adapter Size	MPI™ Tube Stub	A	T Thread	W Hex	
4-4 X42HT7	1/4	1/4	2.68	7/16 - 20	5/8	15,000
4-6 X42HT7	1/4	3/8	2.92	7/16 - 20	5/8	15,000
4-8 X42HT7	1/4	1/2	3.18	7/16 - 20	5/8	15,000
4-9 X42HT7	1/4	9/16	3.25	7/16 - 20	5/8	15,000
6-4 X42HT7	3/8	1/4	2.94	9/16 - 18	3/4	15,000
6-6 X42HT7	3/8	3/8	3.17	9/16 - 18	3/4	15,000
6-8 X42HT7	3/8	1/2	3.44	9/16 - 18	3/4	15,000
6-9 X42HT7	3/8	9/16	3.50	9/16 - 18	3/4	15,000
9-4 X42HT7	9/16	1/4	3.25	13/16 - 16	7/8	15,000
9-6 X42HT7	9/16	3/8	3.49	13/16 - 16	7/8	15,000
9-8 X42HT7	9/16	1/2	3.75	13/16 - 16	7/8	15,000
9-9 X42HT7	9/16	9/16	3.81	13/16 - 16	7/8	15,000
9-12 X42HT7	9/16	3/4	4.16	13/16 - 16	7/8	15,000
12-9 X42HT7	3/4	9/16	4.00	3/4 - 14 NPS	1 1/8	15,000
12-12 X42HT7	3/4	3/4	4.35	3/4 - 14 NPS	1 1/8	15,000

Add “-Z6” to part number for part assembled with preset ferrules and nuts.

Dimensions in inches are for reference only, subject to change.

T7HOA

MPI™ Tube Stub to Male SAE O-ring

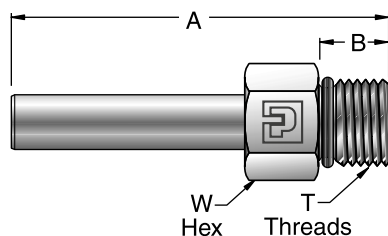

Parker Part No.	Inches						Working Pressure (PSIG)
	MPI™ Tube Stub	SAE O-Ring End	A	B	T Thread	W Hex	
4-4 T7HOA	1/4	1/4	2.25	.43	7/16 - 20	9/16	12,500
4-6 T7HOA	1/4	3/8	2.35	.47	9/16 - 18	11/16	12,500
4-8 T7HOA	1/4	1/2	2.49	.55	3/4 - 16	7/8	12,500
6-4 T7HOA	3/8	1/4	2.48	.43	7/16 - 20	9/16	12,500
6-6 T7HOA	3/8	3/8	2.58	.47	9/16 - 18	11/16	12,500
6-8 T7HOA	3/8	1/2	2.72	.55	3/4 - 16	7/8	12,500
8-4 T7HOA	1/2	1/4	2.75	.43	7/16 - 20	9/16	12,500
8-6 T7HOA	1/2	3/8	2.85	.47	9/16 - 18	11/16	12,500
8-8 T7HOA	1/2	1/2	2.99	.55	3/4 - 16	7/8	12,500
9-4 T7HOA	9/16	1/4	2.81	.43	7/16 - 20	5/8	12,500
9-6 T7HOA	9/16	3/8	2.91	.47	9/16 - 18	11/16	12,500
9-8 T7HOA	9/16	1/2	3.05	.55	3/4 - 16	7/8	12,500

Add “-Z6” to part number for part assembled with preset ferrules and nuts.

* All male o-ring ends for MPI™ fittings are heavy duty and comply with SAE J1926-2. This end has maximum thread engagement for strength and requires the minimum full thread engagement specified in SAE J9126 for the female port. Standard O-ring material is Nitrile #N0552-90.

Dimensions in inches are for reference only, subject to change.

M40HT7

Type “M” High Pressure Hose Adapter to MPI™ Tube Stub

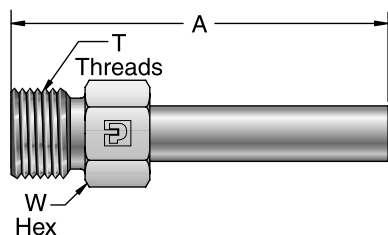

Parker Part No.	Inches					Working Pressure (PSIG)
	Hose* Adapter Size	MPI™ Tube Stub	A	T Thread	W Hex	
6-4 M40HT7	-6	1/4	2.31	9/16 - 18	5/8	15,000
6-6 M40HT7	-6	3/8	2.55	9/16 - 18	5/8	15,000
8-6 M40HT7	-8	3/8	2.74	3/4 - 16	13/16	15,000
8-9 M40HT7	-8	9/16	3.12	3/4 - 16	13/16	15,000
11-6 M40HT7	-11	3/8	2.99	1 - 12	1 1/16	15,000
11-9 M40HT7	-11	9/16	3.31	1 - 12	1 1/16	15,000
11-12 M40HT7	-11	3/4	3.66	1 - 12	1 1/16	15,000
16-12 M40HT7	-16	3/4	3.91	1 5/16 - 12	1 3/8	15,000
16-16 M40HT7	-16	1	4.51	1 5/16 - 12	1 3/8	12,500

Add “-Z6” to part number for part assembled with preset ferrules and nuts.

Dimensions in inches are for reference only, subject to change.

Medium Pressure Instrument Fittings

MPI™ Medium Pressure Fittings

TRBMP7 MPI™ Tube Stub Reducer

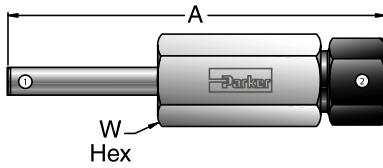

Parker Part No.	Inches				Working Pressure (PSIG)
	MPI™ Tube Stub #1	MPI™ Size #2	A	W Hex	
4-6 TRBMP7	1/4	3/8	3.49	3/4	15,000
4-8 TRBMP7	1/4	1/2	3.94	1	15,000
4-9 TRBMP7	1/4	9/16	4.00	1 1/16	15,000
6-4 TRBMP7	3/8	1/4	3.30	5/8	15,000
6-8 TRBMP7	3/8	1/2	4.17	1	15,000
6-9 TRBMP7	3/8	9/16	4.24	1 1/16	15,000
8-4 TRBMP7	1/2	1/4	3.56	5/8	15,000
8-6 TRBMP7	1/2	3/8	3.99	3/4	15,000
9-4 TRBMP7	9/16	1/4	3.63	5/8	15,000
9-6 TRBMP7	9/16	3/8	4.06	3/4	15,000
9-12 TRBMP7	9/16	3/4	4.97	1 3/8	15,000
12-4 TRBMP7	3/4	1/4	4.17	13/16	15,000
12-6 TRBMP7	3/4	3/8	4.42	13/16	15,000
12-9 TRBMP7	3/4	9/16	4.82	1 1/16	15,000

Add "-Z6" to part number for part assembled with preset ferrules and nuts.
Dimensions in inches are for reference only, subject to change.

T7HG MPI™ Tube Stub to Female NPT Pipe

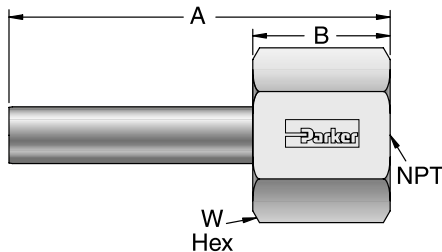

Parker Part No.	Inches						Working Pressure (PSIG)
	MPI™ Tube Stub	Female NPT End	A	B	NPT Thread	W Hex	
4-2 T7HG	1/4	1/8	2.09	.72	1/8 - 27	13/16	15,000
4-4 T7HG	1/4	1/4	2.28	.91	1/4 - 18	1	15,000
4-8 T7HG	1/4	1/2	2.64	1.27	1/2 - 14	1 3/8	15,000
6-2 T7HG	3/8	1/8	2.33	.72	1/8 - 27	13/16	15,000
6-4 T7HG	3/8	1/4	2.52	.91	1/4 - 18	1	15,000
6-8 T7HG	3/8	1/2	2.88	1.27	1/2 - 14	1 3/8	15,000
8-2 T7HG	1/2	1/8	2.60	.72	1/8 - 27	13/16	15,000
8-4 T7HG	1/2	1/4	2.79	.91	1/4 - 18	1	15,000
8-8 T7HG	1/2	1/2	3.14	1.27	1/2 - 14	1 3/8	15,000
9-4 T7HG	9/16	1/4	2.84	.91	1/4 - 18	1	15,000
9-8 T7HG	9/16	1/2	3.20	1.27	1/2 - 14	1 3/8	15,000
12-8 T7HG	3/4	1/2	3.55	1.27	1/2 - 14	1 3/8	15,000
12-12 T7HG	3/4	3/4	3.60	1.31	3/4 - 11 1/2	1 1/2	10,000
16-16 T7HG	1	1	4.38	1.50	1 - 11 1/2	1 7/8	10,000

Add "-Z6" to part number for part assembled with preset ferrules and nuts.
Dimensions in inches are for reference only, subject to change.

Medium Pressure Instrument Fittings

MPI™ Medium Pressure Fittings

MP7PC

MPI™ Port Connector

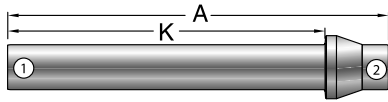

Parker Part No.	Inches				Working Pressure (PSIG)
	MPI™ Tube Stub #1	MPI™ Port #2 ¹	A	K	
4-4 MP7PC	1/4	1/4	2.69	2.23	15,000
4-6 MP7PC	1/4	3/8	2.93	2.40	15,000
6-6 MP7PC	3/8	3/8	3.17	2.64	15,000
6-8 MP7PC	3/8	1/2	3.43	2.68	15,000
6-9 MP7PC	3/8	9/16	3.50	2.75	15,000
8-8 MP7PC	1/2	1/2	3.70	2.95	15,000
9-9 MP7PC	9/16	9/16	3.82	3.07	15,000
9-12 MP7PC	9/16	3/4	4.17	3.32	15,000
12-12 MP7PC	3/4	3/4	4.52	3.67	15,000
12-16 MP7PC	3/4	1	5.12	4.07	12,500
16-16 MP7PC	1	1	5.74	4.70	12,500

¹ Assemble 1/4 to 1/2 turn from finger tight.

Add "-Z6" to part number for part assembled with preset ferrules and nuts. Dimensions in inches are for reference only, subject to change.

NBMP7

45° MPI™ Union Elbow

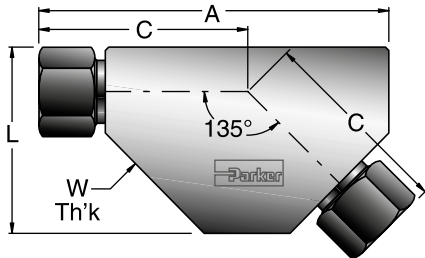

Parker Part No.	Inches					Working Pressure (PSIG)
	MPI™ Size	A	C	L	W Th'k	
4-4 NBMP7	1/4	2.56	1.50	1.38	5/8	15,000
6-6 NBMP7	3/8	3.10	1.81	1.63	3/4	15,000
8-8 NBMP7	1/2	3.76	2.18	2.13	1	15,000
9-9 NBMP7	9/16	3.82	2.24	2.13	1	15,000
12-12 NBMP7	3/4	4.76	2.82	2.63	1 3/8	15,000

Dimensions in inches are for reference only, subject to change.

MPI™ Medium Pressure Fittings

T7NBT7 45° MPI™ Tube Stub Elbow

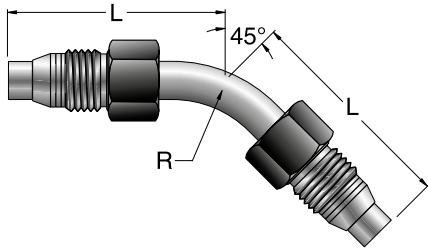

Parker Part No.	Inches			Working Pressure (PSIG)
	Tube Size	L	R	
4 T7NBT7-SS	1/4	1.69	0.75	15,000
* 4 T7NBT7-SS 2.9	1/4	2.88	0.75	15,000
4 T7NBT7-SS 6.0	1/4	6.00	0.75	15,000
4 T7NBT7-SS 8.0	1/4	8.00	0.75	15,000
4 T7NBT7-SS 10.0	1/4	10.00	0.75	15,000
4 T7NBT7-SS 12.0	1/4	12.00	0.75	15,000
6 T7NBT7-SS	3/8	2.14	1.25	15,000
* 6 T7NBT7-SS 3.4	3/8	3.42	1.25	15,000
6 T7NBT7-SS 6.0	3/8	6.00	1.25	15,000
6 T7NBT7-SS 8.0	3/8	8.00	1.25	15,000
6 T7NBT7-SS 10.0	3/8	10.00	1.25	15,000
6 T7NBT7-SS 12.0	3/8	12.00	1.25	15,000
9 T7NBT7-SS	9/16	2.77	2.00	15,000
* 9 T7NBT7-SS 4.2	9/16	4.18	2.00	15,000
9 T7NBT7-SS 6.0	9/16	6.00	2.00	15,000
9 T7NBT7-SS 8.0	9/16	8.00	2.00	15,000
9 T7NBT7-SS 10.0	9/16	10.00	2.00	15,000
9 T7NBT7-SS 12.0	9/16	12.00	2.00	15,000
12 T7NBT7-SS	3/4	3.55	3.00	15,000
12 T7NBT7-SS 5.1	3/4	5.11	3.00	15,000
12 T7NBT7-SS 6.0	3/4	6.00	3.00	15,000
12 T7NBT7-SS 8.0	3/4	8.00	3.00	15,000
12 T7NBT7-SS 10.0	3/4	10.00	3.00	15,000
12 T7NBT7-SS 12.0	3/4	12.00	3.00	15,000

Assemble 1/2 turn from finger tight.

* Similar Assembled Lengths as NBMP7 with two (2) MP7PCs.
Dimensions in inches are for reference only, subject to change.

EBMP7 MPI™ Union Elbow

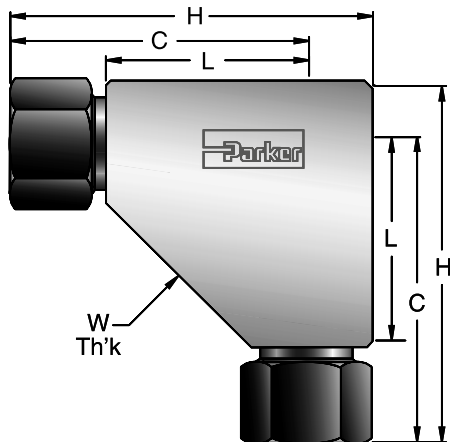

Parker Part No.	MPI™ Size	Inches				Working Pressure (PSIG)
		C	H	L	W Th'k	
4-4 EBMP7	1/4	1.53	1.88	1.03	5/8	15,000
6-6 EBMP7	3/8	1.86	2.25	1.24	3/4	15,000
8-8 EBMP7	1/2	2.22	2.81	1.54	1	15,000
9-9 EBMP7	9/16	2.29	2.88	1.54	1	15,000
12-12 EBMP7	3/4	2.82	3.51	1.94	1 3/8	15,000
16-16 EBMP7	1	3.63	4.51	2.50	1 3/4	12,500

Dimensions in inches are for reference only, subject to change.

Medium Pressure Instrument Fittings

MPI™ Medium Pressure Fittings

T7EBT7 MPI™ Tube Elbow

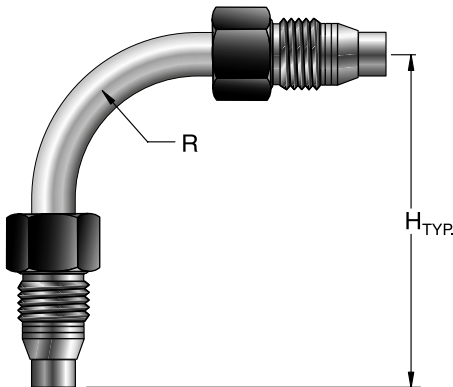

Parker Part No.	Inches			Working Pressure (PSIG)
	Tube Size	H	R	
4 T7EBT7-SS	1/4	2.12	0.75	15,000
* 4 T7EBT7-SS 2.9	1/4	2.91	0.75	15,000
4 T7EBT7-SS 6.0	1/4	6.00	0.75	15,000
4 T7EBT7-SS 8.0	1/4	8.00	0.75	15,000
4 T7EBT7-SS 10.0	1/4	10.00	0.75	15,000
4 T7EBT7-SS 12.0	1/4	12.00	0.75	15,000
6 T7EBT7-SS	3/8	2.88	1.25	15,000
* 6 T7EBT7-SS 3.5	3/8	3.47	1.25	15,000
6 T7EBT7-SS 6.0	3/8	6.00	1.25	15,000
6 T7EBT7-SS 8.0	3/8	8.00	1.25	15,000
6 T7EBT7-SS 10.0	3/8	10.00	1.25	15,000
6 T7EBT7-SS 12.0	3/8	12.00	1.25	15,000
* 9 T7EBT7-SS	9/16	4.22	2.00	15,000
9 T7EBT7-SS 6.0	9/16	6.00	2.00	15,000
9 T7EBT7-SS 8.0	9/16	8.00	2.00	15,000
9 T7EBT7-SS 10.0	9/16	10.00	2.00	15,000
9 T7EBT7-SS 12.0	9/16	12.00	2.00	15,000
12 T7EBT7-SS	3/4	5.31	3.00	15,000
12 T7EBT7-SS 6.0	3/4	6.00	3.00	15,000
12 T7EBT7-SS 8.0	3/4	8.00	3.00	15,000
12 T7EBT7-SS 10.0	3/4	10.00	3.00	15,000
12 T7EBT7-SS 12.0	3/4	12.00	3.00	15,000

Assemble 1/2 turn from finger tight.

* Same Assembled Lengths as EBMP7 with two (2) MP7PCs.
Dimensions in inches are for reference only, subject to change.

CBMP7 MPI™ to Male NPT Elbow

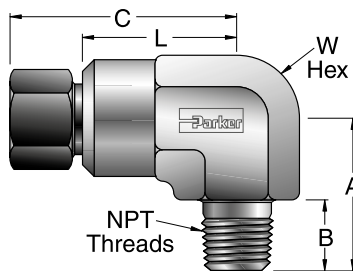

Parker Part No.	Inches							Working Pressure (PSIG)
	MPI™ Size	NPT Thread	A	B	C	L	W Hex	
4-4 CBMP7	1/4	1/4 - 18	1.13	.57	1.53	1.03	3/4	15,000
4-6 CBMP7	1/4	3/8 - 18	1.13	.57	1.56	1.06	3/4	12,000
4-8 CBMP7	1/4	1/2 - 14	1.41	.76	1.64	1.14	3/4	10,000
6-4 CBMP7	3/8	1/4 - 18	1.23	.57	1.86	1.24	7/8	12,500
6-6 CBMP7	3/8	3/8 - 18	1.23	.57	1.86	1.24	7/8	12,000
6-8 CBMP7	3/8	1/2 - 14	1.41	.76	1.92	1.30	7/8	10,000

Dimensions in inches are for reference only, subject to change.

MPI™ Medium Pressure Fittings

JBMP7 MPI™ Union Tee

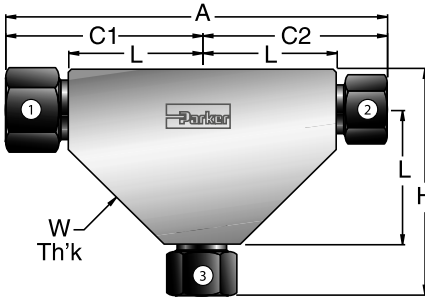

Parker Part No.	Inches									Working Pressure (PSIG)
	MPI™ Size #1	MPI™ Size #2	MPI™ Size #3	A	C1	C2	H	L	W Th'k	
4-4-4 JBMP7	1/4	1/4	1/4	3.06	1.53	1.53	1.88	1.03	5/8	15,000
6-6-6 JBMP7	3/8	3/8	3/8	3.72	1.86	1.86	2.25	1.24	3/4	15,000
8-8-8 JBMP7	1/2	1/2	1/2	4.45	2.22	2.22	2.81	1.54	1	15,000
9-9-9 JBMP7	9/16	9/16	9/16	4.57	2.29	2.29	2.88	1.54	1	15,000
12-12-12 JBMP7	3/4	3/4	3/4	5.64	2.82	2.82	3.51	1.94	1 3/8	15,000
16-16-16 JBMP7	1	1	1	7.27	3.63	3.63	4.51	2.50	1 3/4	12,500
4-4-6 JBMP7	1/4	1/4	3/8	3.47	1.74	1.74	2.25	1.24	3/4	15,000
6-6-4 JBMP7	3/8	3/8	1/4	3.72	1.86	1.86	2.13	1.24	3/4	15,000
6-4-4 JBMP7	3/8	1/4	1/4	3.60	1.86	1.74	2.13	1.24	3/4	15,000
6-6-8 JBMP7	3/8	3/8	1/2	4.32	2.16	2.16	2.81	1.54	1	15,000
6-6-9 JBMP7	3/8	3/8	9/16	4.45	2.16	2.29	2.88	1.54	1	15,000
8-8-6 JBMP7	1/2	1/2	3/8	4.45	2.22	2.22	2.75	1.54	1	15,000
8-6-6 JBMP7	1/2	3/8	3/8	4.38	2.22	2.16	2.75	1.54	1	15,000
9-9-4 JBMP7	9/16	9/16	1/4	4.57	2.29	2.29	2.63	1.54	1	15,000
9-9-6 JBMP7	9/16	9/16	3/8	4.57	2.29	2.29	2.75	1.54	1	15,000
9-6-4 JBMP7	9/16	3/8	1/4	4.45	2.29	2.16	2.63	1.54	1	15,000
9-6-6 JBMP7	9/16	3/8	3/8	4.45	2.29	2.16	2.75	1.54	1	15,000
12-12-9 JBMP7	3/4	3/4	9/16	5.64	2.82	2.82	3.38	1.94	1 3/8	15,000
16-16-9 JBMP7	1	1	9/16	7.27	3.63	3.63	4.13	2.50	1 3/4	12,500
16-16-12 JBMP7	1	1	3/4	7.27	3.63	3.63	4.26	2.50	1 3/4	12,500

Dimensions in inches are for reference only, subject to change.

Medium Pressure Instrument Fittings

MPI™ Medium Pressure Fittings

X44HBMP7

X44 Male by MPI™ Connector

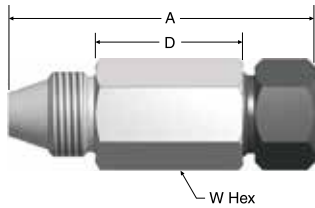

Parker Part No.	Inches					Working Pressure (PSIG)
	Medium Pressure Connection	MPI™ Size	A	D	W Hex	
9-9 X44HBMP7	9/16	9/16	3.20	1.54	1-1/16	15,000
9-12 X44HBMP7	9/16	3/4	3.98	2.19	1-3/8	15,000
12-9 X44HBMP7	3/4	9/16	3.15	1.35	1-1/4	15,000
12-12 X44HBMP7	3/4	3/4	3.89	1.96	1-3/8	15,000

Dimensions in inches are for reference only, subject to change.

X44HT7

X44 Male by MPI™ Tube Stub

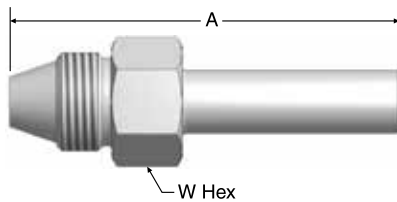

Parker Part No.	Inches				Working Pressure (PSIG)
	Medium Pressure Connection	MPI™ Tube	A	W Hex	
9-9 X44HT7	9/16	9/16	3.60	1	15,000
9-12 X44HT7	9/16	3/4	3.95	1	15,000
12-9 X44HT7	3/4	9/16	3.74	1-1/4	15,000
12-12 X44HT7	3/4	3/4	4.09	1-1/4	15,000

Dimensions in inches are for reference only, subject to change.

M40HX44

Type "M" Male by X44 Male

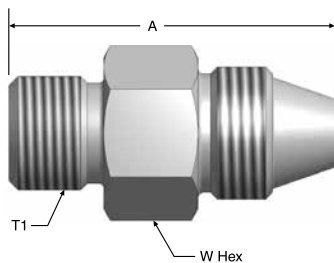

Parker Part No.	Inches					Working Pressure (PSIG)
	Type "M" Adapter	X44 Adapter	T1 Thread	A	W Hex	
6-9 M40HX44	3/8	9/16	9/16-18 UNF	1.79	1	15,000
6-12 M40HX44	3/8	3/4	9/16-18 UNF	2.06	1-1/4	15,000
8-9 M40HX44	1/2	9/16	3/4-16 UNF	1.99	1	15,000
8-12 M40HX44	1/2	3/4	3/4-16 UNF	2.18	1-1/4	15,000
11-9 M40HX44	11/16	9/16	1-12 UNF	2.04	1-1/16	15,000
11-12 M40HX44	11/16	3/4	1-12 UNF	2.18	1-1/4	15,000

Dimensions in inches are for reference only, subject to change.

X44 Adapter Assembly

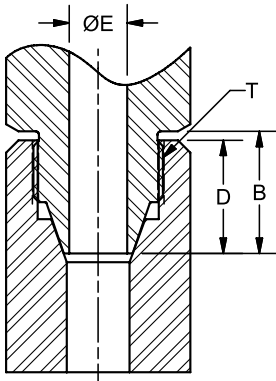

Size	T Thread	B	D Insertion Depth	ØE	Assembly Torque
9	7/8-14	0.91	0.84	0.38	80 ft-lb
12	1-1/8-12	1.05	0.98	0.50	165 ft-lb

Dimensions in inches are for reference only, subject to change.

MPI™ Medium Pressure Fittings

RBMP7 MPI™ to Male Run NPT Tee

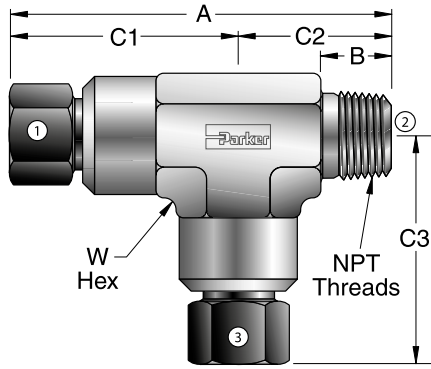

Parker Part No.	Inches									Working Pressure (PSIG)
	MPI™ Size #1	NPT Thread #2	MPI™ Size #3	A	C1	C2	C3	B	W Hex	
4-4-4 RBMP7	1/4	1/4 - 18	1/4	2.76	1.63	1.13	1.63	.57	3/4	15,000
4-4-6 RBMP7	1/4	1/4 - 18	3/8	2.85	1.63	1.23	1.86	.57	7/8	12,500
4-6-4 RBMP7	1/4	3/8 - 18	1/4	2.76	1.63	1.13	1.63	.57	3/4	12,000
4-6-6 RBMP7	1/4	3/8 - 18	3/8	2.85	1.63	1.23	1.86	.57	7/8	12,000
6-4-4 RBMP7	3/8	1/4 - 18	1/4	3.09	1.86	1.23	1.63	.57	7/8	12,500
6-4-6 RBMP7	3/8	1/4 - 18	3/8	3.09	1.86	1.23	1.86	.57	7/8	12,500
6-6-4 RBMP7	3/8	3/8 - 18	1/4	3.09	1.86	1.23	1.63	.57	7/8	12,000
6-6-6 RBMP7	3/8	3/8 - 18	3/8	3.09	1.86	1.23	1.86	.57	7/8	12,000

Dimensions in inches are for reference only, subject to change.

SBMP7 MPI™ to Male Branch NPT Tee

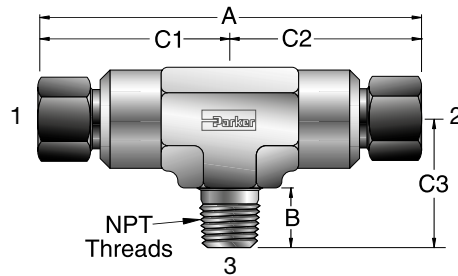

Parker Part No.	Inches									Working Pressure (PSIG)
	MPI™ Size #1	MPI™ Size #2	NPT Thread #3	A	C1	C2	C3	B	W Hex	
4-4-4 SBMP7	1/4	1/4 - 18	1/4	3.25	1.63	1.63	1.13	.57	3/4	15,000
4-4-6 SBMP7	1/4	3/8 - 18	3/8	3.25	1.63	1.63	1.13	.57	3/4	12,000
6-6-4 SBMP7	3/8	1/4 - 18	3/8	3.72	1.86	1.86	1.23	.57	7/8	12,500
6-6-6 SBMP7	3/8	3/8 - 18	3/8	3.72	1.86	1.86	1.23	.57	7/8	12,000

Dimensions in inches are for reference only, subject to change.

Medium Pressure Instrument Fittings

MPI™ Medium Pressure Fittings

OBMP7 MPI™ to NPT Female Branch Tee

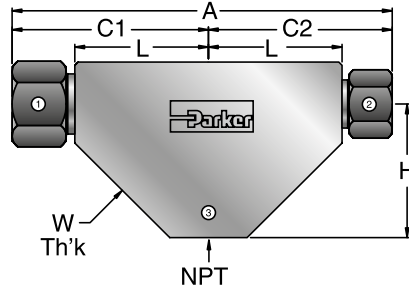

Parker Part No.	Inches									Working Pressure (PSIG)
	MPI™ Size #1	MPI™ Size #2	NPT Thread #3	A	C1	C2	C3	B	W Th'k	
4-4-4 OBMP7	1/4	1/4	1/4-18	3.47	1.74	1.74	1.24	1.24	3/4	15,000
6-6-4 OBMP7	3/8	3/8	1/4-18	3.72	1.86	1.86	1.24	1.24	3/4	15,000
6-6-8 OBMP7	3/8	3/8	1/2-14	3.88	1.94	1.94	1.54	1.31	1 3/8	15,000
8-8-8 OBMP7	1/2	1/2	1/2-14	4.45	2.22	2.22	1.94	1.54	1 3/8	15,000
9-9-8 OBMP7	9/16	9/16	1/2-14	4.57	2.29	2.29	1.94	1.54	1 3/8	15,000
12-12-8 OBMP7	3/4	3/4	1/2-14	5.64	2.82	2.82	1.94	1.94	1 3/8	15,000

Dimensions in inches are for reference only, subject to change.

KBMP7 MPI™ Union Cross

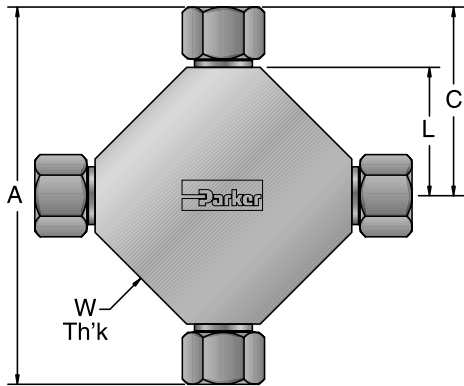

Parker Part No.	Inches					Working Pressure (PSIG)
	MPI™ Size	A	C	L	W Th'k	
4 KBMP7	1/4	3.06	1.53	1.03	5/8	15,000
6 KBMP7	3/8	3.72	1.86	1.24	3/4	15,000
8 KBMP7	1/2	4.45	2.22	1.54	1	15,000
9 KBMP7	9/16	4.57	2.29	1.54	1	15,000
12 KBMP7	3/4	5.64	2.82	1.94	1 3/8	15,000

Dimensions in inches are for reference only, subject to change.

Medium Pressure Instrument Fittings

MPI™ Medium Pressure Fittings

FNMP7 MPI™ Plug, Assembly

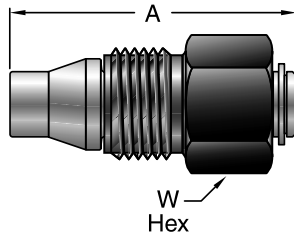

Parker Part No.	Inches			Working Pressure (PSIG)
	MPI™ Size	A	W Hex	
4 FNMP7	1/4	1.41	9/16	15,000
6 FNMP7	3/8	1.65	11/16	15,000
8 FNMP7	1/2	1.94	15/16	15,000
9 FNMP7	9/16	2.00	1	15,000
12 FNMP7	3/4	2.35	1 1/4	15,000
16 FNMP7	1	2.96	1 1/2	12,500

Assemble 1/4 to 1/2 turn from finger tight.
Dimensions in inches are for reference only, subject to change.

MPFF MPI™ Front Ferrule

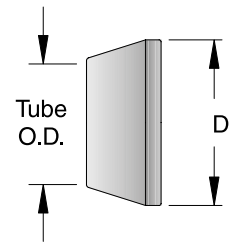

Parker Part No.	Tube O.D.	Ferrule O.D.
4 MPFF	1/4	0.40
6 MPFF	3/8	0.52
8 MPFF	1/2	0.72
9 MPFF	9/16	0.78
12 MPFF	3/4	0.99
16 MPFF	1	1.30

Dimensions in inches are for reference only, subject to change.

PNBMP7 MPI™ Cap

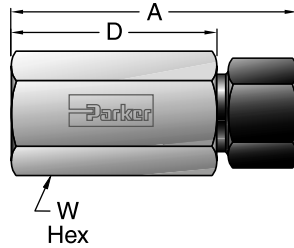

Parker Part No.	Inches				Working Pressure (PSIG)
	MPI™ Size	A	D	W Hex	
4 PNBMP7	1/4	1.69	1.19	5/8	15,000
6 PNBMP7	3/8	2.12	1.49	3/4	15,000
8 PNBMP7	1/2	2.62	1.93	1	15,000
9 PNBMP7	9/16	2.75	2.00	1 1/16	15,000
12 PNBMP7	3/4	3.53	2.64	1 3/8	15,000
16 PNBMP7	1	4.44	3.31	1 3/4	12,500

Dimensions in inches are for reference only, subject to change.

MPBF MPI™ Back Ferrule

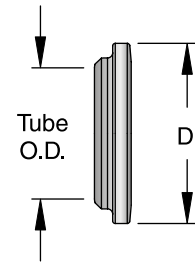

Parker Part No.	Tube O.D.	Ferrule O.D.
4 MPBF	1/4	0.40
6 MPBF	3/8	0.52
8 MPBF	1/2	0.72
9 MPBF	9/16	0.78
12 MPBF	3/4	0.99
16 MPBF	1	1.30

Dimensions in inches are for reference only, subject to change.

MPI™ Medium Pressure Fittings

BMP7 MPI™ Nut

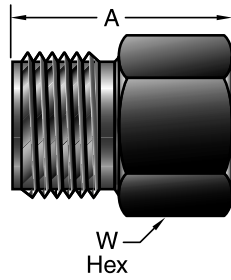

Parker Part No.	MPI™ Size	A	W Hex
4 BMP7	1/4	0.81	9/16
6 BMP7	3/8	0.92	11/16
8 BMP7	1/2	0.97	15/16
9 BMP7	9/16	1.03	1
12 BMP7	3/4	1.34	1 1/4
16 BMP7	1	1.74	1 1/2

Dimensions in inches are for reference only, subject to change.

Gaugeability Tools

Gap Gauge

This one handy gauge works for all MPI™ sizes. The end of the gauge checks the fitting gap after make-up. See page 203 for make-up and inspection instructions.



Gap Gauge

Size	Parker Part No.
1/4	4 MPI GAP Gauge
3/8	6 MPI GAP Gauge
1/2	8 MPI GAP Gauge
9/16	9 MPI GAP Gauge
3/4	12 MPI GAP Gauge
1	16 MPI GAP Gauge

MPI™ Medium Pressure Fittings

Assembly

1. Parker MPI™ Fittings are sold completely assembled and ready for immediate use. Simply insert the tube as illustrated until it bottoms in the fitting body. (If the fitting is disassembled, note that the small tapered end of the ferrule(s) go into the fitting body.)
2. Turn the nut to the “finger-tight” position. Hold the fitting body with a second wrench to prevent the body from turning as you tighten the nut. For hand assembly, tighten the nut 1-1/2 turns. For 3/4" and 1" sizes, preset the nut and ferrules and then tighten the nut 1/2 turn only. See page 204 for more information on preset connections. Parker recommends that you mark the nut (using a scribe or ink) to help you count the turns.

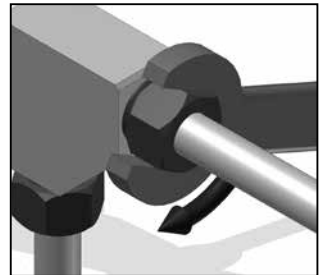
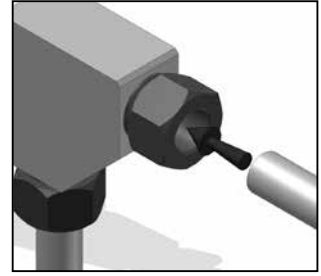

Gaugeability

Check the gap between the nut and the body hex with the end of the gauge by inserting the gauge (as shown) into the beveled gap between the nut and body hex. Gently turn the gauge (that is, it “twists out”). However, if the gauge slides into the beveled gap, (does not “twist out”) the fitting is not properly made up and you must check the entire assembly procedure.



Remake

For maximum number of remakes, mark the fitting and nut before disassembly. Before retightening, make sure the assembly has been inserted into the fitting until the ferrule seats in the fitting. Retighten the nut by hand. Rotate the nut with a wrench to the original position as indicated by the previous marks lining up. (A noticeable increase in mechanical resistance will be felt indicating the ferrule is being re-sprung into sealing position.)

MPI™ Medium Pressure Fittings

MPI™ Hydraulic Preset Tools

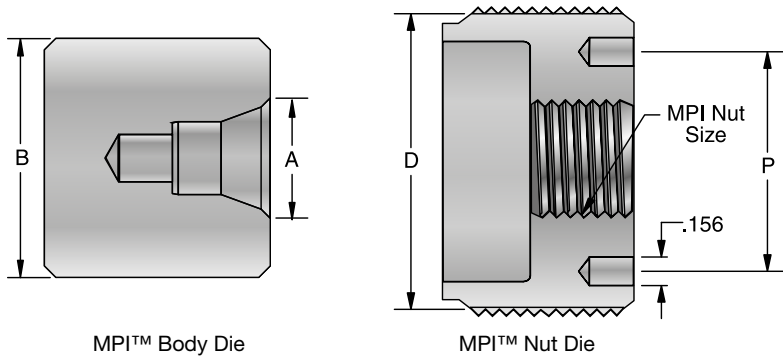

MPI™ Body Die

MPI™ Nut Die

Body Dies and Nut Dies Used with the MPI™ Small Preset Assembly

MPI Small Preset Assembly		Inches					Preset Pressure (PSIG)
Body Die Part No.	Nut Die Part No.	A	B	D	P	MPI™ Nut Size	
4 MPI Body Die	4 MPI Nut Die	.50	1.25	1.62	1.20	4	3,200
6 MPI Body Die	6 MPI Nut Die	.63	1.25	1.62	1.20	6	4,000
8 MPI Body Die	8 MPI Nut Die	.82	1.25	1.62	1.20	8	6,800
9 MPI Body Die	9 MPI Nut Die	.88	1.25	1.62	1.20	9	8,500

Dimensions in inches are for reference only, subject to change.

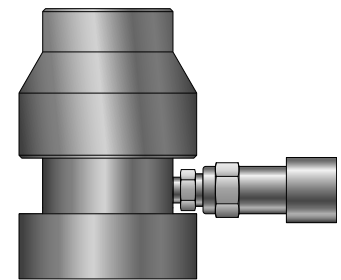

Parker Part No.
MPI SMALL Preset Assembly

Body Dies and Nut Dies Used with the MPI™ Large Preset Assembly

MPI Large Preset Assembly		Inches					Preset Pressure (PSIG)
Body Die Part No.	Nut Die Part No.	A	B	D	P	MPI™ Nut Size	
*9 MPI Body Die	9 MPI Large Nut Die	.88	1.25	2.00	1.67	9	3,600
12 MPI Body Die	12 MPI Nut Die	1.13	1.75	2.00	1.67	12	5,100
16 MPI Body Die	16 MPI Nut Die	1.44	1.75	2.00	1.67	16	8,000

* Requires a 9 MPI Body Die Adapter

Dimensions in inches are for reference only, subject to change.

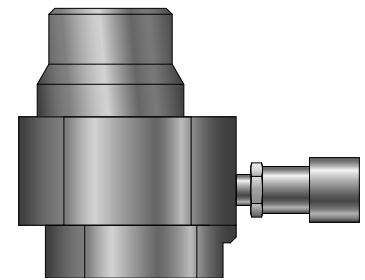

Parker Part No.
MPI LARGE Preset Assembly

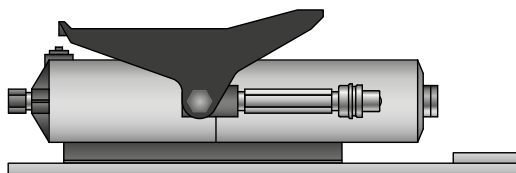

Parker Part No.
MPI AIR PUMP KIT

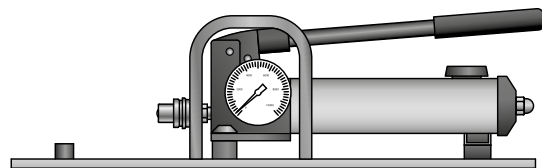

Parker Part No.
MPI HAND PUMP KIT

Note: One Pump Kit, Preset Assembly, Body Die and Nut Die are required for presetting. Pump Kits and Preset Assemblies can be interchanged but Body Dies and Nut Dies are for a specific Preset Assembly. Detailed operating instructions are included with each kit. Copies may also be obtained by contacting the Division.

Medium Pressure Instrument Fittings

Tube Fabricating Equipment

Tube Benders

Heavy-duty tube bender for 1/4" to 1/2" and 6mm to 12mm tube.



Roller dies reduce force and tube flattening.



Clearly visible degree marks for accurate bending.

LOCK/UNLOCK WITH A HALF TURN ROTATION

ROLL DIES FOR REDUCED FORCE



Features

- High quality bending performance on stainless steel, and other hard tubing such as steel and titanium.
- Two stage design allows for in-place bending from 90° to 180° without ever crossing handles. Lock/unlock with a half turn rotation of the bending handle.
- Extra long 16" (40 cm) handles increase leverage and roll dies in the bending form reduce force needed.
- Vice clamp built into bending form for extra stability.

Tube Fabricating Equipment



Specifications and How to Order

Tube O.D.	Bend Radius	Weight (Kg)	Part Number
Imperial			
1/4"	5/8"	0.76	PTB-4T
5/16"	15/16"	1.84	PTB-5T
3/8"	15/16"	1.84	PTB-6T
1/2"	1 1/2"	2.76	PTB-8T
Metric			
6 mm	16 mm	0.76	PTB-6M
8 mm	24 mm	1.84	PTB-8M
10 mm	24 mm	1.84	PTB-10M
12 mm	38 mm	2.76	PTB-12M

Tube Fabricating Equipment

Cutting & Deburring Tools

Screw Feed Tubing Cutter with X-CEL Features



X-CEL KNOB FOR QUICK CUTTING



Features

- A contoured frame allows for easy alignment while adjusting the cutter to make a cut.
- X-CEL Knob for quick and easy cutting.
- Specially designed stainless steel cutter wheel contains bearings in the hub, to decrease drag around the tube for a smoother cut.
- 6 (in PT-C) or 12 (in PT-CL) individual bearings replace traditional rollers. The bearings create a smoother cut, and allow for increased speed around the tube.

Specifications and How to Order

Tube O.D.		Weight (Kg)	Part Number
Imperial	Metric		
1/4" - 1 3/8"	6 - 35 mm	0.40	PT-C
1/4" - 2 5/8"	6 - 67 mm	0.68	PT-CL

Replacement wheel - Part number: PT-CS

Tube Fabricating Equipment

Deburrer

A quick twist of the wrist will deburr either the O.D. or the I.D. of the tube end.

Insert the tube into the convexed end of the deburrer for inside deburring and the opposite end for outside deburring. Rotate in either direction.



Features

- 45 cutting edges on interior cone allow for fast, clean, inner reaming and outer deburring/beveling of copper and stainless steel tubing.
- Hardened steel construction.
- Machined outer surface for ease of grip.

Specifications and How to Order

Tube O.D.		Weight (Kg)	Part Number
Imperial	Metric		
1/4" - 1 1/4"	6 - 30 mm	0.34	PT-D
1/2" - 2"	12 - 50 mm	0.56	PT-DL

Parker PTV Tru-Kut Sawing Vice

Features

- Hacksaw guide will accommodate tube, pipe and hose from sizes 3 (3/16" O.D.) to 32 (2" O.D.).
- Assures square cut-offs within $\pm 1^\circ$. Use a fine tooth hacksaw blade for smoother cuts.

How To Use

Mount in vice or bolt to bench. Clamp tubing, pipe or hose into the Tru-Kut vice and cut off; guide ensures accurate square cuts.

How to Order

Vice - Part number: PT-V

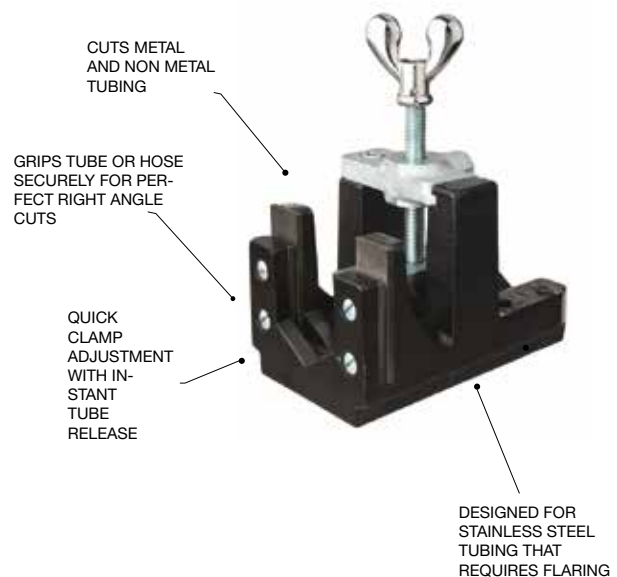

Tube Fabricating Equipment

Sealants

Parker PSL LOCTITE® 567™

A high performance sealant that locks and seals metal, tapered pipe threads and fittings. Ideal for stainless steel, aluminum, galvanized metal and other inert metals, 567™ has excellent solvent resistance and withstands temperatures to 204°C (400°F).



DESIGNED FOR THE LOCKING AND SEALING OF METAL TAPERED THREADS AND FITTINGS

Features

- High lubricating properties of this compound prevent galling on stainless steel, aluminum and all other metal pipe threads and fittings
- Recommended for industrial applications in the chemical processing, petroleum refining, pulp/paper, waste treatment, textile, utilities/power generation, marine, automotive, industrial equipment, gas compression and distribution industries.

Parker PSP Sealant

Sealing with Parker's solvent-free, liquid gasking compounds represents a technological advanced solution. Curing in the absence of air, which occurs after contact with metal, is the outstanding feature of anaerobic gasking compounds. As with any sealant and lubrication, safety precautions are always advised.

These sealants are available in 50ml and 200ml sizes.

EASY AND CLEAN APPLICATION



UNIQUE PARKER BRANDED SEALANT

TEMPERATURE RESISTANCE FROM -60°C TO +150°C

Features

- Quick-curing
- Solvent free
- One component sealant
- Serves to seal threaded connections, flanges, housings and covers
- Wide temperature range
- Resistant to chemicals and solvents

Tube Fabricating Equipment

Tube Fabricating Equipment

PTFE Tape

Polytetrafluoroethylene, or PTFE, film is cut to specified widths for use in sealing pipe threads. The tape is wrapped around the exposed threads of a pipe before it is screwed into place.

The tape is commonly used commercially in pressurised water systems as well as in air compression equipment and thread joints with coarse threads.

One of the defining characteristics of PTFE is how good it is at defeating friction. The use of PTFE tape in tapered pipe threads performs a lubricating function, which more easily allows the threads to be screwed together, to the point of deformation, which is what creates the seal.



Part Number: PS - PTFE

How to Order - Sealants

The correct part number is easily derived from the following number sequence. The three product characteristics required are coded as shown below.

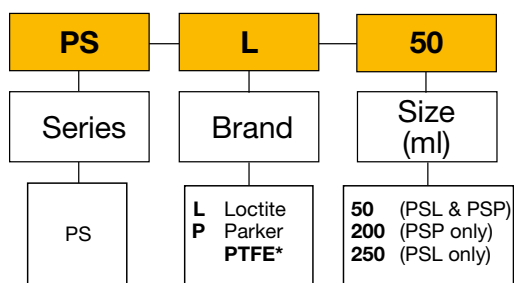

* No size required

Tube Fabricating Equipment

Gaugeability Tools

Parker PTM Tube Marker

This tube marker burnishes a mark on the tube quickly and accurately. This visible mark helps the installer ensure the correct depth of tube is inserted into the fitting body.

The tool can also be used to check the burnish mark position. The Tube Marker is available from 1/8" to 1" SAE sizes and from 6 mm to 25 mm Metric sizes.

Features/Benefits

- Compact, lightweight design
- Custom sized to tubing used
- Mark is burnished, not scribed on tube surface



How to Order

The correct part number is easily derived from the following number sequence.

The two product characteristics required are coded as shown below.

PTM	4T																												
Series	Size																												
PTM	<table border="1"> <tr> <td>2T</td> <td>1/8"</td> <td>6M</td> <td>6 mm</td> </tr> <tr> <td>4T</td> <td>1/4"</td> <td>8M</td> <td>8 mm</td> </tr> <tr> <td>6T</td> <td>3/8"</td> <td>10M</td> <td>10 mm</td> </tr> <tr> <td>8T</td> <td>1/2"</td> <td>12M</td> <td>12 mm</td> </tr> <tr> <td>10T</td> <td>5/8"</td> <td>16M</td> <td>16 mm</td> </tr> <tr> <td>12T</td> <td>3/4"</td> <td>20M</td> <td>20 mm</td> </tr> <tr> <td>16T</td> <td>1"</td> <td>25M</td> <td>25 mm</td> </tr> </table>	2T	1/8"	6M	6 mm	4T	1/4"	8M	8 mm	6T	3/8"	10M	10 mm	8T	1/2"	12M	12 mm	10T	5/8"	16M	16 mm	12T	3/4"	20M	20 mm	16T	1"	25M	25 mm
2T	1/8"	6M	6 mm																										
4T	1/4"	8M	8 mm																										
6T	3/8"	10M	10 mm																										
8T	1/2"	12M	12 mm																										
10T	5/8"	16M	16 mm																										
12T	3/4"	20M	20 mm																										
16T	1"	25M	25 mm																										

Parker PPT Preassembly Tool

Parker's Preassembly Tool is an easy-to-use manual tool to ensure the correct preassembly of compression tube fittings on instrumentation tubing. This preassembly will assist in proper initial make-up in tight installation spaces.

All preassembly tools have a wrench flat on the bottom so they can be easily mounted in a vice.

How to Use

Slide nut and ferrule(s) onto tube. Set the tube into presetting tool ensuring the tube is fully bottomed. Finger tighten the nut, then mark the nut at 6 o'clock position. Tighten the nut 1 turn with a wrench. Remove tube from tool.

Put assembly into the fitting body and tighten the nut to the 9 o'clock position therefore completing the 1-1/4 turns from the original 6 o'clock position.



How to Order

The correct part number is easily derived from the following number sequence.

The two product characteristics required are coded as shown below.

PPT	4T																																																
Series	Size																																																
PPT	<table border="1"> <tr> <td>2T</td> <td>1/8"</td> <td>3M</td> <td>3mm</td> </tr> <tr> <td>3T</td> <td>3/16"</td> <td>4M</td> <td>4mm</td> </tr> <tr> <td>4T</td> <td>1/4"</td> <td>6M</td> <td>6 mm</td> </tr> <tr> <td>5T</td> <td>5/16"</td> <td>8M</td> <td>8 mm</td> </tr> <tr> <td>6T</td> <td>3/8"</td> <td>10M</td> <td>10 mm</td> </tr> <tr> <td>8T</td> <td>1/2"</td> <td>12M</td> <td>12 mm</td> </tr> <tr> <td>10T</td> <td>5/8"</td> <td>14M</td> <td>14mm</td> </tr> <tr> <td>12T</td> <td>3/4"</td> <td>16M</td> <td>16mm</td> </tr> <tr> <td>14T</td> <td>7/8"</td> <td>18M</td> <td>18mm</td> </tr> <tr> <td>16T</td> <td>1"</td> <td>20M</td> <td>20mm</td> </tr> <tr> <td></td> <td></td> <td>22M</td> <td>22mm</td> </tr> <tr> <td></td> <td></td> <td>25M</td> <td>25mm</td> </tr> </table>	2T	1/8"	3M	3mm	3T	3/16"	4M	4mm	4T	1/4"	6M	6 mm	5T	5/16"	8M	8 mm	6T	3/8"	10M	10 mm	8T	1/2"	12M	12 mm	10T	5/8"	14M	14mm	12T	3/4"	16M	16mm	14T	7/8"	18M	18mm	16T	1"	20M	20mm			22M	22mm			25M	25mm
2T	1/8"	3M	3mm																																														
3T	3/16"	4M	4mm																																														
4T	1/4"	6M	6 mm																																														
5T	5/16"	8M	8 mm																																														
6T	3/8"	10M	10 mm																																														
8T	1/2"	12M	12 mm																																														
10T	5/8"	14M	14mm																																														
12T	3/4"	16M	16mm																																														
14T	7/8"	18M	18mm																																														
16T	1"	20M	20mm																																														
		22M	22mm																																														
		25M	25mm																																														

Tube Fabricating Equipment

Tube Fabricating Equipment

Parker PT Inspection Gauges

PT Combination Gauge

Using this unique Parker combination gauge together with the tube marker will guarantee precise and accurate tubing connections.

Use the No Go gap gauge to ensure that correct turns from finger tight have been achieved.

How to Use

Insert the gauge lip under the nut - the tube mark should be in line with the polished line on the tubing made by a marker. This proves that the tubing has remained fully bottomed through the installation process.

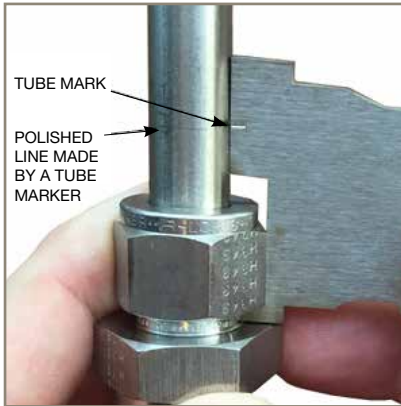

Correct verification of tube bottoming.

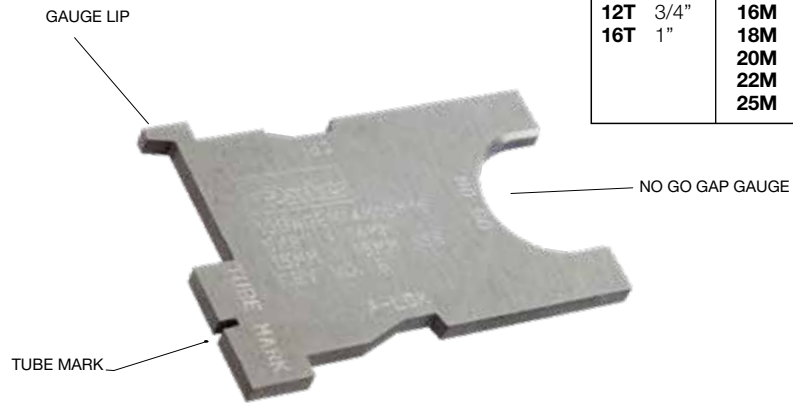

How to Order

The correct part number is easily derived from the following number sequence.

The three product characteristics required are coded as shown below.

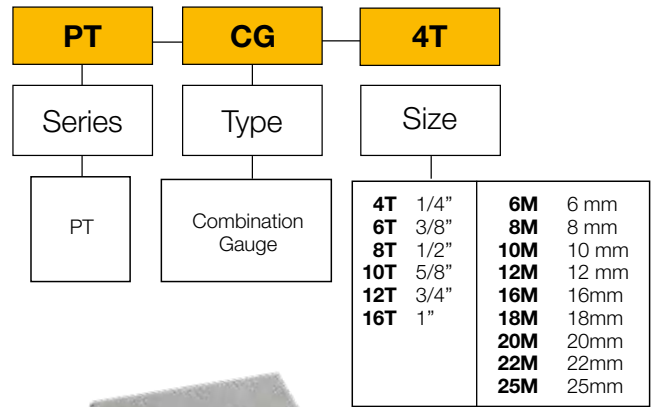

PT Gap Gauge

This compact C-Ring gap gauge is for imperial and metric sizes. It effectively checks the gap dimensions for correct initial make-up. All sizes can be combined on a key ring for easy handling.



How to Order

The correct part number is easily derived from the following number sequence.

The three product characteristics required are coded as shown below.

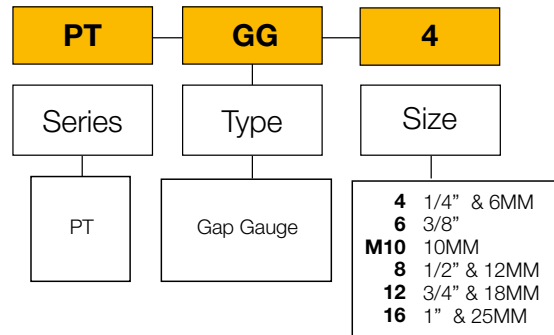

Tube Fabricating Equipment

Tube Fabricating Equipment

Parker IPD Ferrule Presetting Tool

Ferrule Presetting Components

Threads	Size	Part Numbers		Hy-Fer-Set Kit Components	
		Body Die	Nut Die	Item	Part No.
1/4"	4	4 Body Die	Size 4 Nut Die	Kit A Hydraulic Ram (size 4-16)	Hydraulic Ram
3/8"	6	6 Body Die	Size 6 Nut Die	Kit B Hydraulic Ram (size 20-32)	Hy-Fer-Set Body Assembly
1/2"	8	8 Body Die	Size 8 Nut Die	Hydraulic Hand Pump	Enerpac Pump P-392
5/8"	10	10 Body Die	Size 10 Nut Die	Hose Assembly	Hose Assembly w/guards
3/4"	12	12 Body Die	Size 12 Nut Die	Carrying Case	Carrying Case
7/8"	14	14 Body Die	Size 14 Nut Die		
1"	16	16 Body Die	Size 16 Nut Die		Size 16 Body Die Adapter
1-1/4"	20	20 Body Die	Size 20 Nut Die		
1-1/2"	24	24 Body Die	Size 24 Nut Die		
2"	32	32 Body Die	Size 32 Nut Die		

Note: To preset 1" with "B" tool, a size 16 body die adapter must be used

IPD Ferrule Presetting Tool Assembly Instructions

Coupler body in hydraulic ram and pump, is a high pressure, screw together coupler. Thread coupler body onto nipple and each end of hose assembly. No tools required.

Presetting CPI™ /A-LOK® Tube Fitting Ferrules Sizes 1/4" Through 1"

- Assemble CPI™/A-LOK® nut, CPI™/A-LOK® Ferrule(s) and body die onto tubing as shown in Figure 1. Be sure that the tapered end of the Ferrule(s) point toward the body die.
- Insert "U-shaped" Nut Die into the back-up plate of the Hydraulic Ram as shown in Figure 2.
- Insert Tube Assembly, Figure 1 into Nut Die as shown in Figure 3.
- Close the pressure relief valve on the side of the hand pump. Pump the hand pump until the ram reaches a positive stop. At this point an increase in resistance of the handle will be felt and the nut will bottom against the shoulder of the body die (Figure 4).
- Release the hydraulic pressure by opening the relief valve on the side of the pump. The ram will automatically return to the original position.
- The ferrule(s) are now preset on the tubing. Remove the preset assembly and pull the body die off the end of the tubing. (If the body die does not pull off by hand, clamp on the outside of the body die and move the tubing back and forth while pulling.) Do not clamp or pull on the preset ferrule(s) as this could damage a sealing surface.
- Insert the preset assembly into a fitting body, and make sure the ferrule seats in the fitting. Tighten the nut on the fitting body until finger tight.
- Tighten the nut with a wrench the additional amount shown in the table at the right for each connection size. (If an increase in torque is not felt early in wrench make-up the preset assembly was not properly seated.) If this happens, tighten the nut with a wrench until the torque increase is felt. Then, loosen nut to the finger tight position, tighten the nut the additional amount shown in the table.

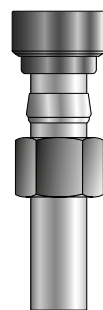

Figure 1

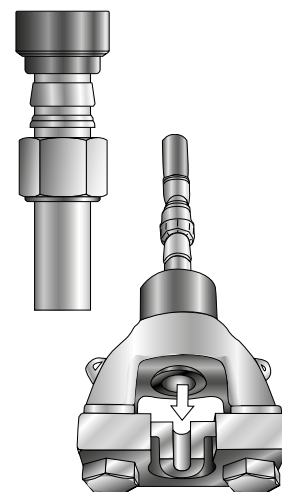

Figure 2

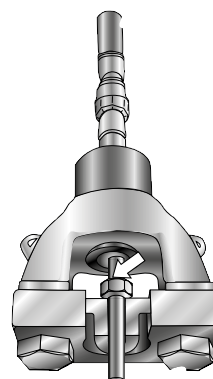

Figure 3

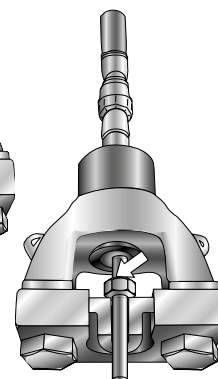

Figure 4

Size	Turns
4	1/2
6	1/2
8	1/2
10	1/2
12	1/2
14	1/2
16	1/2

Tube Fabricating Equipment

Parker IPD Ferrule Presetting Tool

Pre-setting the CPI™ Tube Fitting Ferrules Size 1-1/4", 1-1/2", and 2"

1. Assemble CPI™ nut, CPI™ Ferrule and body die onto tubing as shown in Figure 5. Be sure that the tapered end of the ferrule point toward the body die.
2. Insert "U-shaped" Nut die into the Nut Die Adapter of the Hydraulic Ram as shown in Figure 6.
NOTE: For size 32 the nut die adapter is not needed and must be removed before inserting the nut die.
3. Insert Tube Assembly, Figure 5, into Nut Die as shown in Figure 7.
4. Close the pressure relief valve on the side of the hand pump. Pump the hand pump until the ram reaches a positive stop. At this point an increase in resistance of the handle will be felt and the nut will bottom against the shoulder of the body die Figure 8.
5. Release the hydraulic pressure by opening the relief valve on the side of the pump. The ram will automatically return to the original position.
6. The ferrule(s) are now preset on the tubing. Remove the preset assembly and pull the body die off the end of the tubing. (If the body die does not pull off by hand, clamp on the outside of the body die and move the tubing back and forth while pulling.) Do not clamp or pull on the preset ferrule(s) as this could damage a sealing surface.
7. Insert the preset assembly into a fitting body, and make sure the ferrule seats in the fitting. Tighten the nut on the fitting body until finger tight.
8. Tighten nut with a wrench the additional amount shown in the table at the right for each connection size. If an increase in torque is not felt early in wrench make up the preset assembly was not properly seated. If this happens, tighten the nut with a wrench until torque increase is felt. Then, loosen nut to the finger tight position, tighten nut the additional amount shown in the table.

Size	Turns
20	5/8
24	5/8
32	3/4

PLEASE NOTE: Pressure ratings for all Parker Hannifin instrumentation fittings are different because tubing thickness can vary widely. All instrumentation fittings are designed so the tubing is always weaker than the fitting. Thus the pressure rating of the fitting is contingent on the pressure rating of the associated tubing.

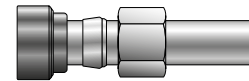

Figure 5

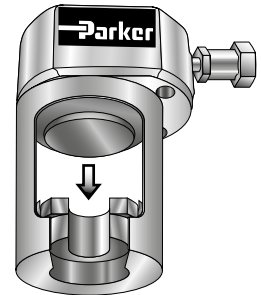

Figure 6

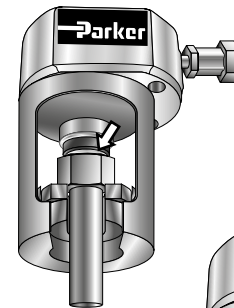

Figure 7

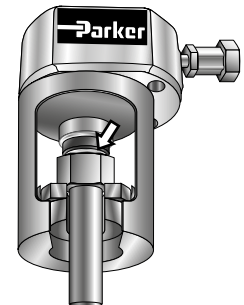
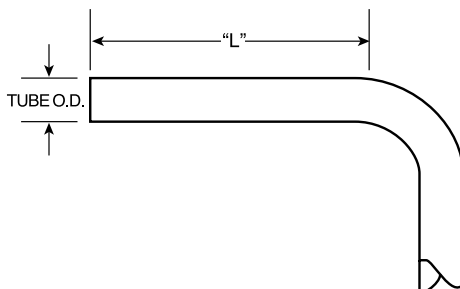

Figure 8

Minimum Tubing Lengths



Note: You will need a minimum straight length of tubing ahead of any bend to fit into the presetting tool. See the "L" dimension in the chart for each tube O.D. size.

"L" Dimensions

Tube O.D. (inches)	"L" (inches)
1/4	2
3/8	2-1/8
1/2	2-3/8
5/8	2-3/8
3/4	2-3/8
7/8	2-1/2
1	2-5/8
1-1/4	3
1-1/2	3-3/8
2	4-1/4

Complementary Products

Lapped Joint Tube Adaptors (LJ)

For applications involving small flanged process valves with simple conversion to instrument lines.



Specification

- 1/2" to 2" N.B. flanges (15 to 50DN).
- 150 to 2500lb flange class.
- Flange sealing:- Raised face spiral finish.
- Standard A-LOK® arrangement 1/4" to 1" O.D. (3mm to 25mm O.D.).
- Standard CPI™ arrangement 1/4" to 1" O.D. (3mm to 25mm O.D.).
- Standard stainless steel body (316).
- Other materials on application.

Features

- Full heat code traceability to EN10204-3.1.
- Integrally machined body, no welding.
- Eliminates additional connections.
- P.T.F.E tape or liquid thread sealants not required.
- Appropriate slipover flanges available.
- NACE MR 0175 / ISO 15156.
- compliance available on request.

Part number construction

	Series	Material (refer to table on page 218)	Connection A-LOK maximum size 1" / 25mm	Flange size	Class (to be specified when slipovers required)	Optional slipover flanges
Example 1	LJF	B	8A	8	600	SF
Example 2	LJF	D	M6A	12		

For CPI™ change A to Z.

For A-LOK® size codes see page 218 .

Example 1: LJFB8A8600SF - Stainless steel, 1/2" O.D. A-LOK® tube connection to 1/2" (DN15) pipe flange, supplied with Class 600 slipover flange.

Example 2: LJFDM6A12 - Monel M400, 6mm O.D. A-LOK® tube connection to 3/4" (DN20) pipe flange. Flange class must be specified when ordering slipover flange options.

A-LOK®/CPI products in Carbon Steel and Low temp
Carbon Steel will be supplied with 316 nuts and ferrules

A-LOK®/CPI products can not be offered in the following materials:

E: Duplex UNS 31803

F: Super Duplex UNS.S.32750

Flange to Compression Connectors (FC)

One piece integral connectors allow the user to switch from piping flange standards to instrument compression with minimum cost and added safety. This system eliminates the need for additional connections while also eliminating the need for welding or pipe threads.



Specification

- 1/2" to 2" N.B. flanges (15 to 50DN).
- 150 to 2500lb flange class.
- Flanges to ANSI B16.5. (others available on request)
- Standard or inverted A-LOK® arrangements 1/4" to 1" O.D. (3mm to 25mm O.D.).
- Standard or inverted CPI™ arrangements 1/4" to 1" O.D. (3mm to 25mm O.D.).
- Flange sealing:-
Raised face spiral finish.
Ring type joint.
- Standard stainless steel body (316).
- Other materials on application

Features

- Full heat code traceability to EN10204-3.1
- Integrally machined body, no welding.
- Eliminates additional connections.
- P.T.F.E tape or liquid thread sealants not required.
- Variety of materials available.
- NACE MR 0175 / ISO 15156 compliance available on request.

Part number construction

	Series	Material (refer to table on page 218)	Connection	Flange Size	Face Style	Class
Example 1	FC	B	8A	16	F	600
Example 2	FC	K	M12A	8	T	1500

For CPI™ change A to Z.

For A-LOK® size codes see page 218.

Example 1: FCB8A16F600 - Stainless steel, 1/2" O.D. A-LOK® tube connection, 1" pipe flange, raised face, class 600.

Example 2: FCKM12A8T1500 - 6Mo, 12mm O.D. A-LOK® tube connection to 1/2" pipe flange, ring type joint, class 1500.

Kidney Flanges to Compression Connectors (KF)

Integral A-LOK® twin ferrule connection for simple, easy and safe connection from process measurement impulse line to instrument or manifold.



Specification

- Rated to 6000psi. Max (depending on connection)
- Standard PTFE seal ring.
- Optional Graphite available.
- Standard stainless steel body (316).
- Standard A-LOK® arrangement 1/4" to 1/2" (3mm to 12mm).
- Standard CPI™ arrangement 1/4" to 1/2" (3mm to 12mm).
- Standard stainless steel body (316).
- Other materials on application.

Features

- High tensile steel bolts standard.
- Full heat code traceability to EN10204-3.1
- 1/2" NB Sch.40 to Sch XXS butt weld connections available.
- Offset threads available.
- Integrally machined body, no welding.
- Eliminates additional connections.
- P.T.F.E tape or liquid thread sealants not required.
- NACE MR 0175 / ISO 15156 compliance available on request.

Part number construction

	Series	Material (refer to table on page 218)	Connection A-lok maximum size 1" / 25mm	Flange size	Face Style	Class
Example 1	FC	B	8A	16	F	600
Example 2	FC	K	M12A	8	T	1500

For CPI™ change A to Z.

For A-LOK® size codes see page 218.

Example 1: KFB8A3 - Stainless steel, 1/2" O.D. A-LOK® tube connection, graphite sealing ring, 2 carbon steel bolts.

Example 2: KFB8FSSBN - Stainless steel, 1/2" Female NPT thread, P.T.F.E. sealing ring, 2 stainless steel bolts, complies to NACE.

Swivel Gauge Adaptors

Parker's range of swivel gauge adaptors have been designed to provide 360° rotational movement enabling maximum positional orientation of installed gauges and measuring instruments. A fully contained sealing mechanism ensured total system integrity and offers the user up to 10,000 psig (690 barg) working pressure.

Silver plated swivel nut thread and bearing area prevent thread galling of stainless steel threads and allow trouble free repeatable re-assembly.



Specifications

- 316 Stainless steel standard.
- 1/2" NPT male to 1/2" NPT female standard.
- 6,000 psig (414 barg) maximum pressure rating.
- Maximum temperature rating 260°C (500°F).
- Fully heat code traceable.
- Height = 66mm (2.60").
- A/F1 = 19mm (3/4").
- A/F2 = 31.8mm (1 1/4").

Features

- Silver plated swivel thread and bearing surface to prevent thread galling and maximising re-make opportunities.
- Variety of thread options.
- Compact design.
- Fully contained and retained sealing mechanism.

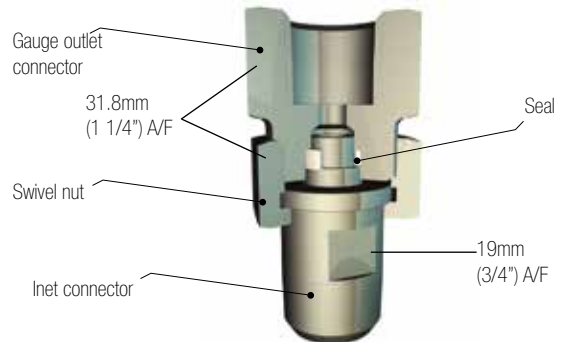

Part number construction

	Series	Material (refer to table on page 218)	Inlet connection NPT standard	Outlet connection NPT standard	Graphoil option (3)	High pressure option (HP)	NACE optional (N)
Example 1	SG	B	8M	8F	3	HP	-
Example 2	SG	B	6M	8F			N

For male outlet change F to M.

For BSPP suffix M and/or F with R.

For BSPT suffix M and/or F with K.

For DIN 16288 spigot seal suffix F with RDIN.

Example 1: Stainless steel 1/2" NPT male inlet, 1/2" NPT female outlet, with graphoil seal and 10,000 psi (689 bar) rating.

Example 2: Stainless steel 3/8" NPT male inlet, 1/2" NPT female outlet, with P.T.F.E. (standard) and in accordance with NACE requirements.

Material	
A	Carbon Steel
B	Stainless Steel
D	Monel M400
E	Duplex UNS 31803
F	Super Duplex UNS S.32750
G	Hastelloy C-276
H	Low Temp. C. St. A350 LF2
K	6Mo
L	825
M	Inconel 625

A-LOK® size codes

Designator	Fractional Size
1	1/16"
2	1/8"
3	3/16"
4	1/4"
5	5/16"
6	3/8"
8	1/2"
10	5/8"
12	3/4"
14	7/8"
16	1"
20	1-1/4"
24	1-1/2"
32	2"

Designator	Metric Size
M2	2
M3	3
M4	4
M6	6
M8	8
M10	10
M12	12
M14	14
M15	15
M16	16
M18	18
M20	20
M22	22
M25	25
M28	28
M30	30
M32	32

Notes

Notes



WARNING USER RESPONSIBILITY

FAILURE OR IMPROPER SELECTION OR IMPROPER USE OF THE PRODUCTS DESCRIBED HEREIN OR RELATED ITEMS CAN CAUSE DEATH, PERSONAL INJURY AND PROPERTY DAMAGE.

This document and other information from Parker Hannifin Corporation, its subsidiaries and authorized distributors provide product or system options for further investigation by users having technical expertise.

The user, through its own analysis and testing, is solely responsible for making the final selection of the system and components and assuring that all performance, endurance, maintenance, safety and warning requirements of the application are met. The user must analyze all aspects of the application, follow applicable industry standards, and follow the information concerning the product in the current product catalog and in any other materials provided from Parker or its subsidiaries or authorized distributors.

To the extent that Parker or its subsidiaries or authorized distributors provide component or system options based upon data or specifications provided by the user, the user is responsible for determining that such data and specifications are suitable and sufficient for all applications and reasonably foreseeable uses of the components or systems.

Offer of Sale

The items described in this document and other documents and descriptions provided by Parker Hannifin Corporation, its subsidiaries and its authorized distributors ("Seller") are hereby offered for sale at prices to be established by Seller. This offer and its acceptance by any customer ("Buyer") shall be governed by all of the following Terms and Conditions. Buyer's order for any item described in its document, when communicated to Seller verbally, or in writing, shall constitute acceptance of this offer. All goods or work described will be referred to as "Products".

1. Terms and Conditions. Seller's willingness to offer Products, or accept an order for Products, to or from Buyer is expressly conditioned on Buyer's assent to these Terms and Conditions and to the terms and conditions found on-line at www.parker.com/saleterms/. Seller objects to any contrary or additional term or condition of Buyer's order or any other document issued by Buyer.

2. Price Adjustments; Payments. Prices stated on the reverse side or preceding pages of this document are valid for 30 days. After 30 days, Seller may change prices to reflect any increase in its costs resulting from state, federal or local legislation, price increases from its suppliers, or any change in the rate, charge, or classification of any carrier. The prices stated on the reverse or preceding pages of this document do not include any sales, use, or other taxes unless so stated specifically. Unless otherwise specified by Seller, all prices are F.O.B. Seller's facility, and payment is due 30 days from the date of invoice. After 30 days, Buyer shall pay interest on any unpaid invoices at the rate of 1.5% per month or the maximum allowable rate under applicable law.

3. Delivery Dates; Title and Risk; Shipment. All delivery dates are approximate and Seller shall not be responsible for any damages resulting from any delay. Regardless of the manner of shipment, title to any products and risk of loss or damage shall pass to Buyer upon tender to the carrier at Seller's facility (i.e., when it's on the truck, it's yours). Unless otherwise stated, Seller may exercise its judgment in choosing the carrier and means of delivery. No deferment of shipment at Buyers' request beyond the respective dates indicated will be made except on terms that will indemnify, defend and hold Seller harmless against all loss and additional expense. Buyer shall be responsible for any additional shipping charges incurred by Seller due to Buyer's changes in shipping, product specifications or in accordance with Section 13, herein.

4. Warranty. Seller warrants that the Products sold hereunder shall be free from defects in material or workmanship for a period of twelve months from the date of delivery to Buyer or 2,000 hours of normal use, whichever occurs first. This warranty is made only to Buyer and does not extend to anyone to whom Products are sold after purchased from Seller. The prices charged for Seller's products are based upon the exclusive limited warranty stated above, and upon the following disclaimer: **DISCLAIMER OF WARRANTY: THIS WARRANTY COMPRISES THE SOLE AND ENTIRE WARRANTY PERTAINING TO PRODUCTS PROVIDED HEREUNDER. SELLER DISCLAIMS ALL OTHER WARRANTIES, EXPRESS AND IMPLIED, INCLUDING MERCHANTABILITY AND FITNESS FOR A PARTICULAR PURPOSE.**

5. Claims; Commencement of Actions. Buyer shall promptly inspect all Products upon delivery. No claims for shortages will be allowed unless reported to the Seller within 10 days of delivery.

No other claims against Seller will be allowed unless asserted in writing within 60 days after delivery or, in the case of an alleged breach of warranty, within 30 days after the date within the warranty period on which the defect is or should have been discovered by Buyer. Any action based upon breach of this agreement or upon any other claim arising out of this sale (other than an action by Seller for any amount due to Seller from Buyer) must be commenced within thirteen months from the date of tender of delivery by Seller or, for a cause of action based upon an alleged breach of warranty, within thirteen months from the date within the warranty period on which the defect is or should have been discovered by Buyer.

6. LIMITATION OF LIABILITY. UPON NOTIFICATION, SELLER WILL, AT ITS OPTION, REPAIR OR REPLACE A DEFECTIVE PRODUCT, OR REFUND THE PURCHASE PRICE. IN NO EVENT SHALL SELLER BE LIABLE TO BUYER FOR ANY SPECIAL, INDIRECT, INCIDENTAL OR CONSEQUENTIAL DAMAGES ARISING OUT OF, OR AS THE RESULT OF, THE SALE, DELIVERY, NON-DELIVERY, SERVICING, USE OR LOSS OF USE OF THE PRODUCTS OR ANY PART THEREOF, OR FOR ANY CHARGES OR EXPENSES OF ANY NATURE INCURRED WITHOUT SELLER'S WRITTEN CONSENT, EVEN IF SELLER HAS BEEN NEGLIGENT, WHETHER IN CONTRACT, TORT OR OTHER LEGAL THEORY. IN NO EVENT SHALL SELLER'S LIABILITY UNDER ANY CLAIM MADE BY BUYER EXCEED THE PURCHASE PRICE OF THE PRODUCTS.

7. Contingencies. Seller shall not be liable for any default or delay in performance if caused by circumstances beyond the reasonable control of Seller.

8. User Responsibility. The user, through its own analysis and testing, is solely responsible for making the final selection of the system and Product and assuring that all performance, endurance, maintenance, safety and warning requirements of the application are met. The user must analyze all aspects of the application and follow applicable industry standards and Product information. If Seller provides Product or system options, the user is responsible for determining that such data and specifications are suitable and sufficient for all applications and reasonably foreseeable uses of the Products or systems.

9. Loss to Buyer's Property. Any designs, tools, patterns, materials, drawings, confidential information or equipment furnished by Buyer or any other items which become Buyer's property, may be considered obsolete and may be destroyed by Seller after two consecutive years have elapsed without Buyer placing an order for the items which are manufactured using such property. Seller shall not be responsible for any loss or damage to such property while it is in Seller's possession or control.

10. Special Tooling. A tooling charge may be imposed for any special tooling, including without limitation, dies, fixtures, molds and patterns, acquired to manufacture Products.

Such special tooling shall be and remain Seller's property notwithstanding payment of any charges by Buyer. In no event will Buyer acquire any interest in apparatus belonging to Seller which is utilized in the manufacture of the Products, even if such apparatus has been specially converted or adapted for such manufacture and notwithstanding any charges paid by Buyer. Unless otherwise agreed, Seller shall have the right to alter, discard or otherwise dispose of any special tooling or other property in its sole discretion at any time.

11. Buyer's Obligation; Rights of Seller. To secure payment of all sums due or otherwise, Seller shall retain a security interest in the goods delivered and this agreement shall be deemed a Security Agreement under the Uniform Commercial Code. Buyer authorizes Seller as its attorney to execute and file on Buyer's behalf all documents Seller deems necessary to perfect its security interest. Seller shall have a security interest in, and lien upon, any property of Buyer in Seller's possession as security for the payment of any amounts owed to Seller by Buyer.

12. Improper use and Indemnity. Buyer shall indemnify, defend, and hold Seller harmless from any claim, liability, damages, lawsuits, and costs (including attorney fees), whether for personal injury, property damage, patent, trademark or copyright infringement or any other claim, brought by or incurred by Buyer, Buyer's employees, or any other person, arising out of: (a) improper selection, improper application or other misuse of Products purchased by Buyer from Seller; (b) any act or omission, negligent or otherwise, of Buyer; (c) Seller's use of patterns, plans, drawings, or specifications furnished by Buyer to manufacture Product; or (d) Buyer's failure to comply with these terms and conditions. Seller shall not indemnify Buyer under any circumstance except as otherwise provided.

13. Cancellations and Changes. Orders shall not be subject to cancellation or change by Buyer for any reason, except with Seller's written consent and upon terms that will indemnify, defend and hold Seller harmless against all direct, incidental and consequential loss or damage. Seller may change product features, specifications, designs and availability with notice to Buyer.

14. Limitation on Assignment. Buyer may not assign its rights or obligations under this agreement without the prior written consent of Seller.

15. Entire Agreement. This agreement contains the entire agreement between the Buyer and Seller and constitutes the final, complete and exclusive expression of the terms of the agreement. All prior or contemporaneous written or oral agreements or negotiations with respect to the subject matter are herein merged.

16. Waiver and Severability. Failure to enforce any provision of this agreement will not waive that provision nor will any such failure prejudice Seller's right to enforce that provision in the future. Invalidation of any provision of this agreement by legislation or other rule of law shall not invalidate any other provision herein. The remaining provisions of this agreement will remain in full force and effect.

17. Termination. This agreement may be terminated by Seller for any reason and at any time by giving Buyer thirty (30) days written notice of termination. In addition, Seller may

by written notice immediately terminate this agreement for the following: (a) Buyer commits a breach of any provision of this agreement (b) the appointment of a trustee, receiver or custodian for all or any part of Buyer's property (c) the filing of a petition for relief in bankruptcy of the other Party on its own behalf, or by a third party (d) an assignment for the benefit of creditors, or (e) the dissolution or liquidation of the Buyer.

18. Governing Law. This agreement and the sale and delivery of all Products hereunder shall be deemed to have taken place in and shall be governed and construed in accordance with the laws of the State of Ohio, as applicable to contracts executed and wholly performed therein and without regard to conflicts of laws principles. Buyer irrevocably agrees and consents to the exclusive jurisdiction and venue of the courts of Cuyahoga County, Ohio with respect to any dispute, controversy or claim arising out of or relating to this agreement. Disputes between the parties shall not be settled by arbitration unless, after a dispute has arisen, both parties expressly agree in writing to arbitrate the dispute.

19. Indemnity for Infringement of Intellectual Property Rights. Seller shall have no liability for infringement of any patents, trademarks, copyrights, trade dress, trade secrets or similar rights except as provided in this Section. Seller will defend and indemnify Buyer against allegations of infringement of U.S. patents, U.S. trademarks, copyrights, trade dress and trade secrets ("Intellectual Property Rights"). Seller will defend at its expense and will pay the cost of any settlement or damages awarded in an action brought against Buyer based on an allegation that a Product sold pursuant to this Agreement infringes the Intellectual Property Rights of a third party. Seller's obligation to defend and indemnify Buyer is contingent on Buyer notifying Seller within ten (10) days after Buyer becomes aware of such allegations of infringement, and Seller having sole control over the defense of any allegations or actions including all negotiations for settlement or compromise. If a Product is subject to a claim that it infringes the Intellectual Property Rights of a third party, Seller may, at its sole expense and option, procure for Buyer the right to continue using the Product, replace or modify the Product so as to make it noninfringing, or offer to accept return of the Product and return the purchase price less a reasonable allowance for depreciation. Notwithstanding the foregoing, Seller shall have no liability for claims of infringement based on information provided by Buyer, or directed to Products delivered hereunder for which the designs are specified in whole or part by Buyer, or infringements resulting from the modification, combination or use in a system of any Product sold hereunder. The foregoing provisions of this Section shall constitute Seller's sole and exclusive liability and Buyer's sole and exclusive remedy for infringement of Intellectual Property Rights.

20. Taxes. Unless otherwise indicated, all prices and charges are exclusive of excise, sales, use, property, occupational or like taxes which may be imposed by any taxing authority upon the manufacture, sale or delivery of Products.

21. Equal Opportunity Clause. For the performance of government contracts and where dollar value of the Products exceed \$10,000, the equal employment opportunity clauses in Executive Order 11246, VEVRAA, and 41 C.F.R. §§ 60-1.4(a), 60-741.5(a), and 60-250.4, are hereby incorporated.

Parker Worldwide

Europe, Middle East, Africa

AE – United Arab Emirates, Dubai

Tel: +971 4 8127100
parker.me@parker.com

AT – Austria, Wiener Neustadt

Tel: +43 (0)2622 23501-0
parker.austria@parker.com

AT – Eastern Europe, Wiener Neustadt

Tel: +43 (0)2622 23501 900
parker.easteurope@parker.com

AZ – Azerbaijan, Baku

Tel: +994 50 2233 458
parker.azerbaijan@parker.com

BE/LU – Belgium, Nivelles

Tel: +32 (0)67 280 900
parker.belgium@parker.com

BG – Bulgaria, Sofia

Tel: +359 2 980 1344
parker.bulgaria@parker.com

BY – Belarus, Minsk

Tel: +48 (0)22 573 24 00
parker.poland@parker.com

CH – Switzerland, Etoy

Tel: +41 (0)21 821 87 00
parker.switzerland@parker.com

CZ – Czech Republic, Klecany

Tel: +420 284 083 111
parker.czechrepublic@parker.com

DE – Germany, Kaarst

Tel: +49 (0)2131 4016 0
parker.germany@parker.com

DK – Denmark, Ballerup

Tel: +45 43 56 04 00
parker.denmark@parker.com

ES – Spain, Madrid

Tel: +34 902 330 001
parker.spain@parker.com

FI – Finland, Vantaa

Tel: +358 (0)20 753 2500
parker.finland@parker.com

FR – France, Contamine s/Arve

Tel: +33 (0)4 50 25 80 25
parker.france@parker.com

GR – Greece, Athens

Tel: +30 210 933 6450
parker.greece@parker.com

HU – Hungary, Budaörs

Tel: +36 23 885 470
parker.hungary@parker.com

IE – Ireland, Dublin

Tel: +353 (0)1 466 6370
parker.ireland@parker.com

IL – Israel

Tel: +39 02 45 19 21
parker.israel@parker.com

IT – Italy, Corsico (MI)

Tel: +39 02 45 19 21
parker.italy@parker.com

KZ – Kazakhstan, Almaty

Tel: +7 7273 561 000
parker.easteurope@parker.com

NL – The Netherlands, Oldenzaal

Tel: +31 (0)541 585 000
parker.nl@parker.com

NO – Norway, Asker

Tel: +47 66 75 34 00
parker.norway@parker.com

PL – Poland, Warsaw

Tel: +48 (0)22 573 24 00
parker.poland@parker.com

PT – Portugal

Tel: +351 22 999 7360
parker.portugal@parker.com

RO – Romania, Bucharest

Tel: +40 21 252 1382
parker.romania@parker.com

RU – Russia, Moscow

Tel: +7 495 645-2156
parker.russia@parker.com

SE – Sweden, Spånga

Tel: +46 (0)8 59 79 50 00
parker.sweden@parker.com

SK – Slovakia, Banská Bystrica

Tel: +421 484 162 252
parker.slovakia@parker.com

SL – Slovenia, Novo Mesto

Tel: +386 7 337 6650
parker.slovenia@parker.com

TR – Turkey, Istanbul

Tel: +90 216 4997081
parker.turkey@parker.com

UA – Ukraine, Kiev

Tel: +48 (0)22 573 24 00
parker.poland@parker.com

UK – United Kingdom, Warwick

Tel: +44 (0)1926 317 878
parker.uk@parker.com

ZA – South Africa, Kempton Park

Tel: +27 (0)11 961 0700
parker.southafrica@parker.com

North America

CA – Canada, Milton, Ontario

Tel: +1 905 693 3000

US – USA, Cleveland

Tel: +1 216 896 3000

Asia Pacific

AU – Australia, Castle Hill

Tel: +61 (0)2-9634 7777

CN – China, Shanghai

Tel: +86 21 2899 5000

HK – Hong Kong

Tel: +852 2428 8008

IN – India, Mumbai

Tel: +91 22 6513 7081-85

JP – Japan, Tokyo

Tel: +81 (0)3 6408 3901

KR – South Korea, Seoul

Tel: +82 2 559 0400

MY – Malaysia, Shah Alam

Tel: +60 3 7849 0800

NZ – New Zealand, Mt Wellington

Tel: +64 9 574 1744

SG – Singapore

Tel: +65 6887 6300

TH – Thailand, Bangkok

Tel: +662 186 7000

TW – Taiwan, Taipei

Tel: +886 2 2298 8987

South America

AR – Argentina, Buenos Aires

Tel: +54 3327 44 4129

BR – Brazil, Sao Jose dos Campos

Tel: +55 800 727 5374

CL – Chile, Santiago

Tel: +56 2 623 1216

MX – Mexico, Toluca

Tel: +52 72 2275 4200

© 2021 Parker Hannifin Corporation. All rights reserved.

08/21 Catalogue 4190-FMTG

Parker Hannifin Manufacturing Ltd.

Instrumentation Products Division,
Europe
Pottington Business Park
Barnstaple, EX31 1NP
United Kingdom
Tel.: +44 (0) 1271 31 31 31
www.parker.com/ipd

Parker Hannifin Corporation

Instrumentation Products Division
1005 A Cleaner Way
Huntsville
AL 358050
United States of America
Tel.: +1 (256) 881 2040
www.parker.com/ipd

EMEA Product Information Centre

Free phone: 00 800 27 27 5374
(from AT, BE, CH, CZ, DE, DK, EE, ES, FI, FR, IE, IL, IS, IT, LU, MT, NL, NO, PL, PT, RU, SE, SK, UK, ZA)
US Product Information Centre
Toll-free number: 1-800-27 27 537
www.parker.com

GOODYEAR
RUBBER PRODUCTS, INC.

727-342-5088

You can also email us at
GRP@goodyearrubberproducts.com