



Parker Legris: Connecting You to the Best in Technology

Catalog 3500LEG | October 2021



ENGINEERING YOUR SUCCESS

GOODYEAR
RUBBER PRODUCTS, INC.

727-342-5088

You can also email us at
GRP@goodyearrubberproducts.com



OTSEGO, MICHIGAN



TIJUANA, MEXICO



ALBION, INDIANA



LAKEVIEW, MICHIGAN



MESA, ARIZONA

WARNING – USER RESPONSIBILITY

FAILURE OR IMPROPER SELECTION OR IMPROPER USE OF THE PRODUCTS DESCRIBED HEREIN OR RELATED ITEMS CAN CAUSE DEATH, PERSONAL INJURY AND PROPERTY DAMAGE.

This document and other information from Parker-Hannifin Corporation, its subsidiaries and authorized distributors provide product or system options for further investigation by users having technical expertise.

The user, through its own analysis and testing, is solely responsible for making the final selection of the system and components and assuring that all performance, endurance, maintenance, safety and warning requirements of the application are met. The user must analyze all aspects of the application, follow applicable industry standards, and follow the information concerning the product in the current product catalog and in any other materials provided from Parker or its subsidiaries or authorized distributors.

To the extent that Parker or its subsidiaries or authorized distributors provide component or system options based upon data or specifications provided by the user, the user is responsible for determining that such data and specifications are suitable and sufficient for all applications and reasonably foreseeable uses of the components or systems.

Offer of Sale

The items described in this document are hereby offered for sale by Parker Hannifin Corporation, its subsidiaries or its authorized distributors. This offer and its acceptance are governed by the provisions stated on the separate page of this document entitled "Offer of Sale".

Safe Drinking Water Act

In accordance with 42 USC § 300g-6, parts in this catalog are to be used exclusively for nonpotable services such as manufacturing, industrial processing, irrigation, outdoor watering, or any other uses where the water is not anticipated to be used for human consumption. The only exceptions are parts described explicitly as "low lead" or suitable for potable water.

© Copyright 2019, Parker Hannifin Corporation. All Rights Reserved.

GOODYEAR
RUBBER PRODUCTS, INC.

 **727-342-5088**

You can also email us at
GRP@goodyearrubberproducts.com

Directives and Regulations: the Parker Legris Offer

Parker Legris complies with the directives and regulations listed below and goes beyond its statutory obligations for the ranges in question.



European RoHS directives: 2015/863

Relating to the limitation of the use of 10 hazardous substances in electrical and electronic equipment (Lead, Mercury, Cadmium, Hexavalent Chromium, PBB, PBDE, Bis Phthalate, BBP, DBP, DIBP).



NSF 61: NSF / ANSI-61

Fittings and tubes complying with this standard are tested and approved by NSF for contact with drinking water.



REACH regulation: no. 1907/2006

As product manufacturer, we are subject to article 33 of the regulation which defines a duty to inform when a candidate substance is present at more than 0.1% weight for weight.



NSF 42 and 58: NSF/ANSI-42/58

Tubes complying with this standard are tested and approved by NSF for drinking water treatment systems.



Pressurised equipment directive: 97/23/EC

This directive regulates the design, manufacture and assessment of pressurised equipment to ensure operating safety.



ACS: Attestation de Conformité Sanitaire (France)

Official approval issued by the Direction générale de la Santé Française (French Health Directorate), applies to constituent materials of equipment in contact with water intended for human consumption.



ATEX directive: 94/9/EC mandatory since 01/07/2003

This directive is mandatory for electrical and non-electrical equipment used in explosive gaseous or dusty atmospheres. The use of our products in these areas must be determined in accordance with the ATEX environment.



KTW: Kunststoffe und Trinkwasser (Germany)

Guidelines for the health evaluation of equipment in contact with drinking water, assessment and certification carried out by the TZW



Regulation 1935/2004

This framework regulation relates to materials and objects designed to come into contact with foodstuffs. It describes specific measures per product group (Art. 5).



W270: Food contact standard (Germany)

Standard describing a test method for determining the microbial growth on non-metal materials designed to come into contact with drinking water. Test and certification carried out by the TZW.



CFR 21: Code of Federal Regulation Title 21: Food and Drugs

This code consists of lists of prohibited substances for materials intended to come into contact with foodstuffs.



WRAS: Water Regulations Advisory Scheme

(UK) Fittings approved by this programme are declared compliant for water supply by WRc - NSF.



NSF 51: NSF / ANSI-51

Fittings and tubes complying with this standard are tested and approved by NSF for contact with drinks and foodstuffs.



DM 174: Ministerial decree (Italy)

Declaration of hygiene compliance for equipment used for drinking water, tested and certified by the TIFQ.





MEETING STRINGENT SANITARY AND ASEPTIC STANDARDS IN FOOD PROCESSING AND PACKAGING

Connecting you to reduced downtime, increased
throughput, and lower maintenance costs

Market research firm RTS Resource says natural highs, one-step convenience, foraged ingredients, flavor-full benefits, and next generation proteins are the five key food and drink trends to watch in the future.

Innova Market Insights has also highlighted the key issues of reducing waste and regaining consumer trust as top food industry trends to look out for. Plus the need for food safety will remain paramount.

FOOD PROCESSING AND PACKAGING

APPLICATIONS

Mixing | Baking | Cooling | Packaging | Filling | Washing | Labeling | Conveying

PERFORMANCE EXPECTATIONS

- FDA compliance
- Hygienic design
- Compact
- Highly reliable
- Ability to work in a vacuum
- Wide range of chemical compatibility
- Ability to withstand high temperatures
- Detectability
- Quality traceability



APPLICABLE PRODUCTS

LF3600 Electroless Nickel Plated Brass Fittings

LF3800 Stainless Steel Fittings

LIQUIfit™ Fittings and Ball Valves

TrueSeal™ Fittings and Ball Valves

Flow Controls

Stainless Steel Flow Controls



ENGINEERING DURABILITY

Withstanding harsh washdown chemicals



Situation: A food processing equipment manufacturer was receiving customer complaints about fittings that degraded when exposed to harsh washdown chemicals in food processing plants.

Solution: Parker's Prestolok® Composite fittings. Manufactured from an engineered grade of glass-filled nylon, the fittings withstood exposure to the aggressive washdown chemicals. Additionally, the compact fittings, available in a wide variety of configurations, maintained full airflow throughout the system, which allowed the equipment designers to optimize the routings.

Benefits:

- Reduced warranty service
- Reduced component quantity
- Reduced energy consumption due to full-flow design





COLLABORATING FOR LEAK-FREE INNOVATION IN LIFE SCIENCE

Connecting you to higher productivity,
increased efficiency, and faster assembly



According to Deloitte, a changing health care landscape, expiring patents, generic competition, pricing pressures, heightened regulatory scrutiny, expansion into emerging markets, increasing alliances and acquisitions, and a persistent economic slowdown are prompting global life sciences companies to adopt new business models designed to counter slowing sales growth and declining profitability, deliver better patient outcomes at lower cost, and position them for success.

APPLICATIONS

Oxygen Transfer | Fluid Transfer | Dispensing | Cleaning and Sterilization | Pneumatic Circuits



PERFORMANCE EXPECTATIONS

- Quality traceability
- Cleanliness
- Compact design
- Suitable for use with O₂
- High reliability
- Installation flexibility

APPLICABLE PRODUCTS

LF3600 Electroless Nickel Plated Brass Fittings

LF3800 Stainless Steel Fittings

LIQUIfit™ Fittings and Ball Valves

TrueSeal™ Fittings and Ball Valves

Stainless Steel Flow Controls



ENGINEERING INTEGRATED ASSEMBLIES

Single-piece solution simplifies, speeds, and economizes



Situation: A major medical OEM was using a very labor-intensive, six-step assembly process for an oxygen service connection.

Solution: Working with a distributor, Parker developed a customized, single-piece filtering cartridge, cleaned for oxygen use. The OEM was able to eliminate five components and five assembly steps, saving \$19.88 per unit. With 3,000 units annually, the OEM was able to reduce total costs by \$59,640.

Benefits:

- Reduced assembly time and installation labor costs
- Reduced type and quantity of components
- Reduced potential leak points
- Reduced total product costs





IN WATER AND BEVERAGE: KEEPING IT CLEAN, KEEPING IT SAFE

Connecting you to leak-free innovation,
smaller footprints, and faster assembly

According to Innova Market Insights, now is the time for the small innovator who develops a distinct product. These products' small-scale appeal will be accompanied by big trend potential accelerated by social media platforms. A more holistic approach to nutritious beverage solutions is another trend. These "well drink" trends will include more function in functional beverages, better sweetened drinks, and healthy alcohol-based beverages.

WATER AND BEVERAGE

APPLICATIONS

Filtration | Purification | Processing | Dispensing | Bottling | Treatment | Aeroionics

PERFORMANCE EXPECTATIONS

- Manufactured from FDA-compliant materials
- Meet NSF-61 requirements for potable water contact
- Excellent chemical resistance
- Wide range of fluid compatibility
- Mechanical resistance
- Installation flexibility
- Quality traceability



DID YOU KNOW?

Parker's entire LIQUIfit™ line is now available in Kynar. A fluoropolymer with excellent chemical and abrasion resistance, mechanical strength, and dielectric properties, Kynar is an excellent choice for high purity water.

APPLICABLE PRODUCTS

- Check Valves
- LIQUIfit™ Fittings
- Thermoplastic Ball Valves
- TrueSeal™ Fittings
- Fast & Tite® Fittings
- Par-Barb® Fittings



NEW LOW LEAD AMENDMENT

What it means for you



Effective January 4, 2014, all products in contact with drinking water were limited to a maximum lead content of 0.25% for all wetted components. The new rule, which mostly replicated California's regulation governing lead in drinking water, impacts virtually every component of a water treatment and distribution system, as well as services and applications that provide water suitable for human ingestion (think food preparation, beverage manufacturing, and dishwashing, for example).

Products excluded from the lead rule include those used exclusively for nonpotable services such as manufacturing, industrial processing, and irrigation.

Leaded components already in use by the January 4, 2014 deadline are grandfathered in. Repairs can be made in place, but once a leaded component is removed for any reason, it must be replaced with a lead-free component.

Parker Fluid System Connectors is committed to growing its "lead free" product offerings in both brass and nylon product ranges. Our existing low lead products – LIQUIfit™, TrueSeal™, and Green Brass – are available in a range of styles and are:

- Suitable for high-pressure brewing and dispensing at temperatures up to 400° F
- Flavor-neutral
- Designed for harsh commercial environments
- More cost effective than other metals, including stainless steel



IMPROVING DURABILITY, LESSENING RISK IN PETROCHEMICAL MANUFACTURING

Connecting you to higher productivity,
faster assembly, and leak-free innovation

The Institute for Trend Research predicted 2014 would be a growth year for North American petrochemical manufacturers. Abundant gas, tight oil, and potential energy self-sufficiency would spur investments in the U.S. and Canada. Overseas opportunities from emerging countries would also increase. This very strong growth is predicted to continue the following year. As a result, companies should focus now on cutting costs, right-sizing, creating new products, and hiring good people to take advantage of the upswing.

PETROCHEMICAL MANUFACTURING

APPLICATIONS

Processing | Transferring | Pneumatic Circuits | Cooling | Measuring



PERFORMANCE EXPECTATIONS

- High chemical resistance
- Robust design
- Excellent chemical compatibility
- Wide temperature range
- Quality traceability

APPLICABLE PRODUCTS

- LF3600 Electroless Nickel Plated Brass Fittings
- LF3800 Stainless Steel Fittings
- Stainless Steel Flow Controls
- TrueSeal Kynar®



CASE STUDY:

TrueSeal™ Kynar® Thermoplastic Fittings



Polyvinylidene fluoride, or PVDF – also known as Kynar – is a fluoropolymer that has excellent abrasion resistance, dielectric properties, and mechanical strength. In the area of chemical compatibility, Kynar is highly resistant to wet or dry chlorine, bromine, and other halogens, alcohols, strong acids, aliphatics, aromatics, and chlorinated solvents.

That makes our TrueSeal Kynar fittings an excellent choice for chemical processing, as well as manufacturing involving exposure to chlorine, solvents, and UV-sensitive chemicals.



Kynar® is a registered trademark of Arkema Group.





INCREASING PERFORMANCE, STANDARDIZING INVENTORY IN FACTORY / PROCESS AUTOMATION

Connecting you to increased efficiency, improved
throughput, and bottom line benefits



According to IMS research, the global industrial automation market will profit from improved economies worldwide. Frost and Sullivan predicts factories will utilize cloud computing, cyber security and mobile communication technologies to evolve into information and data hubs providing interaction between the factory floor and the enterprise across all end users. Asset management and flexible manufacturing will also play a role in driving factory enterprise integration.

FACTORY / PROCESS AUTOMATION

APPLICATIONS

Processing | Transferring | Pneumatic Circuits | Cooling | Measuring

ENGINEERING PRODUCTION THROUGHPUT

Higher flow and more accurate speed control enhance process automation for a faster production rate



Situation: A food packaging integrator built a custom piece of equipment to transfer uncooked product in and out of curing ovens. The rodless cylinder used to shuttle racks from the conveyor into the ovens was not moving fast enough to keep up with the anticipated production rate.

Solution: Parker replaced the rodless cylinder with a smaller Parker Legris flow control, creating faster rack movement and finer speed adjustment. The advanced flow control is now standard for the company's pneumatic cylinders.

Benefits: Optimal flow • Finer speed adjustment • Enhanced production rate



PERFORMANCE EXPECTATIONS

- Compact design
- Weld spatter resistance
- Robustness
- Vacuum performance
- High reliability
- Mechanical resistance
- Installation flexibility

APPLICABLE PRODUCTS

Prestolok® PLP Metal Fittings

LF3000 Composite Fittings

LF3600 Metal Fittings

Flow Controls



Fitting Threads

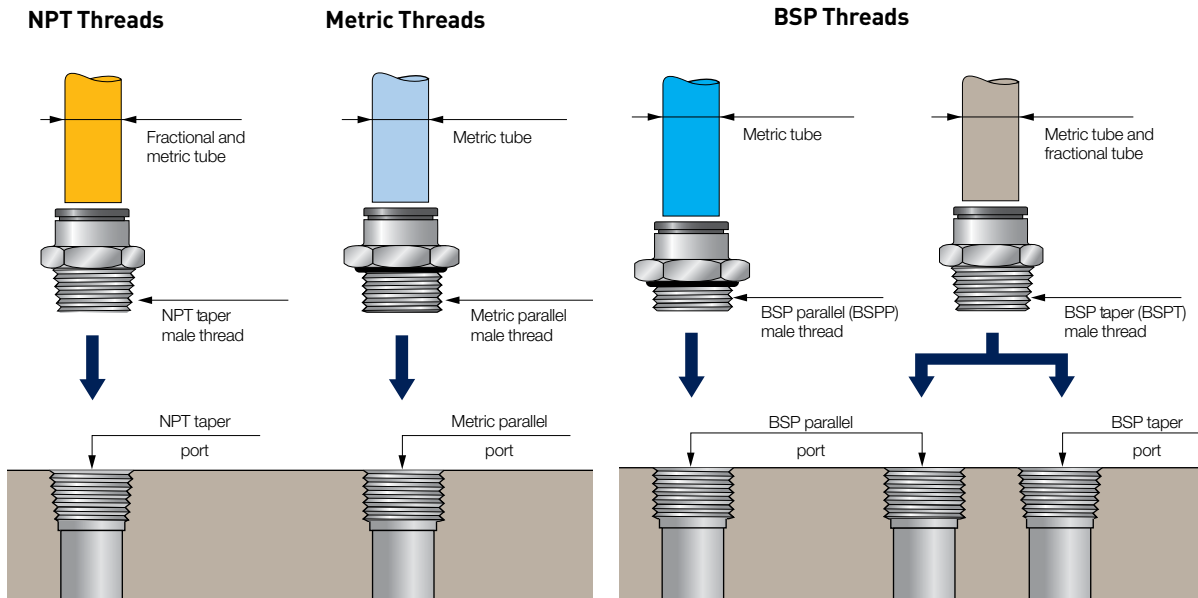

NPT Threads (National Pipe Thread)

This is an American standard taper thread which fits into the matching taper port. Sealing is provided by a pre-applied thread sealant on the thread. Example: 1/8 NPT thread = 1/8 NPT

Metric Threads

These ISO-profile threads are parallel and are fit into the matching parallel port. Sealing is provided by an O-ring or a sealing washer.

Thread designation

- M depending on the diameter and pitch in millimetres, separated by a multiplication sign, in accordance with standards ISO 68-1 and ISO 965-1.

Example: metric thread diameter 7 with a pitch of 1 mm = M7x1

BSP Threads (British Standard Pipe)

There are two types of "Pipe" profile threads:

- **Parallel (BSPP):** these threads fit in matching parallel ports. Sealing is provided by an O-ring gasket or a sealing washer.
- **Taper (NPT & BSPT):** these threads fit in matching parallel or taper ports. Sealing is provided by a pre-applied thread sealant on the thread.

Thread designation

- **BSP Parallel (BSPP):**

G followed by the denomination, according to standard ISO 228-1.
Example: 1/8 BSP parallel thread = G1/8

- **BSP Taper (BSPT):**

R followed by the denomination, according to standard ISO 7-1.
Example: 1/8 BSP taper (BSPT) thread = R1/8

- **Female threads:**

BSP parallel: G followed by the designation
BSP taper: R followed by the designation

Thread Identification

NPT Thread	Code	BSP/BSP Thread	Code
1/16	08	1/8	10
1/8	11	1/4	13
1/4	14	3/8	17
3/8	18	1/2	21
1/2	22	3/4	27
3/4	28	1"	34
1"	35	1 1/4"	42
1 1/4"	43	1 1/2"	49
1 1/2"	50	2"	48
2"	44		

Metric Thread	Code	Metric Thread	Code	Metric Thread	Code
M3x0.5	09	M12x1.25	66	M22x1.5	82
M5x0.8	19	M12x1.5	67	M24x1.5	83
M6x1	52	M13x1.25	68	M27x1.5	85
M7x1	55	M14x1.25	70	M30x2	88
M8x1	56	M14x1.5	71	M33x1.5	90
M8x1.25	57	M16x1.25	74	M39x1.5	36
M10x1	60	M16x1.5	75	M42x1.5	37
M10x1.5	62	M18x1.5	78	M42x2	96
M12x1	65	M20x1.5	80	M48x2	98

Practical Information

Threaded Connections

NATIONAL PIPE THREAD

Nominal Thread Size	Threads Per Inch	Max. Torque (inch pounds)	Handtight Engagement	Thread O.D. at Small End
10-32UNF	32	13	Seals Flush	0.187" (4.75mm)
1/16	27	—	0.28" (7.1mm)	0.271" (6.8mm)
1/8	27	70	0.37" (9.4mm)	0.363" (9.2mm)
1/4	18	100	0.49" (12.4mm)	0.477" (12.1mm)
3/8	18	250	0.627" (15.9mm)	0.612" (15.5mm)
1/2	14	308	0.778" (19.7mm)	0.758" (19.2mm)

BRITISH STANDARD PIPE

Nominal Thread Size	Threads per inch	Male Parallel Thread O.D.	Female Parallel Thread I.D.
1/8	28	0.375" (9.5mm)	0.344" (8.7mm)
1/4	19	0.531" (13.5mm)	0.438" (11.1mm)
3/8	19	0.656" (16.7mm)	0.534" (13.6mm)
1/2	14	0.813" (20.6mm)	0.719" (18.3mm)

METRIC THREAD

Metric Thread Size	Male Thread O.D. (mm)	Metric Thread Size	Male Thread O.D. (mm)	Metric Thread Size	Male Thread O.D. (mm)
M3 x 0.5	3	M13 x 1.25	13	M26 x 1.50	26
M5 x 0.75	5	M14 x 1	14	M27 x 1.50	27
M6 x 0.75	6	M14 x 1.25	14	M27 x 2	27
M6 x 1	6	M14 x 1.50	14	M30 x 1.50	30
M7 x 0.75	7	M15 x 1.25	15	M30 x 2	30
M7 x 1	7	M15 x 1.50	15	M33 x 1.50	33
M8 x 1	8	M16 x 1.25	16	M33 x 2	33
M8 x 1.50	8	M16 x 1.50	16	M24 x 2	24
M9 x 0.75	9	M17 x 1.25	17	M36 x 2	36
M9 x 1	9	M18 x 1.25	18	M39 x 2	39
M10 x 1	10	M18 x 1.50	18	M52 x 2	52
M10 x 1.25	10	M20 x 1.50	20	M42 x 2	42
M10 x 1.50	10	M21 x 1.50	21	M45 x 2	45
M11 x 1	11	M22 x 1.50	22	M48 x 2	48
M12 x 1	12	M23 x 1.50	23	M52 x 2.50	52
M12 x 1.25	12	M24 x 1.50	24		
M12 x 1.50	12	M25 x 1.50	25		



When looking at a Parker Legris fitting or adapter, an NPT fitting will have machined notches on the hex. BSPT fittings will not have machined notches.

This applies to all threaded fittings, adapters, and right angle flow control valves.

Threaded Profiles (Actual Size)

NPT

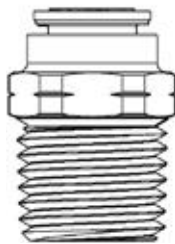

1/2"

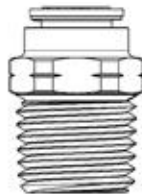

3/8"



1/4"



1/8"

BSPT

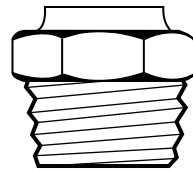

R1/2"

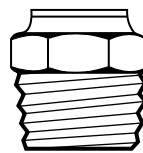

R3/8"

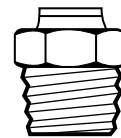

R1/4"



R1/8"

BSPP

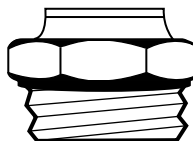

G1/2"

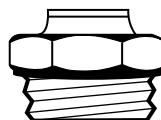

G3/8"



G1/4"



G1/8"

Metric/UNF



M7



M5



M3



10-32 UNF

Product Selector

Product	Body Material	Fluids	Temperature		Maximum Pressure		Tubing Size	
			MIN.	MAX.	PSI	BAR	IN.	MM

Pneumatic Fittings

PLP Metal	Nickel-plated brass		0° F (-18° C)	+200° F (+93° C)	300	21	1/8 - 1/2	-
LF3000®	Glass-reinforced nylon 6.6/brass/NBR	Compressed air	-4° F (-20° C)	+175°F (+79° C)	290	20	1/8 - 1/2	3 - 14
LF3600	Chemical nickel-plated brass FDA/FKM	All liquids and gases	-13° F (-25° C)	+302° F (+150° C)	435	30	1/8 - 1/2	4 - 14
LF3800	316L stainless steel/FKM	All fluids	-13° F (-25° C)	+302° F (+150° C)	435	30	1/8 - 1/2	4 - 14

Integrated Fittings

Nylon Flow Control	Glass-reinforced nylon 6.6/ nickel-plated brass	Compressed air	32° F (0° C)	158° F (70° C)	145	10	1/8 - 3/8	4 - 14
Metal Flow Control	Treated brass/nickel-plated brass	Compressed air	32° F (0° C)	158° F (70° C)	145	10	5/32 - 3/8	4 - 14
Stainless Steel Flow Control	316L stainless steel	Compressed air	32° F (0° C)	158° F (70° C)	145	10	-	-
Blocking Valve	Nickel-plated brass	Compressed air	-4° F (-20° C)	158° F (70° C)	145	10	1/4 - 1/2	6 - 12
Piloted Non-Return Valve	Glass-reinforced nylon 6.6	Compressed air	23° F (-5° C)	140° F (60° C)	145	10	-	6 - 12
Check Valve	Glass-reinforced nylon 6.6/ nickel-plated brass	Compressed air	32° F (0° C)	158° F (70° C)	145	10	5/32 - 3/8	4 - 12
Stainless Steel Check Valve	316L stainless steel	Compressed air	-4° F (-20° C)	356° F (180° C)	580	40	1/8 - 1/2	-
Threshold Sensor	Glass-reinforced nylon 6.6	Compressed air	5° F (-15° C)	140° F (60° C)	116	8	1/8 - 1/2	-
Quick Exhaust	Nickel-plated brass	Compressed air	0° F (-18° C)	160° F (60° C)	150	10	1/8 - 1/2	-
Pressure Regulator	Glass-reinforced nylon 6.6/ nickel-plated brass	Compressed air	14° F (-10° C)	158° F (70° C)	116	8	5/32 - 3/8	4 - 10
Manually Operated Valve	Glass-reinforced nylon 6.6/ nickel-plated brass	Compressed air	15° F (-10° C)	+175°F (+80° C)	230	16	5/32 - 3/8	4 - 10
Mini Ball Valves	Nylon		-4° F (-20° C)	+175°F (+80° C)	145	10	5/32 - 3/8	4 - 12

Water & Beverage Fittings and Valves

LIQUIfit	Bio-based nylon 11/EPDM	Drinking water, treated water, beverages	+35° F (1° C)	+200° F (+93° C)	230	16	1/4 - 1/2	4 - 12
TrueSeal Acetal	Acetal	All liquids and gases	-20° F (-29° C)	+180° F (+85° C)	300	21	1/4 - 1/2	-
TrueSeal Polypropylene	Polypropylene	All liquids and gases	0° F (-18° C)	+225° F (+110° C)	150	10	1/4 - 1/2	-
TrueSeal Kynar	Kynar	All liquids and gases	0° F (-18° C)	+275° F (+135° C)	300	21	1/4 - 1/2	-
Fast & Tite Polypropylene	Polypropylene	All liquids and gases	0° F (-18° C)	+212° F (+100° C)	300	21	1/4 - 5/8	-
Fast & Tite Nylon	Nylon	All liquids and gases	-40° F (-40° C)	+200° F (+93° C)	300	21	1/4 - 5/8	-
Par-Barb Polypropylene	Polypropylene	All liquids and gases	+10° F (-12° C)	+220° F (+104° C)	125	9	1/8 - 3/4	-
Par-Barb Nylon	Nylon	All liquids and gases	-40° F (-40° C)	+200° F (+93° C)	125	9	1/8 - 1 1/2	-
LIQUIfit Ball Valves	Polypropylene	All liquids and gases	35° F (1° C)	+200° F (+93° C)	150	10	1/4 - 1/2	4 - 12
TrueSeal Ball Valves	Polypropylene	All liquids and gases	0° F (-18° C)	+225° F (+107° C)	150	10	1/4 - 3/8	-
Par-Barb Ball Valves	Polypropylene	All liquids and gases	+35° F (1° C)	+200° F (+93° C)	150	10	1/4 - 3/8	-
Check Valves	Acetal	All liquids and gases	+34° F (+1° C)	+150° F (+65° C)	150	10	1/4 - 3/8	-

Cartridges

LF3000®	Glass-reinforced nylon 6.6/brass	Compressed air	-4° F (-20° C)	+176°F (+80° C)	290	20	1/8 - 1/2	3 - 14
LIQUIfit	Bio-based nylon 11/EPDM	Drinking water, treated water, beverages	+ 34°F (+1° C)	+200°F (+93° C)	230	16	1/4 - 1/2	4 - 12
LF3600	Chemical nickel-plated brass FDA/FKM	All liquids and gases	-13° F (-25° C)	+302°F (+150° C)	435	30	1/8 - 1/2	4 - 14
LF3800	316L stainless steel/FKM	All fluids	-13° F (-25° C)	+245°F (+118° C)	290	20	1/8 - 1/2	4 - 14

Product	Body Material	Fluids	Temperature		Maximum Pressure		Tubing Size	
			MIN.	MAX.	PSI	BAR	IN.	MM

Industrial Compression Style Fittings

Compression	Compression	Brass	-65° F (-54° C)	+250° F (+121° C)	2800	193	1/8 - 7/8	
Compress-Align	Compression	Brass	-65° F (-54° C)	+250° F (+121° C)	2800	193	1/8 - 1	
Metric Compression	Compression	Brass	-40° F (-40° C)	+482° F (+250° C)	3335	230		4 - 22
Poly-Tite	Compression	Brass	0° F (-18° C)	+150° F (+65° C)	150	10	1/4 - 1/2	
Hi-Duty	Compression	Brass	-65° F (-54° C)	+250° F (+121° C)	4300	296	1/8 - 5/8	

Industrial Barbed Fittings

Dubl-Barb	Barbed	Brass	-65° F (-54° C)	(1/4-3/8) - +90° F (+32° C) (1/2) - +75° F (+24° C)	(1/4 - 3/8) 150 (1/2) 100	(1/4 - 3/8) 10 (1/2) 7		
Hose Barbs	Barbed	Brass	-40° F (-40° C)	+160° F (+71° C)	150	10	1/4 - 1	

Industrial Adapters

Pipe	Threaded	Brass	-65° F (-54° C)	+250° F (+121° C)	1,000	69	1/8 - 1	
ISO Port Adapters		Brass	Dependent on Tubing or Hose End Connection					
Garden Hose		Brass	+35° F (+2° C)	+100° F (+38° C)	75	5		

Quick Acting Couplers

C9000 Safety Couplers	Glass-reinforced nylon 6.6	Compressed air	-4° F (-20° C)	+140° F (+60° C)	230	16	-	-
Metal Quick-Acting Couplers	Zinc-plated steel	Compressed air, compatible fluids	-40° F (-40° C)	+250° F (+121° C)	250	17	-	-

Industrial Valves

Universal Ball Valves	Nickel-plated brass	Compressed air, industrial fluids	-40° F (-40° C)	+176°F (+80° C)	580	40	-	-
500 Series	Female/Female	Brass	0° F (-18° C)	+350° F (+176° C)	600	41		
520 Series	Female/Female	Brass	0° F (-18° C)	+350° F (+176° C)	600	41		
525 Series	Female/Female	Brass	-40° F (-40° C)	+350° F (+176° C)	600	41		
708 Series	Male/Female	Brass	-35° F (-37° C)	+300° F (+148° C)	500	34		
709 Series	Female/Female	Brass	-35° F (-37° C)	+300° F (+148° C)	500	34		
501SS	Male/ Female	Stainless Steel	0° F (-18° C)	+400° F (+204° C)	2,000	137		
502SS	Female/Female	Stainless Steel	0° F (-18° C)	+400° F (+204° C)	2,000 (1/4 - 1) 1,500 (1 1/4 - 2)	137 (1/4 - 1) 103 (1 1/4 - 2)		
Mini Series Ball Valves	Glass-reinforced nylon 6.6/ nickel-plated brass	Compressed air	-4° F (-20° C)	+176°F (+80° C)	145	10	5/32 - 3/8	4 - 12
Standard Series Ball Valves	Nickel- or chromium-plated brass	All industrial fluids	-4° F (-20° C)	+266°F (+130° C)	435	30	-	-
Stainless Steel Series Ball Valves	316L stainless steel	All fluids	-4° F (-20° C)	+302°F (+150° C)	580	40	-	-
Axial Valves	Nickel-plated brass	Compressed air	-4° F (-20° C)	+275°F (+135° C)	150	10	-	-

Tubing

Nylon	Semi-rigid nylon	Compressed air, industrial fluids	-65° F (-54° C)	+200°F (+93° C)	375	26	1/8 - 1/2	4 - 16
Nylon Coil Tubing	Nylon material	Compressed air, industrial fluids	-40° F (-40° C)	+176°F (+80° C)	250	17	1/4 - 5/16	-
Polyurethane	Polyurethane 95A durometer	Compressed air, industrial fluids	-40° F (-40° C)	+165°F (+74° C)	233	16	1/8 - 1/2	4 - 16
Polyurethane Mini Coil Tubing	Polyurethane 95A durometer	Compressed air, industrial fluids	-40° F (-40° C)	+165°F (+74° C)	233	16	1/8 - 3/8	-
Polyurethane Coil Tubing	Polyurethane 95A durometer	Compressed air	-40° F (-40° C)	+165°F (+74° C)	150	10	5/16 - 3/8	-
Polyethylene	Low density polyethylene (LLDPE)	Compressed air, industrial fluids	-80° F (-62° C)	+151°F (+66° C)	190	13	5/32 - 1/2	-

NOTE: DO NOT ALLOW MEDIA TO FREEZE OR PRODUCT DAMAGE MAY OCCUR. REFER TO USER RESPONSIBILITY ON PAGE 0.



Pneumatic: Push to Connect

Prestolok PLP
Push-to-Connect Fittings

LF3000® Push-to-Connect
Fittings

Self-Sealing and
Oscillating Fittings

LF3600 Metal
Push-to-Connect Fittings

LF3800 Stainless Steel
Push-to-Connect Fittings



For more product information visit:
www.parker.com/automation-fittings



GOODYEAR
RUBBER PRODUCTS, INC.

📞 727-342-5088

You can also email us at
GRP@goodyearrubberproducts.com

Principle and Advantages of the Push-to-Connect Fitting

The push-to-connect fitting is the simplest way of connecting tubes to a fitting in order to create a fluid distribution network. Due to its quick installation, versatility and exceptional lifespan, the push-to-connect fitting improves machine efficiency.

Connection:

- Manual connection and disconnection without the use of tools
- Release button available in 5 colors, to identify different circuits



Assembly:

All straight connectors are fitted with an internal hex for ease of assembly with the use of an Allen wrench. This enables assembly in confined spaces.

Threads



Close Porting Assembly



Internal hex allows ease of assembly in tight places.

Sealing and 100% Leak-Tested:

The quality of the sealing material, selected specifically for the application, ensures excellent longevity of the fitting.

Quality of Design

- Unique and patented sealing technology
- Rigorous selection of materials:
 - NBR:** ideally suited for compressed air
 - EPDM:** perfectly suited for food and beverage
 - FKM:** all fluids and high temperatures
- 100% leak-tested in the production process

Benefits of Use

- Perfectly suited to primary vacuum
- Full bore for optimum flow
- Optimum gripping of tube

Gripping Ring Technology



- Ideal for nylon tubing
- Excellent tube guidance
- Optimum sealing
- Compact solution

Gripping with Collet



- For nylon and grooved metal tubing (groove drawings available on request)
- Resistant to high pressure, excellent lifespan
- Robust solution for harsh environments

⚠ WARNING These products can expose you to chemicals including LEAD which is known to the state of California to cause cancer.

Prestolok PLP Push-to-Connect Fittings

p. A6



Fluids: compressed air

Materials: Nickel-plated brass, NBR

Pressure: vacuum to 300 PSI (20.6 bar)

Temperature: 0° to 200° F (-17.7° to 93.3° C)

Fractional Inch Tube: 1/8 to 1/2

Metric Tube: NA

LF3000® Push-to-Connect Fittings

p. A12



Fluids: compressed air

Materials: glass-reinforced nylon 6.6 body, nickel plated brass, NBR

Pressure: Gripping ring technology: vacuum to 290 psi maximum (20 bar)
(3/16): vacuum to 260 psi (18 bar) maximum
*depending on tubing used

Temperature: -4° to 175° F (-20° to 80° C),
3/16" 5° to 155° F (-15° to 68° C), collet technology

Fractional Inch Tube: 1/8 to 1/2

Metric Tube: 4mm to 16mm

LF3600 Push-to-Connect Fittings

p. A53



Fluids: compressed air, all liquid and gaseous fluids

Materials: high phosphorus nickel-plated brass, FKM

Pressure: Collet technology: vacuum to 435 psi (30 bar) maximum
*depending on tubing used

Temperature: -13° to 250° F (-25° to 121° C)
*depending on tubing used

Fractional Inch Tube: 5/32 to 1/2

Metric Tube: 4mm to 14mm

LF3800 Push-to-Connect Fittings

p. A64



Fluids: industrial fluids, chemicals and medical fluids

Materials: stainless steel, FKM

Pressure: Collet technology: vacuum to 290 psi (20 bar) maximum
*depending on tubing used

Temperature : -4° to 245° F (-20° to 118° C)
*depending on tubing used

Fractional Inch Tube: 5/32 to 1/2

Metric Tube: 4mm to 12mm

WARNING These products can expose you to chemicals including LEAD which is known to the state of California to cause cancer.



Prestolok PLP Push-to-Connect Fittings

Prestolok PLP push-to-connect metal fittings with its wide variety configurations allows you to find the perfect product to meet your needs, optimizing the use of your equipment.

Product Features:

- Stainless steel grab ring
- Nickel-plated brass body
- Nitrile seal
- Polyacetal release button
- Corrosion resistance
- NPT threads

Markets:

- Industrial
- Automotive
- Climate Control
- Welding
- Packaging

Applications:

- Air
- Oil
- Inert Gases
- Vacuum

Specifications:

Pressure Range Up to 300 PSI (20.6 bar)
depending on tubing

Temperature Range 0° to +200° F (-17.7° to 93.3° C)

Note: Vacuum applications are dependent upon temperature and type of tubing used

Compatible Tubing:

- Polyethylene
- Polypropylene
- Semi Rigid Nylon
- Rigid Nylon
- Polyurethane 95 Durometer Shore A

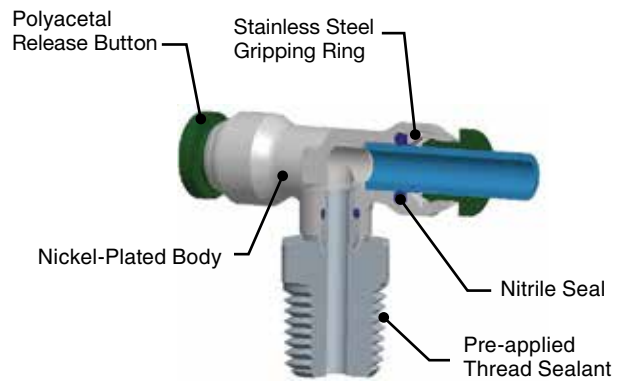

Assembly Instructions

1. Cut tubing squarely – maximum of 15° angle allowable.
2. Check that port or mating part is clean and free of debris.
3. Mark tubing to appropriate tube insertion length. (see Tube Insertion Chart on page N22)
4. Insert tubing until it bottoms
5. Pull on tubing to verify it is fully inserted
6. To disassemble, simply press release button, hold against body and pull tubing out of fitting.

■ Threaded Fittings

68PLPR

Male Connector
Round Body
UNF/NTP
p. A9



W169PLP

Male Elbow Swivel
NPT
p. A10



W169PLPNS

Male Elbow – NPT
p. A10



W171PLP

Male Run Tee
Swivel – NPT
p. A10



W172PLP

Male Branch Tee
Swivel – NPT
p. A11



W68PLP

Male Connector
NPT
p. A8



68PLP-X-0

Male Connector
NPT
p. A9



66PLP

Female Connector
NPT
p. A8



68PLP

Male Connector
BSPP
p. A9



■ Tube to Tube Fittings

164PLP

Union Tee
p. A9



165PLP

Union Elbow
p. A10



62PLP

Union
p. A8



62PLP

Unequal Union
p. A8



■ Bulkhead Unions

62PLPBH

Bulkhead Union
p. A8



66PLPBH

Female Bulkhead
Union – NPT
p. A8



Click here for CADs, Product Specifications or to Configure Parts Online

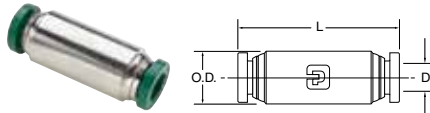

62PLP Union

PART NO.	TUBE SIZE IN	O.D.	L	FLOW DIA. D
62PLP-2	1/8	.375	1.40	.094
62PLP-3	3/16	.437	1.41	.156
62PLP-5/32	5/32	.375	1.41	.125
62PLP-4	1/4	.500	1.43	.188
62PLP-5	5/16	.562	1.65	.250
62PLP-6	3/8	.625	1.66	.312
62PLP-8	1/2	.750	1.82	.375

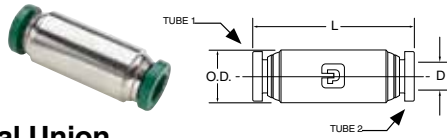

62PLP Unequal Union

PART NO.	TUBE 1 SIZE IN	TUBE 2 SIZE IN	O.D.	L	FLOW DIA. D
62PLP-5/32-2	5/32	1/8	.375	1.41	.094
62PLP-4-2	1/4	1/8	.500	1.43	.094
62PLP-4-5/32	1/4	5/32	.500	1.43	.125
62PLP-4-6	1/4	3/8	.625	1.66	.188
62PLP-6-8	3/8	1/2	.750	1.82	.312

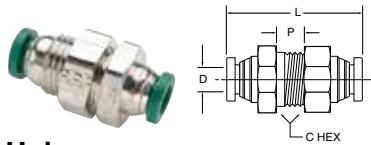

62PLPBH Bulkhead Union

PART NO.	TUBE SIZE IN	BULKHEAD HOLE DIA. B	C HEX	P MAX.	L	D
62PLPBH-2	1/8	7/16	9/16	.39	1.40	.094
62PLPBH-5/32	5/32	7/16	9/16	.39	1.41	.125
62PLPBH-4	1/4	9/16	11/16	.29	1.43	.188
62PLPBH-5	5/16	5/8	3/4	.60	1.65	.250
62PLPBH-6	3/8	3/4	7/8	.54	1.66	.312
62PLPBH-8	1/2	7/8	1	.66	2.04	.375

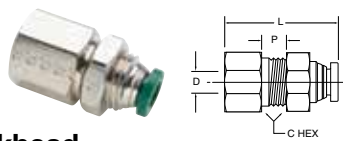

66PLPBH Female Bulkhead

PART NO.	TUBE SIZE IN	PIPE THD NPTF	C HEX	P MAX.	L	FLOW DIA. D	BKHD HOLE DIA.
66PLPBH-5/32-4	5/32	1/4	11/16	.19	1.39	.125	1/2
66PLPBH-4-4	1/4	1/4	11/16	.24	1.35	.188	9/16
66PLPBH-6-6	3/8	3/8	1	.22	1.47	.312	7/8
66PLPBH-8-6	1/2	3/8	1	.35	1.56	.344	7/8

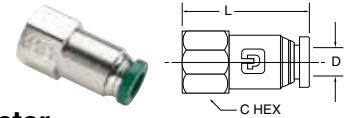

66PLP Female Connector

PART NO.	TUBE SIZE IN	PIPE THREAD NPTF	C HEX	L	FLOW DIA. D
66PLP-2-2	1/8	1/8	9/16	1.17	.094
66PLP-2-4	1/8	1/4	11/16	1.34	.094
66PLP-3-2	3/16	1/8	9/16	1.13	.156
66PLP-5/32-2	5/32	1/8	9/16	1.17	.125
66PLP-5/32-4	5/32	1/4	11/16	1.38	.125
66PLP-4-2	1/4	1/8	9/16	1.17	.188
66PLP-4-4	1/4	1/4	11/16	1.38	.188
66PLP-5-2	5/16	1/8	9/16	1.25	.250
66PLP-5-4	5/16	1/4	11/16	1.45	.250
66PLP-6-4	3/8	1/4	11/16	1.46	.312
66PLP-6-6	3/8	3/8	13/16	1.51	.312

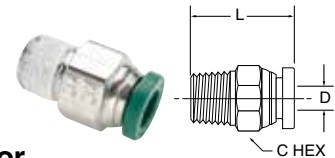

W68PLP Male Connector

PART NO.	TUBE SIZE IN	PIPE THD NPTF	C HEX	L	FLOW DIA. D
W68PLP-2-1	1/8	1/16	3/8	.79	.094
W68PLP-2-2	1/8	1/8	7/16	.79	.094
W68PLP-2-4	1/8	1/4	9/16	1.02	.094
W68PLP-3-2	3/16	1/8	7/16	.85	.156
W68PLP-3-4	3/16	1/4	9/16	1.01	.156
W68PLP-5/32-1	5/32	1/16		.88	.940
W68PLP-5/32-2	5/32	1/8	7/16	.80	.125
W68PLP-5/32-4	5/32	1/4	9/16	1.03	.125
W68PLP-4-1	1/4	1/16	1/2	1.07	.141
W68PLP-4-2	1/4	1/8	1/2	.89	.188
W68PLP-4-4	1/4	1/4	9/16	1.00	.188
W68PLP-4-6	1/4	3/8	3/4	1.04	.188
W68PLP-5-2	5/16	1/8	9/16	1.18	.250
W68PLP-5-4	5/16	1/4	9/16	1.04	.250
W68PLP-5-6	5/16	3/8	11/16	1.04	.250
W68PLP-6-2	3/8	1/8	5/8	1.21	.250
W68PLP-6-4	3/8	1/4	5/8	1.08	.312
W68PLP-6-6	3/8	3/8	11/16	1.02	.312
W68PLP-6-8	3/8	1/2	7/8	1.28	.312
W68PLP-8-4	1/2	1/4	13/16	1.44	.344
W68PLP-8-6	1/2	3/8	13/16	1.24	.344
W68PLP-8-8	1/2	1/2	7/8	1.35	.375
68PLP-5/32-4LT*	5/32	1/4-28	7/16	.88	.093

*SAE-LT threads

WARNING These products can expose you to chemicals including LEAD which is known to the state of California to cause cancer.

[Click here for CADs, Product Specifications or to Configure Parts Online](#)

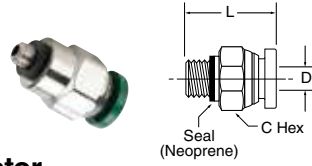

68PLP-X-0 Male Connector

PART NO.	TUBE SIZE IN	PIPE THREAD NPTF	C HEX	L	FLOW DIA. D
68PLP-2-0	1/8	10X32	3/8	.92	.094
68PLP-5/32-0	5/32	10X32	3/8	.90	.090
68PLP-4-0	1/4	10X32	1/2	.96	.094

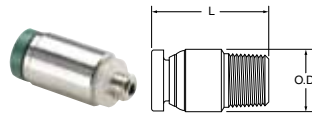

68PLPR Round Body Male Connector

PART NO.	TUBE SIZE IN	THREAD SIZE NPTF	INTERNAL HEX BROACH	BODY DIA. O.D.	L	FLOW DIA.
68PLPR-2-0*	1/8	10-32	3/32	3/8"	.89	.094
68PLPR-5/32-0*	5/32	10-32	3/32	3/8"	.91	.094
68PLPR-4-0*	1/4	10-32	3/32	1/2"	.95	.094
W68PLPR-5/32-1	5/32	1/16	1/8	7/16"	.87	.125
W68PLPR-5/32-2	5/32	1/8	1/8	7/16"	.79	.125
W68PLPR-4-1	1/4	1/16	5/32	1/2"	1.06	.156
W68PLPR-4-2	1/4	1/8	3/16	1/2"	.88	.188
W68PLPR-4-4	1/4	1/4	3/16	5/8"	.99	.188

*10-32 seal is neoprene

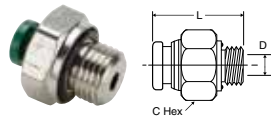

68PLP Male Connector BSPP

PART NO.	TUBE SIZE IN	PIPE THD BSPP	C HEX	L	FLOW DIA. D
68PLP-4-2G	1/4	1/8-28	11/16	1.13	.188
68PLP-4-4G	1/4	1/4-19	3/4	1.13	.188
68PLP-4-6G	1/4	3/8-19	7/8	1.09	.19
68PLP-6-4G	3/8	1/4-19	3/4	1.26	.26
68PLP-6-6G	3/8	3/8-19	7/8	1.25	.31
68PLP-6-8G	3/8	1/2-14	1-1/16	1.25	.31
68PLP-8-6G	1/2	3/8-19	7/8	1.32	.45
68PLP-8-8G	1/2	1/2-14	1-1/16	1.36	.45

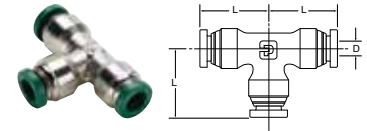

164PLP Union Tee

PART NO.	TUBE SIZE IN	L	FLOW DIA. D
164PLP-2	1/8	.74	.094
164PLP-3	3/16	.82	.156
164PLP-5/32	5/32	.77	.125
164PLP-4	1/4	.85	.188
164PLP-5	5/16	.97	.250
164PLP-6	3/8	1.01	.250
164PLP-8	1/2	1.15	.375

WARNING These products can expose you to chemicals including LEAD which is known to the state of California to cause cancer.

[Click here for CADs, Product Specifications or to Configure Parts Online](#)

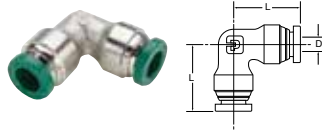

165PLP Union Elbow

PART NO.	TUBE SIZE IN	L	FLOW DIA. D
165PLP-2	1/8	.74	.094
165PLP-5/32	5/32	.77	.125
165PLP-4	1/4	.85	.188
165PLP-5	5/16	.97	.250
165PLP-6	3/8	1.01	.312
165PLP-8	1/2	1.15	.375

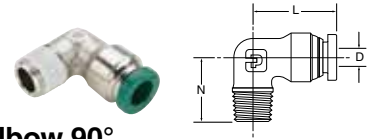

W169PLPNS Male Elbow 90°

PART NO.	TUBE IN	PIPE THD NPTF	L	N	FLOW DIA. D
W169PLPNS-2-2	1/8	1/8	.74	.67	.094
W169PLPNS5/32-2	5/32	1/8	.77	.67	.125
W169PLPNS5/32-4	5/32	1/4	.77	.87	.125
W169PLPNS-4-2	1/4	1/8	.85	.67	.188
W169PLPNS-4-4	1/4	1/4	.85	.87	.188
W169PLPNS-5-2	5/16	1/8	.97	.75	.234
W169PLPNS-5-4	5/16	1/4	.97	.94	.250
W169PLPNS-6-4	3/8	1/4	1.01	.94	.312
W169PLPNS-6-6	3/8	3/8	1.01	1.01	.312
W169PLPNS-6-8	3/8	1/2	1.01	1.27	.312
W169PLPNS-8-6	1/2	3/8	1.15	1.00	.375
W169PLPNS-8-8	1/2	1/2	1.15	1.27	.375
169PLPNS-5/32-4LT	5/32	1/4-28	.60	.48	.090

* SAE-LT Threads

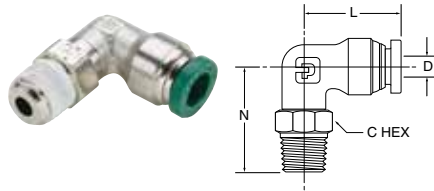

W169PLP Male Elbow Swivel 90°

PART NO.	TUBE SIZE IN	PIPE THREAD NPTF	C HEX	L	N	FLOW DIA. D
W169PLP-2-1	1/8	1/16	3/8	.74	.93	.160
W169PLP-2-2	1/8	1/8	7/16	.74	.92	.094
169PLP-2-0*	1/8	10-32	3/8	.74	.74	.080
W169PLP-2-4	1/8	1/4	9/16	.74	1.10	.094
W169PLP-3-2	3/16	1/8	7/16	.82	.92	.156
W169PLP-5/32-1	5/32	1/16	3/8	.84	.93	.160
W169PLP-5/32-2	5/32	1/8	7/16	.77	.92	.125
W169PLP-5/32-4	5/32	1/4	9/16	.77	1.10	.125
169PLP-5/32-0*	5/32	10-32	3/8	.85	.74	.080
W169PLP-4-1	1/4	1/16	3/8	.84	.93	.160
W169PLP-4-2	1/4	1/8	7/16	.85	.92	.156
W169PLP-4-4	1/4	1/4	9/16	.85	1.10	.156
W169PLP-4-6	1/4	3/8	11/16	.85	1.19	.156
169PLP-4-0*	1/4	10-32	3/8	.85	.74	.080
W169PLP-5-2	5/16	1/8	9/16	.97	1.02	.250
W169PLP-5-4	5/16	1/4	9/16	.97	1.24	.250
W169PLP-6-2	3/8	1/8	9/16	1.01	1.02	.250
W169PLP-6-4	3/8	1/4	9/16	1.01	1.24	.250
W169PLP-6-6	3/8	3/8	11/16	1.01	1.24	.250
W169PLP-6-8	3/8	1/2	7/8	1.01	1.48	.250
W169PLP-8-4	1/2	1/4	9/16	1.15	1.28	.312
W169PLP-8-6	1/2	3/8	11/16	1.15	1.31	.312
W169PLP-8-8	1/2	1/2	7/8	1.15	1.52	.312

*10-32 seal is neoprene

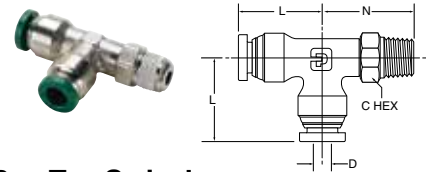

W171PLP Male Run Tee Swivel

PART NO.	TUBE SIZE IN	PIPE THREAD NPTF	C HEX	L	N	FLOW DIA. D
W171PLP-2-2	1/8	1/8	7/16	.74	.92	.094
W171PLP-5/32-2	5/32	1/8	7/16	.77	.92	.125
W171PLP-4-2	1/4	1/8	7/16	.85	.92	.156
W171PLP-4-4	1/4	1/4	9/16	.85	1.10	.156
W171PLP-4-6	1/4	3/8	11/16	.85	1.24	.156
W171PLP-5-2	5/16	1/8	9/16	.97	1.02	.250
W171PLP-5-4	5/16	1/4	9/16	.97	1.24	.250
W171PLP-6-4	3/8	1/4	9/16	1.01	1.24	.250
W171PLP-6-6	3/8	3/8	11/16	1.01	1.24	.250
W171PLP-8-6	1/2	3/8	11/16	1.15	1.31	.312
W171PLP-8-8	1/2	1/2	7/8	1.15	1.52	.312

WARNING These products can expose you to chemicals including LEAD which is known to the state of California to cause cancer.

[Click here for CADs, Product Specifications or to Configure Parts Online](#)

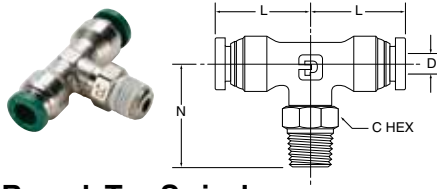

W172PLP Male Branch Tee Swivel

PART NO.	TUBE SIZE IN	PIPE THREAD NPTF	C HEX	L	N	FLOW DIA. D
W172PLP-2-2	1/8	1/8	7/16	.74	.92	.094
W172PLP-3-2	3/16	1/8	7/16	.82	.92	.156
W172PLP-5/32-2	5/32	1/8	7/16	.77	.92	.125
172PLP-4-0	1/4	10-32	3/8	.84	.80	.250
W172PLP-4-2	1/4	1/8	7/16	.85	.92	.156
W172PLP-4-4	1/4	1/4	9/16	.85	1.10	.156
W172PLP-4-6	1/4	3/8	11/16	.85	1.10	.156
W172PLP-5-2	5/16	1/8	9/16	.97	1.02	.250
W172PLP-5-4	5/16	1/4	9/16	.97	1.24	.250
W172PLP-6-4	3/8	1/4	9/16	1.01	1.24	.250
W172PLP-6-6	3/8	3/8	11/16	1.01	1.24	.250
W172PLP-6-8	3/8	1/2	7/8	1.00	1.48	.250
W172PLP-8-4	1/2	1/4	9/16	1.15	1.30	.312
W172PLP-8-6	1/2	3/8	11/16	1.15	1.31	.312
W172PLP-8-8	1/2	1/2	7/8	1.15	1.52	.312

WARNING These products can expose you to chemicals including LEAD which is known to the state of California to cause cancer.



LF3000® Push-to-Connect Fittings

LF3000 push-to-connect fittings with its wide variety configurations allows you to find the perfect product to meet your needs, optimizing the use of your equipment.

Product Features:

- Stainless steel grab ring
- Glass-reinforced nylon 6.6 body
- Nitrile D-seal
- Nylon release button
- Corrosion and chemical resistance
- NPT, BSPT, BSPP, and metric threads
- Silicone-Free

Markets:

- Pneumatic
- Industrial
- Robotic
- Automation
- Printing
- Packaging
- Textile

Applications:

- Air
- Cutting Fluids
- Inert Gases
- Vacuum

Specifications:

	Up to 290 psi (20 bar)
	3/16" diameter up to 260 psi (8 bar)
Pressure Range	Maximum working pressure and temperature range are dependent on the type of tubing used
	-4° to +175° F (-20° to +80° C)
Temperature Range	3/16" diameter 5° to +155° F (-15° to +68° C)
Vacuum Capability	28" Hg

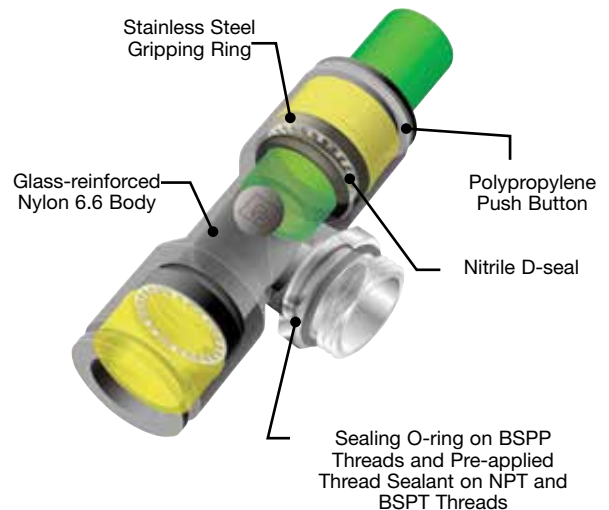

Compatible Tubing:

- Semi-Rigid Nylon
- Polyurethane 95 Durometer Shore A
- Nylon
- Fluoropolymer
- Polyethylene

■ Threaded Fittings

3175

Male Connector
NPT/BSPT
p. A16



3171

Male Connector
UNF/M5/M7
p. A17



3181

Male Connector
M5/M7
p. A17



3101

Male Connector
BSPP/Metric
p. A17



3014

Female Connector
NPT
p. A18



3114

Female Connector
BSPP
p. A18



3109

Male Elbow
NPT/UNF/BSPT
p. A19



3199

Male Elbow
BSPP/Metric
p. A20



3129

Extended Male
Elbow
NPT/BSPT
p. A20



3169

Extended Male
Elbow
UNF/BSPP/Metric
p. A21



3009

Female Elbow
NPT
p. A21



3192

Female Elbow
BSPP
p. A21



3113

45° Male Elbow
NPT/UNF/BSPT
p. A22



3133

45° Male Elbow
BSPP/M5
Metric
p. A22



3108

Male Branch Tee
NPT/UNF/BSPT
p. A23



3198

Male Branch Tee
BSPP/M5
p. A24



3008

Female Branch Tee
NPT
p. A24



3193

Male Run Tee
BSPP/M5
p. A24



3103

Male Run Tee
NPT/UNF/BSPT
p. A25



3121

Male Standpipe
NPT/BSPT
p. A26



3131

Male Standpipe
UNF/BSPP/M5
p. A26



3148

Y Male Connector
NPT/BSPT
p. A27



3158

Y Male Connector
BSPP/M5
p. A27



3112

Double Y Male
Connector
BSPT
p. A27



3132

Double Y Male
Connector
BSPP
p. A27



3018

Banjo
NPT/BSPT
p. A29



3118

Banjo
UNF/BSPP/M3/M5
p. A29



3124

Banjo W/BSPP
Bolt BSPP/M5
p. A31



3149/3049

Twin Banjo
NPT/UNF/BSPP/M5
p. A32



3119

Double Banjo
BSPP/M5
p. A32



3159

Male Elbow
NPT/BSPT
p. A50



3189

Male Elbow
BSPP/M5
p. A50



■ Tube to Tube Fittings

3106

Union
p. A32, A33



3102

Union Elbow
p. A33



3104

Union Tee
p. A34



3140

Y Union
p. A35



3144

Multiple Y Union
p. A35



3304

Multiple Tee
p. A38



3306

Double Multiple Tee
p. A38



3107

Equal Cross
p. A38



■ Bulkhead Connector Fittings

3146

Female Bulkhead
p. A36



3036/3136

Female Bulkhead
NPT/BSPP
p. A36



3139

Equal Bulkhead
p. A36



3116

Bulkhead Union
p. A37



3156

Plug-In Bulkhead
Union
p. A37



■ Plug-In Fittings

3182

Plug-In Elbow
p. A39



3184

Extended Plug-In
Elbow
p. A39



3180

45° Plug-In Elbow
p. A39



3188

Plug-In Tee
p. A40



3183

Plug-In Run Tee
p. A40



3142

Plug-In Y
p. A41



3143

Plug-In Multiple Y
p. A41



3166

Reducer
p. A42



3168

Expander
p. A42



■ Plug-In Accessories

3120

Double Male Union
p. A41



3126

Plug
p. A43



3122

Barbed
Connector
p. A43



■ Self-Sealing Fittings

3091

Self-Sealing Male
Connector
NPT/BSPT
p. A49



3391

Self-Sealing Male
Connector
BSPP
p. A49



3160

Self-Sealing Plug-In
Connector
p. A49



■ DIN Rail & Multi-Tube Connectors

3379

Connector for
2 Tubes In Line
p. A45



3381

Connector for
3 Tubes
p. A45



3300

Modular Plug-In
Connectors
p. A46



3320

Male Connector
Body
p. A47



3321

Female Connector
Body
p. A47



3329

Cap
p. A47



■ **Modular Fittings**

3538

Single Banjo Body
p. A30



3539

Double Banjo Body
p. A30



3549

Twin Banjo Body
p. A30



3527

Single Banjo Bolt
BSPP/M5
p. A31



3528

Stacking Banjo
BSPP/M5
p. A31



3529

Stacking Banjo
BSPP
p. A31



3524

Female Threaded
Banjo Bolt
BSPP/M5
p. A31



■ **Accessories**

Clip

p. A51



3151

End Cap
p. A51



3000 70

Disconnection Tool
p. A51



AQRT

Release Tool
p. A51



7000

Joining Clips
p. A51



3000 71 00

Tube Cutter
p. A51



3110/3330

Caps
p. A52



[Click here for CADs, Product Specifications or to Configure Parts Online](#)

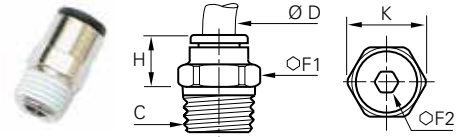
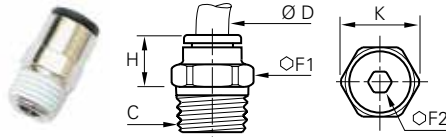

3175 Male Connector Fractional Inch Tube to Male NPT

PART NO.	ØD IN	C NPT	F1 MM	F2 IN	H IN	K IN
3175 53 08	1/8	1/16	10	.07	.413	.433
3175 53 11	1/8	1/8	11	.07	.283	.472
3175 53 14	1/8	1/4	14	.07	.315	.591
3175 04 11	5/32	1/8	11	.11	.334	.472
3175 04 14	5/32	1/4	14	.11	.275	.590
3175 55 11*	3/16	1/8	11	.12	.61	.51
3175 55 14*	3/16	1/4	14	.16	.59	.65
3175 56 11	1/4	1/8	11	.16	.472	.472
3175 56 14	1/4	1/4	14	.16	.374	.590
3175 56 18	1/4	3/8	18	.19	.295	.767
3175 08 11	5/16	1/8	13	.19	.787	.551
3175 08 14	5/16	1/4	14	.25	.661	.590
3175 08 18	5/16	3/8	18	.25	.464	.767
3175 60 11	3/8	1/8	16	.16	.894	.689
3175 60 14	3/8	1/4	16	.28	.807	.689
3175 60 18	3/8	3/8	18	.28	.689	.767
3175 60 22	3/8	1/2	22	.28	.610	.945
3175 62 14	1/2	1/4	22	.25	1.1	.945
3175 62 18	1/2	3/8	22	.28	1.1	.945
3175 62 22	1/2	1/2	22	.28	1.1	.945

3175 Male Connector Fractional Inch Tube to Male BSPT

PART NO.	ØD IN	C BSPT	F1 MM	F2 MM	H IN	K IN
3175 53 10	1/8	R1/8	10	2	.335	.433
3175 04 10	5/32	R1/8	10	3	.37	.43
3175 04 13	5/32	R1/4	14	3	.26	.59
3175 55 10*	3/16	R1/8	11	3	.61	.51
3175 55 13*	3/16	R1/4	14	3	.59	.65
3175 56 10	1/4	R1/8	11	4	.472	.472
3175 56 13	1/4	R1/4	14	4	.374	.591
3175 08 10	5/16	R1/8	13	5	.79	.55
3175 08 13	5/16	R1/4	14	6	.67	.59
3175 08 17	5/16	R3/8	17	6	.51	.73
3175 08 21	5/16	R1/2	21	6	.47	.91
3175 60 13	3/8	R1/4	16	7	.807	.689
3175 60 17	3/8	R3/8	17	7	.650	.728
3175 60 21	3/8	R1/2	21	7	.551	.906
3175 62 13	1/2	R1/4	22	6	1.06	.945
3175 62 17	1/2	R3/8	22	7	1.02	.945
3175 62 21	1/2	R1/2	24	7	.807	1.02

3175 Male Connector Metric Tube to Male NPT

PART NO.	ØD MM	C NPT	F1 MM	F2 MM	H IN	K IN
3175 04 11	4	1/8	11	3	.33	.47
3175 04 14	4	1/4	14	3	.28	.59
3175 06 11	6	1/8	11	4	.45	.47
3175 06 14	6	1/4	14	4	.33	.59
3175 08 11	8	1/8	13	5	.79	.55
3175 08 14	8	1/4	14	6	.66	.59
3175 08 18	8	3/8	18	6	.46	.77
3175 10 14	10	1/4	16	7	.79	.69
3175 10 18	10	3/8	18	8	.65	.77
3175 10 22	10	1/2	22	8	.55	.95
3175 12 14	12	1/4	19	7	.27	.21
3175 12 18	12	3/8	19	9	.95	.83
3175 12 22	12	1/2	22	10	.77	.95

3175 Male Connector Metric Tube to Male BSPT

PART NO.	ØD MM	C BSPT	F1 MM	F2 MM	H MM	K MM
3175 04 10	4	R1/8	10	3	9.5	11
3175 04 13	4	R1/4	14	3	6.5	15
3175 04 17	4	R3/8	17	3	8	18.5
3175 06 10	6	R1/8	11	4	11.5	11
3175 06 13	6	R1/4	14	4	8.5	15
3175 06 17	6	R3/8	17	4	8.5	18.5
3175 06 21	6	R1/2	21	4	9	23
3175 08 10	8	R1/8	13	5	20	14
3175 08 13	8	R1/4	14	6	17	15
3175 08 17	8	R3/8	17	6	13	18.5
3175 08 21	8	R1/2	21	6	12	23
3175 10 10	10	R1/8	16	5	22.5	17.5
3175 10 13	10	R1/4	16	7	20	17.5
3175 10 17	10	R3/8	17	8	16.5	18.5
3175 10 21	10	R1/2	21	8	14	23
3175 12 13	12	R1/4	19	7	26.5	21
3175 12 17	12	R3/8	19	9	24	21
3175 12 21	12	R1/2	21	9	19.5	23
3175 14 17	14	R3/8	22	9	28.5	24
3175 14 21	14	R1/2	24	10	23.5	26
3175 16 17	16	R3/8	27	9	32.5	29
3175 16 21	16	R1/2	27	12	32.5	29

WARNING These products can expose you to chemicals including LEAD which is known to the state of California to cause cancer.

[Click here for CADs, Product Specifications or to Configure Parts Online](#)

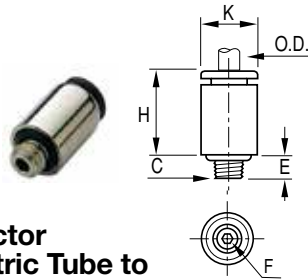

**3171/3181 Male Connector
Fractional Inch and Metric Tube to
10-32 UNF, M5 or M7**

PART NO.	ØD IN	C UNF/ METRIC	E IN	F MM	H IN	K IN
3171 53 20	1/8	10-32	.13	2	.49	.32
3171 04 20	5/32	10-32	.13	2	.54	.34
3171 56 20	1/4	10-32	.13	2	.64	.46
3181 56 19	1/4	M5	.14	2.5	.65	.41
3181 56 55	1/4	M7	.18	4	.65	.41

PART NO.	ØD MM	C UNF/ METRIC	E MM	F MM	H IN	K IN
3181 04 19	4	M5X0.8	3.5	2.5	14.5	8.5
3181 04 55	4	M7X1	5	3	14	10
3181 06 19	6	M5X0.8	3.5	2.5	16.5	11
3181 06 55	6	M7X1	5	3	10	16

Recommended for use with compact high flow valves. Because of the miniature bodies, these fittings can be placed close together. The minimum distance between centers of the fittings is 10.5mm (0.41").

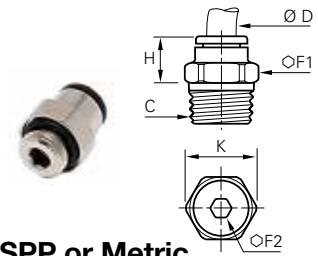
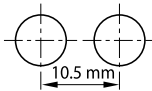

**3101 Male Connector
Metric Tube to Male BSPP or Metric**

PART NO.	ØD MM	C BSPP/ METRIC	E MM	F1 MM	F2 MM	H MM	K MM
3101 03 09	3	M3X0.5	2.5	8	-	12.5	8.5
3101 03 19	3	M5X0.8	3.5	8	2.5	12.5	8.5
3101 04 09	4	M3X0.5	2.5	8	-	14.5	8.5
3101 04 19	4	M5X0.8	3	9	2.5	14	8.5
3101 04 55	4	M7X1	5	10	2.5	14	11
3101 04 10	4	G1/8	4.5	13	3	11.5	14
3101 04 13	4	G1/4	5.5	16	3	10.5	17.5
3101 06 19	6	M5X0.8	3.5	11	2.5	16	11
3101 06 55	6	M7X1	5	10	3	16	11
3101 06 60	6	M10X1	5	13	4	13	14
3101 06 67	6	M12X1.5	5.5	15	4	13	16
3101 06 10	6	G1/8	4.5	13	4	13	14
3101 06 13	6	G1/4	5.5	16	4	12.5	17.5
3101 06 17	6	G3/8	5.5	20	4	13	22
3101 06 21	6	G1/2	7.5	24	4	20	26
3101 08 60	8	M10X1	5	13	5	21	14
3101 08 67	8	M12X1.5	5.5	15	5	21	16
3101 08 10	8	G1/8	4.5	13	5	20.5	14
3101 08 13	8	G1/4	5.5	16	6	19.5	17.5
3101 08 17	8	G3/8	5.5	20	6	18	22
3101 08 21	8	G1/2	7.5	24	6	16.5	26
3101 10 13	10	G1/4	5.5	16	7	23	17.5
3101 10 17	10	G3/8	5.5	20	8	19.5	22
3101 10 21	10	G1/2	7.5	24	8	18.5	26
3101 12 13	12	G1/4	5.5	19	7	27.5	21
3101 12 17	12	G3/8	5.5	20	9	27	22
3101 12 21	12	G1/2	7	24	10	22.5	26
3101 14 17	14	G3/8	5.5	22	9	29.5	24
3101 14 21	14	G1/2	7	24	11	28	26
3101 16 17	16	G3/8	7.5	27	9	32.5	29
3101 16 21	16	G1/2	9	27	12	32.5	29

WARNING These products can expose you to chemicals including LEAD which is known to the state of California to cause cancer.

[Click here for CADs, Product Specifications or to Configure Parts Online](#)

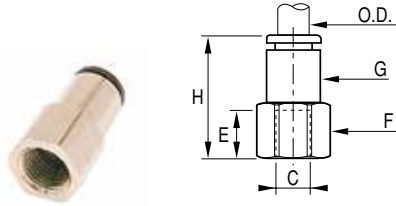

**3014 Straight Female Connector
Fractional Inch Tube to NPT**

PART NO.	ØD IN	C NPT/UNF	F MM	G IN	H IN	E IN
3014 53 11	1/8	1/8	13	.43	.87	.37
3014 53 14	1/8	1/4	16	.43	1.05	.55
3014 53 20	1/8	10-32	8	.35	.79	.22
3014 04 11	5/32	1/8	13	.33	.89	.37
3014 04 14	5/32	1/4	16	.33	1.06	.55
3014 04 20	5/32	10-32	-	-	-	-
3014 55 11*	3/16	1/8	14	-	1.06	-
3014 55 14*	3/16	1/4	17	-	1.26	-
3014 56 11	1/4	1/8	13	.42	.98	.37
3014 56 14	1/4	1/4	16	.42	1.16	.55
3014 56 20	1/4	10-32	-	-	-	-
3014 56 18	1/4	3/8	12	.42	1.81	.47
3014 08 11	5/16	1/8	13	.53	1.14	.37
3014 08 14	5/16	1/4	16	.53	1.32	.55
3014 60 11	3/8	1/8	16	.61	1.22	.37
3014 60 14	3/8	1/4	16	.61	1.40	.55
3014 60 18	3/8	3/8	24	.61	1.57	.59
3014 60 22	3/8	1/2	22	.61	1.52	.65
3014 62 14	1/2	1/4	20	.84	1.73	.47
3014 62 18	1/2	3/8	22	.85	1.81	.65
3014 62 22	1/2	1/2	24	.85	1.93	.77

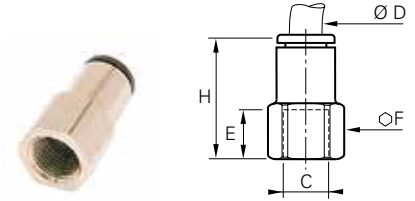

**3114 Straight Female Connector
Metric Tube to BSPP or M5**

PART NO.	ØD MM	C BSPP/M5	E MM	F MM	H MM	W KG
3114 04 19	4	M5X0.8	6.5	8	19.5	.005
3114 04 10	4	G1/8	9.5	13	22.5	.010
3114 04 13	4	G1/4	13.5	16	26.5	.016
3114 06 10	6	G1/8	9.5	13	24.5	.011
3114 06 13	6	G1/4	13.5	16	28.5	.016
3114 08 10	8	G1/8	9.5	13	29	.020
3114 08 13	8	G1/4	13.5	16	33	.027
3114 08 17	8	G3/8	14	19	34	.030
3114 10 13	10	G1/4	13.5	16	36	.037
3114 10 17	10	G3/8	14	19	36	.040
3114 10 21	10	G1/2	19.5	24	41.5	.045
3114 12 13	12	G1/4	14	19	39.5	.090
3114 12 17	12	G3/8	14	19	40	.092
3114 12 21	12	G1/2	19.5	24	45.5	.114
3114 14 17	14	G3/8	14	22	42.5	.140
3114 16 21	16	G1/2	15	27	49	.144

WARNING These products can expose you to chemicals including LEAD which is known to the state of California to cause cancer.

[Click here for CADs, Product Specifications or to Configure Parts Online](#)

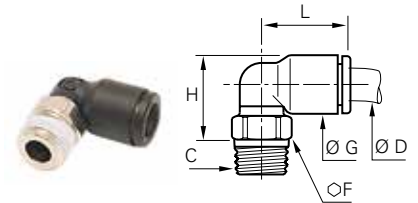
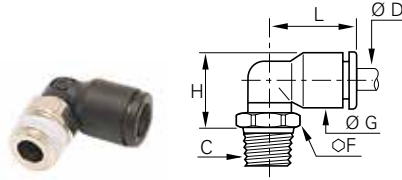

3109 Male Elbow Fractional Inch Tube to Male NPT or UNF

PART NO.	ØD IN	C NPT/UNF	F MM	G IN	H IN	L IN
3109 53 20	1/8	10-32	8	.34	.52	.57
3109 53 08	1/8	1/16	10	.34	.53	.57
3109 53 11	1/8	1/8	11	.34	.53	.57
3109 53 14	1/8	1/4	14	.34	.55	.57
3109 04 20	5/32	10-32	8	.33	.53	.55
3109 04 11	5/32	1/8	11	.33	.53	.55
3109 04 14	5/32	1/4	14	.33	.55	.55
3109 55 11*	3/16	1/8	11	.43	.67	.85
3109 56 20	1/4	10-32	11	.43	.63	.71
3109 56 11	1/4	1/8	11	.43	.67	.71
3109 56 14	1/4	1/4	14	.43	.63	.71
3109 56 18	1/4	3/8	18	.43	.65	.71
3109 08 11	5/16	1/8	11	.53	.75	.91
3109 08 14	5/16	1/4	14	.53	.71	.91
3109 08 18	5/16	3/8	18	.53	.73	.91
3109 60 11	3/8	1/8	15	.63	.91	1.08
3109 60 14	3/8	1/4	15	.63	.91	1.08
3109 60 18	3/8	3/8	18	.63	.87	1.08
3109 60 22	3/8	1/2	22	.63	.91	1.08
3109 62 14	1/2	1/4	20	.87	1.22	1.38
3109 62 18	1/2	3/8	20	.87	1.22	1.38
3109 62 22	1/2	1/2	24	.87	1.12	1.38

3109 Male Elbow Fractional Inch Tube to Male BSPT

PART NO.	ØD IN	C BSPT	F1 MM	G IN	H IN	L IN
3109 53 10	1/8	R1/8	10	.34	.53	.57
3109 04 10	5/32	R1/8	10	.34	.53	.55
3109 04 13	5/32	R1/4	14	.34	.55	.55
3109 55 10*	3/16	R1/8	11	.43	.67	.85
3109 55 13*	3/16	R1/4	14	.33	.55	.55
3109 56 10	1/4	R1/8	10	.43	.67	.71
3109 56 13	1/4	R1/4	14	.43	.63	.71
3109 08 10	5/16	R1/8	10	.53	.75	.91
3109 08 13	5/16	R1/4	14	.53	.71	.91
3109 08 17	5/16	R3/8	17	.53	.71	.91
3109 08 21	5/16	R1/2	21	.53	.77	.91
3109 60 13	3/8	R1/4	15	.63	.87	1.04
3109 60 17	3/8	R3/8	17	.63	.87	1.04
3109 62 13	1/2	R1/4	20	.87	1.22	1.38
3109 62 17	1/2	R3/8	20	.87	1.22	1.38
3109 62 21	1/2	R1/2	24	.87	1.12	1.38

3109 Male Elbow Metric Tube to Male NPT

PART NO.	ØD MM	C NPT	F MM	G MM	H IN	L IN
3109 04 11	4	1/8	11	.33	.53	.55
3109 04 14	4	1/4	14	.33	.55	.55
3109 06 11	6	1/8	11	.41	.61	.63
3109 06 14	6	1/4	14	.41	.63	.63
3109 08 11	8	1/8	11	.53	.75	.91
3109 08 14	8	1/4	14	.53	.71	.91
3109 08 18	8	3/8	18	.53	.73	.91
3109 10 14	10	1/4	15	.63	.91	1.04
3109 10 18	10	3/8	18	.63	.87	1.04
3109 10 22	10	1/2	22	.63	.91	1.04
3109 12 18	12	3/8	18	.75	.98	1.22
3109 12 22	12	1/2	22	.75	1.02	1.22

We recommend the use of an extra-flat wrench.

3109 Male Elbow Metric Tube to Male BSPT

PART NO.	ØD MM	C BSPT	F MM	G MM	H MM	L MM
3109 04 10	4	R1/8	10	8.5	13.5	14
3109 04 13	4	R1/4	14	8.5	14	14
3109 04 17	4	R3/8	17	8.5	13.5	14
3109 06 10	6	R1/8	10	10.5	15.5	16
3109 06 13	6	R1/4	14	10.5	16	16
3109 06 17	6	R3/8	17	10.5	16	16
3109 06 21	6	R1/2	21	10.5	16.5	16
3109 08 10	8	R1/8	10	13.5	19	23
3109 08 13	8	R1/4	14	13.5	18	23
3109 08 17	8	R3/8	17	13.5	18	23
3109 08 21	8	R1/2	21	13.5	19.5	23
3109 10 10	10	R1/8	15	16	23	26.5
3109 10 13	10	R1/4	15	16	22	26.5
3109 10 17	10	R3/8	17	16	22	26.5
3109 10 21	10	R1/2	21	16	22	26.5
3109 12 13	12	R1/4	15	19	25	31
3109 12 17	12	R3/8	17	19	25	31
3109 12 21	12	R1/2	21	19	25	31
3109 14 17	14	R3/8	20	22	30.5	35.5
3109 14 21	14	R1/2	24	22	28.5	35.5
3109 16 17	16	R3/8	27	27	53	39
3109 16 21	16	R1/2	27	27	53	39

WARNING These products can expose you to chemicals including LEAD which is known to the state of California to cause cancer.

[Click here for CADs, Product Specifications or to Configure Parts Online](#)

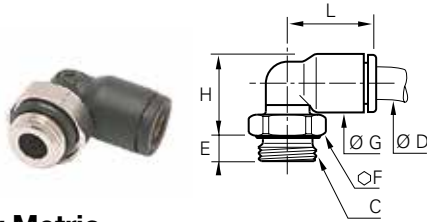

**3199 Male Elbow Metric
Tube to BSPP or Metric**

PART NO.	D MM	C BSPP/ METRIC	E MM	F MM	G MM	H MM	L MM
3199 03 09	3	M3X0.5	2.5	8	8.5	15	14.5
3199 03 19	3	M5X0.8	3.5	8	8.5	13.5	14.5
3199 04 09	4	M3X0.5	2.5	8	8.5	15	14.5
3199 04 19	4	M5X0.8	3.5	8	8.5	13.5	14
3199 04 55	4	M7X1	4.5	10	8.5	15	14
3199 04 10	4	G1/8	5	13	8.5	13	14
3199 04 13	4	G1/4	5.5	16	8.5	13	14
3199 06 19	6	M5X0.8	3.5	8	10.5	15.5	16
3199 06 55	6	M7X1	4.5	10	10.5	17.5	16
3199 06 60	6	M10X1	5	13	10.5	15	14
3199 06 67	6	M12X1.5	5.5	15	10.5	15	16
3199 06 10	6	G1/8	5	13	10.5	15	16
3199 06 13	6	G1/4	5.5	16	10.5	15	16
3199 06 17	6	G3/8	5.5	20	10.5	15.5	16
3199 06 21	6	G1/2	7	24	10.5	16	16
3199 08 60	8	M10X1	5	13	13.5	20.5	23
3199 08 67	8	M12X1.5	5.5	15	13.5	19.5	23
3199 08 10	8	G1/8	4.5	13	13.5	20.5	23
3199 08 13	8	G1/4	5.5	16	13.5	18.5	23
3199 08 17	8	G3/8	5.5	20	13.5	18.5	23
3199 08 21	8	G1/2	7	24	13.5	19	23
3199 10 13	10	G1/4	5.5	16	16	23.5	26.5
3199 10 17	10	G3/8	5.5	20	16	22	26.5
3199 10 21	10	G1/2	7.5	24	16	22	26.5
3199 12 13	12	G1/4	5.5	16	19	26.5	31
3199 12 17	12	G3/8	5.5	20	19	25	31
3199 12 21	12	G1/2	7	24	19	25	31
3199 14 17	14	G3/8	5.5	20	22	32.5	35.5
3199 14 21	14	G1/2	7	24	22	27	35.5
3199 16 17	16	G3/8	7.5	27	27	54.5	39
3199 16 21	16	G1/2	9	27	27	54.5	39

We recommend the use of an extra-flat wrench.

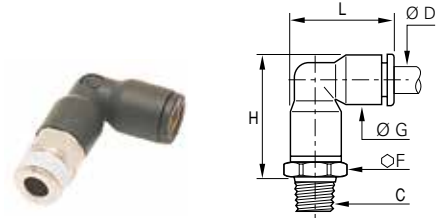

**3129 Extended Male Elbow
Fractional Inch Tube to Male NPT**

PART NO.	ØD IN	C NPT	F MM	G IN	H IN	L IN
3129 53 11	1/8	1/8	11	.33	.91	.75
3129 53 14	1/8	1/4	14	.33	.93	.75
3129 04 11	5/32	1/8	11	.33	.91	.75
3129 04 14	5/32	1/4	14	.33	.93	.75
3129 56 11	1/4	1/8	11	.43	1.12	.93
3129 56 14	1/4	1/4	14	.43	1.08	.93
3129 56 18	1/4	3/8	17	.43	1.12	.93
3129 08 11	5/16	1/8	13	.53	1.32	1.16
3129 08 14	5/16	1/4	14	.53	1.28	1.16
3129 60 11	3/8	1/8	17	.63	1.40	1.34
3129 60 14	3/8	1/4	17	.63	1.41	1.33
3129 60 18	3/8	3/8	18	.63	1.45	1.33

**3129 Extended Male Elbow Metric
Tube to Male BSPT**

PART NO.	ØD MM	C BSPT	E MM	F MM	H MM	L MM
3129 04 10	4	R1/8	10	8.5	23	19
3129 04 13	4	R1/4	14	8.5	23.5	19
3129 06 10	6	R1/8	10	10.5	27	22.5
3129 06 13	6	R1/4	14	10.5	27.5	22.5
3129 08 10	8	R1/8	13	13.5	34.5	29.5
3129 08 13	8	R1/4	14	13.5	32.5	29.5
3129 08 17	8	R3/8	17	13.5	33	29.5
3129 10 13	10	R1/4	15	16	39.5	34.5
3129 10 17	10	R3/8	17	16	39.5	34.5
3129 10 21	10	R1/2	21	16	39.5	34.5
3129 12 13	12	R1/4	19	19	45.5	40.5
3129 12 17	12	R3/8	19	19	45.5	40.5
3129 12 21	12	R1/2	21	19	45.5	40.5
3129 14 17	14	R3/8	21	22	51.5	46.5
3129 14 21	14	R1/2	21	22	51.5	46.5

3129 is designed to allow very close assembly with 3109 male elbow.

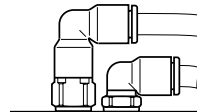

WARNING These products can expose you to chemicals including LEAD which is known to the state of California to cause cancer.

[Click here for CADs, Product Specifications or to Configure Parts Online](#)

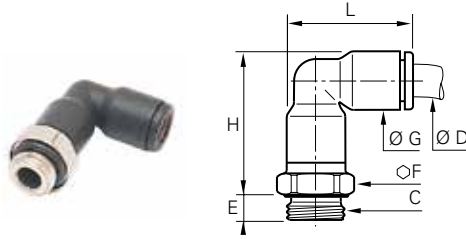

**3169 Extended Male Elbow
UNF, BSPP, M5 or M7**

PART NO.	ØD IN	C UNF/ METRIC	E IN	F MM	G IN	H IN	L IN
3169 53 20	1/8	10-32	.20	8	.33	.91	.75
3169 04 20	5/32	10-32	.20	8	.33	.91	.75
3169 56 20	1/4	10-32	.20	11	.33	1.10	.93
3169 56 55	1/4	M7	.18	9	.43	1.17	.93

PART NO.	ØD MM	C BSPP/ METRIC	E IN	F MM	G IN	H IN	L IN
3169 04 19	4	M5X0.8	3.5	8	8.5	23	19
3169 04 10	4	G1/8	5	13	8.5	22.5	19
3169 04 13	4	G1/4	5.5	16	8.5	22.5	19
3169 06 19	6	M5X0.8	3.5	10	10.5	27.5	23
3169 06 55	6	M7X1	4.5	10	10.5	26	23
3169 06 10	6	G1/8	5	13	10.5	27	23
3169 06 13	6	G1/4	5.5	16	10.5	27	23
3169 08 10	8	G1/8	5	13	13.5	36	29.5
3169 08 13	8	G1/4	5.5	16	13.5	33	29.5
3169 08 17	8	G3/8	5.5	20	13.5	33	29.5
3169 10 13	10	G1/4	5.5	16	16	40.5	34.5
3169 10 17	10	G3/8	5.5	20	16	40.5	34.5
3169 10 21	10	G1/2	7.5	24	16	40.5	34.5
3169 12 13	12	G1/4	5.5	19	19	44.5	40.5
3169 12 17	12	G3/8	5.5	20	19	42	40.5
3169 12 21	12	G1/2	7.5	24	19	42	40.5
3169 14 17	14	G3/8	5.5	22	22	51	46.5
3169 14 21	14	G1/2	7.5	24	22	48.5	46.5
3169 16 17	16	G3/8	7.5	27	27	82.5	52
3169 16 21	16	G1/2	9	27	27	82.5	52

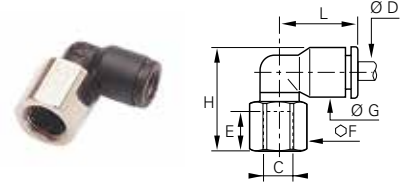

3009 Female Elbow Fractional Inch Tube to NPT

PART NO.	ØD IN	C NPT/UNF	F MM	G IN	H IN	E IN	L IN
3009 53 20	1/8	10-32	8	.33	.73	.24	.57
3009 53 11	1/8	1/8	13	.33	-	.37	.57
3009 53 14	1/8	1/4	13	.33	1.06	.55	.57
3009 55 11*	3/16	1/8	13	.33	1.02	.37	.90
3009 04 11	5/32	1/8	13	.33	.91	.37	.55
3009 04 14	5/32	1/4	16	.33	1.08	.55	.55
3009 04 20	5/32	10-32	8	.33	.73	.24	.57
3009 56 11	1/4	1/8	13	.43	1.02	.37	.71
3009 56 14	1/4	1/4	16	.43	1.18	.55	.71
3009 56 18	1/4	3/8	22	.43	1.18	.55	.71
3009 56 20	1/4	10-32	10	.43	.91	.24	.71
3009 08 11	5/16	1/8	13	.53	1.12	.37	.91
3009 08 14	5/16	1/4	16	.53	1.28	.55	.91
3009 60 11	3/8	1/8	16	.63	1.24	.37	1.04
3009 60 14	3/8	1/4	16	.63	1.52	.55	1.04
3009 60 18	3/8	3/8	22	.63	1.44	.55	1.04
3009 60 22	3/8	1/2	27	.63	1.58	.77	1.04
3009 62 14	1/2	1/4	19	.87	1.77	.55	1.40
3009 62 18	1/2	3/8	22	.87	1.88	.65	1.38
3009 62 22	1/2	1/2	27	.87	1.91	.77	1.40

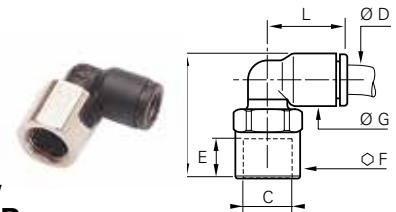

**3192 Female Elbow
Metric Tube to BSPP**

PART NO.	ØD MM	C BSPP	E MM	F MM	G MM	H MM	L MM
3192 04 10	4	G1/8	8.5	13	8.5	23	14
3192 04 13	4	G1/4	11.5	16	8.5	27	14
3192 06 10	6	G1/8	8.5	13	10.5	25	16
3192 06 13	6	G1/4	11.5	16	10.5	29	16
3192 08 10	8	G1/8	8.5	13	13.5	28	23
3192 08 13	8	G1/4	11.5	16	13.5	32	23
3192 08 17	8	G3/8	12	19	13.5	33	23
3192 10 13	10	G1/4	11	16	16	34.5	26.5
3192 10 17	10	G3/8	12	19	16	35	26.5
3192 10 21	10	G1/2	16	24	16	41	26.5
3192 12 13	12	G1/4	11	16	19	38	30.5
3192 12 17	12	G3/8	12	19	19	38.5	30.5
3192 12 21	12	G1/2	16	24	19	43.5	30.5

⚠ **WARNING** These products can expose you to chemicals including LEAD which is known to the state of California to cause cancer.

Click here for CADs, Product Specifications or to Configure Parts Online

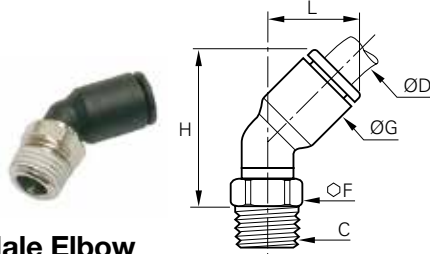

3133/3113 45° Male Elbow Fractional Inch Tube to Male NPT, UNF or M7

PART NO.	ØD IN	C NPT/UNF/M7	F MM	G IN	H IN	L IN
3133 53 20	1/8	10-32	8	.35	.91	.49
3113 53 08	1/8	1/16	10	.35	.83	.49
3113 53 11	1/8	1/8	11	.35	.81	.49
3113 53 14	1/8	1/4	14	.35	.83	.49
3113 55 11*	3/16	1/8	11	.43	1.06	.67
3113 04 11	5/32	1/8	11	.35	.83	.51
3113 04 14	5/32	1/4	14	.35	.85	.51
3113 04 20	5/32	10-32	8	.43	1.06	.57
3113 56 20	1/4	10-32	8	.35	.92	.51
3113 56 11	1/4	1/8	11	.43	.98	.57
3113 56 14	1/4	1/4	14	.43	.98	.57
3113 08 11	5/16	1/8	11	.53	1.16	.75
3113 08 14	5/16	1/4	14	.53	1.10	.75
3113 08 18	5/16	3/8	18	.53	1.14	.75
3113 60 11	3/8	1/8	15	.63	1.36	.90
3113 60 14	3/8	1/4	17	.63	1.36	.91
3113 60 18	3/8	3/8	18	.63	1.36	.91

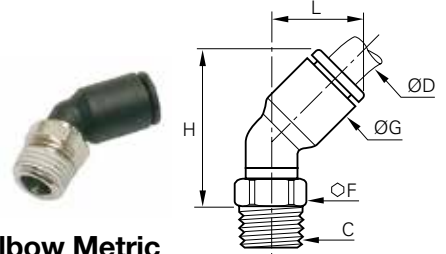

3113 45° Male Elbow Metric Tube to Male BSPT

PART NO.	ØD MM	C BSPT	F MM	G MM	H MM	L MM
3113 04 10	4	R1/8	10	9	24.5	13
3113 06 10	6	R1/8	10	11	28	14.5
3113 06 13	6	R1/4	14	11	30	14.5
3113 08 10	8	R1/8	10	13.5	33.5	19.5
3113 08 13	8	R1/4	14	13.5	33.5	19.5
3113 08 17	8	R3/8	17	13.5	33.5	19.5
3113 10 13	10	R1/4	15	16	38.5	23
3113 10 17	10	R3/8	17	16	39	23
3113 10 21	10	R1/2	21	16	40.5	23
3113 12 13	12	R1/4	15	19	44	26
3113 12 17	12	R3/8	17	19	44	26
3113 12 21	12	R1/2	21	19	46	26



Prevents excessive angular loads on tubing which can cause kinking and distortion of the tube.

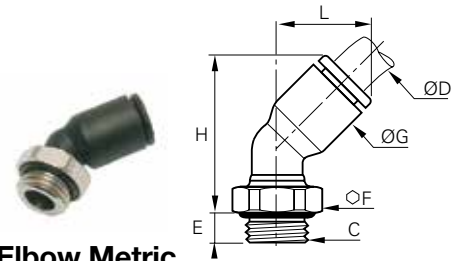

3133 45° Male Elbow Metric Tube to Male BSPP or M5

PART NO.	ØD MM	C BSPP/M5	E MM	F MM	G MM	H MM	L MM
3133 04 19	4	M5X0.8	3.5	8	9	23	13
3133 04 10	4	G1/8	4.5	13	9	25	13
3133 06 19	6	M5X0.8	3.5	8	11	30	14.5
3133 06 10	6	G1/8	4.5	13	11	28.5	14.5
3133 06 13	6	G1/4	5.5	16	11	29.5	14.5
3133 08 10	8	G1/8	4.5	13	13.5	36	19.5
3133 08 13	8	G1/4	5.5	16	13.5	34.5	19.5
3133 08 17	8	G3/8	5.5	20	13.5	34.5	19.5
3133 10 13	10	G1/4	5.5	16	16	40.5	23
3133 10 17	10	G3/8	5.5	20	16	39	23
3133 10 21	10	G1/2	7	24	16	41	23
3133 12 13	12	G1/4	5.5	16	19	46	26
3133 12 17	12	G3/8	5.5	20	19	44.5	26
3133 12 21	12	G1/2	7	24	19	46	26

WARNING These products can expose you to chemicals including LEAD which is known to the state of California to cause cancer.

[Click here for CADs, Product Specifications or to Configure Parts Online](#)

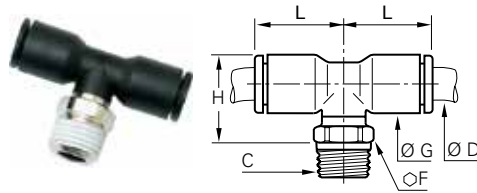

3108 Male Branch Tee Fractional Inch Tube to Male NPT or UNF to Tube

PART NO.	ØD IN	C NPT/UNF	F MM	G IN	H IN	L IN
3108 53 20	1/8	10-32	8	.33	.61	.57
3108 53 08	1/8	1/16	10	.33	.61	.57
3108 53 11	1/8	1/8	11	.33	.61	.57
3108 53 14	1/8	1/4	14	.33	.63	.57
3108 04 20	5/32	10-32	8	.33	.71	.55
3108 04 11	5/32	1/8	11	.33	.61	.55
3108 04 14	5/32	1/4	14	.33	.63	.55
3108 55 11*	3/16	1/8	11	.43	.67	.85
3108 56 11	1/4	1/8	11	.43	.67	.71
3108 56 14	1/4	1/4	14	.43	.63	.71
3108 56 18	1/4	3/8	18	.43	.65	.71
3108 08 11	5/16	1/8	11	.53	.87	.91
3108 08 14	5/16	1/4	14	.53	.83	.91
3108 08 18	5/16	3/8	18	.53	.85	.91
3108 60 11	3/8	1/8	15	.63	.99	1.04
3108 60 14	3/8	1/4	15	.63	.99	1.04
3108 60 18	3/8	3/8	18	.63	.95	1.04
3108 60 22	3/8	1/2	22	.63	.98	1.04
3108 62 14	1/2	1/4	20	.87	1.22	1.38
3108 62 18	1/2	3/8	20	.87	1.22	1.38
3108 62 22	1/2	1/2	24	.87	1.12	1.38

* Collet technology – bare brass.

3108 Male Branch Tee Metric Tube to Male NPT

PART NO.	ØD MM	C NPT	F MM	G IN	H IN	L IN
3108 04 11	4	1/8	11	.33	.61	.55
3108 04 14	4	1/4	14	.33	.63	.55
3108 06 11	6	1/8	11	.43	.69	.63
3108 06 14	6	1/4	14	.43	.71	.63
3108 08 11	8	1/8	11	.53	.87	.91
3108 08 14	8	1/4	14	.53	.83	.91
3108 08 18	8	3/8	18	.53	.85	.91
3108 10 14	10	1/4	15	.63	.98	1.04
3108 10 18	10	3/8	18	.63	.95	1.04
3108 10 22	10	1/2	22	.63	.98	1.04
3108 12 18	12	3/8	18	.87	1.06	1.22
3108 12 22	12	1/2	22	.87	.98	1.22

We recommend the use of an extra-flat wrench.

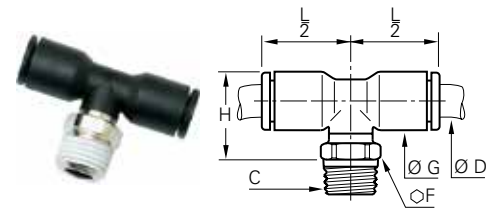

3108 Male Branch Tee Metric Tube to Male BSPT

PART NO.	ØD MM	C BSPT	F MM	G MM	H MM	L MM
3108 04 10	4	R1/8	10	8.5	15.5	14
3108 04 13	4	R1/4	14	8.5	16	14
3108 06 10	6	R1/8	10	10.5	17.5	16
3108 06 13	6	R1/4	14	10.5	18	16
3108 08 10	8	R1/8	10	13.5	22	23
3108 08 13	8	R1/4	14	13.5	21	23
3108 08 17	8	R3/8	17	13.5	21	23
3108 10 13	10	R1/4	15	16	24	26.5
3108 10 17	10	R3/8	17	16	24	26.5
3108 10 21	10	R1/2	21	16	24	26.5
3108 12 13	12	R1/4	15	19	27	31
3108 12 17	12	R3/8	17	19	27	31
3108 12 21	12	R1/2	21	19	27	31
3108 14 17	14	R3/8	20	22	30.5	35.5
3108 14 21	14	R1/2	24	22	28.5	35.5
3108 16 17	16	R3/8	27	27	53	38.5
3108 16 21	16	R1/2	27	27	53	38.5

3108 Male Branch Tee Fractional Inch Tube to Male BSPT

PART NO.	ØD IN	C BSPT	F MM	G IN	H IN	L IN
3108 53 10	1/8	R1/8	10	.34	.61	.55
3108 04 10	5/32	R1/8	10	.34	.61	.55
3108 04 13	5/32	R1/4	14	.34	.63	.55
3108 55 10	3/16	R1/8	11	.43	.67	.85
3108 55 13	3/16	R1/4	14	.43	.67	.85
3108 56 10	1/4	R1/8	10	.43	.67	.71
3108 56 13	1/4	R1/4	14	.43	.63	.71
3108 08 10	5/16	R1/8	10	.53	.87	.91
3108 08 13	5/16	R1/4	14	.53	.83	.91
3108 08 17	5/16	R3/8	17	.53	.83	.91
3108 60 13	3/8	R1/4	15	.63	.95	1.04
3108 60 17	3/8	R3/8	17	.63	.95	1.04
3108 60 21	3/8	R1/2	21	.63	.95	1.04
3108 62 21	1/2	R1/2	24	.87	1.12	1.26
3108 62 14	1/2	R1/4	30	.87	1.24	1.38

* Collet technology – bare brass.

We recommend the use of an extra-flat wrench.

WARNING These products can expose you to chemicals including LEAD which is known to the state of California to cause cancer.

[Click here for CADs, Product Specifications or to Configure Parts Online](#)

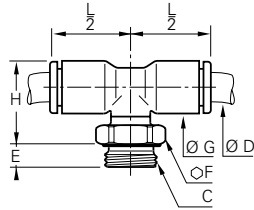

**3198 Male Branch Tee Metric
Tube to BSPP or M5**

PART NO.	ØD MM	C BSPP/M5	E MM	F MM	G MM	H MM	L MM
3198 04 19	4	M5X0.8	3.5	8	8.5	17.5	14
3198 04 10	4	G1/8	5	13	8.5	15	14
3198 04 13	4	G1/4	5.5	16	8.5	15	14
3198 06 19	6	M5X0.8	3.5	8	10.5	19.5	16
3198 06 10	6	G1/8	5	13	10.5	17	16
3198 06 13	6	G1/4	5.5	16	10.5	17	16
3198 08 10	8	G1/8	4.5	13	13.5	23.5	23
3198 08 13	8	G1/4	5.5	16	13.5	21.5	23
3198 08 17	8	G3/8	5.5	20	13.5	21.5	23
3198 10 13	10	G1/4	5.5	16	16	26	26.5
3198 10 17	10	G3/8	5.5	20	16	24	26.5
3198 10 21	10	G1/2	7.5	24	16	24	26.5
3198 12 13	12	G1/4	5.5	16	19	29	31
3198 12 17	12	G3/8	5.5	20	19	27	31
3198 12 21	12	G1/2	7	24	19	27	31
3198 14 17	14	G3/8	5.5	20	22	32.5	35.5
3198 14 21	14	G1/2	7	24	22	27	35.5
3198 16 17	16	G3/8	7.5	27	27	54.5	38.5
3198 16 21	16	G1/2	9	27	27	54.5	38.5

We recommend the use of an extra-flat wrench.

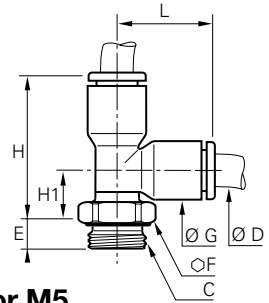

**3193 Male Run Tee Metric
Tube to Tube to Male BSPP or M5**

PART NO.	ØD MM	C BSPP/M5	E MM	F MM	G MM	H MM	H1 MM	L MM
3193 04 19	4	M5X0.8	3.5	8	8.5	26	11.5	14.5
3193 04 10	4	G1/8	5	13	8.5	23	8.5	14.5
3193 04 13	4	G1/4	5.5	16	8.5	23	8.5	14.5
3193 06 19	6	M5X0.8	3.5	8	10.5	29.5	12.5	17.5
3193 06 10	6	G1/8	5	13	10.5	27	10	17.5
3193 06 13	6	G1/4	5.5	16	10.5	27	10	17.5
3193 08 10	8	G1/8	4.5	13	13.5	36.5	14	23
3193 08 13	8	G1/4	5.5	16	13.5	34.5	12	23
3193 08 17	8	G3/8	5.5	20	13.5	34.5	12	23
3193 10 13	10	G1/4	5.5	16	16	42	15.5	26.5
3193 10 17	10	G3/8	5.5	20	16	40.5	14	26.5
3193 10 21	10	G1/2	7.5	24	16	40.5	14	26.5
3193 12 13	12	G1/4	5.5	16	19	48	17	31
3193 12 17	12	G3/8	5.5	20	19	46.5	15.5	31
3193 12 21	12	G1/2	7	24	19	46.5	15.5	31
3193 14 17	14	G3/8	5.5	20	22	56.5	21.5	35.5
3193 14 21	14	G1/2	7	24	22	51	16	35.5
3193 16 17	16	G3/8	7.5	27	27	79.5	41	38.5
3193 16 21	16	G1/2	9	27	27	79.5	41	38.5

We recommend the use of an extra-flat wrench.

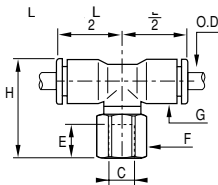

**3008 Female Branch Tee Fractional Inch
Tube to NPT**

PART NO.	ØD IN	C NPT	F MM	G IN	H IN	E IN	L IN
3008 53 11	1/8	1/8	13	.34	.99	.37	.57
3008 04 11	5/32	1/8	13	.33	.91	.37	.55
3008 04 14	5/32	1/4	16	.33	1.08	.55	.55
3008 56 11	1/4	1/8	13	.43	1.02	.37	.71
3008 56 14	1/4	1/4	16	.43	1.18	.55	.71
3008 08 11	5/16	1/8	13	.53	1.24	.37	.91
3008 08 14	5/16	1/4	16	.53	1.40	.55	.91
3008 60 14	3/8	1/4	16	.63	1.60	.55	1.04
3008 62 18	1/2	3/8	22	.87	1.88	.65	1.38

WARNING These products can expose you to chemicals including LEAD which is known to the state of California to cause cancer.

[Click here for CADs, Product Specifications or to Configure Parts Online](#)

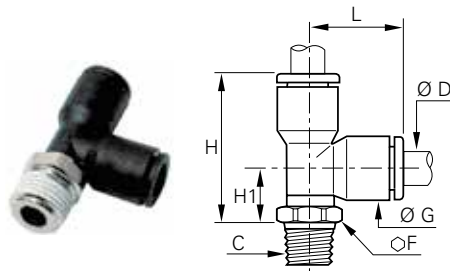

3103 Male Run Tee Fractional Inch Tube To Tube To Male NPT or UNF

PART NO.	ØD IN	C NPT/UNF	F MM	G IN	H IN	H1 IN	L IN
3103 53 20	1/8	10-32	8	.33	.92	.35	.57
3103 53 08	1/8	1/16	10	.33	.93	.35	.57
3103 53 11	1/8	1/8	11	.33	.93	.35	.57
3103 04 20	5/32	10-32	8	.33	1.02	.45	.57
3103 04 11	5/32	1/8	11	.33	.93	.53	.57
3103 04 14	5/32	1/4	14	.33	.94	.37	.57
3103 55 11*	3/16	1/8	11	.45	1.31	.45	.85
3103 56 11	1/4	1/8	11	.43	1.16	.45	.69
3103 56 14	1/4	1/4	14	.43	1.12	.41	.69
3103 56 18	1/4	3/8	18	.43	1.14	.43	.69
3103 08 11	5/16	1/8	11	.53	1.38	.49	.91
3103 08 14	5/16	1/4	14	.53	1.34	.45	.91
3103 08 18	5/16	3/8	18	.53	1.36	.47	.91
3103 60 11	3/8	1/8	15	.63	1.63	.60	1.04
3103 60 14	3/8	1/4	15	.63	1.63	.60	1.04
3103 60 18	3/8	3/8	18	.63	1.60	.55	1.04
3103 60 22	3/8	1/2	22	.63	1.63	.59	1.04
3103 62 14	1/2	1/4	20	.87	2.17	.79	1.38
3103 62 18	1/2	3/8	20	.87	2.17	.79	1.38
3103 62 22	1/2	1/2	24	.87	2.07	.79	1.38

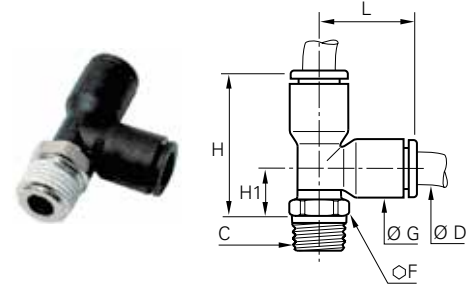

3103 Male Run Tee Metric Tube To Tube To Male BSPT

PART NO.	ØD MM	C BSPP/METRIC	E IN	F MM	G IN	H IN	L IN
3103 04 10	4	R1/8	10	8.5	23.5	9	14.5
3103 04 13	4	R1/4	14	8.5	24	9.5	14.5
3103 06 10	6	R1/8	10	10.5	27.5	10	17.5
3103 06 13	6	R1/4	14	10.5	28	10.5	17.5
3103 08 10	8	R1/8	10	13.5	35	12	23
3103 08 13	8	R1/4	14	13.5	34	11	23
3103 08 17	8	R3/8	17	13.5	34	11	23
3103 10 13	10	R1/4	15	16	40.5	14	26.5
3103 10 17	10	R3/8	17	16	40.5	14	26.5
3103 10 21	10	R1/2	21	16	40.5	14	26.5
3103 12 13	12	R1/4	15	19	46.5	15.5	31
3103 12 17	12	R3/8	17	19	46.5	15.5	31
3103 12 21	12	R1/2	21	19	46.5	15.5	31
3103 14 17	14	R3/8	20	22	55	19.5	35.5
3103 14 21	14	R1/2	24	22	52.5	17.5	35.5
3103 16 17	16	R3/8	27	27	78	27	38.5
3103 16 21	16	R1/2	27	27	78	27	38.5

WARNING These products can expose you to chemicals including LEAD which is known to the state of California to cause cancer.

[Click here for CADs, Product Specifications or to Configure Parts Online](#)

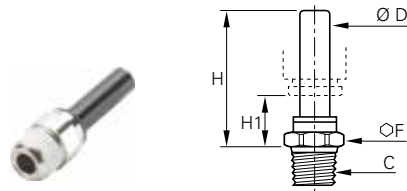

3121 Male Standpipe Fractional Inch – NPT

PART NO.	ØD IN	C NPT	F MM	H IN	H1 IN
3121 04 11	5/32	1/8	11	1.02	.57
3121 04 14	5/32	1/4	14	1.04	.59
3121 56 11	1/4	1/8	11	1.18	.61
3121 56 14	1/4	1/4	14	1.12	.57
3121 08 11	5/16	1/8	11	1.16	.43
3121 08 14	5/16	1/4	14	1.12	.39
3121 60 11	3/8	1/8	15	1.47	.81
3121 60 14	3/8	1/4	15	1.42	.67
3121 60 18	3/8	3/8	17	1.42	.61
3121 62 18	1/2	3/8	17	1.44	.37
3121 62 22	1/2	1/2	21	1.46	.39

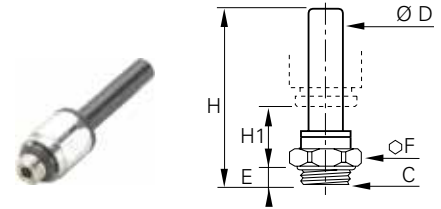

3131 Male Standpipe Fractional Inch – 10-32 UNF

PART NO.	ØD IN	C UNF	E IN	F MM	H IN	H1 IN
3131 04 20	5/32	10-32	.14	8	1.24	.14

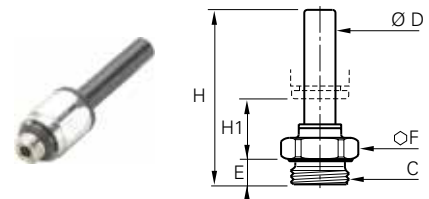

3131 Male Standpipe Fractional Inch – 10-32 UNF

PART NO.	ØD MM	C BSPP/M5	E MM	F MM	H MM	H1 MM
3131 04 19	4	M5X0.8	3.5	8	31	16
3131 04 10	4	G1/8	5	13	30	13.5
3131 04 13	4	G1/4	5.5	16	31	13.5
3131 06 10	6	G1/8	5	13	32	13.5
3131 06 13	6	G1/4	5.5	16	33	13.5
3131 08 10	8	G1/8	5	13	35.5	12.5
3131 08 13	8	G1/4	5.5	16	34.5	10.5
3131 08 17	8	G3/8	5.5	20	34.5	10.5
3131 10 13	10	G1/4	5.5	16	43.5	17.5
3131 10 17	10	G3/8	5.5	20	41.5	15.5
3131 10 21	10	G1/2	7.5	24	41.5	15.5
3131 12 17	12	G3/8	5.5	20	42	12
3131 12 21	12	G1/2	7	24	43.5	12
3131 14 17	14	G3/8	5.5	20	46.5	14
3131 14 21	14	G1/2	7	24	48	13.5

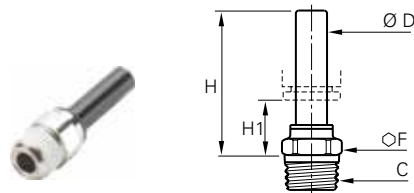

3121 Male Standpipe Metric – BSPT

PART NO.	ØD MM	C BSPT	F MM	H MM	H1 MM	W KG
3121 04 10	4	R1/8	10	26	14	.005
3121 04 13	4	R1/4	14	26.5	14.5	.013
3121 06 10	6	R1/8	10	28	14	.005
3121 06 13	6	R1/4	14	28.5	14.5	.013
3121 08 10	8	R1/8	10	29.5	11	.006
3121 08 13	8	R1/4	14	28.5	10	.008
3121 10 13	10	R1/4	15	36	15.5	.010
3121 10 17	10	R3/8	17	36	15.5	.012
3121 10 21	10	R1/2	21	36	15.5	.022
3121 12 17	12	R3/8	17	36.5	12	.022
3121 12 21	12	R1/2	21	36.5	12	.043
3121 14 21	14	R1/2	21	41	13.5	.043

WARNING: These products can expose you to chemicals including LEAD which is known to the state of California to cause cancer.

[Click here for CADs, Product Specifications or to Configure Parts Online](#)

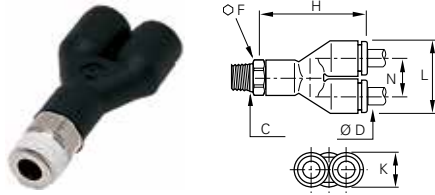

3148 “Y” Male Connector Fractional Inch Tube to NPT

PART NO.	ØD IN	C NPT	F MM	H IN	K IN	L IN	N IN
3148 04 11	5/32	1/8	11	1.28	.33	.69	.35
3148 04 14	5/32	1/4	14	1.30	.33	.69	.35
3148 56 11	1/4	1/8	11	1.61	.43	.87	.45
3148 56 14	1/4	1/4	14	1.56	.43	.87	.45
3148 60 14	3/8	1/4	17	2.24	.63	1.30	.67
3148 60 18	3/8	3/8	18	2.28	.63	1.30	.67

3148 “Y” Male Connector Metric Tube to BSPT

PART NO.	ØD MM	C BSPT	F MM	H IN	K IN	L IN	N IN
3148 04 10	4	R1/8	10	32.5	8.5	17.5	9
3148 04 13	4	R1/4	14	33	8.5	17.5	9
3148 06 10	6	R1/8	10	39.5	10.5	21.5	11
3148 06 13	6	R1/4	14	40	10.5	21.5	11
3148 08 10	8	R1/8	13	56.5	13.5	28	14.5
3148 08 13	8	R1/4	14	55.5	13.5	28	14.5
3148 08 17	8	R3/8	16	48.5	13.5	28	14.5
3148 10 13	10	R1/4	14	60	19	39	20
3148 10 17	10	R3/8	16	60.5	19	39	20
3148 10 21	10	R1/2	24	61	19	39	20
3148 12 17	12	R3/8	19	66	19	39	20
3148 12 21	12	R1/2	21	66	19	39	20

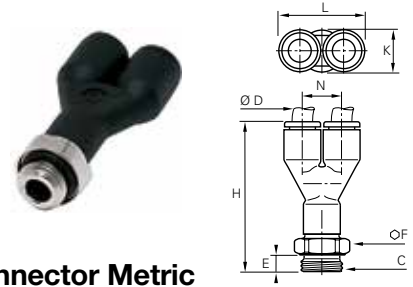

3158 “Y” Male Connector Metric Tube to BSPP or M5

PART NO.	ØD MM	C BSPP/M5	E MM	F MM	H MM	K MM	L MM	N MM
3158 04 19	4	M5X0.8	3.5	8	32.5	8.5	17.5	9
3158 04 10	4	G1/8	5	13	32	8.5	17.5	9
3158 04 13	4	G1/4	5.5	16	32	8.5	17.5	9
3158 06 19	6	M5X0.8	3.5	10	39.5	10.5	21.5	11
3158 06 10	6	G1/8	5	13	39	10.5	21.5	11
3158 06 13	6	G1/4	5.5	16	39	10.5	21.5	11
3158 08 10	8	G1/8	5	13	56	13.5	28	14.5
3158 08 13	8	G1/4	5.5	16	55	13.5	28	14.5
3158 08 17	8	G3/8	6	19	54	13.5	28	14.5
3158 10 13	10	G1/4	5.5	16	63.5	16	33	17
3158 10 17	10	G3/8	6	20	63.5	16	33	17
3158 10 21	10	G1/2	7	20	65	16	33	17
3158 12 17	12	G3/8	6	19	68	19	39	20
3158 12 21	12	G1/2	7	24	70	19	39	20

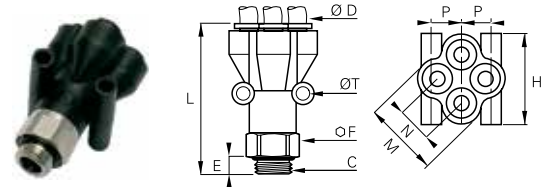

3132 Double “Y” Male Connector Metric Tube to BSPP

PART NO.	ØD MM	C BSPP/METRIC	E MM	F MM	H MM	L MM	M MM	N MM	P MM	ØT MM
3132 04 10	4	G1/8	5	13	25.5	41	21	10	8.5	3.7
3132 04 13	4	G1/4	5.5	16	25.5	40	21	10	8.5	3.7
3132 06 10	6	G1/8	5	19	31.5	52.5	26.5	12	10	3.7
3132 06 13	6	G1/4	5.5	19	31.5	53.5	26.5	12	10	3.7

WARNING These products can expose you to chemicals including LEAD which is known to the state of California to cause cancer.



Banjo Fittings

This range of fittings is ideal when access is only possible from above and orientation of the tube is required. This range of modular fittings includes single and multiple configurations, allowing wide flexibility of design.

Product Features:

Compact

- Compact design with minimum space between fittings
- Banjo bolt designed for maximum flow
- Easy access, even when fittings are close together
- Easy assembly and automatic sealing:
 - with pre-applied thread sealant on tapered threads
 - with an integral O-ring seal on parallel threads
- Safe operation: orientation of tube is ensured
- 100% leak-tested in production
- Date coding to guarantee quality and traceability
- Silicone-Free

Modular

- Effortless stacking of banjo bodies to allow construction
- of 2 to 6 outlets
- Orientable 360° for perfect alignment

Modular: tube diameters may be different

Markets:

- Automotive
- Textile
- Packaging
- Pneumatic
- Industrial

Applications:

- Robotics
- Automotive Process
- Pneumatics
- Semi-Conductors
- Textile
- Packaging

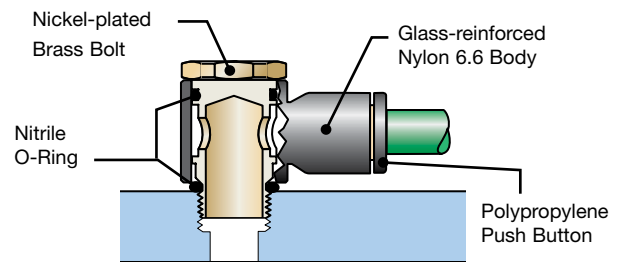

Specifications:

Compatible Fluids Compressed air
Other fluids: please consult us

Working Pressure 290 psi (20 bar) maximum

Vacuum Capability 28" Hg

Working Temperature -4° to 176° F (-20° to 80° C)

Installation Configurations

Thread and bore diameters for part numbers
3524 - 3527 - 3528 - 3529:

THREAD (C)	M5X0.8	G1/8	G1/4	G3/8	G1/2
(DN)	2.5	5.5	8.5	11	13

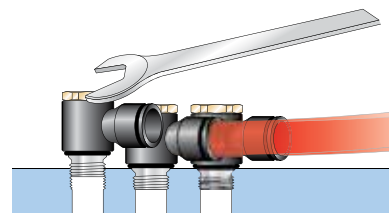
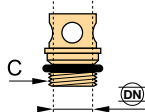

[Click here for CADs, Product Specifications or to Configure Parts Online](#)

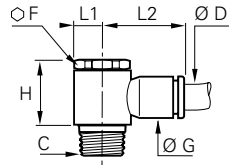

3018 Banjo Fractional Inch Tube to NPT

PART NO.	ØD IN	C NPT	F IN	G IN	H IN	L1 IN	L2 IN	W OZ
3018 04 11	5/32	1/8	13	.33	.73	.28	.73	.72
3018 55 11	3/16	1/8	14	.43	.73	.27	1.02	.89
3018 56 11	1/4	1/8	13	.43	.73	.28	.83	.75
3018 56 14	1/4	1/4	17	.43	.89	.37	.91	1.41
3018 56 18	1/4	3/8	21	.43	1.04	.43	1.12	2.60
3018 08 11	5/16	1/8	14	.43	.73	.27	.98	.23
3018 08 14	5/16	1/4	18	.43	.88	.37	1.06	2.25
3018 60 14	3/8	1/4	17	.63	.89	.37	1.12	2.34
3018 60 18	3/8	3/8	21	.63	1.04	.43	1.20	2.37

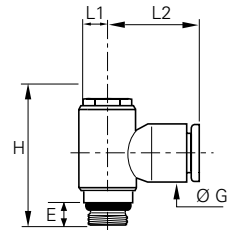

3118 Banjo Fractional Inch Tube To 10-32 UNF

PART NO.	ØD IN	C UNF	E IN	G IN	H IN	L1 IN	L2 IN	W OZ
3118 53 20	1/8	10-32	.16	.33	.79	.20	.65	.23
3118 04 20	5/32	10-32	.16	.33	.79	.20	.65	.23
3118 56 20	1/4	10-32	.16	.43	.79	.20	.73	.40

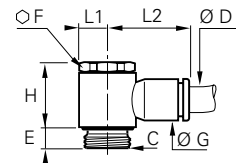

3118 Banjo Metric Tube to BSPP, M3 or M5

PART NO.	ØD MM	C BSPP/METRIC	E MM	F MM	G MM	H MM	L1 MM	L2 MM	W KG
3118 03 09*	3	M3X0.5	3	-	8.5	13	5	16	.007
3118 04 19*	4	M5X0.8	4	-	8.5	13	5	16	.007
3118 04 10	4	G1/8	4	13	8.5	17	7	18.5	.010
3118 06 19*	6	M5X0.8	4	-	10.5	13	7	18.5	.008
3118 06 10	6	G1/8	4	13	10.5	17	7	20	.011
3118 06 13	6	G1/4	5.5	17	10.5	21	9	22	.015
3118 08 10	8	G1/8	4	13	13.5	16.5	7	25	.022
3118 08 13	8	G1/4	5.5	17	13.5	21	9	27	.030
3118 08 17	8	G3/8	5.5	20	13.5	24.5	11	29	.049
3118 10 13	10	G1/4	5.5	17	16	21	9	29	.058
3118 10 17	10	G3/8	5.5	20	16	24.5	11	31	.061
3118 10 21	10	G1/2	8	25	19	27.5	13.5	36.5	.085
3118 12 17	12	G3/8	5.5	20	19	24.5	11.5	34.5	.067
3118 12 21	12	G1/2	8	25	19	27.5	13.5	36.5	.072

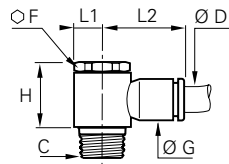

3018 Banjo Metric Tube to BSPT

PART NO.	ØD MM	C BSPT	F MM	G MM	H MM	L1 MM	L2 MM	W KG
3018 06 10	6	R1/8	13	10.5	18.5	7	20	.011
3018 06 13	6	R1/4	17	10.5	22.5	9.5	22	.015
3018 08 10	8	R1/8	13	13.5	18.5	7	25	.022
3018 08 13	8	R1/4	17	13.5	22.5	9.5	27	.030
3018 10 13	10	R1/4	17	16	22.5	9.5	29	.058
3018 10 17	10	R3/8	21	16	26.5	11	31	.061
3018 12 13	12	R1/4	21	19	26.5	11	34.5	.065
3018 12 17	12	R3/8	21	19	26.5	11	34.5	.067



Stacking

By stacking two and three compact bodies on top of each other using one bolt, a wide range of permutations of fittings, modules and manifolds can be constructed. Between two to six outlets in one modular construction are possible; the tube diameters may be different or the same. Parker Legris banjo bodies offer wide flexibility in the creation of fittings to meet the personalized requirements of the end user.

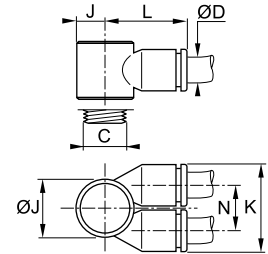
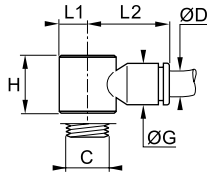

3538 Single Banjo Bodies Metric Tube to BSPP or M5

PART NO.	ØD MM	C BSPP/M5	G MM	H MM	L1 MM	L2 MM	W OZ
3538 04 19	4	M5X0.8	8.5	13	5	16	.004
3538 04 10	4	G1/8	10.5	14.5	7	18.5	.006
3538 06 19	6	M5X0.8	11	13	5	18.5	.004
3538 06 10	6	G1/8	10.5	14.5	7	20	.007
3538 06 13	6	G1/4	13.5	18	9.5	22	.009
3538 08 10	8	G1/8	13.5	14.5	7	25	.015
3538 08 13	8	G1/4	13.5	18	9.5	27	.020
3538 08 17	8	G3/8	13.5	21.5	11.5	29	.020
3538 10 13	10	G1/4	16	18	9.5	29	.035
3538 10 17	10	G3/8	16	21.5	11.5	31	.035
3538 12 17	12	G3/8	19	21.5	11.5	34.5	.040
3538 12 21	12	G1/2	19	22.5	13.5	36.5	.040

3549 Twin Banjo Bodies Metric Tube to BSPP or M5

PART NO.	ØD MM	C BSPP/M5	J MM	K MM	L MM	N MM	W KG
3549 04 13	4	G1/4	18.5	28	25	14.5	.011
3549 06 10	6	G1/8	14	22.5	20.5	12	.011
3549 06 13	6	G1/4	18.5	28	25	14.5	.012
3549 06 17	6	G3/8	22.5	33	28.5	17	.022
3549 08 13	8	G1/4	18.5	28	26	14.5	.017
3549 08 17	8	G3/8	22.5	33	29.5	17	.025

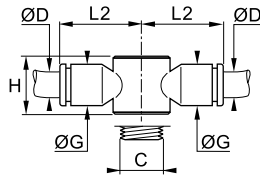

3539 Double Banjo Bodies Metric Tube to BSPP or M5

PART NO.	ØD MM	C BSPP/M5	G MM	H MM	L2 MM	W KG
3539 06 10	6	G1/8	10.5	14.35	20	.011
3539 06 13	6	G1/4	13.5	18	26	.012
3539 08 10	8	G1/8	13.5	14.5	25	.015
3539 08 13	8	G1/4	13.5	18	27	.017
3539 08 17	8	G3/8	16	21.5	30.5	.025
3539 10 17	10	G3/8	16	21.5	31	.025

[Click here for CADs, Product Specifications or to Configure Parts Online](#)

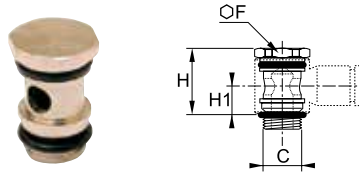

3527 Single Banjo Bolts BSPP or M5

PART NO.	C BSPP/M5	F MM	H MM	H1 MM	W KG
3527 00 19*	M5X0.8	-	17	7.5	.003
3527 00 10	G1/8	13	17	7.5	.014
3527 00 13	G1/4	17	21	9.5	.024
3527 00 17	G3/8	20	24.5	11	.038
3527 00 21	G1/2	25	27.5	11.5	.050

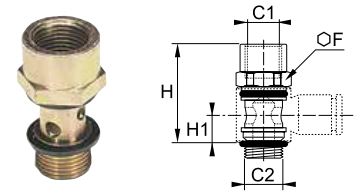

3524 Female Threaded Banjo Bolts BSPP or M5

PART NO.	C1 BSPP/M2	C BSPT	F MM	F1 MM	H MM	W KG
3524 00 19	M5X0.8	M5X0.8	8	17	7.5	.004
3524 00 10	G1/8	G1/8	13	24.5	7.5	.017
3524 00 13	G1/4	G1/4	17	33	9.5	.026
3524 00 17	G3/8	G3/8	20	37.5	11	.045
3524 00 21	G1/2	G1/2	25	42	11.5	.057

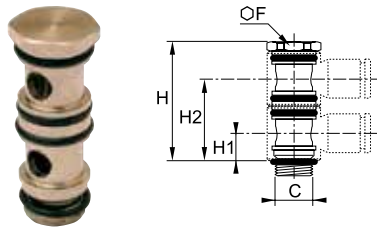

3528 Stacking Banjo for 2 Body High Modules BSPP or M5

PART NO.	C BSPP/M5	F MM	H MM	H1 MM	H2 MM	W KG
3528 00 19*	M5X0.8	-	24.5	7.5	18.5	.004
3528 00 10	G1/8	13	31	7.5	22	.020
3528 00 13	G1/4	17	39	9.5	27.5	.029
3528 00 17	G3/8	20	46	11	32.5	.048

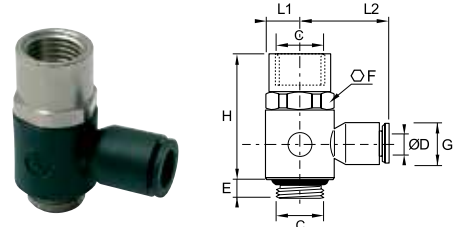

3124 Banjo with Female BSPP Bolt Metric Tube to BSPP or M5

PART NO.	ØD MM	C BSPP/M5	E MM	F MM	G MM	H MM	L1 MM	L2 MM	W KG
3124 04 10	4	G1/8	4	13	8.5	25.5	7	18.5	.012
3124 06 13	6	G1/4	5.5	17	10.5	33	9	22	.031
3124 08 17	8	G3/8	5.5	20	13.5	37.5	11	29	.056

This is a useful component allowing:

- The mounting of function fittings (sensors, flow controls and pressure reducers).
- Tapping off of a pneumatic supply from a pneumatic cylinder.

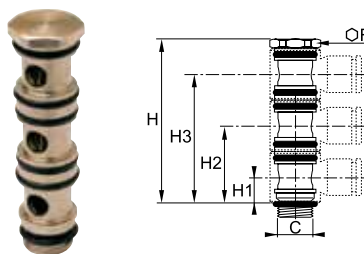

3529 Stacking Banjo for 3 Body High Modules BSPP

PART NO.	C BSPP	F MM	H MM	H1 MM	H2 MM	H3 MM	W KG
3529 00 10	G1/8	13	45.5	7.5	22	36	.026
3529 00 13	G1/4	17	54	9.5	27.5	45.5	.036
3529 00 17	G3/8	20	67.5	11	32.5	54	.059

[Click here for CADs, Product Specifications or to Configure Parts Online](#)

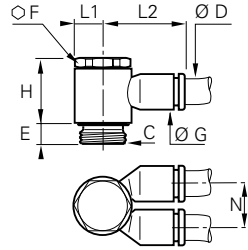

3149/3049 Twin Banjo Tube to NPT, UNF, BSPP or M5

PART NO.	ØD IN	C NPT/UNF	E IN	F MM	G IN	H IN	L1 IN	L2 IN	N IN	W OZ
3149 04 20	5/32	10-32	.16	-	.33	.63	.20	.61	.45	.28
3049 04 11	5/32	1/8	-	13	.43	.73	.28	.73	.57	.46
3049 56 11	1/4	1/8	-	13	.43	.73	.28	.73	.57	.46
3049 56 14	1/4	1/4	-	17	.43	.89	.37	1.04	.57	1.20
3049 60 14	3/8	1/4	-	21	.63	1.04	.43	1.22	.67	1.20
3049 60 18	3/8	3/8	-	21	.63	1.04	.43	1.22	.67	2.33

PART NO.	ØD MM	C BSPP/M5	E IN	F MM	G IN	H IN	L1 IN	L2 IN	N IN	W KG
3149 04 19*	4	M5X0.8	4	-	8.5	13	4.5	16	9	.008
3149 04 10	4	G1/8	4	13	10.5	16.5	7	18.5	11.5	.013
3149 06 10	6	G1/8	4	13	10.5	16.5	7	18.5	11.5	.013
3149 06 13	6	G1/4	5.5	17	13.5	21	9.5	27	14.5	.034
3149 08 13	8	G1/4	5.5	17	13.5	21	9.5	27	14.5	.034
3149 08 17	8	G3/8	5.5	20	16	24.5	11	31	17	.066
3149 10 17	10	G3/8	5.5	20	16	24.5	11	31	17	.066

*With screwdriver slot
This fitting provides two parallel outlets on the same side.

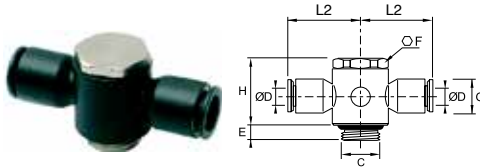

3119 Double Banjo Metric Tube to BSPP or M5

PART NO.	ØD MM	C BSPP/M5	E MM	F MM	G MM	H MM	L2 MM	W KG
3119 04 19*	4	M5X0.8	4	-	8.5	13	16	.005
3119 06 10	6	G1/8	4	13	11	17	20	.024
3119 06 13	6	G1/4	5.5	17	13.5	21	26.5	.031
3119 08 13	8	G1/4	5.5	17	13.5	21	27	.033
3119 08 17	8	G3/8	5.5	20	16	24.5	30.5	.052

*With screwdriver slot

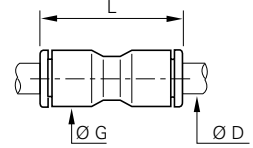

3106 Union Fractional Inch Tube to Tube

PART NO.	ØD IN	G IN	L IN	W OZ
3106 53 00	1/8	.34	.97	.11
3106 04 00	5/32	.33	.98	.07
3106 55 00	3/16	.43	1.44	.39
3106 56 00	1/4	.43	1.16	.14
3106 08 00	5/16	.53	1.50	.25
3106 60 00	3/8	.63	1.65	.40
3106 62 00	1/2	.87	2.17	.95

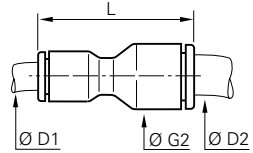

3106 Unequal Union Fractional Inch Tube to Tube

PART NO.	ØD1 IN	ØD2 IN	G2 IN	L IN	W KG
3106 53 04	1/8	5/32	.33	.96	.11
3106 53 56	1/8	1/4	.43	1.32	.34
3106 04 56	5/32	1/4	.43	1.16	.34
3106 56 08	1/4	5/16	.53	1.44	.40
3106 60 56	3/8	1/4	.63	1.61	.50
3106 60 62	3/8	1/2	.87	2.17	.55

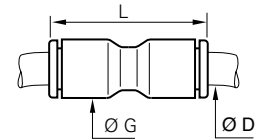

3106 Union Metric Tube to Tube

PART NO.	ØD MM	G MM	L MM	W KG
3106 03 00	3	8.5	25	.002
3106 04 00	4	8.5	25	.002
3106 06 00	6	10.5	28.5	.004
3106 08 00	8	13.5	38	.007
3106 10 00	10	16	42	.009
3106 12 00	12	19	50.5	.015
3106 14 00	14	22	56	.043
3106 16 00	16	27	60.5	.045

[Click here for CADs, Product Specifications or to Configure Parts Online](#)

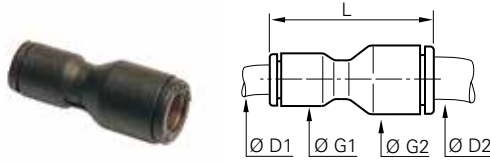

3106 Unequal Union Metric Tube to Tube

PART NO.	ØD1 MM	ØD2 MM	G1 MM	G2 MM	L MM	W KG
3106 03 04	3	4	8.5	8.5	25	.002
3106 04 06	4	6	8.5	11	28	.008
3106 04 08	4	8	13.5	13.5	38	.010
3106 06 08	6	8	13.5	13.5	38	.012
3106 06 10	6	10	16	16	42	.018
3106 08 10	8	10	16	16	42	.020
3106 08 12	8	12	19	19	50.5	.031
3106 10 12	10	12	19	19	50.5	.022
3106 12 14	12	14	22	22	56	.024
3106 12 16	12	16	27	27	61	.066

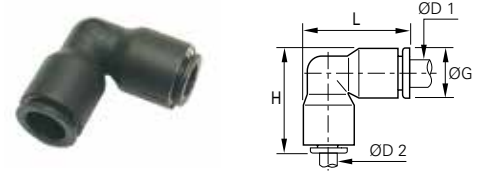

3102 Unequal Union Elbow Fractional Inch Tube to Tube

PART NO.	ØD1 IN	ØD2 IN	G1 IN	G2 IN	L IN	W OZ
3102 53 56	1/8	1/4	.43	.93	.93	.20
3102 04 56	5/32	1/4	.43	.93	.93	.25
3102 60 56	3/8	1/4	.63	1.30	1.33	.50
3102 60 62	3/8	1/2	.87	1.81	1.81	.65

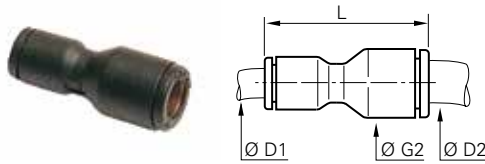

3106 Converters Metric to Fractional Inch

PART NO.	ØD1 IN	ØD2 IN	G2 IN	L IN	W OZ
3106 06 56	6	1/4	.43	1.18	.14
3106 60 10	3/8	10	.78	1.99	.40
3106 12 62	12	1/2	.87	2.25	.95

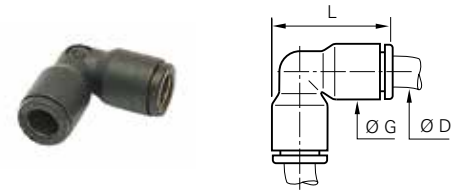

3102 Union Elbow Metric Tube to Tube

PART NO.	ØD MM	G MM	L MM	W KG
3102 04 00	4	8.5	19	.002
3102 06 00	6	10.5	22.5	.004
3102 08 00	8	13.5	29.5	.007
3102 10 00	10	16	34.5	.015
3102 12 00	12	19	40.5	.017
3102 14 00	14	22	46.5	.045
3102 16 00	16	27	52	.004

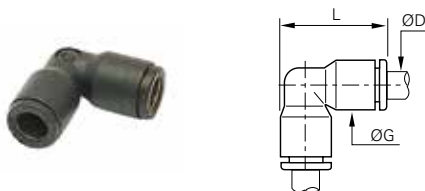

3102 Union Elbow Fractional Inch Tube to Tube

PART NO.	ØD IN	G IN	L IN	W OZ
3102 53 00	1/8	.33	.71	.11
3102 04 00	5/32	.33	.75	.07
3102 55 00	3/16	.43	1.07	.55
3102 56 00	1/4	.43	.93	.15
3102 08 00	5/16	.53	1.16	.25
3102 60 00	3/8	.63	1.33	.41
3102 62 00	1/2	.87	1.83	.65

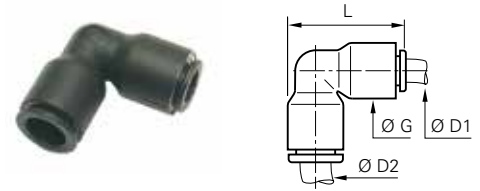

3102 Unequal Union Elbow Metric Tube to Tube

PART NO.	ØD1 MM	ØD2 MM	G MM	L MM	W KG
3102 04 06	4	6	10.5	22.5	.004
3102 06 08	6	8	13.5	29.5	.007
3102 08 10	8	10	16	34.5	.015
3102 10 12	10	12	19	40.5	.017

[Click here for CADs, Product Specifications or to Configure Parts Online](#)

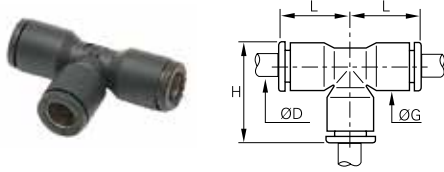

3104 Union Tee Fractional Inch Tube to Tube to Tube

PART NO.	ØD IN	G IN	H IN	L IN	W OZ
3104 53 00	1/8	.33	.75	.57	.15
3104 04 00	5/32	.33	.75	.57	.14
3104 55 00	3/16	.43	1.07	.85	.58
3104 56 00	1/4	.43	.89	.71	.22
3104 08 00	5/16	.53	1.16	.91	.32
3104 60 00	3/8	.63	1.34	1.02	.64
3104 62 00	1/2	.87	1.81	1.38	1.74

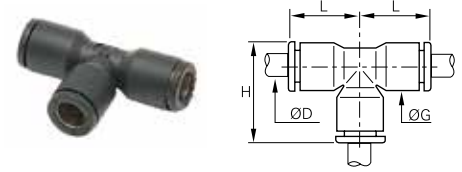

3104 Unequal Union Tee Fractional Tube to Tube to Tube

PART NO.	ØD1 IN	ØD2 IN	G1 IN	H IN	L IN	W KG
3104 53 56	1/8	1/4	.43	.93	.71	.20
3104 04 56	5/32	1/4	.43	.93	.71	.28
3104 56 53	1/4	1/8	.43	.93	.73	.35
3104 56 04	1/4	5/32	.43	.93	.73	.40
3104 56 60	1/4	3/8	.63	1.32	.96	.60
3104 60 56	3/8	1/4	.63	1.28	1.00	.65
3104 60 62	3/8	1/2	.87	1.81	1.38	.70
3104 62 56	1/2	1/4	.87	1.81	1.38	.73
3104 62 60	1/2	3/8	.87	1.81	1.38	.75

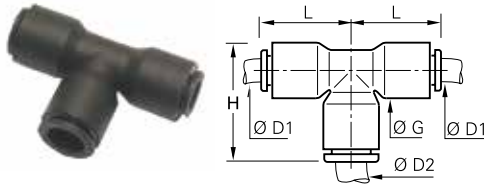

3104 Unequal Union Tee Metric Tube to Tube to Tube

PART NO.	ØD MM	G MM	H MM	L MM	W OZ
3104 03 00	3	8.5	19	14.5	.004
3104 04 00	4	8.5	19	14.5	.004
3104 06 00	6	10.5	23.5	18	.006
3104 08 00	8	13.5	29.5	23	.009
3104 10 00	10	16	34.5	26.5	.014
3104 12 00	12	19	40.5	31	.019
3104 14 00	14	22	46	35.5	.024
3104 16 00	16	27	52	39	.029

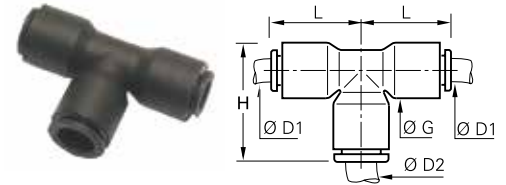

3104 Unequal Union Tee Metric Tube to Tube to Tube

PART NO.	ØD1 MM	ØD2 MM	G MM	H MM	L MM	W KG
3104 04 06	4	6	10.5	22.5	17.5	.006
3104 06 04	6	4	10.5	22.5	17.5	.006
3104 06 08	6	8	13.5	29.5	23	.009
3104 08 06	8	6	13.5	29.5	23	.009
3104 08 10	8	10	16	34.5	26.5	.014
3104 10 08	10	8	16	34.5	26.5	.019
3104 10 12	10	12	19	40.5	31	.019
3104 12 10	12	10	19	40.5	31	.019
3104 14 08	14	8	22	46	35.5	.034
3104 16 12	16	12	27	52.5	39	.036

[Click here for CADs, Product Specifications or to Configure Parts Online](#)

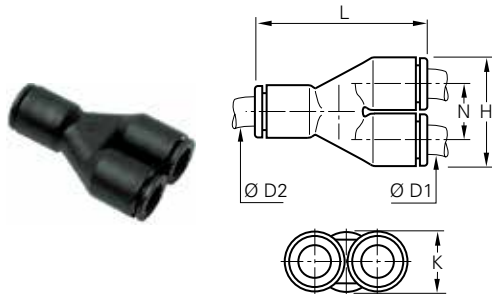

3140 “Y” Union Fractional Inch Tube to Tube

PART NO.	ØD1 IN	ØD2 IN	H IN	K IN	L IN	NK IN	W OZ
3140 53 00	1/8	1/8	.69	.33	1.12	.35	.16
3140 04 00	5/32	5/32	.69	.34	1.12	.35	.14
3140 55 00	3/16	3/16	.87	.34	1.77	.45	.10
3140 56 00	1/4	1/4	.87	.43	1.42	.45	.24
3140 08 00	5/16	5/16	1.10	.53	1.77	.57	.46
3140 60 00	3/8	3/8	1.30	.63	2.09	.67	.59
3140 62 00	1/2	1/2	1.77	.87	2.64	.91	.99

PART NO.	ØD1 IN	ØD2 IN	H IN	K IN	L IN	NK IN	W OZ
3140 53 56	1/8	1/4	.87	.43	1.42	.45	.20
3140 04 56	5/32	1/4	.87	.43	1.42	.45	.43
3140 56 60	1/4	3/8	1.30	.63	1.31	.67	.50

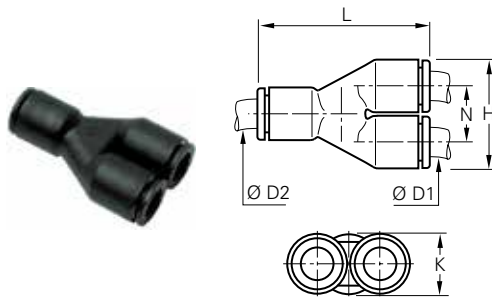

3140 “Y” Union Metric Tube to Tube

PART NO.	ØD1 MM	ØD2 MM	H MM	K MM	L MM	N MM	W KG
3140 04 00	4	4	17.5	8.5	28.5	9	.004
3140 06 00	6	6	21.5	10.5	35	11	.007
3140 08 00	8	8	28	13.5	45	14.5	.013
3140 10 00	10	10	33	16	53	17	.020
3140 12 00	12	12	39	19	57	20	.025

PART NO.	ØD1 MM	ØD2 MM	H MM	K MM	L MM	N MM	W KG
3140 04 06	4	6	17.5	10.5	33	9	.005
3140 06 08	6	8	22.5	13.5	41	11.5	.019
3140 08 10	8	10	28	16	47	14.5	.015
3140 10 12	10	12	33	19	57	17	.022

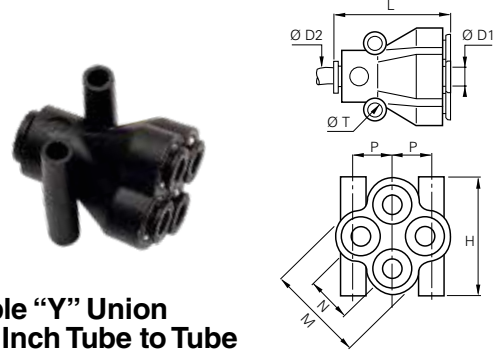

3144 Double “Y” Union Fractional Inch Tube to Tube

PART NO.	ØD1 IN	ØD2 IN	H IN	L IN	M IN	N IN	P IN	ØT IN	W OZ
3144 04 04	5/32	5/32	1.00	1.20	.83	.39	.34	.15	.95
3144 04 56	5/32	1/4	1.00	1.18	.83	.39	.34	.15	.95

ØT = I.D. of mounting hole (see page A31)

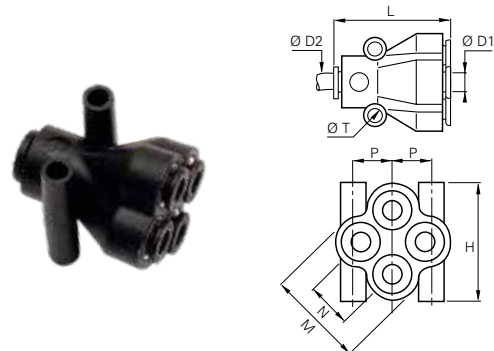

3144 Multiple “Y” Union Metric Tube to Tube

PART NO.	ØD1 MM	ØD2 MM	H MM	L MM	M MM	N MM	P MM	ØT MM	W KG
3144 04 04	4	4	25.5	30.5	21	10	8.5	3.7	.027
3144 06 06	6	6	31.5	37.5	26.5	12	10	3.7	.043
3144 04 06	4	6	25.5	30.5	21	10	8.5	3.7	.027
3144 06 08	6	8	31.5	38	26.5	12	10	3.7	.045

ØT = I.D. of mounting hole (see page A31)

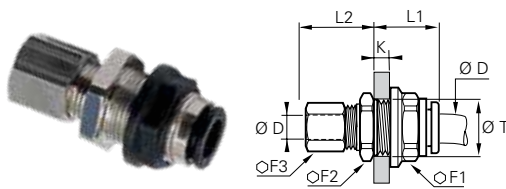

3146 Mixed Bulkhead Connector Metric Tube

PART NO.	ØD MM	F1 MM	F2 MM	F3 MM	K MAX MM	L1 MM	L2 MM	ØT MIN	W OZ
3146 04 00	4	13	13	10	7	17.5	17.5	10.5	.021
3146 06 00	6	15	17	13	8	19	18	12.5	.030
3146 08 00	8	18	19	14	8	20.5	20.5	15.5	.038
3146 10 00	10	22	22	19	8.5	23	24.5	18.5	.071
3146 12 00	12	26	25	22	8.5	27	25	22.5	.086
3146 14 00	14	29	29	24	10.5	27	27	25.5	.125

The plastic nut is fitted with an "O" ring to optimize sealing in relation to the panel.

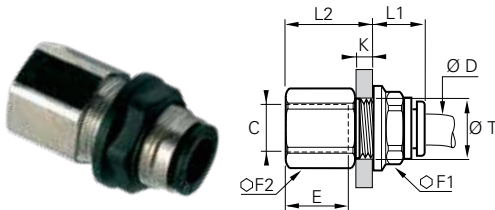

3036/3136 Female Bulkhead Connector Tube to NPT or BSPP

PART NO.	ØD IN	C NPT	E IN	F1 MM	F2 MM	K MAX IN	L1 IN	L2 IN	ØT MIN	W OZ
3036 53 11	1/8	1/8	.37	13	13	.28	.39	.73	.41	.75
3036 04 11	5/32	1/8	.37	13	13	.28	.39	.73	.41	.88
3036 04 14	5/32	1/4	.55	13	16	.32	.39	.95	.41	.99
3036 56 11	1/4	1/8	.37	18	17	.32	.45	.96	.61	1.23
3036 56 14	1/4	1/4	.55	18	17	.32	.45	.91	.61	1.41
3036 60 14	3/8	1/4	.55	22	22	.33	.55	.87	.73	2.57
3036 60 18	3/8	3/8	.55	22	22	.33	.55	1.02	.73	2.65

PART NO.	ØD MM	C BSPP	E MM	F1 MM	F2 MM	K MAX MM	L1 MM	L2 MM	ØT MIN	W KG
3136 04 10	4	G1/8	9.5	13	13	7	17.5	10.5	10.5	.025
3136 04 13	4	G1/4	13.5	16	13	7	17.5	14.5	10.5	.028
3136 06 10	6	G1/8	9.5	15	13	8	19	10.5	12.5	.035
3136 06 13	6	G1/4	13.5	17	13	7	19	14.5	12.5	.040
3136 06 17	6	G3/8	12	15	22	8	19	16	12.5	.041
3136 08 10	8	G1/8	9.5	17	18	8	20.5	10.5	15.5	.048
3136 08 13	8	G1/4	13.5	17	18	8	20.5	14.5	15.5	.055
3136 10 17	10	G3/8	14	22	22	8.5	23	16	20.5	.073
3136 12 17	12	G3/8	14	26	25	8.5	27	16	22.5	.092
3136 12 21	12	G1/2	18.5	26	26	8.5	27	21.5	22.5	.118
3136 16 17	16	G3/8	12	29	29	10.5	30	15	27.5	.008
3136 16 21	16	G1/2	15	29	29	10.5	30	19.5	27.5	.008

The plastic nut is fitted with an "O" ring to optimize sealing in relation to the panel.

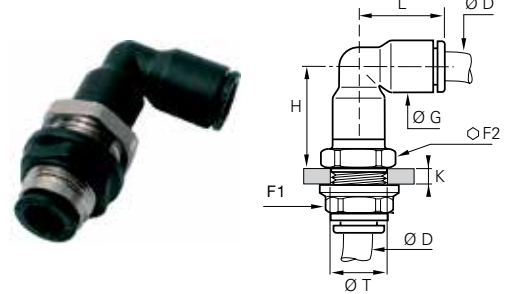

3139 Equal Bulkhead Elbow Tube to Tube

PART NO.	ØD IN	F1 IN	F2 MM	G IN	H IN	K MAX IN	L IN	ØT MIN IN	W OZ
3139 53 00	1/8	13	13	.35	.71	.28	.57	.41	.67
3139 04 00	5/32	13	13	.33	.83	.26	.67	.41	.67
3139 56 00	1/4	18	17	.43	.87	.32	.71	.61	.85
3139 08 00	5/16	18	18	.53	1.22	.31	.94	.61	1.23
3139 60 00	3/8	22	22	.63	1.08	.33	1.00	.73	2.80
3139 62 00	1/2	29	27	.87	1.54	.41	1.38	1.00	4.34

PART NO.	ØD MM	F1 MM	F2 MM	G MM	H MM	K MAX MM	L MM	ØT MIN MM	W KG
3139 04 00	4	13	13	8.5	21	6.5	17	10.5	.019
3139 06 00	6	15	15	10.5	24.5	7	19.5	12.5	.024
3139 08 00	8	18	18	13.5	31	8	24	15.5	.035
3139 10 00	10	22	22	16	36	8.5	28	18.5	.081
3139 12 00	12	26	26	19	42	8.5	33	22.5	.123
3139 14 00	14	29	29	25.5	48	10.5	37.5	25.5	.143

The plastic nut is fitted with an "O" ring to optimize sealing in relation to the panel.

[Click here for CADs, Product Specifications or to Configure Parts Online](#)

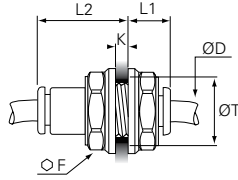

3116 Bulkhead Union Tube to Tube

PART NO.	ØD IN	F MM	K MAX IN	L1 IN	L2 IN	ØT MAX IN	W OZ	MAX TORQUE
3116 53 00	1/8	13	.22	.37	.61	.41	.64	11 LB. IN.
3116 55 00	3/16	15	.33	.55	.94	.47	.67	11 LB. IN.
3116 04 00	5/32	13	.22	.59	.39	.41	.67	11 LB. IN.
3116 56 00	1/4	16	.35	.37	.81	.53	.24	13 LB. IN.
3116 08 00	5/16	18	.57	.98	.53	.61	1.16	15 LB. IN.
3116 60 00	3/8	22	.57	.51	1.18	.73	.65	22 LB. IN.
3116 62 00	1/2	29	.81	.67	1.61	1.00	3.60	22 LB. IN.

PART NO.	ØD MM	F MM	K MAX IN	L1 IN	L2 IN	ØT MIN MM	W KG
3116 04 00	4	13	5.5	15	10	10.5	.018
3116 06 00	6	15	8.5	18	10.5	12.5	.029
3116 08 00	8	18	14.5	25	13.5	15.5	.037
3116 10 00	10	22	14.5	27.5	15.5	18.5	.084
3116 12 00	12	26	18.5	33	18	22.5	.102
3116 14 00	14	29	20.5	37.5	20.5	25.5	.135

The plastic nut is fitted with an "O" ring to optimize sealing in relation to the panel.

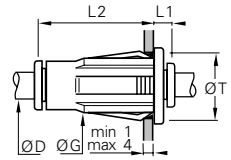

3156 Plug-In Bulkhead Union Fractional Inch Tube to Tube

PART NO.	ØD IN	G IN	L1 IN	L2 IN	ØT MIN IN	W OZ
3156 56 00	1/4	.93	.26	1.24	.75	.41
3156 08 00	5/16	1.02	.30	1.28	.87	.57
3156 60 00	3/8	1.34	.30	1.63	1.12	1.30

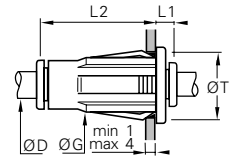

3156 Plug-In Bulkhead Union Metric Tube to Tube

PART NO.	ØD MM	G MM	L1 MM	L2 MM	ØT MIN MM	W KG
3156 06 00	6	9.91	6.60	31.50	19.05	.012
3156 08 00	8	6.60	7.62	32.51	22.10	.0167
3156 12 00	12	36.58	7.62	43.43	31.75	.040

To Facilitate Color Coding, Please Refer To Page A46 For Colored Caps.

Installation

1. Mark out the fixing hole
2. Make hole in panel

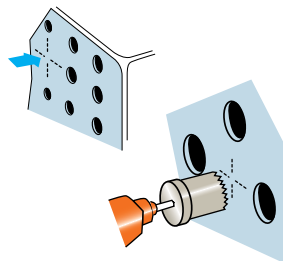

3. Simply push the fitting into place
4. To complete the installation
5. To identify circuits simply remove the black release button and replace with colored one

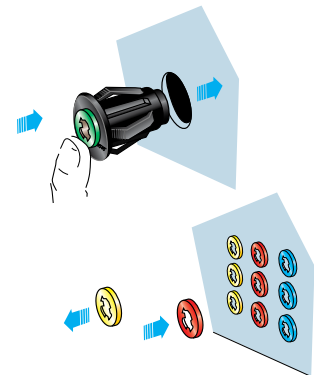

Minimum distance between fittings.
Diameter of fixing hole.

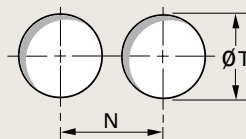

ØD	5/32	1/4	5/16	3/8	1/2
inches	5/8	3/4	7/8	1 1/8	1 1/4
mm	15.87	19.05	22.22	28.57	31.75
N in.89	1.00	1.08	1.34	1.50	
tolerance ØT :	+0.3-0.1				

[Click here for CADs, Product Specifications or to Configure Parts Online](#)

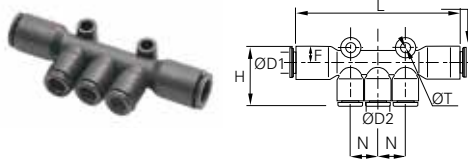

3304 Multiple Tee with Mounting Holes

PART NO.	ØD1 IN	ØD2 IN	H IN	L IN	N IN	ØT IN	W OZ
3304 56 04	1/4	5/32	.97	2.81	.45	.17	.81
3304 56 56	1/4	1/4	1.22	3.14	.61	.17	1.00
3304 08 04	5/16	5/32	.96	2.91	.45	.17	1.09
3304 60 56	3/8	1/4	1.34	3.21	.61	.17	2.05

PART NO.	ØD1 IN	ØD2 IN	H MM	L MM	N MM	ØT MM	W KG
3304 06 04	6	4	24.5	74	11.5	4.2	.023
3304 08 04	8	4	24.5	74	11.5	4.2	.031
3304 08 06	8	6	24.5	74	11.5	4.2	.033
3304 10 06	10	6	36	81	14.5	4.2	.058
3304 10 08	10	8	36	81	14.5	4.2	.060

ØT = I.D. of mounting hole

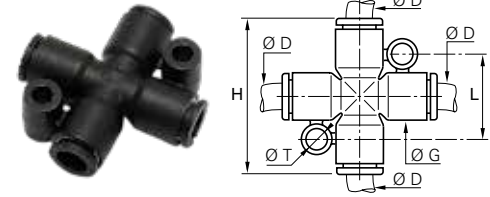

3107 Equal Cross

PART NO.	ØD IN	G IN	H IN	L IN	ØT IN	W OZ
3107 04 00	5/32	.43	1.42	.79	.17	.35
3107 55 00	3/16	.43	1.81	.79	.17	.71
3107 56 00	1/4	.43	1.40	.79	.17	.35
3107 08 00	5/16	.53	1.81	.89	.17	.71

PART NO.	ØD IN	G IN	H IN	L IN	ØT IN	W OZ
3107 04 00	5/32	.43	1.42	.79	.17	.35
3107 55 00	3/16	.43	1.81	.79	.17	.71
3107 56 00	1/4	.43	1.40	.79	.17	.35
3107 08 00	5/16	.53	1.81	.89	.17	.71

ØT = I.D. of mounting hole

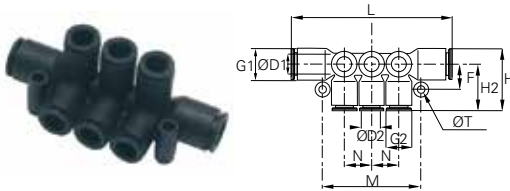

3306 Double Multiple Tee with Mounting Holes

PART NO.	ØD1 IN	ØD2 IN	F IN	G1 IN	G2 IN	H IN	L IN	N IN	M IN	ØT IN	W OZ
3306 56 04	1/4	5/32	.45	.53	.43	.73	2.84	.45	1.69	.17	.85
3306 56 56	1/4	1/4	.45	.53	.43	.73	2.84	.45	1.69	.17	1.25
3306 08 04	5/16	5/32	.45	.53	.43	.77	2.87	.45	1.69	.17	1.13
3306 60 56	3/8	1/4	.51	.63	.53	.91	3.31	.57	2.05	.17	2.30

PART NO.	ØD1 MM	ØD2 MM	F MM	G1 MM	G2 MM	H MM	L MM	N MM	M MM	ØT MM	W KG
3306 06 04	6	4	11.5	13.5	11	18.5	72	11.5	43	4.2	.02
3306 08 04	8	4	11.5	13.5	11	18.5	73	11.5	43	4.2	.03
3306 08 06	8	6	11.5	13.5	11	18.5	73	11.5	43	4.2	.05
3306 10 06	10	6	13	16	13.5	23.0	84	14.5	52	4.2	.06
3306 10 08	10	8	13	16	13.5	23.5	84	14.5	52	4.2	.07

ØT = I.D. of mounting hole

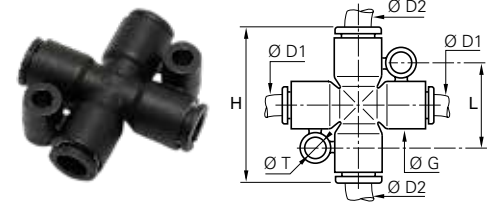

3107 Unequal Cross Metric

PART NO.	ØD1 MM	ØD2 MM	G MM	H MM	L MM	ØT MM	W KG
3107 04 06	4	6	11	36	20	4.2	.010
3107 06 08	6	8	13.5	46	22.5	4.2	.020
3107 06 04*	4	6	11	36	20	4.2	.010
3107 08 06*	6	8	13.5	46	22.5	4.2	.020

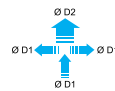

* This model provides three outlets ØD1 of equal diameters and one outlet ØD2 of a different diameter. (ØT = I.D. of mounting hole)

[Click here for CADs, Product Specifications or to Configure Parts Online](#)

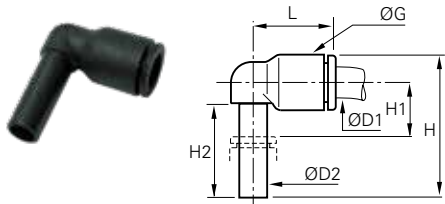

3182 Plug-In Elbow Fractional Inch

PART NO.	ØD1 IN	ØD2 IN	G IN	H IN	H1 IN	H2 IN	L IN	W OZ
3182 53 00	1/8	1/8	.33	.92	.31	.64	.57	.08
3182 04 00	5/32	5/32	.33	.91	.24	.61	.55	.11
3182 04 56	5/32	1/4	.43	1.08	.30	.71	.71	.20
3182 56 00	1/4	1/4	.43	1.20	.43	.83	.73	.11
3182 56 60	1/4	3/8	.63	1.52	.35	.96	.98	.14
3182 08 00	5/16	5/16	.53	1.32	.32	.85	.91	.14
3182 60 00	3/8	3/8	.63	1.52	.35	.96	1.02	.32
3182 62 00	1/2	1/2	.87	2.00	.51	1.12	1.38	.32

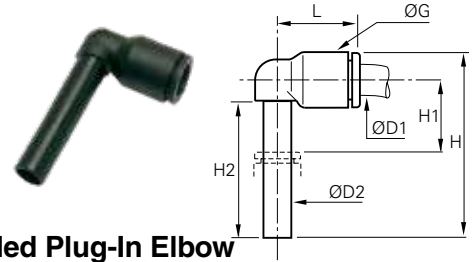

3184 Extended Plug-In Elbow

PART NO.	ØD1 IN	ØD2 IN	G IN	H IN	H1 IN	H2 IN	L IN	W OZ
3184 53 00	1/8	1/8	.33	1.26	.65	.98	.57	.18
3184 04 00	5/32	5/32	.33	1.28	.61	.98	.55	.18
3184 56 00	1/4	1/4	.43	1.56	.77	1.18	.71	.18
3184 08 00	5/16	5/16	.53	1.93	.93	1.46	.91	.21
3184 60 00	3/8	3/8	.63	2.19	1.02	1.63	1.02	.39

PART NO.	ØD1 MM	ØD2 MM	G MM	H MM	H1 MM	H2 MM	L MM	W KG
3184 04 00	4	4	8.5	32.5	15.5	25	14	.005
3184 06 00	6	6	10.5	38.5	19	29	16	.005
3184 08 00	8	8	13.5	49	23.5	37	23	.006
3184 10 00	10	10	16	56	26.5	41.5	26.5	.011
3184 12 00	12	12	19	62.5	28	45.5	31	.014

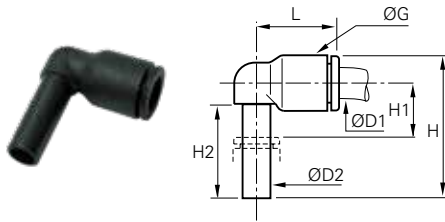

3182 Plug-In Elbow Metric

PART NO.	ØD1 MM	ØD2 MM	G MM	H MM	H1 MM	H2 MM	L MM	W OZ
3182 04 00	4	4	8.5	23	6	15.5	14	.003
3182 06 00	6	6	10.5	26.5	7	17	16	.003
3182 08 00	8	8	13.5	33.5	8	21.5	23	.004
3182 10 00	10	10	16	39	9.5	24.5	23.5	.009
3182 12 00	12	12	19	44.5	10	27.5	31	.012

PART NO.	ØD1 MM	ØD2 MM	G MM	H MM	H1 MM	H2 MM	L MM	W KG
3182 04 06	4	6	10.5	26.5	7	17	16	.003
3182 06 04	6	4	10.5	24.5	7	15.5	16	.003
3182 06 08	6	8	13.5	33.5	8	21.5	22	.004
3182 08 10	8	10	16	39	9.5	24.5	26.5	.009
3182 10 12	10	12	19	44.5	10	27.5	31	.012

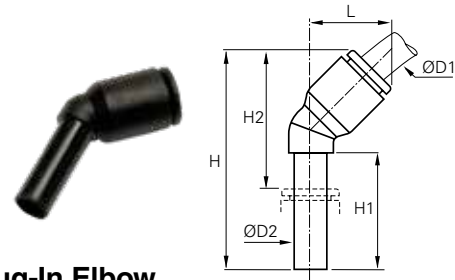

3180 - 45° Plug-In Elbow

PART NO.	ØD1 IN	ØD2 IN	H IN	H1 IN	H2 IN	L IN	W OZ
3180 53 00	1/8	1/8	1.14	.59	.69	.47	.18
3180 04 00	5/32	5/32	1.32	.75	.83	.51	.18
3180 56 00	1/4	1/4	1.44	.71	.87	.57	.18
3180 08 00	5/16	5/16	1.73	.85	1.00	.77	.21
3180 60 00	3/8	3/8	2.00	.96	1.16	.91	.32

PART NO.	ØD1 MM	ØD2 MM	H MM	H1 MM	H2 MM	L MM	W KG
3180 04 00	4	4	33.5	19	21	13	.005
3180 06 00	6	6	39	21	25	14.5	.005
3180 08 00	8	8	44	21.5	25.5	19.5	.006
3180 10 00	10	10	53	27	32.5	23	.009
3180 12 00	12	12	58.5	27.5	34	26.5	.012

[Click here for CADs, Product Specifications or to Configure Parts Online](#)

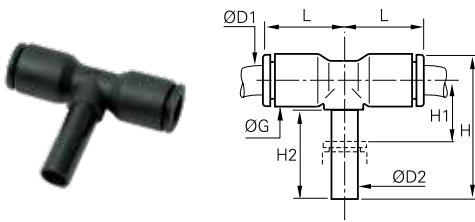

3188 Plug-In Tee Fractional Inch

PART NO.	ØD IN	G IN	H IN	H1 IN	H2 IN	L IN	W OZ
3188 53 00	1/8	.33	.95	.26	.59	.57	.083
3188 04 00	5/32	.33	.91	.24	.61	.57	.18
3188 56 00	1/4	.43	.98	.43	.77	.73	.18
3188 08 00	5/16	.53	1.32	.32	.85	.91	.28
3188 60 00	3/8	.63	1.61	.35	.96	.98	.423
3188 62 00	1/2	.87	2.01	.51	1.12	1.38	.600

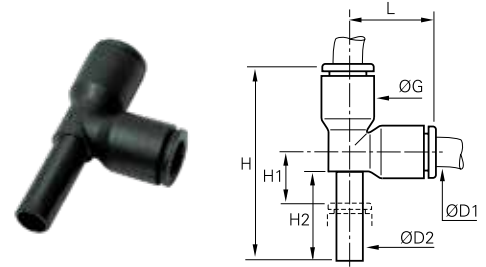

3183 Plug-In Run Tee Fractional Inch

PART NO.	ØD IN	G IN	H IN	H1 IN	H2 IN	L IN	W OZ
3183 04 00	5/32	.33	1.30	.24	.61	.57	.18
3183 56 00	1/4	.43	1.69	.43	.83	.73	.21
3183 08 00	5/16	.53	1.93	.32	.85	.91	.28
3183 60 00	3/8	.63	2.23	.33	.96	1.00	.423
3183 62 00	1/2	.87	2.86	.51	1.12	1.38	.600

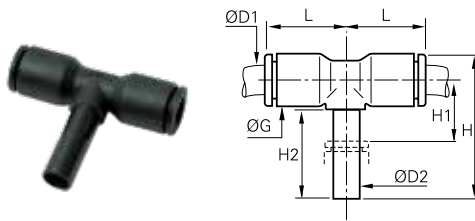

3188 Plug-In Tee Metric

PART NO.	ØD1 MM	ØD2 MM	G MM	H MM	H1 MM	H2 MM	L MM	W KG
3188 04 00	4	4	8.5	23	6	15.5	14.5	.005
3188 06 00	6	6	10.5	26.5	7	17	16	.006
3188 08 00	8	8	13.5	33.5	8	21.5	23	.008
3188 10 00	10	10	16	39	9.5	24.5	26.5	.012
3188 12 00	12	12	19	44.5	10	27.5	31	.017

PART NO.	ØD1 MM	ØD2 MM	G MM	H MM	H1 MM	H2 MM	L MM	W KG
3188 04 06	4	6	10.5	26.5	7	17	16	.006
3188 06 08	6	8	13.5	33.5	8	21.5	23	.007
3188 08 10	8	10	16	39	9.5	24.5	26.5	.011
3188 10 12	10	12	19	44.5	10	27.5	31	.016

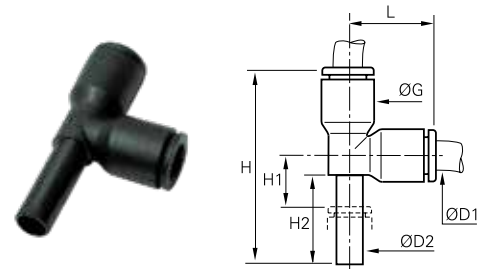

3183 Plug-In Run Tee Metric

PART NO.	ØD1 MM	ØD2 MM	G MM	H MM	H1 MM	H2 MM	L MM	W KG
3183 04 00	4	4	8.5	33	6	15.5	14.5	.005
3183 06 00	6	6	10.5	38.5	7	17	17.5	.006
3183 08 00	8	8	13.5	49	8	21.5	23	.008
3183 10 00	10	10	16	57	10.5	24.5	26.5	.012
3183 12 00	12	12	19	65.5	10.5	27.5	31	.017

PART NO.	ØD1 MM	ØD2 MM	G MM	H MM	H1 MM	H2 MM	L MM	W KG
3183 04 06	4	6	10.5	38.5	7	17	17.5	.006
3183 06 08	6	8	13.5	48.5	8	21.5	23	.007
3183 08 10	8	10	16	56.5	10.5	24.5	26.5	.011
3183 10 12	10	12	19	65.5	10.5	27.5	31	.016

[Click here for CADs, Product Specifications or to Configure Parts Online](#)

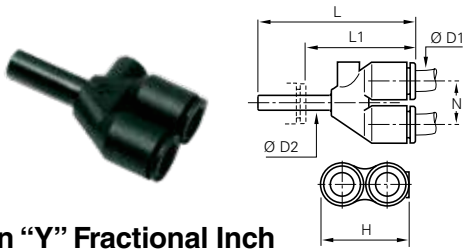

3142 Plug-In "Y" Fractional Inch

PART NO.	ØD1 IN	ØD2 IN	H IN	L IN	L1 IN	N IN	W OZ
3142 53 00	1/8	1/8	.69	1.36	1.00	.35	.13
3142 04 00	5/32	5/32	.69	1.34	.85	.35	.18
3142 56 00	1/4	1/4	.87	1.60	1.02	.45	.282
3142 08 00	5/16	5/16	1.10	2.00	1.26	.57	.49
3142 60 00	3/8	3/8	1.30	2.23	1.42	.67	.741

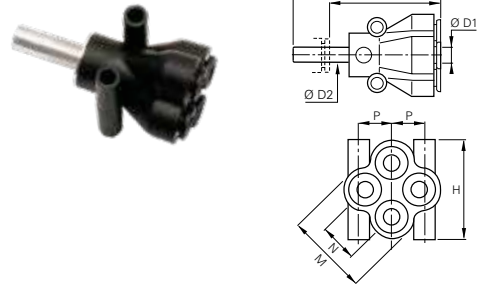

3143 Plug-In Multiple "Y" Metric

PART NO.	ØD1 IN	ØD2 IN	H MM	L MM	L1 MM	M MM	N MM	P MM	W KG
3143 04 06*	4	6	25.5	45	31	21	10	8.5	.027
3143 04 08*	4	8	25.5	49.5	31	21	10	8.5	.026
3143 06 08*	6	8	31.5	59.5	41	26.5	10	12	.040

* one inlet (ØD2) and four equal outlets (ØD1)

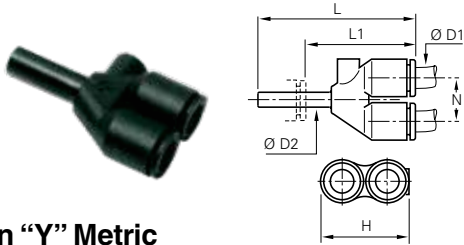

3142 Plug-In "Y" Metric

PART NO.	ØD1 IN	ØD2 IN	H MM	L MM	L1 MM	N MM	W KG
3142 04 00	4	4	17.5	34	21.5	9	.005
3142 06 00	6	6	21.5	39.5	25.5	11	.008
3142 08 00	8	8	28	50.5	32	14.5	.014
3142 10 00	10	10	33	57.5	36	17	.021
3142 12 00	12	12	39	66	41	20	.026

PART NO.	ØD1 IN	ØD2 IN	H MM	L MM	L1 MM	N MM	W KG
3142 04 06*	4	6	17.5	35.5	21.5	9	.005
3142 06 08*	6	8	22	44.5	26	11	.008
3142 08 10*	8	10	28	53.5	32	14.5	.014
3142 10 12*	10	12	33	60	35	17	.021

* one inlet (ØD2) and two equal outlets (ØD1)

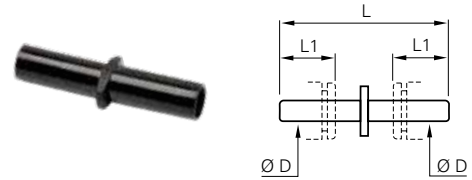

3120 Double Male Union Fractional Inch

PART NO.	ØD1 IN	L IN	L1 IN	W OZ
3120 04 00	5/32	1.36	.47	.04
3120 56 00	1/4	1.52	.57	.03
3120 08 00	5/16	1.61	.73	.07
3120 60 00	3/8	2.03	.81	.07

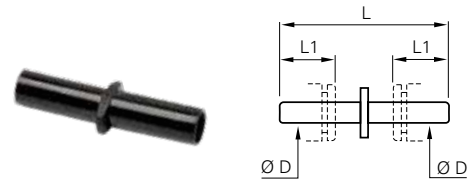

3120 Double Male Union Metric

PART NO.	ØD MM	L MM	L1 MM	W KG
3120 04 00	4	34.5	12	.001
3120 06 00	6	38.5	14	.001
3120 08 00	8	41	18.5	.002
3120 10 00	10	51.5	20.5	.003
3120 12 00	12	60	24.5	.004
3120 14 00	14	69.5	25.5	.005

[Click here for CADs, Product Specifications or to Configure Parts Online](#)

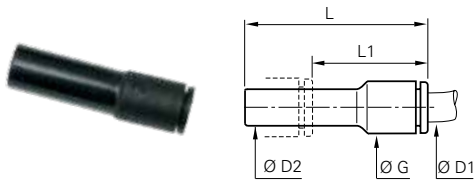

3166 Reducer Fractional Inch

PART NO.	ØD1 IN	ØD2 IN	G IN	L IN	L1 IN	W OZ
3166 53 04	1/8	5/32	.43	1.79	1.32	.28
3166 53 55	1/8	3/16	.43	1.79	1.14	.28
3166 53 56	1/8	1/4	.43	1.79	1.22	.29
3166 04 55	5/32	3/16	.34	1.48	.83	.11
3166 04 56	5/32	1/4	.34	1.48	.91	.09
3166 04 08	5/32	5/16	.34	1.48	.75	.14
3166 04 60	5/32	3/8	.43	1.61	.81	.35
3166 55 08	3/16	5/16	.43	1.79	1.06	.19
3166 55 56	3/16	1/4	.43	1.79	1.22	.22
3166 56 08	1/4	5/16	.43	1.61	.89	.12
3166 56 60	1/4	3/8	.43	1.61	.81	.13
3166 56 62	1/4	1/2	.63	1.97	.98	.30
3166 08 60	5/16	3/8	.53	1.93	1.12	.21
3166 08 62	5/16	1/2	.63	2.01	1.02	.29
3166 60 62	3/8	1/2	.63	2.01	1.04	.31

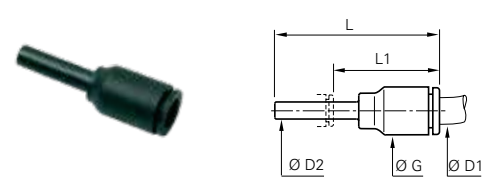

3168 Expander Fractional Inch

PART NO.	ØD1 IN	ØD2 IN	G IN	L IN	L1 IN	W OZ
3168 56 53	1/4	1/8	.43	1.61	1.16	.08
3168 56 06	1/4	6MM	.53	1.75	1.02	.11
3168 56 04	1/4	5/32	.43	1.61	1.14	.11
3168 56 55	1/4	3/16	.81	1.61	1.00	.12
3168 60 56	3/8	1/4	.63	1.58	1.00	.14

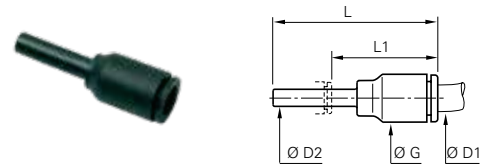

3168 Expander Metric

PART NO.	ØD1 MM	ØD2 MM	G MM	L MM	L1 MM	W KG
3168 06 04	6	4	10.5	35	23	.003
3168 08 06	8	6	13.5	45	31.5	.005
3168 10 08	10	8	16	42.5	21	.009
3168 12 10	12	10	19	49	24.5	.019

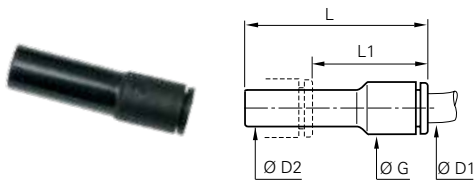

3166 Reducer Metric

PART NO.	ØD1 MM	ØD2 MM	G MM	L MM	L1 MM	W KG
3166 03 04	3	4	8.5	37.5	23.5	.004
3166 04 06	4	6	8.5	37.5	23.5	.004
3166 04 08	4	8	8.5	37.5	19	.004
3166 04 10	4	10	12	44	22.5	.005
3166 06 08	6	8	10.5	36	20.5	.004
3166 06 10	6	10	10.5	38	17.5	.006
3166 06 12	6	12	14.5	46	23	.007
3166 06 14	6	14	14.5	48	23	.008
3166 08 10	8	10	13.5	49	28.5	.009
3166 08 12	8	12	13.5	49	24.5	.010
3166 08 14	8	14	17	48	23	.010
3166 10 12	10	12	21.5	56.5	33.5	.019
3166 10 14	10	14	21.5	58.5	33.5	.020
3166 12 14	12	14	23.5	58.5	33.5	.023

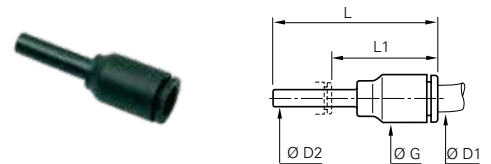

3168 Converter Metric to Fractional Inch

PART NO.	ØD1 MM	ØD2 IN	G IN	L IN	L1 IN	1 KG
3168 04 53	4	1/8	.43	1.61	1.16	.08
3168 08 56	8	1/4	.63	1.58	1.00	.12

[Click here for CADs, Product Specifications or to Configure Parts Online](#)

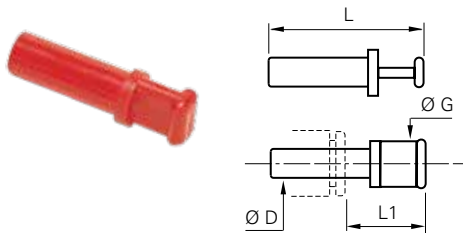

3126 Plug Fractional Inch

PART NO.	ØD IN	G IN	L IN	L1 IN	W OZ
3126 53 00	1/8	.24	1.30	.85	.05
3126 04 00	5/32	.16	1.18	.61	.04
3126 55 00	3/16	.27	1.36	.79	.06
3126 56 00	1/4	.32	1.44	.87	.06
3126 08 00	5/16	.39	1.38	.69	.07
3126 60 00	3/8	.46	1.67	.87	.10
3126 62 00	1/2	.58	1.91	.85	.18

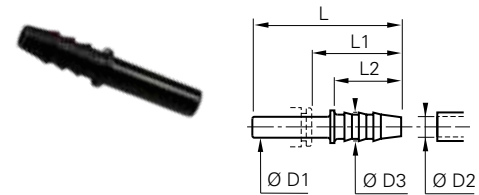

3122 Barbed Connector Fractional Inch

PART NO.	ØD1 MM	ØD2 MM	ØD3 MM	L IN	L1 IN	L2 IN	W OZ
3122 04 53	5/32	.12	.20	1.46	.98	.67	.11
3122 04 05	5/32	.20	.28	1.46	.98	.67	.11
3122 56 55*	1/4	3/16	.27	1.65	1.00	.67	.21
3122 08 56	5/16	.25	.34	1.55	.83	.67	.04
3122 08 08	5/16	.32	.39	1.75	1.02	.87	.04
3122 60 08	3/8	.32	.39	1.97	1.16	.87	.11

Dimensions for ØD2 are I.D. of the tube

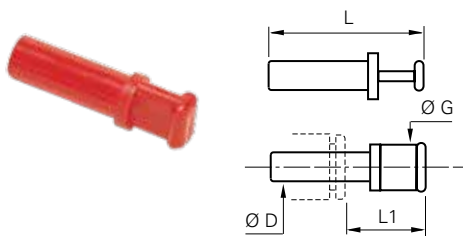

3126 Plug Metric

PART NO.	ØD MM	G MM	L MM	L1 MM	W KG
3126 03 00	3	6	25	13.5	.001
3126 04 00	4	4	30	15.5	.001
3126 06 00	6	8	33	16.5	.001
3126 08 00	8	10	33	17.5	.002
3126 10 00	10	12	42	21	.003
3126 12 00	12	14	45	22	.004
3126 14 00	14	16	49	23.5	.005
3126 16 00*	16	19	57	30	.006

*Nickel-plated brass

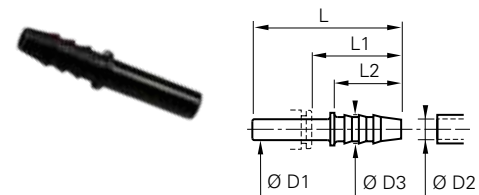

3122 Barbed Connector Metric

PART NO.	ØD1 MM	ØD2 MM	ØD3 MM	L MM	L1 MM	L2 MM	W KG
3122 04 53	4	3.2	5	37	25	17	.002
3122 04 05	4	5	7	37	25	17	.003
3122 06 05	6	5	7	39	25	17	.004
3122 08 56	8	6.3	8.5	39.5	21	17	.005
3122 08 08	8	8	10	44.5	26	22	.005
3122 10 56	10	6.3	8	45	24.5	17	.005
3122 10 08	10	8	10	50	29.5	22	.006
3122 12 08	12	8	10	50	26	22	.008
3122 12 10	12	10	12	48.5	25.5	22.5	.014
3122 12 62	12	12.5	14.5	57	34	22.5	.019
3122 14 62	14	12.5	14.5	59.5	34.5	22.5	.022

Dimensions for ØD2 are I.D. of the tube

Modular Plug-In Connectors



Parker Legris' modular plug-in connectors allow a maximum number of tube connections in a minimum of space. Offering an ergonomic solution to enable quick connection for the most complex installations.

Product Features:

- Silicone-Free

Panel-Mounted

- Panel mounted to a machine or bulkhead
- Reduced risk of incorrect assembly
- In-line connection
- Plated metal joiners and clips for reinforcement

In-Line

- Locating pin prevents incorrect assembly
- Cap guides the tubes and protects connections
- Aluminium and glass-reinforced nylon 6.6 components
- Bulkhead mountable

DIN Rail

- Used alongside electrical connectors
- Pressure indication
- Can be clipped side-by-side into a DIN rail profile [or Ω
- Channels or slots for labels for tube identification

Markets:

- Factory/Process Automation
- Automotive
- Packaging

Applications:

- Robotics
- Automotive Process
- Pneumatics
- Semi-Conductors
- Textile
- Packaging

Technical Characteristics:

Compatible Fluids	Compressed air Other fluids: please consult us
Working Pressure	145 psi (10 bar)
Vacuum Capability	28" Hg
Working Temperature	-4° to 176° F (-20° to +80° C)

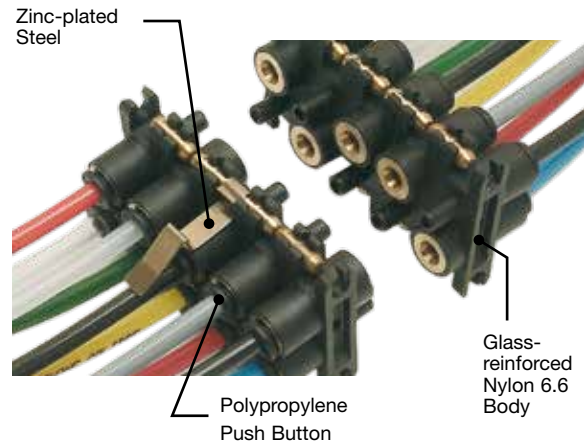

[Click here for CADs, Product Specifications or to Configure Parts Online](#)



These components are similar in principle to the electrical connectors found in control panels and used to rationalize cabling and trouble shooting.

Used alongside electrical connectors Legris DIN rail connectors provide similar facilities for pneumatic pipework, and are mounted on the same rail profile which allows electrics and pneumatics to run side by side. All tube connections are Legris push-to-connect fittings for plastic tubing.

Identification and Trouble Shooting

Tube identification

Channels or slots for labels are found on the front of these connectors which allows air lines to be coded and identified to assist in trouble shooting.

Test point facility

Being able to detect the presence of air is an important consideration when maintaining pneumatic control systems. Legris DIN rail connectors incorporate test points which pop out after being manually depressed, indicating the presence of air in the pipe.

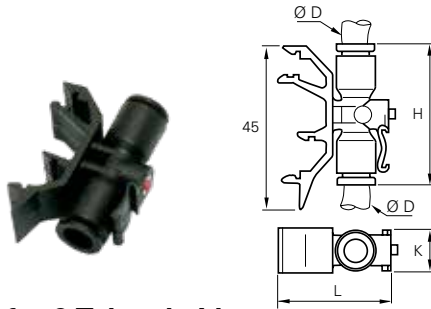
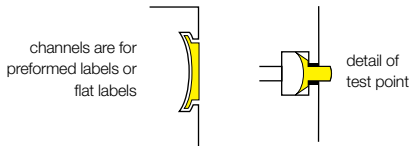

3379 Connector for 2 Tubes in Line

PART NO.	ØD IN	H IN	K IN	L IN	W OZ
3379 04 00	5/32	1.44	.47	1.18	.71
3379 56 00	1/4	1.44	.47	1.18	.92
3379 08 00	5/16	1.81	.51	1.28	1.20

PART NO.	ØD MM	H MM	G K MM	L MM	W KG
3379 04 00	4	36.5	12	30	.020
3379 06 00	6	36.5	12	30	.026
3379 08 00	8	46	13	32.5	.034

fixed by clipping to DIN rail

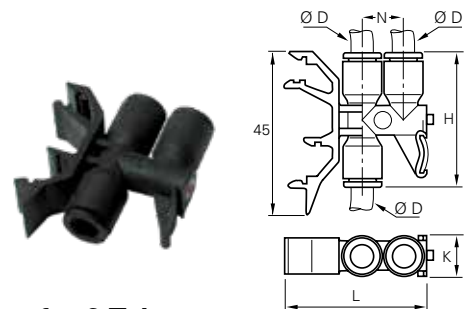

3381 Connector for 3 Tubes

PART NO.	ØD IN	H IN	K IN	L IN	N IN	W OZ
3381 04 00	5/32	1.44	.43	1.56	.45	.95
3381 08 00	5/16	1.81	.51	1.75	.57	1.52

PART NO.	ØD MM	H MM	K MM	L MM	N MM	W KG
3381 04 00	4	36.5	11	39.5	11.5	.027
3381 06 00	6	36.5	11	39.5	11.5	.033
3381 08 00	8	46	13	44.5	14.5	.043

fixed by clipping to DIN rail

Click here for CADs, Product Specifications or to Configure Parts Online



The modular construction of this component allows a number of pneumatic tubes to be connected or separated with a simple plug-in action.

A series of male/female connectors provide a leak proof joint. Units of any length can be constructed.

The two common uses for this product are:

1. Fixing one half to a panel, machine or bulkhead and allowing the floating half to be assembled or disconnected to change a machine or sequence. Often when machines are transported air lines are separated and this connection provides a foolproof method of reconnection on site.
2. Using the connector in an in-line mode for joining long lengths of pipe-work which need to be disconnected periodically. It is advisable to limit the unit length to five connectors as illustrated in the photograph below.

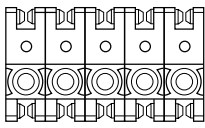

standard assembly

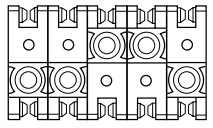

offset assembly

Personalization of Connector

By reversing the slices of the module during their assembly it is possible to "offset" units so that they cannot be mixed or inadvertently connected in the wrong order.

Components Used in the Module Assembly

The module is constructed from a number of symmetrical components that are designed to work together.

When fully assembled, one box of the modular plug-in connector provides twenty, 4mm tube connections (ten in one half and ten mating ones in the other).

The complete box contains:

- 10 units each
- 20 joining pins and 4 end pins
- 4 mounting brackets
- 4 coupling clips
- 1 dismantling tool

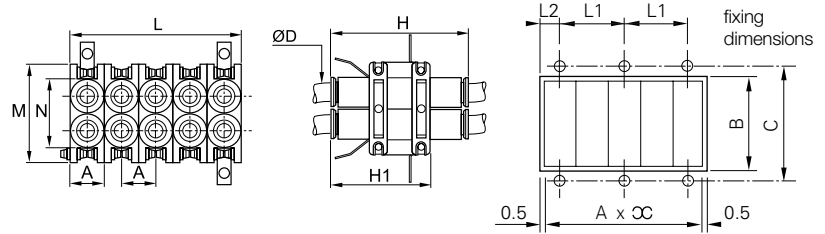
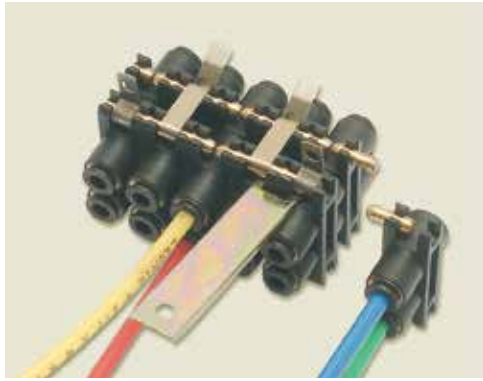

3300 Modular Plug-In Connectors

PART NO.	ØD	A MM	B MM	C MM	H MM	H1 MM	L MM	L1 MM	L2 MM	M MM	N MM	W KG
3300 04 00	5/32, 4MM	11	21	40	40.5	29.5	55	22	6	32	20	0.106
3300 06 00	6MM	14	28	47	48	38.5	70	28	7.5	39	27.5	0.106
3300 08 00	5/16, 8MM	14	28	47	50	39	70	28	7.5	39	27.5	0.106

[Click here for CADs, Product Specifications or to Configure Parts Online](#)



The Parker Legris multi-tube connector is designed for simultaneous connection and disconnection of seven and 12 tubes. Its LF3000 technology and performance makes it easy to use:

- Instant connection and disconnection, without tools
- Full flow, without restriction

In order to facilitate the installation, each tube outlet is numbered. A location pin avoids assembly errors and a cap helps to guide the tubes and to protect connections. To cover all users' needs, this range can also be used for bulkhead connections.



3320 Male Connector Body Fractional Inch

PART NO.	ØD IN	NUMBER OF OUTLETS	C1	C2	ØD 1 IN	W OZ
3320 53 00 07	1/8	7	M46X1.5	M40X1.5	1.97	2.48
3320 04 00 07	5/32	7	M46X1.5	M40X1.5	1.97	2.50
3320 04 00 12	5/32	12	M65X1.5	M58X1.5	2.76	4.83
3320 56 00 07	1/4	7	M65X1.5	M58X1.5	2.76	4.72
3320 56 00 12	1/4	12	M72X1.5	M65X1.5	2.95	5.10

The number of male body outlets must correspond to the same number of outlets on the female body. E.g. Model 3320 04 00 07 must only be connected to model 3321 04 00 07.

3321 Female Connector Body Fractional Inch

PART NO.	ØD IN	NUMBER OF OUTLETS	C1	C2	ØD 1 IN	W OZ
3321 53 00 07	1/8	7	M46X1.5	M40X1.5	2.17	2.24
3321 04 00 07	5/32	7	M46X1.5	M40X1.5	2.17	2.56
3321 04 00 12	5/32	12	M65X1.5	M58X1.5	2.95	4.34
3321 56 00 07	1/4	7	M65X1.5	M58X1.5	2.95	4.48
3321 56 00 12	1/4	12	M72X1.5	M65X1.5	2.95	4.96
3321 60 00 07	3/8	7	M65X1.5	M58X1.5	2.95	4.56

The number of female body outlets must correspond to the same number of outlets on the male body. E.g. Model 3320 04 00 07 must only be connected to model 3321 04 00 07.

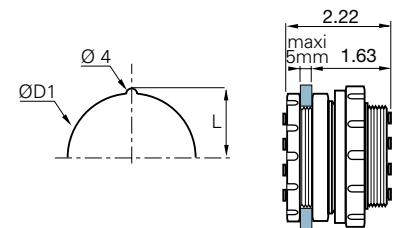
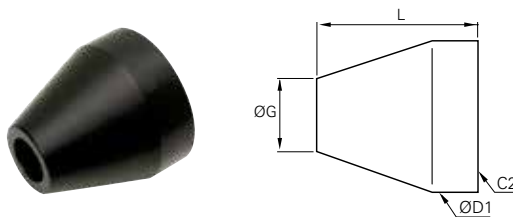

3329 Cap

PART NO.	ØD IN	NUMBER OF OUTLETS	C2	G IN	L IN	ØD 1 IN
3329 00 02	1/8	7	M40X1.5	1.38	2.17	1.97
3329 00 03	1/8	12	M58X1.5	1.65	2.76	2.76
3329 00 02	5/32	7	M40X1.5	1.38	2.17	1.97
3329 00 03	5/32	12	M58X1.5	1.65	2.76	2.76
3329 00 03	1/4	7	M58X1.5	1.65	2.76	1.97
3329 00 04	1/4	12	M65X1.5	2.01	3.46	2.95
3329 00 03	3/8	7	M58X1.5	1.65	2.76	2.76

Overall Dimensions For Bulkhead Mounting Fra

PART NO.	ØD IN	NUMBER OF OUTLETS	C1	C2	ØD 1 IN	W OZ
3321 53 00 07	1/8	7	M46X1.5	M40X1.5	2.17	2.24
3321 04 00 07	5/32	7	M46X1.5	M40X1.5	2.17	2.56
3321 04 00 12	5/32	12	M65X1.5	M58X1.5	2.95	4.34
3321 56 00 07	1/4	7	M65X1.5	M58X1.5	2.95	4.48
3321 56 00 12	1/4	12	M72X1.5	M65X1.5	2.95	4.96
3321 60 00 07	3/8	7	M65X1.5	M58X1.5	2.95	4.56

Self-Sealing and Oscillating Fittings



Parker Legris has developed these innovative push-to-connect fittings in order to integrate various functions and allow quick installation on pneumatic circuits.

Product Features:

- Silicone-Free

Self-Sealing Fittings

- Prevents fluid flow when there is no tube connected
- Circuits may remain pressurized when being checked and maintained
- When connected, the compressed air flow is restored in both directions

Oscillating Fittings

- Rotation matched to cylinder rod stroke
- Prevents tube wear due to excessive flexing
- Optimum reliability and durability
- Simplifies circuit assembly

Markets:

- Automotive
- Textile
- Packaging
- Semi-Conductor

Applications:

- Robotics
- Automotive Process
- Pneumatics
- Semi-Conductors
- Textile
- Packaging

Specifications:

Compatible Fluids	Compressed air Other fluids: please consult us
Working Pressure	290 psi (20 bar) 145 psi (10 bar) self sealing fittings
Vacuum Capability	28" Hg
Working Temperature	-4° to 176° F (-20° to +80° C)

Reliable performance is dependent upon the type of fluid conveyed, component materials and tubing being used. Use is guaranteed with a vacuum of 755 mm Hg (99% vacuum).

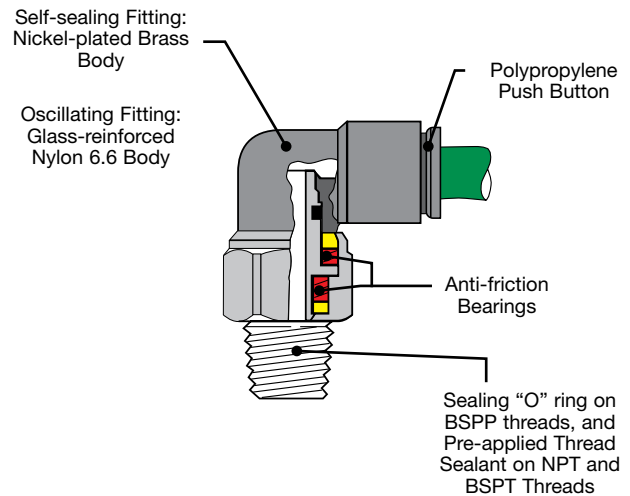

Installation Configurations

Self-Sealing Fittings

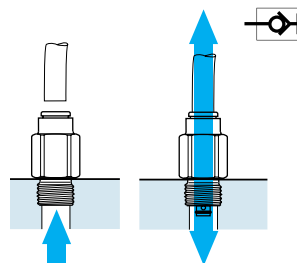

Oscillating Fittings

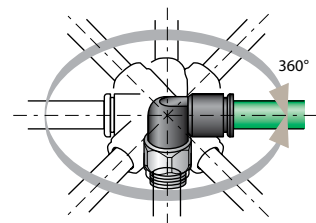

[Click here for CADs, Product Specifications or to Configure Parts Online](#)

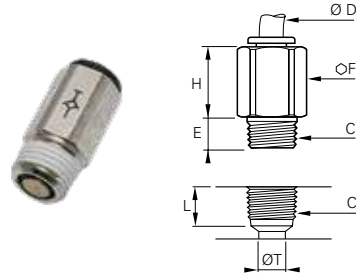

3091 Self-Sealing Male Fitting NPT or BSPT

PART NO.	ØD IN	C NPT	E IN	F MM	H IN	L IN	ØT IN
3091 04 11	5/32	1/8	.30	12	.51	.37	.20
3091 56 11	1/4	1/8	.30	13	.60	.37	.30
3091 56 14	1/4	1/4	.43	14	.41	.55	.30
3091 60 14	3/8	1/4	.43	19	.83	.55	.35
3091 60 18	3/8	3/8	.45	19	.73	.55	.40

PART NO.	ØD MM	C BSPT	E MM	F MM	H MM	L MM	ØT MM
3091 04 10	4	R1/8	7.5	12	18	9.5	5
3091 06 10	6	R1/8	7.5	13	19.5	9.5	7.5
3091 08 10	8	R1/8	6.5	14	25	10.5	7.5
3091 08 13	8	R1/4	11	14	25.5	13.5	9

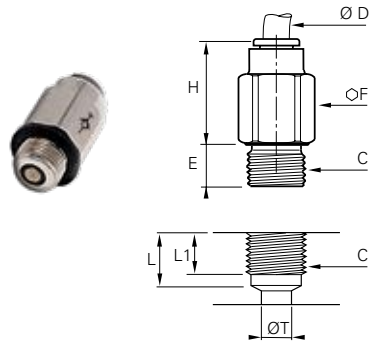

3391 Self-Sealing Male Fitting Metric Tube to BSPP

PART NO.	ØD MM	C BSPP	E MM	F MM	H MM
3391 04 10	4	G1/8	5	13	18
3391 06 10	6	G1/8	5	14	19.5
3391 08 10	8	G1/8	5	14	29.5
3391 08 13	8	G1/4	5.5	16	25.5
3391 10 17	10	G3/8	5.5	20	27.5

Stud Dimensions

ØD MM	C BSPP	E MM	F MM	H MM
4	G1/8	7.5	6	5
6	G1/8	9	6	7.5
8	G1/8	10	6	7.5
8	G1/4	11	8	9
10	G 3/8	13	11	10

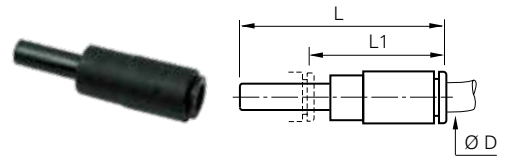

3160 Self-Sealing Plug-in Fitting Metric

PART NO.	ØD MM	L MM	L1 MM
3160 04 00	4	46	33.5
3160 06 00	6	53.5	31
3160 08 00	8	58	31

This model prevents fluid flow in-line when there is no tube connected; connecting the tube allows fluid flow.

WARNING These products can expose you to chemicals including LEAD which is known to the state of California to cause cancer.

[Click here for CADs, Product Specifications or to Configure Parts Online](#)

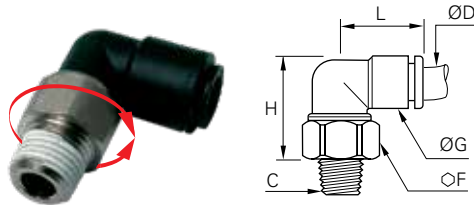

3159 Oscillating Male Elbow Fractional Inch Tube to NPT

PART NO.	ØD IN	C NPT	F MM	G IN	H IN	L IN
3159 04 11	5/32	1/8	12	.43	.85	.69
3159 56 11	1/4	1/8	14	.55	1.04	.81
3159 56 14	1/4	1/4	14	.55	1.04	.81

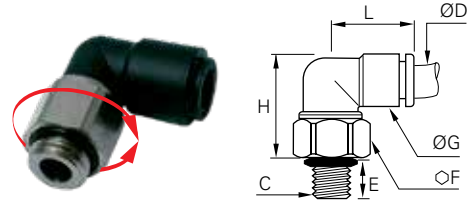

3189 Oscillating Male Elbow Metric Tube to BSPP or M5

PART NO.	ØD MM	C BSPP/M5	E MM	F MM	G MM	H MM	L MM
3189 04 19	4	M5X0.8	3	12	11	24.5	17.5
3189 04 10	4	G1/8	5	13	11	23	17.5
3189 06 19	6	M5X0.8	3	12	14	27.5	20.5
3189 06 10	6	G1/8	5	14	14	27	20.5
3189 06 13	6	G1/4	5.5	16	14	25.5	20.5
3189 08 10	8	G1/8	5	17	16	33.5	23.5
3189 08 13	8	G1/4	5.5	17	16	31	23.5
3189 08 17	8	G3/8	5.5	20	16	29.5	23.5
3189 10 13	10	G1/4	5.5	19	19.5	50	29
3189 10 17	10	G3/8	5.5	20	19.5	37	29
3189 12 13	12	G1/4	5.5	21	22	46.5	33.5
3189 12 17	12	G3/8	5.5	21	22	45.5	33.5

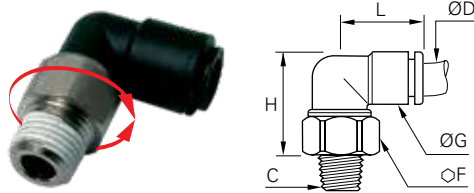

3159 Oscillating Male Elbow Metric Tube to BSPT

PART NO.	ØD MM	C BSPT	H IN	L IN	L1 IN	N IN
3159 04 10	4	R1/8	12	11	22	17.5
3159 06 10	6	R1/8	14	14	26.5	20.5
3159 06 13	6	R1/4	14	14	23.5	20.5
3159 08 10	8	R1/8	17	16	32	23.5
3159 08 13	8	R1/4	17	16	29	23.5
3159 08 17	8	R3/8	17	16	25	23.5
3159 10 13	10	R1/4	19	19.5	37.5	29
3159 10 17	10	R3/8	19	19.5	33.5	29
3159 12 13	12	R1/4	21	22	44.5	33.5
3159 12 17	12	R3/8	21	22	41	33.5

Torque/Rotation Speed

ØD MM	C BSPP/M5	PART NO.
5/32, 4	<2.5.10 ⁻³	190
1/4, 6	<4.10 ⁻³	160
8	<7.10 ⁻³	120
10	<11.10 ⁻³	90
12	<16.10 ⁻³	80

WARNING These products can expose you to chemicals including NICKEL or LEAD, which are known to the state of California to cause cancer.

[Click here for CADs, Product Specifications or to Configure Parts Online](#)

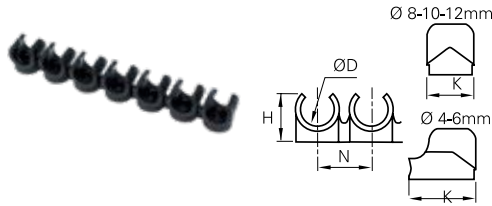

CLIP Clip Strips for Tubing and Fittings

PART NO.	ØD TUBE	Ø LF3000 TO BE CLIPPED	H MM	K MM	N MM	NUMBER OF CLIPS PER STRIP
CLIP 04 00	5/32, 4MM		9	13.5	10.5	8
CLIP 06 00	1/4, 3/16, 6MM		10.5	13	10.5	8
CLIP 08 00	5/16, 8MM	5/32, 4MM	12.5	10.5	12	7
CLIP 10 00	3/8, 10MM	1/4, 6MM	14	12	15	6
CLIP 12 00	1/2, 12MM		16.5	14	16.5	5
CLIP 14 00	14MM	5/16, 8MM	18	16	20.5	4

Clip strips come complete with screws of .375 inches in length.

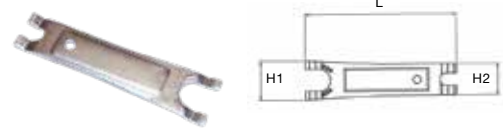

3000 70 Disconnection Tool

PART NO.	H1 MM	H2 MM	L MM
3000 70 00	25	20	96

In cases where access is difficult this tool can be useful, particularly if the standard release buttons have been removed. (Release buttons can only be removed on 3/16 sizes.)

AQRT - Quick Release Tool

Makes disconnection of tube adapters and tubing a breeze.



7000 Joining Clips for In-Line Flow Controls and Mini Ball Valves*

PART NO.	ØD IN	ØD MM
7000 00 05	5/32	4
7000 00 05	1/4	6
7000 00 05	5/16	8
7000 00 06	3/8	10
7000 00 06	1/2	12

*Two clips are supplied with flow control. Order additional clips using the part numbers above.

3151 End Caps

PART NO. FRACTIONAL INCH	ØD IN	ØG IN	H IN
3151 53 00	1/8	.33	.55
3151 04 00	5/32	.33	.55
3151 56 00	1/4	.41	.64
3151 08 00	5/16	.53	.86
3151 60 00	3/8	.53	.88

PART NO. METRIC	ØD MM	ØG MM	H MM
3151 04 00	4	8.5	14.7
3151 06 00	6	10.5	16.9
3151 08 00	8	13.5	21.9
3151 10 00	10	16	22.2
3151 12 00	12	19	27.7

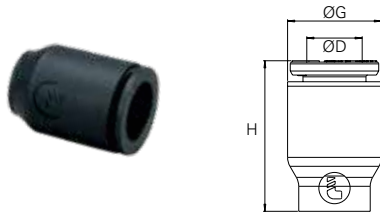

3000 71 00 Tube Cutter

PART NO.	H IN	L IN
3000 71 00	.98	3.11







This tool will cut all resilient plastic tube (e.g. nylon, polyurethane, braided PVC, soft rubber, etc.) from 1/8 to 1/2 and 3mm to 16mm diameter inclusive. It is designed to give a clean cut at right angles to the tube axis. A spring maintains the cutter in the closed position.







WARNING These products can expose you to chemicals including LEAD which is known to the state of California to cause cancer.

[Click here for CADs, Product Specifications or to Configure Parts Online](#)



3110/3330 Caps/Manual Release Button

ØD TUBE IN						
1/8	3110 53 00	-	3110 53 02	3110 53 03	3110 53 04	3110 53 05
5/32	3110 04 00	3330 04 01	3110 04 02	3110 04 03	3110 04 04	3110 04 05
3/16	3330 55 00	3330 55 01	3330 55 02	3330 55 03	3330 55 04	3330 55 05
1/4	3110 56 00	3330 56 01	3110 56 02	3110 56 03	3110 56 04	3110 56 05
5/16	3110 08 00	-	3110 08 02	3110 08 03	3110 08 04	3110 08 05
3/8	3110 60 00	3330 60 01	-	-	3110 60 04	3110 60 05
1/2	3110 62 00	3330 62 01	3110 62 02	3110 62 03	3110 62 04	3110 62 05

ØD TUBE MM						
4	3110 04 00	3330 04 01	3110 04 02	3110 04 03	3110 04 04	3110 04 05
6	3110 06 00	-	3110 06 02	3110 06 03	3110 06 04	3110 06 05
8	3110 08 00	-	3110 08 02	3110 08 03	3110 08 04	3110 08 05
10	3110 10 00	-	3110 10 02	3110 10 03	3110 10 04	3110 10 05
12	3110 12 00	-	3110 12 02	3110 12 03	3110 12 04	3110 12 05
14	3110 14 00	-	3110 14 02	3110 14 03	3110 14 04	-

In all sizes of the LF3000 fittings, except 3/16, the push button is an integral part of the design which makes it non-removable, and comes standard in black. For identification of the circuits, colored caps (p/n 3110) fit over the black push button.

WARNING These products can expose you to chemicals including LEAD which is known to the state of California to cause cancer.



LF3600 Metal Push-to-Connect Fittings

To meet your technical and environment requirements, Parker Legris' LF3600 fittings offers the robustness, reliability and resistance to industrial fluids for the most demanding environments.

Product Features:

- High phosphorous, FDA-compliant, chemical resistant, nickel-plated collet and body
- FKM seal
- Chemical, corrosion, and abrasion resistance
- NPT, BSPT, BSPP, and metric threads
- Silicone-Free

Markets:

- Industrial
- Chemical
- Life Science
- Automation
- Food Processing

Applications:

- Food Fluids
- Harsh Detergents
- Cleaning In Cold/ Hot Water
- Steam
- Oils

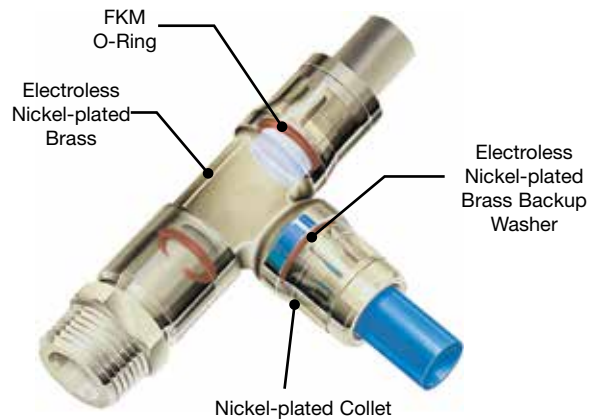

Specifications:

Pressure Range	Up to 435 psi (30 bar)
Temperature Range	-13° to 302° F (-25° to 150° C)
Vacuum Capability	28" Hg

Note: Maximum working pressure and temperature are dependent on the type of tubing used

Note: Units with thread sealant do not meet FDA Compliance.

Compatible Tubing:

- Polyethylene
- Polyurethane 95 Durometer Shore A
- Semi-Rigid Nylon
- Fluoropolymer
- Stainless Steel (when grooved)
- Copper (when grooved)



■ Threaded Fittings

3675

Male Connector
Taper
p. A55



3601

Male Connector
UNF, Parallel
and Metric
p. A55



3681

Male Connector
Metric
p. A56



3014/3615

Female Connector
Taper
p. A56



3614

Female Connector
Parallel and Metric
p. A56



3609

Male Elbow
Taper
p. A56



3699

Male Elbow
Parallel and Metric
p. A57



3629

Extended Male
Elbow – Taper
p. A57



3669

Extended Male
Elbow – Parallel
and Metric
p. A57



3608

Male Branch Tee
Taper
p. A58



3698

Male Branch Tee
UNF, Parallel
and Metric
p. A58



3693

Male Run Tee
UNF, Parallel
and Metric
p. A58



3603

Male Run Tee
Taper
p. A59



3621

Male Standpipe
Taper
p. A59



3631

Male Standpipe
Parallel and Metric
p. A59



■ Tube to Tube Fittings

3606

Union
p. A60



3602

Union Elbow
p. A60



3604

Union Tee
p. A61



■ Banjo Body

3618

Banjo
Parallel and Metric
p. A60



■ Bulkhead Connectors

3616

Bulkhead Union
p. A61



3636

Female Bulkhead
p. A61



3639

Equal Bulkhead
Elbow
p. A61



■ Accessories

3666

Reducer
p. A62



3668

Expander
p. A62



3667

Expander
p. A62



3122

Barbed Connector
p. A62



3622

Plug-In Barbed
Connector
p. A62



3120

Double Male Union
p. A63



3620

Double Male Union
p. A63



3126

Plug
p. A63



3626

Plug
p. A63



[Click here for CADs, Product Specifications or to Configure Parts Online](#)

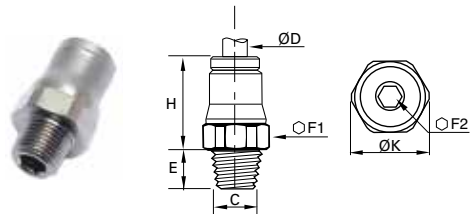

3675 Male Connector Fractional Inch Tube to NPT

PART NO.	ØD IN	C NPT	E IN	F1 MM	F2 MM	H IN	K IN
3675 04 11*	5/32	1/8	.30	11	3	.59	.47
3675 04 14*	5/32	1/4	.43	14	3	.59	.59
3675 56 11*	1/4	1/8	.30	13	4	.67	.55
3675 56 14*	1/4	1/4	.43	14	4	.67	.59
3675 56 18*	1/4	3/8	.45	18	5	.67	.77
3675 60 11*	3/8	1/8	.30	18	4	.97	.77
3675 60 14*	3/8	1/4	.43	18	7	.95	.77
3675 60 18*	3/8	3/8	.45	18	8	.91	.77
3675 60 22*	3/8	1/2	.59	22	8	.95	.94
3675 62 18*	1/2	3/8	.45	22	9	.95	.94
3675 62 22*	1/2	1/2	.59	22	10	.95	.94

*For thread sealant, add 96 suffix to part number. Example: 3675 56 14 96
 Note: units with thread sealant do not meet FDA Compliance.

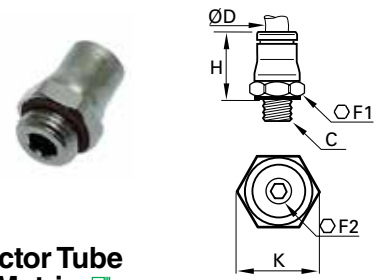

3601 Male Connector Tube to UNF, BSPP or Metric

PART NO. FRACTIONAL INCH	ØD IN	C UNF/BSPP	F1 MM	F2 MM	H IN	K IN
3601 04 20	5/32	10-32	10	2.5	.61	.43
3601 56 20	1/4	10-32	13	2.5	.75	.55
3601 56 10	1/4	G1/8	13	5	.768	.55

PART NO. METRIC	ØD MM	C BSPP/METRIC	F1 MM	F2 MM	H MM	K MM
3601 04 19	4	M5X0.8	10	2.5	15.5	11
3601 04 10	4	G1/8	13	3	14.5	14
3601 04 52	4	M6X1	10	3	16	11
3601 04 13	4	G1/4	16	3	14.5	17.5
3601 04 56	4	M8X1	11	3	14.5	12
3601 06 19	6	M5X0.8	13	2.5	19	14
3601 06 10	6	G1/8	13	4	17.5	14
3601 06 60	6	M10X1	13	4	17.5	14
3601 06 13	6	G1/4	16	4	17	17.5
3601 08 10	8	G1/8	16	5	21	16
3601 08 13	8	G1/4	16	6	18	17.5
3601 08 17	8	G3/8	20	6	19	22
3601 10 13	10	G1/4	18	7	25	19.5
3601 10 17	10	G3/8	20	8	22.5	22
3601 10 21	10	G1/2	24	8	22.5	26
3601 12 13	12	G1/4	20	7	27	22
3601 12 17	12	G3/8	20	9	26	22
3601 12 21	12	G1/2	24	10	23.5	26
3601 14 17	14	G3/8	22	9	28	24
3601 14 21	14	G1/2	24	11	26.5	26

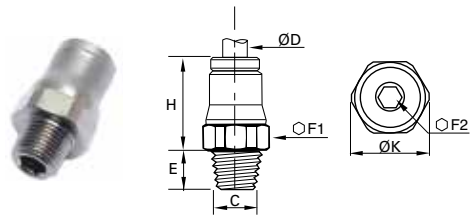

3675 Male Connector Metric Tube to BSPT

PART NO.	ØD MM	C BSPP/M5	F1 MM	F2 MM	H MM	K MM
3675 04 10	4	R1/8	10	3	15	11
3675 04 13	4	R1/4	14	3	15	15
3675 06 10	6	R1/8	13	4	17	14
3675 06 13	6	R1/4	14	4	17	15
3675 08 10	8	R1/8	15	5	19	16
3675 08 13	8	R1/4	15	6	18	16
3675 08 17	8	R3/8	17	6	18.5	18.5
3675 10 13	10	R1/4	18	7	23	19.5
3675 10 17	10	R3/8	18	8	22.5	19.5
3675 10 21	10	R1/2	22	8	22.5	24
3675 12 13	12	R1/4	20	7	25.5	22
3675 12 17	12	R3/8	20	9	24	22
3675 12 21	12	R1/2	22	10	23	24
3675 14 17	14	R3/8	22	9	27	24
3675 14 21	14	R1/2	24	11	26	26

= suitable for food applications

WARNING These products can expose you to chemicals including NICKEL or LEAD, which are known to the state of California to cause cancer.

Click here for CADs, Product Specifications or to Configure Parts Online

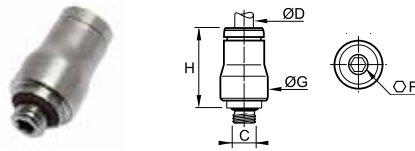

3681 Male Connector Metric Tube to M5

PART NO.	ØD MM	C M5	F MM	G MM	H IN
3681 04 19	4	M5X0.8	2.5	10	16

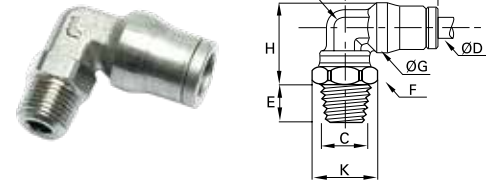

3609 Male Elbow Fractional Inch Tube to NPT

PART NO.	ØD IN	C NPT	E IN	F MM	G IN	H IN	J IN	K IN	L IN
3609 53 11**†	1/8	1/8	.30	13	.34	.57	.28	.55	.59
3609 04 11*	5/32	1/8	.30	11	.39	.59	.28	.47	.71
3609 04 14*	5/32	1/4	.43	14	.39	.67	.28	.60	.71
3609 56 11*	1/4	1/8	.30	11	.49	.69	.32	.47	.87
3609 56 14*	1/4	1/4	.43	14	.49	.75	.32	.60	.87
3609 56 18*	1/4	3/8	.45	18	.49	.75	.32	.77	.87
3609 60 14*	3/8	1/4	.43	15	.67	.93	.47	.63	1.14
3609 60 18*	3/8	3/8	.45	18	.67	1.02	.47	.77	1.14
3609 60 22*	3/8	1/2	.59	22	.67	1.06	.47	.94	1.14
3609 62 18*	1/2	3/8	.45	18	.79	1.14	.59	.77	1.22
3609 62 22*	1/2	1/2	.59	22	.79	1.14	.59	.94	1.22

*For thread sealant, add 96 suffix to part number. Example: 3609 56 14 96
†plastic button, metal body; does not meet FDA Compliance

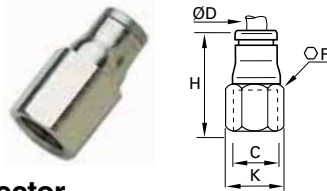

3014/3615 Female Connector Fractional Inch Tube to NPT

PART NO.	ØD IN	C NPT	E IN	F MM	H IN	K IN
3615 60 14	3/8	1/4	.55	17	1.50	.73
3615 60 18	3/8	3/8	.55	22	1.50	.94
3615 62 18	1/2	3/8	.55	22	1.52	.94
3615 62 22	1/2	1/2	.73	24	1.67	1.02

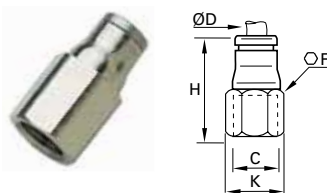

3614 Female Connector Metric Tube to BSPP or M5

PART NO.	ØD MM	C BSPP/M5	F MM	H MM	K MM
3614 04 19	4	M5X0.8	10	22	11
3614 04 10	4	G1/8	14	25	15
3614 04 13	4	G1/4	17	29	18.5
3614 06 10	6	G1/8	14	27.5	15
3614 06 13	6	G1/4	17	31.5	18.5
3614 08 10	8	G1/8	15	28.5	16
3614 08 13	8	G1/4	17	32.5	18.5
3614 10 17	10	G3/8	22	38	24
3614 12 17	12	G3/8	22	39	24
3614 12 21	12	G1/2	24	43.5	26

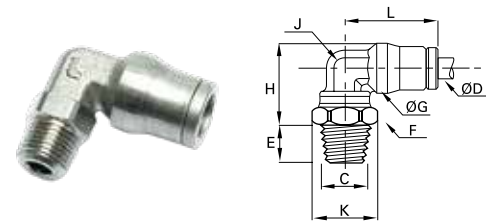

3609 Male Elbow Metric Tube to BSPT

PART NO.	ØD MM	C BSPT	F MM	G MM	H MM	K MM	L MM
3609 04 10	4	R1/8	11	10	15	12	18
3609 04 13	4	R1/4	14	10	17	15	18
3609 06 10	6	R1/8	11	12	17.5	12	21.5
3609 06 13	6	R1/4	14	12	19	15	21.5
3609 08 10	8	R1/8	11	15	19.5	12	23.5
3609 08 13	8	R1/4	14	15	21	15	23.5
3609 08 17	8	R3/8	17	15	21	18.5	23.5
3609 10 13	10	R1/4	15	17.5	23.5	16	29
3609 10 17	10	R3/8	17	17.5	25.5	18.5	29
3609 12 13	12	R1/4	15	19.5	26	16	31
3609 12 17	12	R3/8	17	19.5	28.5	18.5	31
3609 12 21	12	R1/2	21	19.5	28.5	23	31
3609 14 17	14	R3/8	19	21.5	29	21	34
3609 14 21	14	R1/2	24	21.5	30	26	34

= suitable for food applications

WARNING These products can expose you to chemicals including NICKEL or LEAD, which are known to the state of California to cause cancer.

[Click here for CADs, Product Specifications or to Configure Parts Online](#)

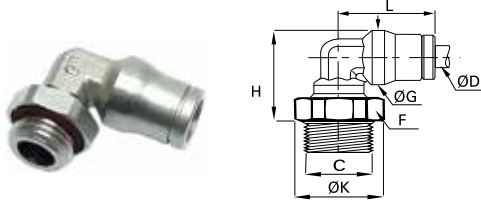

3699 Male Elbow Tube to UNF, BSPP or Metric

PART NO. FRACTIONAL INCH	ØD IN	C UNF/BSPP	F MM	G IN	H IN	K IN	L IN
3699 04 20	5/32	10-32	10	.39	.71	.43	.71
3699 56 10	1/4	G1/8	13	12	19	14	21.5
3699 56 13	1/4	G1/4	16	12	19.5	17.5	21.5

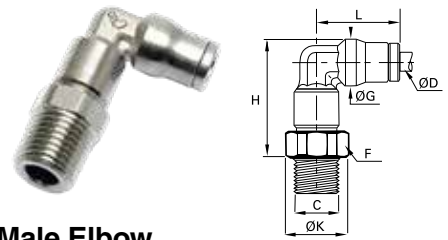

3629 Extended Male Elbow Metric Tube to BSPT

PART NO.	ØD MM	C BSPT	F MM	G MM	H MM	K MM	L MM
3629 04 10	4	R1/8	10	10	24.5	11	18
3629 06 10	6	R1/8	13	12	29.5	14	21.5
3629 06 13	6	R1/4	14	12	30.5	15	21.5
3629 08 10	8	R1/8	14	15	32.5	15	23.5
3629 08 13	8	R1/4	14	15	34	15	23.5
3629 10 13	10	R1/4	18	17.5	39	19.5	29

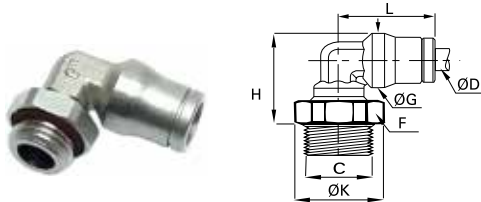

3699 Male Elbow Tube to UNF, BSPP or Metric

PART NO. METRIC	ØD IN	C BSPP/METRIC	F MM	G MM	H MM	K MM	L MM
3699 04 19	4	M5X0.8	10	10	18	11	18
3699 04 10	4	G1/8	13	10	17	14	18
3699 04 52	4	M6X1	10	10	18	11	18
3699 04 13	4	G1/4	16	10	17.5	17.5	18
3699 04 56	4	M8X1	11	10	18	12	18
3699 06 19	6	M5X0.8	10	12	20	14	22
3699 06 10	6	G1/8	13	12	19	14	21.5
3699 06 60	6	M10X1	13	12	19	14	21.5
3699 06 13	6	G1/4	16	12	19.5	17.5	21.5
3699 08 10	8	G1/8	13	15	20.5	14	23.5
3699 08 13	8	G1/4	16	15	21.5	17.5	23.5
3699 08 17	8	G3/8	20	15	21.5	22	23.5
3699 10 13	10	G1/4	16	17.5	27	17.5	29
3699 10 17	10	G3/8	20	17.5	25.5	22	29
3699 12 13	12	G1/4	16	19.5	29.5	17.5	31
3699 12 17	12	G3/8	20	19.5	28.5	22	31
3699 12 21	12	G1/2	24	19.5	28.5	26	31
3699 14 17	14	G3/8	20	21.5	29	22	34
3699 14 21	14	G1/2	24	21.5	29.5	26	34

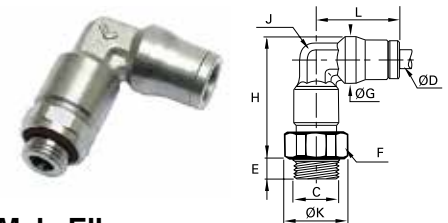

3669 Extended Male Elbow Metric Tube to BSPP or M5

PART NO.	ØD MM	C BSPP/M5	F MM	G MM	H MM	K MM	L MM
3669 04 19	4	M5X0.8	10	10	27.5	11	18
3669 04 10	4	G1/8	13	10	25.5	14	18
3669 06 10	6	G1/8	13	12	31	14	18
3669 06 13	6	G1/4	16	12	30.5	17.5	21.5
3669 08 10	8	G1/8	14	15	33.5	15	23.5
3669 08 13	8	G1/4	16	15	34	17.5	23.5
3669 10 13	10	G1/4	18	17.5	42	19.5	29
3669 10 17	10	G3/8	20	17.5	41	22	29
3669 12 13	12	G1/4	20	19.5	47	22	31
3669 12 17	12	G3/8	20	19.5	46	22	31
3669 14 21	14	G1/2	24	21.5	49	26	34

= suitable for food applications

WARNING These products can expose you to chemicals including NICKEL or LEAD, which are known to the state of California to cause cancer.

[Click here for CADs, Product Specifications or to Configure Parts Online](#)

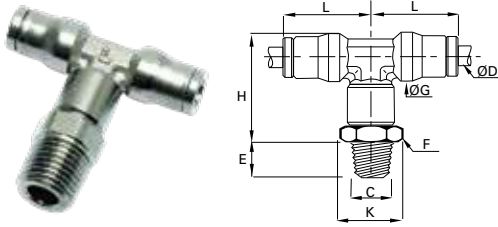

3608 Male Branch Tee
Fractional Inch Tube to Tube to NPT

PART NO.	ØD IN	C NPT	E IN	F MM	G IN	H IN	K IN	L IN
3608 53 11*†	1/8	1/8	.30	11	.34	.85	.47	.59
3608 60 14*	3/8	1/4	.43	18	.67	1.54	.77	1.14
3608 60 22*	3/8	1/2	.59	22	.67	1.61	.94	1.14
3608 62 22*	1/2	1/2	.59	22	.79	1.89	.94	1.22

*For thread sealant, add 96 suffix to part number. Example: 3608 56 14 96
 †plastic button, metal body; does not meet FDA Compliance

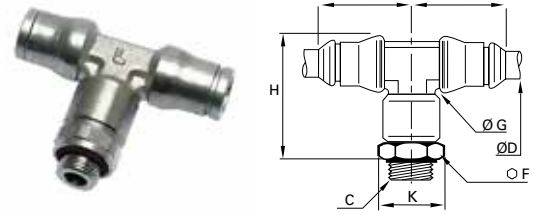

3698 Male Branch Tee Tube to Tube
to UNF, BSPP or M5

PART NO. FRACTIONAL INCH	ØD IN	C UNF	F MM	G IN	H IN	K IN	L IN
3698 04 20	5/32	10-32	10	.39	1.00	.47	.71

PART NO. METRIC	ØD MM	C BSPP/M5	F MM	G MM	H MM	K MM	L MM
3698 04 19	4	M5X0.8	10	10	27.5	11	18
3698 04 10	4	G1/8	13	10	25.5	14	18
3698 06 10	6	G1/8	13	12	31	14	21.5
3698 06 13	6	G1/4	16	12	30.5	17.5	21.5
3698 08 10	8	G1/8	14	15	33.5	15	23.5
3698 08 13	8	G1/4	16	15	34	17.5	23.5
3698 10 13	10	G1/4	18	17.5	42	19.5	29
3698 12 17	12	G3/8	21	19.5	46	23	31
3698 14 21	14	G1/2	24	21.5	49	26	34

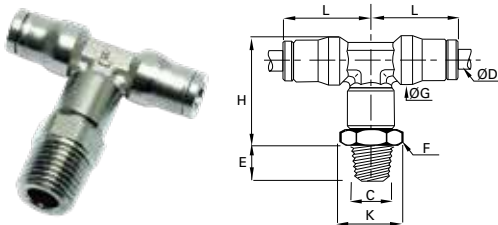

3608 Male Branch Tee
Metric Tube to Tube to BSPT

PART NO.	ØD MM	C BSPT	F MM	G MM	H MM	K MM	L MM
3608 04 10	4	R1/8	10	10	24.5	11	18
3608 06 10	6	R1/8	13	12	29.5	14	21.5
3608 06 13	6	R1/4	14	12	30.5	15	21.5
3608 08 10	8	R1/8	14	15	32.5	15	23.5
3608 08 13	8	R1/4	14	15	34	15	23.5
3608 10 13	10	R1/4	18	17.5	39	19.5	29
3608 10 17	10	R3/8	18	17.5	41	19.5	29
3608 12 17	12	R3/8	21	19.5	46.5	23	31
3608 14 21	14	R1/2	22	21.5	50.5	24	34

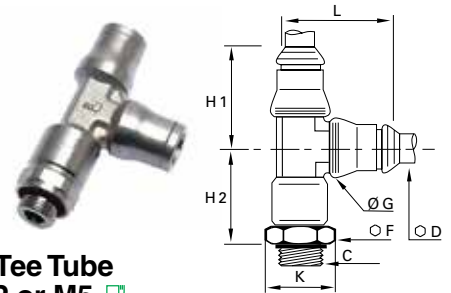

3693 Male Run Tee Tube
to Tube to BSPP or M5

PART NO. METRIC	ØD MM	C BSPP/M5	F MM	G MM	H1 MM	H2 MM	K MM	L MM
3693 04 19	4	M5X0.8	10	10	18	22.5	11	23
3693 04 10	4	G1/8	13	10	18	20.5	14	23
3693 06 10	6	G1/8	13	12	21.5	25	14	28
3693 06 13	6	G1/4	16	12	21.5	24.5	17.5	28
3693 08 10	8	G1/8	14	15	23.5	26.5	15	31
3693 08 13	8	G1/4	16	15	23.5	26.5	17.5	31
3693 10 13	10	G1/4	18	17.5	29	33	19.5	37.5
3693 12 17	12	G3/8	21	19.5	31	36.5	23	40.5
3693 14 21	14	G1/2	24	21.5	34	38.5	26	45

= suitable for food applications

WARNING These products can expose you to chemicals including NICKEL or LEAD, which are known to the state of California to cause cancer.

[Click here for CADs, Product Specifications or to Configure Parts Online](#)

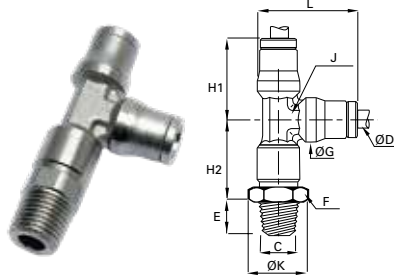

3603 Male Run Tee
Fractional Inch Tube to Tube to NPT

PART NO.	ØD IN	C NPT	E IN	F MM	G IN	H1 IN	H2 IN	J IN	K IN	L IN
3603 04 11	5/32	1/8	.30	11	.39	.71	.77	.28	.47	.91
3603 60 14*	3/8	1/4	.43	18	.67	1.14	1.20	.47	.77	1.48
3603 60 18*	3/8	3/8	.45	18	.67	1.14	1.28	.47	.77	1.48
3603 56 11	1/4	1/4		14		.87	.97		.59	1.12
3603 60 22	3/8	1/2		22		1.14	1.28		.94	1.48
3603 62 18	1/2	3/8		22		1.22	1.46		.94	1.61

*For thread sealant, add 96 suffix to part number. Example: 3603 56 14 96
 †plastic button, metal body; does not meet FDA Compliance

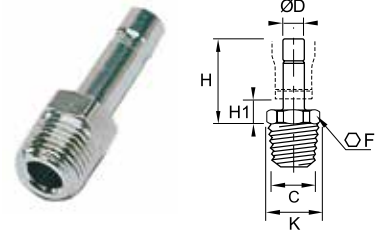

3621 Male Stud Standpipe Metric
Tube to BSPT

PART NO.	ØD MM	C BSPT	F1 MM	H MM	H1 MM	K MM
3621 04 10	4	R1/8	10	21	7	11
3621 04 13	4	R1/4	14	21	7	15
3621 06 10	6	R1/8	10	23.5	6.5	11
3621 06 13	6	R1/4	10	23.5	6.5	15
3621 08 10	8	R1/8	10	24	6.5	11
3621 08 13	8	R1/4	14	24	6.5	15
3621 10 13	10	R1/4	14	22	6.5	15
3621 10 17	10	R3/8	17	30	7.5	18.5
3621 12 17	12	R3/8	17	31	7.5	18.5
3621 12 21	12	R1/2	22	38	7.5	24
3621 14 21	14	R1/2	22	33	8	24

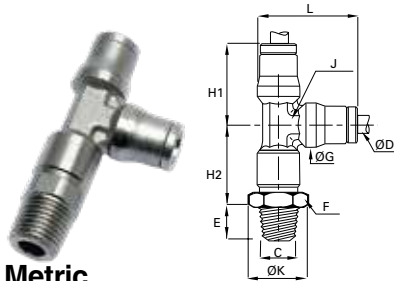

3603 Male Run Tee Metric
Tube to Tube to BSPT

PART NO.	ØD MM	C BSPT	F MM	G MM	H1 MM	H2 MM	K MM	L MM
3603 04 10	4	R1/8	10	10	18	19.5	11	23
3603 06 10	6	R1/8	13	12	21.5	23.5	14	28
3603 06 13	6	R1/4	14	12	21.5	24.5	15	28
3603 08 10	8	R1/8	14	15	23.5	25	15	31
3603 08 13	8	R1/4	14	15	23.5	26.5	15	31
3603 10 13	10	R1/4	18	17.5	29	30.5	19.5	37.5
3603 10 17	10	R3/8	18	17.5	29	32.5	19.5	37.5
3603 12 17	12	R3/8	21	19.5	31	36.5	23	40.5
3603 14 21	14	R1/2	22	21.5	34	40	24	45

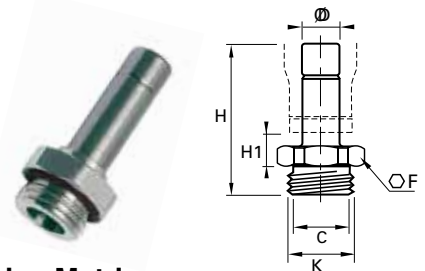

3631 Male Standpipe Metric
Tube to BSPP or M5

PART NO.	ØD MM	C BSPP/M5	F1 MM	H MM	H1 MM	K MM
3631 04 19	4	M5X0.8	13	25.5	7	14
3631 04 10	4	G1/8	16	26.5	7	17.5
3631 04 13	4	G1/4	8	25	7.5	8.7
3631 06 10	6	G1/8	13	28	6.5	14
3631 06 13	6	G1/4	16	29	6.5	17.5
3631 08 10	8	G1/8	13	28.5	6.5	14
3631 08 13	8	G1/4	16	29.5	6.5	17.5
3631 08 17	8	G3/8	20	30.5	7.5	22
3631 10 13	10	G1/4	16	34.5	6.5	17.5
3631 10 17	10	G3/8	20	35.5	7.5	22
3631 10 21	10	G1/2	24	37	7.5	26
3631 12 17	12	G3/8	20	36.5	7.5	22
3631 12 21	12	G1/2	24	38	7.5	26
3631 14 21	14	G1/2	24	40	8	26

= suitable for food applications

WARNING These products can expose you to chemicals including NICKEL or LEAD, which are known to the state of California to cause cancer.

[Click here for CADs, Product Specifications or to Configure Parts Online](#)

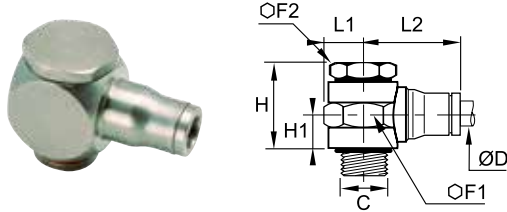

3618 Single Banjo Metric Tube to BSPP or M5

PART NO.	ØD MM	C BSPP/M5	F1 MM	F2 MM	H MM	H1 MM	L1 MM	L2 MM
3618 04 19	4	M5X0.8	10	8	14.5	6.5	6	18.5
3618 04 10	4	G1/8	17	14	23	9.5	10	20.5
3618 06 19	6	M5X0.8	10	8	15	7	6	22.5
3618 06 10	6	G1/8	17	14	23	9.5	10	23.5
3618 06 13	6	G1/4	22	17	22	9	13	25.5
3618 08 10	8	G1/8	17	14	23	9.5	10	26
3618 08 13	8	G1/4	22	17	22	9	13	27.5
3618 10 17	10	G3/8	22	22	33	14	13	32

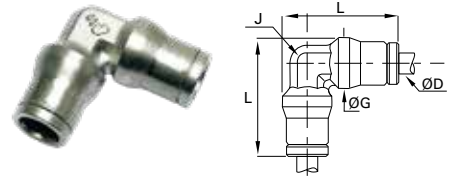

3602 Union Elbow Fractional Inch Tube to Tube

PART NO.	ØD IN	G IN	J IN	L IN
3602 53 00†	1/8	.34	.28	.91
3602 04 00	5/32	.39	.28	.91
3602 56 00	1/4	.49	.32	1.12
3602 08 00	5/16	.59	.39	1.22
3602 60 00	3/8	.67	.47	1.48
3602 62 00	1/2	.79	.59	1.61

†plastic button, metal body; does not meet FDA Compliance

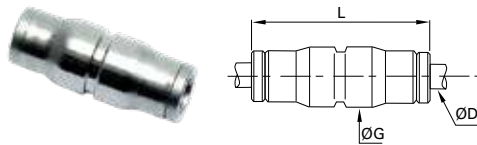

3606 Straight Union Fractional Inch Tube to Tube

PART NO.	ØD IN	G IN	L IN
3606 53 00†	1/8	.34	.97
3606 04 00	5/32	.39	1.20
3606 56 00	1/4	.49	1.44
3606 08 00	5/16	.59	1.48
3606 60 00	3/8	.67	1.87
3606 62 00	1/2	.79	1.89

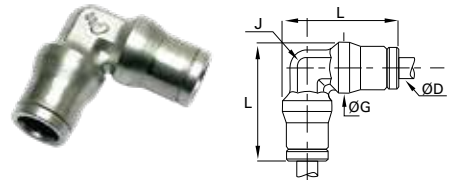

3602 Union Elbow Metric Tube to Tube

PART NO.	ØD MM	G MM	L MM
3602 04 00	4	10	23
3602 06 00	6	12	28
3602 08 00	8	15	31
3602 10 00	10	17.5	37.5
3602 12 00	12	19.5	40.5
3602 14 00	14	21.5	45

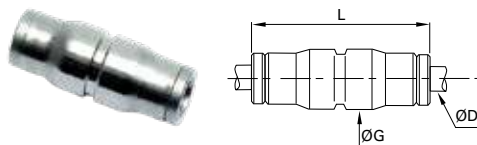

3606 Straight Union Metric Tube to Tube

PART NO.	ØD MM	G MM	L MM
3606 04 00	4	10	30.5
3606 06 00	6	12	36.5
3606 08 00	8	15	37.5
3606 10 00	10	17.5	47.5
3606 12 00	12	19.5	50
3606 14 00	14	21.5	52.5

= suitable for food applications

WARNING These products can expose you to chemicals including NICKEL or LEAD, which are known to the state of California to cause cancer.

[Click here for CADs, Product Specifications or to Configure Parts Online](#)

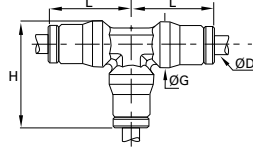

3604 Union Tee Fractional Inch Tube to Tube to Tube

PART NO.	ØD IN	G IN	H IN	L IN
3604 04 00	5/32	.39	.91	.71
3604 56 00	1/4	.49	1.12	.87
3604 08 00	5/16	.59	1.22	.93
3604 60 00	3/8	.67	1.48	1.14
3604 62 00	1/2	.79	1.61	1.22

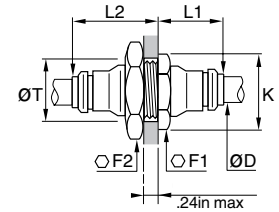

3616 Bulkhead Connector Fractional Inch Tube to Tube

PART NO.	ØD IN	F1 MM	F2 MM	K IN	L1 IN	L2 IN	T IN
3616 04 00	5/32	13	14	.55	.55	.79	.49
3616 56 00	1/4	16	17	.69	.67	.89	.59
3616 08 00	5/16	18	19	.77	.73	.93	.67
3616 60 00	3/8	22	27	.95	.87	1.10	.85
3616 62 00	1/2	24	24	1.16	.89	1.14	1.04

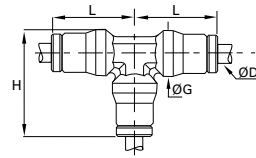

3604 Union Tee Metric Tube to Tube to Tube

PART NO.	ØD MM	G MM	H MM	L MM
3604 04 00	4	10	23	18
3604 06 00	6	12	28	21.5
3604 08 00	8	15	31	23.5
3604 10 00	10	17.5	37.5	29
3604 12 00	12	19.5	40.5	31
3604 14 00	14	21.5	45	34

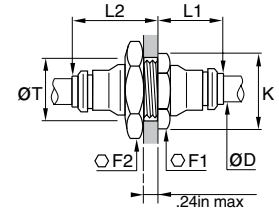

3616 Bulkhead Connector Metric Tube to Tube

PART NO.	ØD MM	F1 MM	F2 MM	K MM	L1 MM	L2 MM	T MM
3616 04 00	4	13	14	14	14	20	12.5
3616 06 00	6	16	17	17.5	17	22	15
3616 08 00	8	18	19	19.5	18.5	23.5	17
3616 10 00	10	22	27	24	21.5	26.5	21
3616 12 00	12	24	24	26	23	27	23
3616 14 00	14	27	27	29.5	25.5	29.5	25

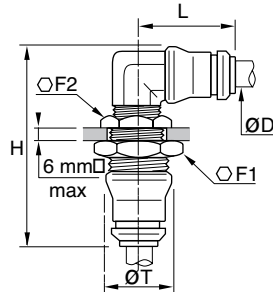

3639 Bulkhead Elbow Metric Tube to Tube

PART NO.	ØD MM	F1 MM	F2 MM	H MM	K MM	L MM	T MM
3639 04 00	4	13	14	35	14	18	12.5
3639 06 00	6	16	17	40.5	17.5	21.5	15
3639 08 00	8	18	19	44	19.5	23.5	17
3639 10 00	10	22	27	51	24	29	21
3639 12 00	12	24	24	55	26	31	23
3639 14 00	14	27	27	59	29.5	34	25

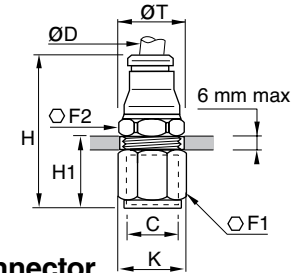

3636 Female Bulkhead Connector Metric Tube to BSPP

PART NO.	ØD1 MM	C BSPP	F1 MM	F2 MM	H MM	H1 MM	K MM	T MM
3636 04 10	4	G1/8	14	14	30.5	11	15	13
3636 06 10	6	G1/8	17	17	32.5	11	18.5	15
3636 06 13	6	G1/4	17	17	37	15	18.5	15
3636 08 10	8	G1/8	19	19	34	10.5	21	17
3636 08 13	8	G1/4	19	19	38	14.5	21	17
3636 10 17	10	G3/8	22	27	42.5	16	24	21
3636 12 17	12	G3/8	24	24	43	16	26	23
3636 12 21	12	G1/2	27	24	48.5	21.5	29.5	23

= suitable for food applications

WARNING These products can expose you to chemicals including NICKEL or LEAD, which are known to the state of California to cause cancer.

[Click here for CADs, Product Specifications or to Configure Parts Online](#)

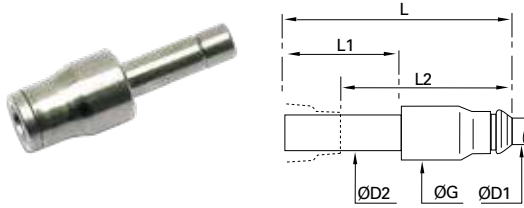

3666 Plug-In Reducer Fractional Inch

PART NO.	ØD1 IN	ØD2 IN	G MM	L MM	L1 MM	L2 MM
3666 04 56	5/32	1/4	.39	1.36	.75	.69
3666 04 08	5/32	5/16	.39	1.40	.79	.71
3666 56 60	1/4	3/8	.49	1.46	.79	.77
3666 56 62	1/4	1/2	.49	1.71	.98	.83
3666 60 62	3/8	1/2	.67	1.97	1.02	1.04

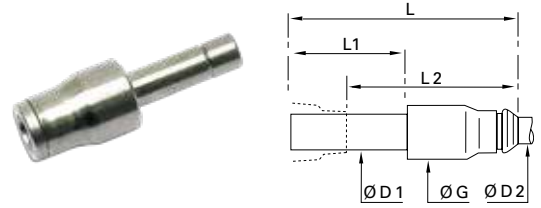

3667 Plug-In Adapter Metric/Inch

PART NO.	ØD1 MM	ØD2 IN	G MM	L MM	L1 MM	L2 MM
3667 06 56	6	1/4	12.5	38	19	20.5
3667 10 60	10	3/8	17	49.5	25	27
3667 12 62	12	1/2	20	51	26	27.5

This item allows fractional inch tube to be used with fittings designed for use with metric tubing.

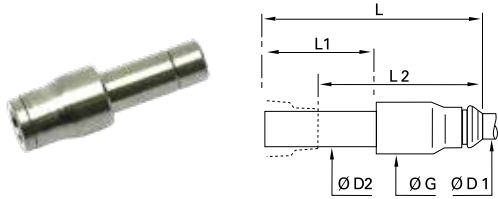

3666 Plug-In Reducer Metric

PART NO.	ØD1 MM	ØD2 MM	G MM	L MM	L1 MM	L2 MM
3666 04 06	4	6	10	34.5	19	17.5
3666 04 08	4	8	10	35.5	20	18
3666 06 08	6	8	12	37	20	19.5
3666 06 10	6	10	12	43.5	25	21
3666 08 10	8	10	15	44	25	21.5
3666 08 12	8	12	15	45	26	21.5
3666 10 12	10	12	17.5	50	26	26.5
3666 12 14	12	14	19.5	53	28	28.5

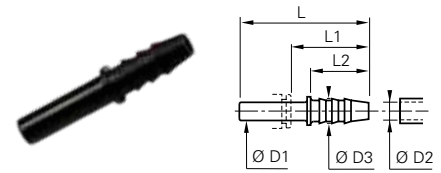

3122 Barbed Connector Fractional Inch

PART NO.	ØD1 IN	ØD2 MM	ØD3 MM	L IN	L1 IN	L2 IN
3122 04 53	5/32	.12	.20	1.46	.98	.67
3122 04 05	5/32	.20	.28	1.46	.98	.67
3122 08 56	5/16	.25	.34	1.55	.83	.67
3122 08 08	5/16	.32	.39	1.75	1.02	.87
3122 60 08	3/8	.32	.39	1.97	1.16	.87

Dimensions for ØD2 are I.D. of the tube. 3122 does not meet FDA compliance

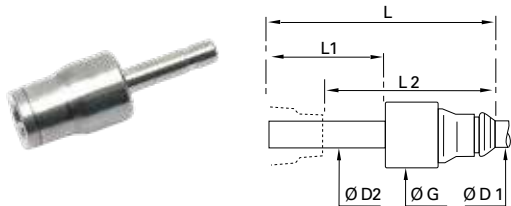

3668 Plug-In Expander Metric

PART NO.	ØD1 MM	ØD2 MM	G MM	L MM	L1 MM	L2 MM
3668 06 04	6	4	17	42	22	28

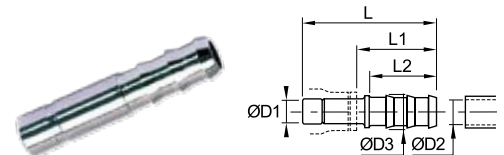

3622 Plug-In Barbed Connector Metric

PART NO.	ØD1 MM	ØD2 MM	ØD3 MM	L MM	L1 MM	L2 MM
3622 04 53	4	3.2	5	40.5	27	22.5
3622 04 05	4	5	7	40.5	27	22.5
3622 06 05	6	5	7	43	27	22.5
3622 08 56	8	6.3	8.3	42	25	22.5
3622 08 08	8	8	10	44	27	22.5
3622 10 56	10	6.3	10	47.5	25.5	22.5
3622 10 08	10	8	8.3	47.5	25.5	22.5
3622 12 08	12	8	10	48.5	25.5	22.5
3622 12 10	12	10	12	48.5	25.5	22.5
3622 12 62	12	12.5	14.5	57	34	29.5
3622 14 62	14	12.5	14.5	57.5	33	29.5
3622 14 14	14	14	16	59.5	35	29.5

= suitable for food applications

WARNING These products can expose you to chemicals including NICKEL or LEAD, which are known to the state of California to cause cancer.

[Click here for CADs, Product Specifications or to Configure Parts Online](#)

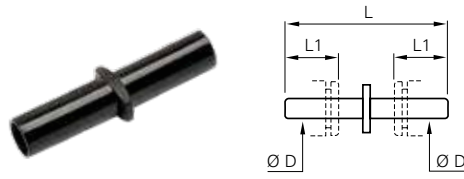

3120 Double Male Union Fractional Inch

PART NO.	ØD MM	L MM	L1 MM
3120 04 00	5/32	1.36	.47
3120 55 00 85*	3/16	1.24	.57
3120 56 00	1/4	1.52	.57
3120 08 00	5/16	1.61	.73
3120 60 00	3/8	2.03	.81
3120 62 00 85*	1/2	2.13	.86

3120 does not meet FDA compliance

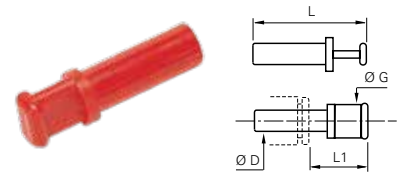

3126 Plug Fractional Inch

PART NO.	ØD IN	G IN	L IN	L1 IN
3126 53 00	1/8	.24	1.30	.85
3126 04 00	5/32	.16	1.18	.61
3126 55 00	3/16	.27	1.36	.79
3126 56 00	1/4	.32	1.44	.87
3126 08 00	5/16	.39	1.38	.69
3126 60 00	3/8	.46	1.67	.87
3126 62 00	1/2	.58	1.91	.85

3126 does not meet FDA compliance

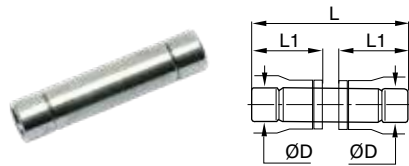

3620 Double Male Union Metric

PART NO.	ØD MM	L MM	L1 MM
3620 04 00	4	31	14
3620 06 00	6	36.5	17
3620 08 00	8	37.5	17.5
3620 10 00	10	47.5	22.5
3620 12 00	12	49.5	23.5
3620 14 00	14	53	25

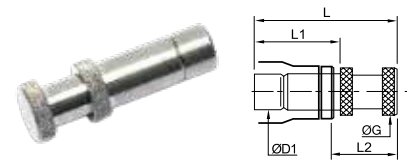

3626 Plug Metric

PART NO.	ØD1 MM	ØG MM	L MM	L1 MM	L2 MM
3626 04 00	4	6	25.5	17	11.5
3626 06 00	6	8	30.5	19.5	13.5
3626 08 00	8	10	33	20	16
3626 10 00	10	12	40	25	18
3626 12 00	12	14	43	26	20
3626 14 00	14	16	47	28	22.5

= suitable for food applications

WARNING These products can expose you to chemicals including NICKEL or LEAD, which are known to the state of California to cause cancer.



LF3800 Stainless Steel Push-to-Connect Fittings

Parker Legris' LF3800 fittings are ideal for conveying corrosive fluids in aggressive environments. LF3800 fittings provide corrosion resistance and a hygienic external design.

Product Features:

- Silicone-Free
- Stainless steel 316L collet
- Stainless steel 316L body
- FKM seal
- Stainless steel 316L backup washer
- Chemical, corrosion, and abrasion resistance
- Hygienic design reduces retention zones for
- Easy cleaning
- NPT, BSPT, BSPP, and metric threads

Markets:

- Petrochemical
- Life Science
- Pulp and Paper
- Food Processing
- Wash Down

Applications:

- Food Fluids
- Chemicals
- Cleaning Agents

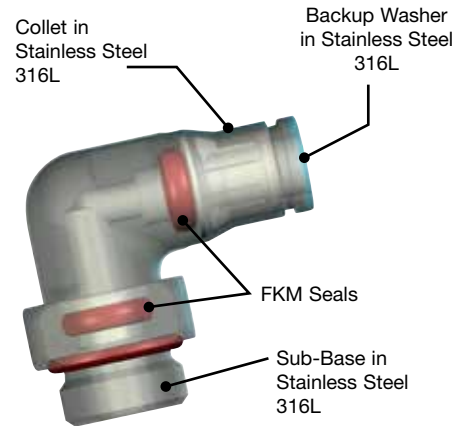

Specifications:

Pressure Range Up to 435 psi (30 bar)
Maximum working pressure and temperature range are dependent on the type of tubing used

Temperature Range -13° to 302° F (-25° to 150° C)

Vacuum Capability 28" Hg

Compatible Tubing:

- Semi-rigid nylon
- Polyethylene
- Polyurethane 95 Durometer Shore A
- Fluoropolymer
- Stainless Steel (when grooved)
- Copper (when grooved)

■ Threaded Fittings

3805
Male Connector
Taper
p. A66



3801
Male Connector
UNF, Parallel
and Metric
p. A66



3889
Male Elbow
Taper
p. A67



3879
Male Elbow
Parallel
p. A67



3809
Extended Male
Elbow
Taper
p. A68



3899
Extended Male
Elbow – UNF,
Parallel and Metric
p. A68



3893
Male Run Tee
BSPP/M5
p. A68



3821
Male Standpipe
Taper
p. A69



3831
Male Standpipe
Parallel and Metric
p. A69



■ Tube to Tube Fittings

3806
Union
p. A70



3802
Union Elbow
p. A70



3804
Union Tee
p. A70



3816
Bulkhead Union
p. A71



■ Accessories

3866
Reducer
p. A71



3826
Plug
p. A71



0683
Taper
p. A71



0682
Parallel
p. A71



3800 70 00
Groove Tool
p. A71



[Click here for CADs, Product Specifications or to Configure Parts Online](#)

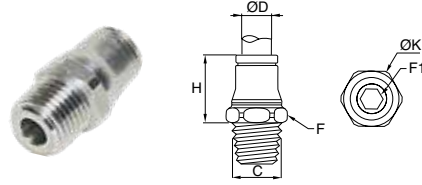

3805 Male Connector Fractional Inch Tube to NPT

PART NO.	ØD IN	C NPT	F IN	F1 IN	H IN	K IN
3805 04 11	5/32	1/8	10	3	.61	.43
3805 55 11	3/16	1/8	10	3	.61	.43
3805 56 11	1/4	1/8	13	4	.75	.55
3805 56 14	1/4	1/4	14	4	.69	.59
3805 08 11	5/16	1/8	15	4	.79	.65
3805 08 14	5/16	1/4	15	6	.79	.65
3805 60 14	3/8	1/4	19	6	.98	.83
3805 60 18	3/8	3/8	19	7	.94	.83
3805 62 14	1/2	1/4	22	7	1.02	.94
3805 62 18	1/2	3/8	22	8	.98	.94
3805 62 22	1/2	1/2	22	10	.98	.94

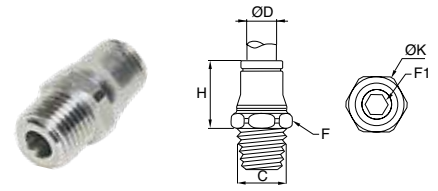

3805 Male Connector Metric Tube to BSPT

PART NO.	ØD MM	C BSPT	F MM	F1 MM	H MM	K MM
3805 04 10	4	R1/8	10	3	14.5	11
3805 04 13	4	R1/4	14	3	14.5	11
3805 06 10	6	R1/8	13	4	18	14
3805 06 13	6	R1/4	14	4	16.5	15
3805 08 10	8	R1/8	15	5	19	16.5
3805 08 13	8	R1/4	15	6	18	16.5
3805 08 17	8	R3/8	17	6	18.5	18.5
3805 10 13	10	R1/4	19	6	24	21
3805 10 17	10	R3/8	19	7	22.5	21
3805 12 13	12	R1/4	22	7	25	24
3805 12 17	12	R3/8	22	8	24	24
3805 12 21	12	R1/2	22	10	23	24

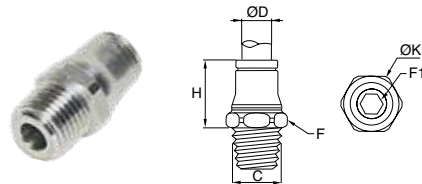

3805 Male Connector Metric Tube to NPT

PART NO.	ØD MM	C NPT	F MM	F1 MM	H MM	K MM
3805 04 11	4	1/8	11	3	14.5	12
3805 06 11	6	1/8	13	4	18	14
3805 06 14	6	1/4	14	4	16.5	15
3805 08 11	8	1/8	15	5	19	16.5
3805 08 14	8	1/4	15	6	18	16.5
3805 10 14	10	1/4	19	6	24	21
3805 10 18	10	3/8	19	7	22.5	21
3805 12 14	12	1/4	22	7	25	24
3805 12 18	12	3/8	22	8	24	24
3805 12 22	12	1/2	22	10	23	24

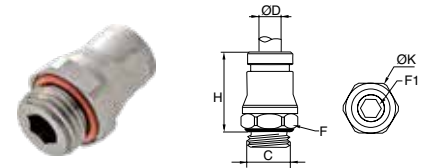

3801 Male Connector Tube to UNF, BSPP or M5

PART NO.	ØD IN	C UNF	F MM	F1 MM	H IN	K IN
3801 04 20	5/32	10-32	10	2.5	.59	.43

PART NO.	ØD MM	C BSPP/M5	F MM	F1 MM	H MM	K MM
3801 04 19	4	M5X0.8	10	2.5	16	11
3801 04 10	4	G1/8	13	3	15	14
3801 06 10	6	G1/8	13	4	18	14
3801 06 13	6	G1/4	17	4	18	18.5
3801 06 19	6	M5X0.8	13	2.5	20.5	14
3801 08 10	8	G1/8	15	5	19	16.5
3801 08 13	8	G1/4	17	5	20.5	18.5
3801 08 17	8	G3/8	21	6	20	23
3801 10 13	10	G1/4	19	7	25	21
3801 10 17	10	G3/8	21	7	25	23
3801 12 13	12	G1/4	21	7	27	23
3801 12 17	12	G3/8	21	9	26.5	23

WARNING These products can expose you to chemicals including LEAD which is known to the state of California to cause cancer.

[Click here for CADs, Product Specifications or to Configure Parts Online](#)

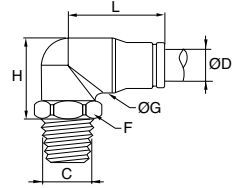
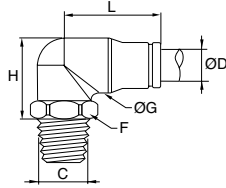

3889 Male Elbow Fractional Inch Tube to NPT

PART NO.	ØD IN	C NPT	F MM	G IN	H IN	L IN
3889 04 11	5/32	1/8	13	.39	.77	.77
3889 56 11	1/4	1/8	13	.47	.85	.91
3889 56 14	1/4	1/4	14	.47	.85	.91
3889 08 11	5/16	1/8	15	.59	1.00	.98
3889 08 14	5/16	1/4	15	.59	1.00	.98
3889 60 14	3/8	1/4	17	.69	1.12	1.20
3889 60 18	3/8	3/8	19	.69	1.12	1.20
3889 62 14	1/2	1/4	22	.79	1.34	1.30
3889 62 18	1/2	3/8	22	.79	1.34	1.30
3889 62 22	1/2	1/2	22	.79	1.34	1.30

3889 Male Elbow Metric Tube to BSPT

PART NO.	ØD MM	C BSPT	F MM	G MM	H MM	L MM
3889 04 10	4	R1/8	13	11	18	19
3889 04 13	4	R1/4	14	11	18	19
3889 06 10	6	R1/8	13	12	20	24
3889 06 13	6	R1/4	14	12	20	23
3889 08 10	8	R1/8	13	14.5	24.5	32
3889 08 13	8	R1/4	14	14.5	23.5	24
3889 08 17	8	R3/8	19	15	23	25
3889 10 13	10	R1/4	17	17	27	31
3889 10 17	10	R3/8	19	17	26	31
3889 12 13	12	R1/4	22	20	31.5	33
3889 12 17	12	R3/8	22	20	32.5	33
3889 12 21	12	R1/2	22	20	27.5	33

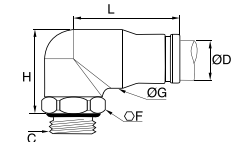
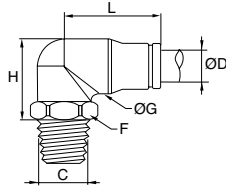

3889 Male Elbow Metric Tube to NPT

PART NO.	ØD IN	C NPT	F MM	G IN	H IN	L IN
3889 04 11	4	1/8	13	10	17.5	19
3889 06 11	6	1/8	13	12.5	20	22.5
3889 06 14	6	1/4	14	12.5	20	22.5
3889 08 11	8	1/8	13	15	25	24
3889 08 14	8	1/4	14	15	24	24
3889 10 14	10	1/4	17	17.5	27.5	27.5
3889 10 18	10	3/8	19	17.5	28.5	26.5
3889 12 14	12	1/4	22	20	31.5	32.5
3889 12 18	12	3/8	22	20	32.5	32.5
3889 12 22	12	1/2	22	20	27.5	32.5

3879 Male Elbow Metric Tube to BSPP

PART NO.	ØD MM	C BSPP	F MM	G MM	H MM	L MM
3879 04 10	4	G1/8	10	11	22	19
3879 04 13	4	G1/4	17	11	20	19
3879 06 10	6	G1/8	13	12	24	24
3879 06 13	6	G1/4	17	12	22	24
3879 08 10	8	G1/8	13	15	25	25
3879 08 13	8	G1/4	17	15	25	25
3879 08 17	8	G3/8	21	15	23	25
3879 10 13	10	G1/4	18	17	43	31
3879 10 17	10	G3/8	21	17	40	31
3879 12 13	12	G1/4	17	20	33	33
3879 12 17	12	G3/8	21	20	33	33
3879 12 21	12	G1/2	24	20	30	33

WARNING These products can expose you to chemicals including LEAD which is known to the state of California to cause cancer.

[Click here for CADs, Product Specifications or to Configure Parts Online](#)



**3809 Extended Male Elbow
Metric Tube to NPT**

PART NO.	ØD MM	C NPT	F MM	G MM	H MM	L MM
3809 04 11	4	1/8	11	10	25.5	18.5
3809 06 11	6	1/8	13	12.5	29	22.5
3809 06 14	6	1/4	14	12.5	29	22.5
3809 08 11	8	1/8	14	15	34	24
3809 08 14	8	1/4	14	15	34	24
3809 10 14	10	1/4	19	17.5	39.5	30
3809 10 18	10	3/8	19	17.5	39.5	30

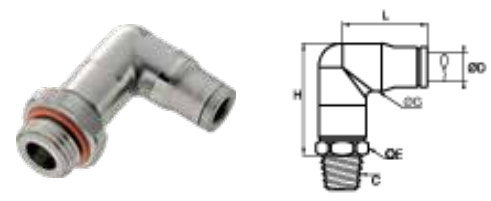

**3899 Extended Male Elbow
Fractional Inch Tube to UNF**

PART NO.	ØD IN	C UNF	F MM	G IN	H IN	L IN
3899 04 20	5/32	10-32	10	.39	.98	.77



**3809 Extended Male Elbow
Metric Tube to BSPT**

PART NO.	ØD MM	C BSPT	F MM	G MM	H MM	L MM
3809 04 10	4	R1/8	10	11	25	19
3809 04 13	4	R1/4	14	11	26	19
3809 06 10	6	R1/8	13	12	30	24
3809 06 13	6	R1/4	14	12	30	24
3809 08 10	8	R1/8	14	14.5	34	24.9
3809 08 13	8	R1/4	14	14.5	34	24.9
3809 10 13	10	R1/4	19	17.5	39	31
3809 10 17	10	R3/8	19	17.5	39	31



**3899 Extended Male Elbow
Metric Tube to BSPP or M5**

PART NO.	ØD MM	C BSPP/M5	F MM	G MM	H MM	L MM
3899 04 19	4	M5X0.8	10	10	26	18
3899 04 10	4	G1/8	13	10	27	19
3899 04 13	4	G1/4	17	27	27	19
3899 06 19	6	M5X0.8	13	12	33	24
3899 06 10	6	G1/8	6	12	33	24
3899 06 13	6	G1/4	17	12	32	24
3899 08 10	8	G1/8	14	15	35	25
3899 08 13	8	G1/4	17	15	35	25
3899 08 17	8	G3/8	21	15	34.5	25
3899 10 13	10	G1/4	19	17	43	31
3899 10 17	10	G3/8	21	17	42	31

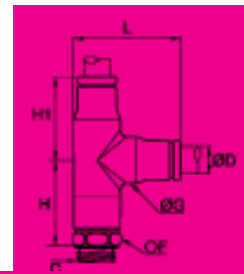

**3893 Male Run Tee Metric Tube
to BSPP or M5**

PART NO.	ØD MM	C BSPP/M5	F MM	G MM	H1 MM	H2 MM	L M
3893 08 13	8	G1/4	17	15	28	25	33.5
3893 08 17	8	G3/8	21	15	27	25	35.5
3893 10 13	10	G1/4	19	17	31	34	39

WARNING These products can expose you to chemicals including LEAD which is known to the state of California to cause cancer.

[Click here for CADs, Product Specifications or to Configure Parts Online](#)

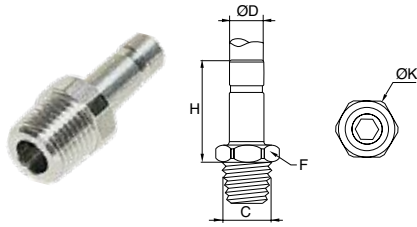

3821 Male Standpipe Fractional Inch Tube to NPT

PART NO.	ØD IN	C NPT	F IN	H IN	K IN
3821 04 11	5/32	1/8	.39	.98	.21
3821 56 11	1/4	1/8	.39	1.02	.35
3821 56 14	1/4	1/4	.55	1.06	.63
3821 08 11	5/16	1/8	.43	1.06	.42
3821 08 14	5/16	1/4	.55	1.06	.71
3821 60 14	3/8	1/4	.75	1.26	.71
3821 60 18	3/8	3/8	.75	1.26	1.06
3821 62 14	1/2	1/4	.75	1.42	1.34
3821 62 18	1/2	3/8	.75	1.46	1.34
3821 62 22	1/2	1/2	.87	1.46	1.98

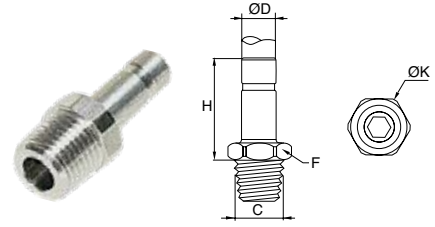

3821 Male Standpipe Metric Tube to BSPT

PART NO.	ØD MM	C BSPT	F MM	H MM
3821 04 10	4	R1/8	10	21
3821 06 10	6	R1/8	10	23
3821 06 13	6	R1/4	14	24
3821 08 10	8	R1/8	11	24
3821 08 13	8	R1/4	14	25
3821 10 13	10	R1/4	19	30
3821 10 17	10	R3/8	19	30
3821 12 13	12	R1/4	19	31
3821 12 17	12	R3/8	19	31
3821 12 21	12	R1/2	22	32

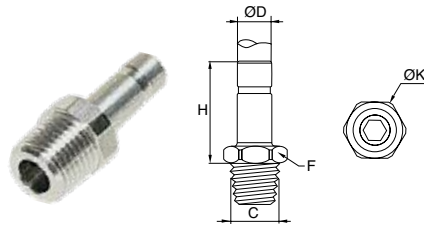

3821 Male Standpipe Metric Tube to NPT

PART NO.	ØD1 MM	C NPT	F MM	H MM	K MM
3821 04 11	4	1/8	11	21	12
3821 06 11	6	1/8	11	23	12
3821 06 14	6	1/4	14	24	15
3821 08 11	8	1/8	14	24	15
3821 08 14	8	1/4	14	25	15
3821 10 14	10	1/4	14	30	15
3821 10 18	10	3/8	17	30	18.5

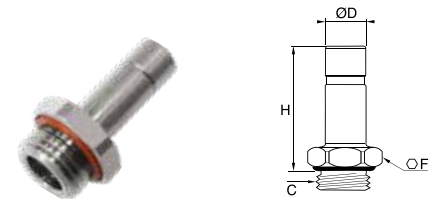

3831 Male Standpipe Tube to BSPP or M5

PART NO.	ØD MM	C BSPP/M5	F MM	H MM
3831 04 19	4	M5X0.8	7	23.5
3831 04 10	4	G1/8	13	22
3831 06 10	6	G1/8	13	24
3831 06 13	6	G1/4	17	24
3831 08 10	8	G1/8	13	25
3831 08 13	8	G1/4	17	27
3831 08 17	8	G3/8	21	27
3831 10 13	10	G1/4	17	32
3831 10 17	10	G3/8	21	27
3831 12 13	12	G1/4	17	33
3831 12 17	12	G3/8	21	33
3831 12 21	12	G1/2	24	36

WARNING These products can expose you to chemicals including LEAD which is known to the state of California to cause cancer.

[Click here for CADs, Product Specifications or to Configure Parts Online](#)

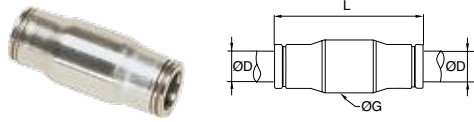

3806 Straight Union Fractional Inch Tube to Tube

PART NO.	ØD IN	G IN	L IN
3806 04 00	5/32	.39	1.18
3806 55 00	3/16	.39	1.18
3806 56 00	1/4	.47	1.38
3806 08 00	5/16	.59	1.46
3806 60 00	3/8	.69	1.81
3806 62 00	1/2	.79	1.89

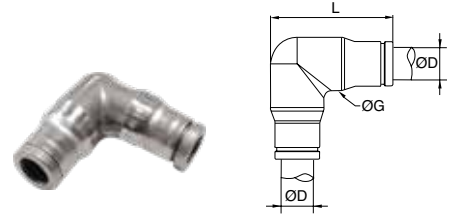

3802 Union Elbow Metric Tube to Tube

PART NO.	ØD MM	G MM	L MM
3802 04 00	4	10	24
3802 06 00	6	12	30
3802 08 00	8	14.5	32.2
3802 10 00	10	17	39
3802 12 00	12	20	43

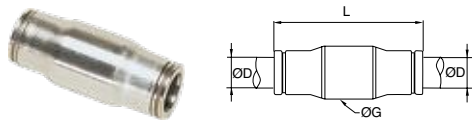

3806 Straight Union Metric Tube to Tube

PART NO.	ØD IN	G IN	L IN
3806 04 00	4	10	29
3806 06 00	6	12	34
3806 08 00	8	15	36
3806 10 00	10	17.5	45
3806 12 00	12	20	46.5

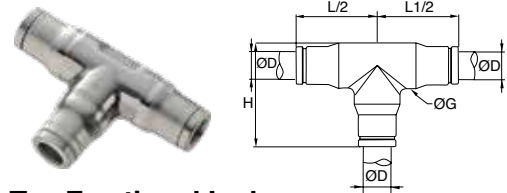

3804 Union Tee Fractional Inch Tube to Tube to Tube

PART NO.	ØD IN	G IN	L IN
3804 56 00	1/4	1.06	.83
3804 60 00	3/8	1.48	1.12
3804 62 00	1/2	1.61	1.22

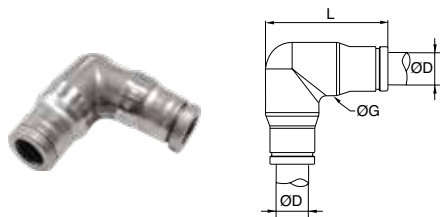

3802 Union Elbow Fractional Inch Tube to Tube

PART NO.	ØD IN	G IN	L IN
3802 04 00	5/32	.39	.96
3802 56 00	1/4	.47	1.14
3802 08 00	5/16	.59	1.28
3802 60 00	3/8	.69	1.56
3802 62 00	1/2	.79	1.61

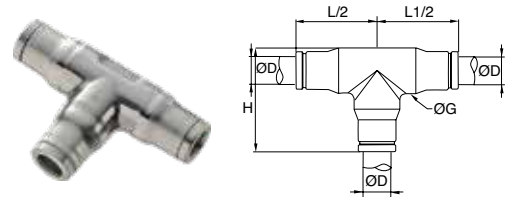

3804 Union Tee Metric Tube to Tube to Tube

PART NO.	ØD MM	G MM	H MM	L MM
3804 04 00	4	11	24	19
3804 06 00	6	12	30	24
3804 08 00	8	14.5	32	25
3804 10 00	10	17	39	31
3804 12 00	12	20	43	33

WARNING These products can expose you to chemicals including LEAD which is known to the state of California to cause cancer.

[Click here for CADs, Product Specifications or to Configure Parts Online](#)

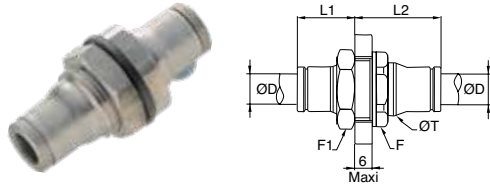

3816 Bulkhead Union Fractional Inch Tube to Tube

PART NO.	ØD IN	F MM	F1 MM	L1 IN	L2 IN	T IN
3816 04 00	5/32	13	14	.59	.83	.49
3816 55 00	3/16	17	13	.59	.83	.49
3816 56 00	1/4	19	17	.67	.89	.57
3816 08 00	5/16	19	19	.75	.94	.63
3816 60 00	3/8	27	22	.87	1.08	.83
3816 62 00	1/2	27	27	.94	1.14	1.00

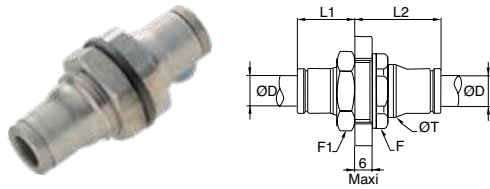

3816 Bulkhead Union Metric Tube to Tube

PART NO.	ØD IN	F MM	F1 MM	L1 IN	L2 IN	T IN
3816 04 00	4	13	14	13.5	19.5	12.5
3816 06 00	6	17	17	16.5	21.5	14.5
3816 08 00	8	19	19	18	24	16.5
3816 10 00	10	22	22	21.5	27.5	20.5
3816 12 00	12	24	24	24	29	22.5

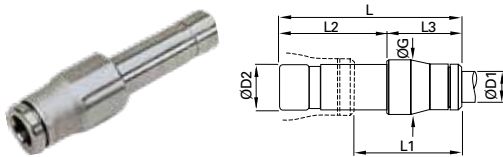

3866 Reducer Metric

PART NO.	ØD1 MM	ØD2 MM	G MM	L MM	L2 MM	L2 MM	L3 MM
3866 04 06	4	6	10	35	19	19	16
3866 04 08	4	8	10	34	17	20	14
3866 06 08	6	8	12	42	24	23	19
3866 06 10	6	10	12	41	19	25	16
3866 08 10	8	10	15	45	22.5	25	20
3866 08 12	8	12	15	43	20	26	17
3866 10 12	10	12	17	51	23	26	24

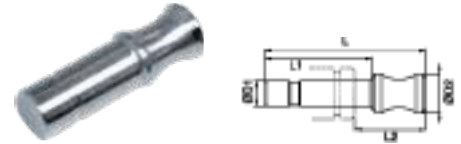

3826 Plug Metric

PART NO.	ØD1 MM	ØD2 MM	L MM	L1 MM	L2 MM
3826 04 00	4	6	25	17	11
3826 06 00	6	8	30.4	19.5	13.5
3826 08 00	8	10	33	20	14
3826 10 00	10	12	40	25	17
3826 12 00	12	14	43	26	19

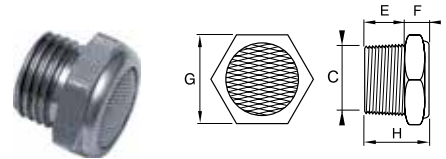

0683 Stainless Steel Threaded Silencer Male NPT

PART NO.	C NPT	E IN	F IN	G MM	H IN
0683 00 11	1/8	.28	.28	14	.55
0683 00 14	1/4	.43	.28	17	.71
0683 00 18	3/8	.43	.31	22	.75
0683 00 22	1/2	.59	.39	27	.98

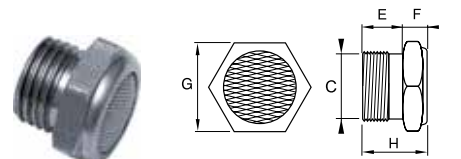

0682 Stainless Steel Threaded Silencer Male BSPP

PART NO.	C BSPP	E IN	F IN	G MM	H IN
0682 00 10	G1/8	8	7	14	15
0682 00 13	G1/4	8	7	17	15
0682 00 17	G3/8	10	8	22	18
0682 00 21	G1/2	12	10	27	22
0682 00 27	G3/4	15	12	32	27
0682 00 34	G1	18	14	38	32

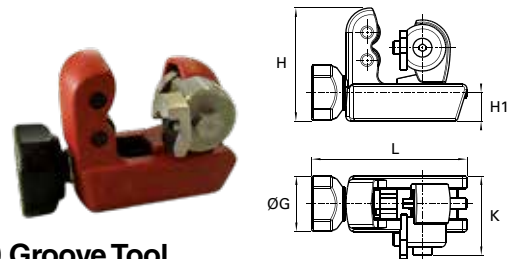

3800 70 00 Groove Tool

PART NO.	H MM	H1 MM	L MM
3800 70 00	25	20	96

In cases where access is difficult this tool can be useful, particularly if the standard release buttons have been removed. (Release buttons can only be removed on 3/16 sizes.)

WARNING These products can expose you to chemicals including LEAD which is known to the state of California to cause cancer.



Pneumatic: Integrated Fittings

Compact Flow Controls
Miniature Flow Controls
Swivel Outlet Flow Controls
Plug-In Flow Controls
In-Line Flow Controls
Metal Flow Controls
Stainless Steel Flow Controls
In-Line Check Valves
Stainless Steel Check Valves
Piloted Operated Check Valves
Pneumatic Slide Valves
Quick Exhaust Valve
Blocking Valves
Threshold Sensor Fittings
Mini Ball Valves
Pressure Regulators
Manually-Operated Valves



GOODYEAR
RUBBER PRODUCTS, INC.

☎ 727-342-5088

You can also email us at
GRP@goodyearrubberproducts.com

■ Compact Flow Controls

7065

Compact
p. A80



7060

Compact
p. A81



7067

Compact
p. A81



7062

Compact
p. A81



7066

Compact
p. A81



7061

Compact
p. A82



7015/7016

Knobless
p. A83



7010/7011

Knobless
p. A83



7012

Knobless
p. A83



7045

Compact
Swivel Outlet
p. A88



7640/7645

Mini Swivel Outlet
p. A88



7040/7041

Compact
Swivel Outlet
p. A88



7640/7649

Mini Swivel Outlet
p. A88



■ Miniature Flow Controls

7665/7668

Miniature
p. A85



7660/7669

Miniature
p. A85



7665/7668

Miniature
p. A85



7660/69/62

Miniature
p. A86



7625

Knobless Mini
p. A86



7620

Knobless Mini
p. A86



■ Plug-In Flow Controls

7630/7631

Plug-In Mini
p. A90



7030/7031

Plug-In Compact
p. A90



■ In-Line Flow Controls

7770/7772

In-Line
p. A92



7776

In-Line
p. A92



7775

In-Line
p. A93



7771

In-Line
p. A93



■ Metal Flow Controls

7105

p. A95



7100/7101

p. A95



7115

p. A95



7110/7111

p. A95



7160

p. A95



■ **Stainless Steel Flow Controls**

7835
p. A97



7810/7812
7815/7817
p. A97



7810/7812
p. A97



■ **Check Valves**

7996
p. A99



7984/94/85/95
p. A99



7985/7995
p. A99



7984/7994
p. A99



VC
p. A99



■ **Stainless Steel Check Valves**

4890
p. A101



4891
p. A101



4892
p. A101



4895
p. A101



■ **Piloted Operated Check Valves**

7892
p. A103



7894
p. A103



■ **Pneumatic Slide Valves**

0661
Male/Female
p. A105



0660/0669
Double Female
p. A105



■ **Quick Exhaust Valve**

7982
p. A106



■ **Blocking Valves**

7885
p. A108



7880
p. A108



7886
p. A108



7881
p. A108



■ **Threshold Sensors**

7808
p. A115



7818
p. A115



7828/7829
p. A116



7828
p. A116



■ **Mini Ball Valves**

7913
p. A118



7915
NPT
p. A118



7914
BSPP
p. A118



7910
p. A118



7911
BSPP
p. A118



■ **Pressure Regulator Fittings**

7305
p. A120



7300
p. A120



■ **Manually Operated 3-Way Venting Valves**

7805/7806
p. A122



7800/7801
p. A122



Compact Flow Controls



Parker's compact flow controls ensure excellent performance of flow and are perfectly suited for reduced spaces due to their small size.

Product Features:

- Glass reinforced nylon 6.6 body
- Stainless steel gripping ring
- Nickel-plated brass adjustment screw
- Nickel-plated brass locking nut
- Nickel-plated brass threads
- Nitrile D seal
- NPT
- BSPT
- BSPP
- Metric threads

Markets:

- Factory/Process Automation
- Life Science
- Food Processing
- Water And Beverage
- Petrochemical

Applications:

- Packaging
- Filling
- Dispensing
- Bottling
- Pneumatic Circuits

Specifications:

Pressure Range 15 to 145 psi (1.0 to 9.9 bar)

Temperature Range +30° to +160° F (-1.1 to +71.1° C)

Compatible Tubing:

- Semi-rigid nylon
- Polyurethane 95 Durometer Shore A
- Nylon
- Fluoropolymer

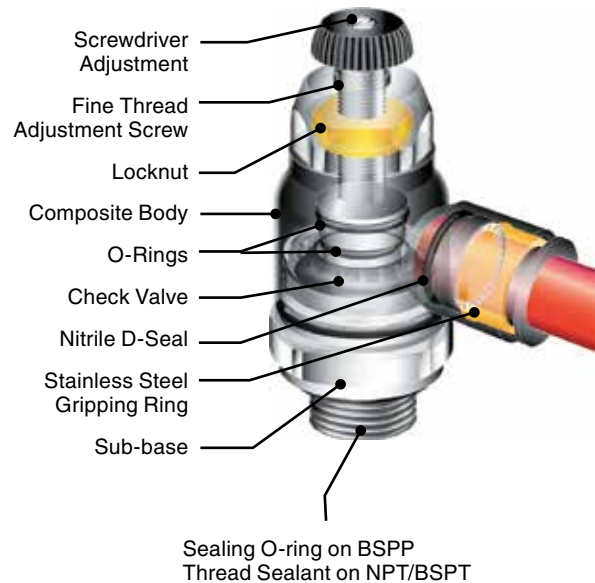

Assembly Instructions

1. Cut tubing squarely – maximum of 15° angle allowable.
2. Check that port or mating part is clean and free of debris.
3. Mark tubing to appropriate tube insertion length. (see Tube Insertion Chart on page N22)
4. Insert tubing until it bottoms
5. Pull on tubing to verify it is fully inserted
6. To disassemble, simply press release button, hold against body and pull tubing out of fitting.

Click here for CADs, Product Specifications or to Configure Parts Online

meter out version

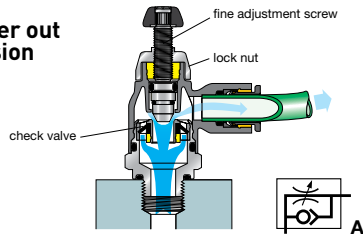

meter in version

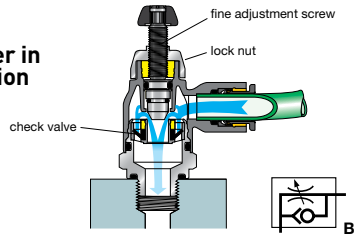

bi-directional version

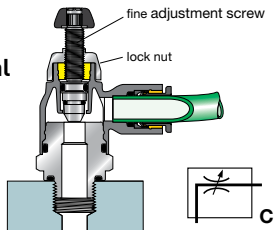

Compact Type

Manufactured with robust materials, compact flow control regulators ensure excellent performance of flow and are perfectly suited for reduced spaces due to their small size.

The sensitivity of the adjustment screw provides very precise air flow control and regulation. A locking nut guarantees stability of adjustment against vibration tampering of the flow setting. The adjustment screw and locking nut have been designed for easy manipulation, by hand. Adjustment can be made with a screwdriver and locking by use of a wrench.

Quick Identification of Legris Flow Control Regulators

To assist differentiation, each version is identified by the corresponding pneumatic symbol and a letter:

- **one-way** adjustment
 - **meter out** version: letter **A**
 - **meter in** version: letter **B**
- **bi-directional** adjustment: letter **C**

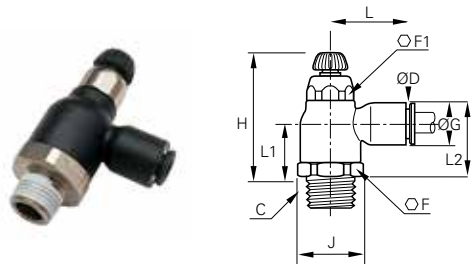

7065 Compact Meter Out Flow Control Tube to NPT or BSPT

PART NO.	ØD IN	C NPT	F IN	F1 IN	G IN	H MIN IN	H MAX IN	J IN	L IN	L1 IN	L2 IN	W OZ
7065 04 11	5/32	1/8	.63	.39	.43	1.44	1.67	.69	.85	.59	.79	.79
7065 04 14	5/32	1/4	.63	.39	.43	1.44	1.67	.69	.85	.59	.79	.79
7065 56 11	1/4	1/8	.63	.39	.43	1.44	1.67	.69	.85	.59	.79	.79
7065 56 14	1/4	1/4	.63	.39	.43	1.44	1.67	.69	.85	.59	.79	.97
7065 60 14	3/8	1/4	.91	.67	.63	1.71	2.03	.98	1.22	.71	1.02	2.15
7065 60 18	3/8	3/8	.91	.67	.63	1.71	2.03	.98	1.22	.71	1.02	2.22
7065 60 22	3/8	1/2	.91	.67	.63	1.71	2.03	.98	1.22	.71	1.02	2.22
7065 62 22	1/2	1/2	.91	.67	.63	1.71	2.03	.98	1.22	.71	1.02	2.22

PART NO.	ØD MM	BSPT	F MM	F1 MM	G MM	H MIN MM	H MAX MM	J MM	L MM	L1 MM	L2 MM	W KG
7065 06 10	6	R1/8	16	10	11	36.5	42.5	17.5	22	15	20	.021
7065 08 10	8	R1/8	19	14	13.5	40	45	21	27	16.5	23.5	.035
7065 08 13	8	R1/4	19	14	13.5	40	45	21	27	16.5	23.5	.037
7065 10 13	10	R1/4	23	17	16	43.5	51.5	25	31.5	18	26	.057
7065 10 17	10	R3/8	23	17	16	43.5	51.5	25	31.5	18	26	.059
7065 10 21	10	R1/2	23	17	16	43.5	51.5	25	31.5	18	26	.060
7065 12 13	12	R1/4	23	17	19	43.5	51.5	25	35	18	27.5	.063
7065 12 17	12	R3/8	23	17	19	43.5	51.5	25	35	18	27.5	.063
7065 12 21	12	R1/2	23	17	19	43.5	51.5	25	35	18	27.5	.065

⚠ WARNING These products can expose you to chemicals including NICKEL, CARBON BLACK, TITANIUM DIOXIDE, or LEAD, which are known to the state of

[Click here for CADs, Product Specifications or to Configure Parts Online](#)

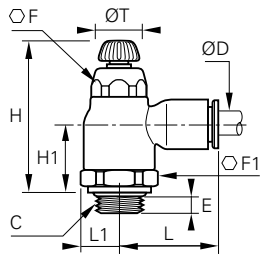

7060 Compact Meter Out Flow Control Metric Tube to BSPP

PART NO.	ØD MM	C BSPP	E MM	F MM	F1 MM	H MIN MM	H MAX MM	H1 MM	L MM	L1 MM	T MM	W KG
7060 04 10	4	G1/8	5	10	16	38	44	16	22	9	10	.021
7060 06 10	6	G1/8	5	10	16	38	44	16	22	9	10	.021
7060 06 13	6	G1/4	5.5	10	16	36.5	42.5	15	22	9	10	.021
7060 08 10	8	G1/8	4.5	14	19	41.5	48	18	28	10.5	12	.035
7060 08 13	8	G1/4	5.5	14	19	41.5	48	18.5	28	10.5	12	.037
7060 08 17	8	G3/8	5.5	14	19	41.5	48	17	28	11	12	.037
7060 10 13	10	G1/4	5.5	17	23	45.5	53.5	20	31.5	12.5	17	.057
7060 10 17	10	G3/8	5.5	17	23	45.5	54	20	31.5	12.5	17	.059
7060 12 17	12	G3/8	5.5	17	23	45.5	54	20	35	12.5	17	.063
7060 12 21	12	G1/2	7.5	17	24	45.5	54	20	35	13	17	.065

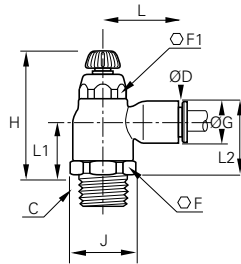

7067 Compact Bi-Directional Flow Control Tube to NPT or BSPT

PART NO.	ØD IN	C NPT	F IN	F1 IN	G IN	H MIN IN	H MAX IN	J IN	L IN	L1 IN	L2 IN	W OZ
7067 04 11	5/32	1/8	.63	.39	.43	1.44	1.67	.69	.85	.59	.79	.79
7067 56 11	1/4	1/8	.63	.39	.43	1.44	1.67	.69	.85	.59	.79	.79
7067 56 14	1/4	1/4	.63	.39	.43	1.44	1.67	.69	.85	.59	.79	.79

PART NO.	ØD MM	C BSPT	F MM	F1 MM	G MM	H MIN MM	H MAX MM	J MM	L IN	L1 MM	L2 MM	W KG
7067 04 10	4	R1/8	16	10	11	36.5	42.5	17.5	22	14.7	20.5	.021
7067 06 10	6	R1/8	16	10	11	36.5	42.5	17.5	22	14.7	20.5	.021
7067 06 13	6	R1/4	16	10	11	36.5	42.5	17.5	22	14.7	20.5	.021
7067 08 10	8	R1/8	19	14	13.5	40	45	21	27	16.5	23.5	.035
7067 08 13	8	R1/4	19	14	13.5	40	45	21	27	16.5	23.5	.037
7067 08 17	8	R3/8	19	14	13.5	40	45	22	27	16.5	23.5	.037

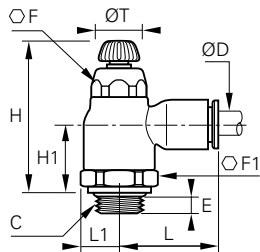

7062 Compact Bi-Directional Flow Control Metric Tube to BSPP

PART NO.	ØD MM	C BSPP	E MM	F MM	F1 MM	H MIN MM	H MAX MM	H1 MM	L MM	L1 IN	T MM	W KG
7062 04 10	4	G1/8	5	10	16	38	44	16	22	9	10	.021
7062 06 10	6	G1/8	5	10	16	38	44	16	22	9	10	.021
7062 06 13	6	G1/4	5.5	10	16	36.5	42.5	15	22	9	10	.021
7062 08 10	8	G1/8	4.5	14	19	41.5	48	18	28	10.5	12	.035
7062 08 13	8	G1/4	5.5	14	19	41.5	48	18.5	28	10.5	12	.037
7062 08 17	8	G3/8	5.5	14	19	41.5	48	17	28	11	12	.037

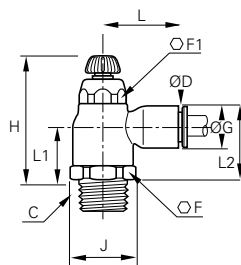

7066 Compact Meter In Flow Control Tube to NPT or BSPT

PART NO.	ØD IN	C NPT	F IN	F1 IN	G IN	H MIN IN	H MAX IN	J IN	L IN	L1 IN	L2 IN	W OZ
7066 04 11	5/32	1/8	.63	.39	.43	1.44	1.67	.69	.85	.59	.79	.79
7066 04 14	5/32	1/4	.63	.39	.43	1.44	1.67	.69	.85	.59	.79	.79
7066 56 11	1/4	1/8	.63	.39	.43	1.44	1.67	.69	.85	.59	.79	.79
7066 56 14	1/4	1/4	.63	.39	.43	1.44	1.67	.69	.85	.59	.79	.97
7066 60 14	3/8	1/4	.91	.67	.63	1.71	2.03	.98	1.22	.71	1.02	2.15
7066 60 18	3/8	3/8	.91	.67	.63	1.71	2.03	.98	1.22	.71	1.02	2.22

WARNING These products can expose you to chemicals including NICKEL, CARBON BLACK, TITANIUM DIOXIDE, or LEAD, which are known to the state of

Click here for CADs, Product Specifications or to Configure Parts Online

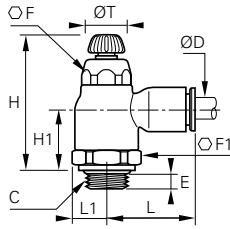

7061 Compact Meter In Flow Control Metric Tube to BSPP

PART NO.	ØD MM	C BSPP	E MM	F MM	F1 MM	H MIN MM	H MAX MM	H1 MM	L IN	L1 MM	T MM	W KG
7061 04 10	4	G1/8	5	10	16	38	44	16	22	9	10	.021
7061 06 10	6	G1/8	5	10	16	38	44	16	22	9	10	.021
7061 06 13	6	G1/4	5.5	10	16	36.5	42.5	15	22	9	10	.021
7061 08 10	8	G1/8	4.5	14	19	41.5	48	18	28	10.5	12	.035
7061 08 13	8	G1/4	5.5	14	19	41.5	48	18.5	28	10.5	12	.037
7061 08 17	8	G3/8	5.5	14	19	41.5	48	17	28	11	12	.037
7061 10 13	10	G1/4	5.5	17	23	45.5	53.5	20	31.5	12.5	17	.057
7061 10 17	10	G3/8	5.5	17	23	45.5	54	20	31.5	12.5	17	.059
7061 12 21	12	G1/2	7.5	17	24	45.5	54	20	35	13	17	.065

Knobless

meter out version

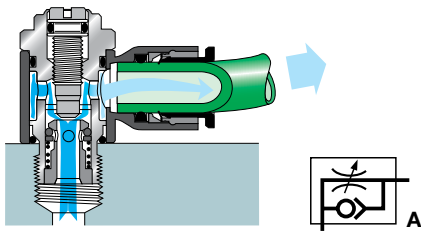

meter in version

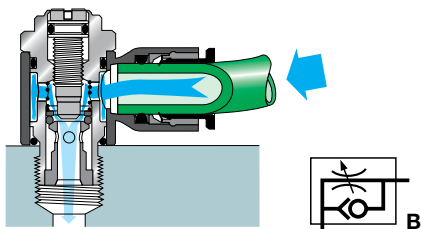

bi-directional adjustment

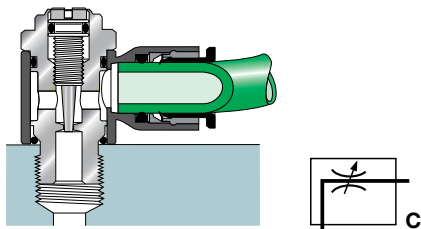

The recessed adjustment screw reduces external dimensions thus allowing use in reduced spaces and on small cylinders.

In addition, the recessed screw provides security and helps to prevent unwanted adjustment.

maximum tightening torque of models with recessed screw	Threads	M5 or 10/32	1/8	1/4	3/8	1/2
	in. lb	8	35	40	50	58

Quick Identification of Legris Flow Control Regulators

To assist differentiation, each version is identified by the corresponding pneumatic symbol and a letter:

- **one-way** adjustment
 - **meter out** version: letter **A**
 - **meter in** version: letter **B**
- **bi-directional** adjustment: letter **C**

⚠ WARNING These products can expose you to chemicals including NICKEL, CARBON BLACK, TITANIUM DIOXIDE, or LEAD, which are known to the state of

[Click here for CADs, Product Specifications or to Configure Parts Online](#)

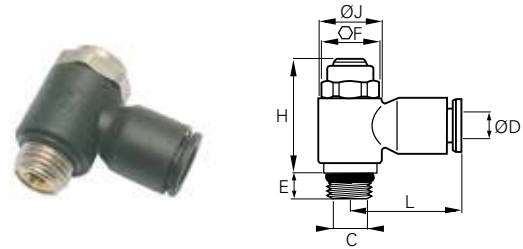
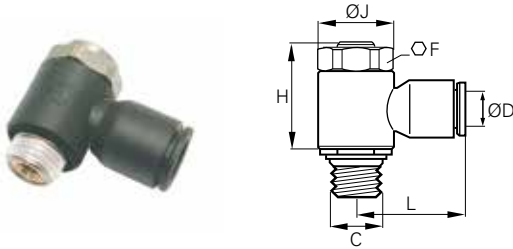

7015/7016 Knobless Compact Flow Control Fractional Inch Tube to NPT

PART NO. METER OUT	PART NO. METER IN	ØD IN	C NPT	F MM	H IN	J IN	L IN	W OZ
7015 53 11	-	1/8	1/8	13	.79	.55	.75	.60
7015 04 11	7016 04 11	5/32	1/8	13	.79	.55	.75	.60
7015 56 11	7016 56 11	1/4	1/8	13	.79	.55	.85	.67
7015 56 14	-	1/4	1/4	17	1.04	.75	.89	1.20
7015 08 11	-	5/16	1/8	13	.79	.55	1.02	.71
7015 08 14	-	5/16	1/4	17	1.04	.75	1.06	1.23
7015 60 14	-	3/8	1/4	17	1.04	.75	1.14	1.34
7015 60 18	-	3/8	3/8	20	1.14	.89	1.36	1.52

7010/7011 Knobless Compact Flow Control Fractional Inch Tube to UNF

PART NO. METER OUT	PART NO. METER IN	ØD IN	C UNF	E IN	F MM	H IN	J IN	L IN	W OZ
7010 53 20	-	1/8	10-32	.16	8	.69	.37	.65	.25
7010 04 20	-	5/32	10-32	.16	8	.69	.37	.65	.25
7010 56 20	7011 56 20	1/4	10-32	.16	8	.69	.37	.77	.60

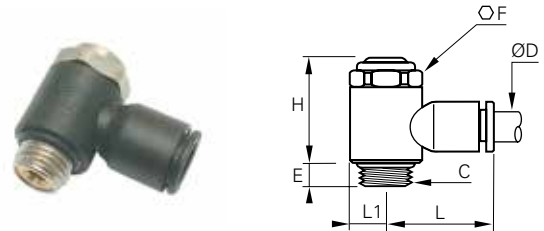
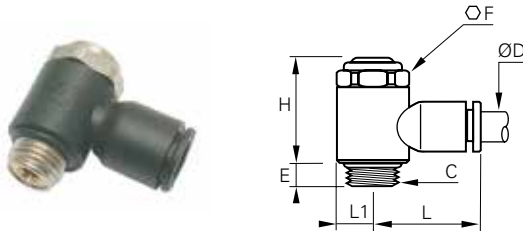

7010/7011 Knobless Compact Flow Control Metric Tube to BSPP or M5

PART NO. METER OUT	PART NO. METER IN	ØD IN	C BSPP/M5	E IN	F MM	H IN	L IN	L1 IN	W KG
7010 04 19	7011 04 19	4	M5X0.8	4	8	17.5	17	5	.007
7010 04 10	7011 04 10	4	G1/8	5	13	25	19	7	.017
7010 06 19	7011 06 19	6	M5X0.8	4	8	17.5	19	5	.017
7010 06 10	7011 06 10	6	G1/8	5	13	25	21	7	.019
7010 06 13	7011 06 13	6	G1/4	8	17	26.5	22	9.5	.034
7010 08 10	7011 08 10	8	G1/8	5	13	25	26	7	.020
7010 08 13	7011 08 13	8	G1/4	8	17	26.5	27	9.5	.035
7010 08 17	7011 08 17	8	G3/8	7.5	20	37.5	29	11.2	.042
7010 10 13	7011 10 13	10	G1/4	8	17	26.5	29	9.5	.038
7010 10 17	7011 10 17	10	G3/8	7.5	20	37.5	31	11.2	.043
7010 10 21	-	10	G1/2	8	23	43	37	13.5	.117
7010 12 17	-	12	G3/8	7.5	20	37.5	34.5	11.2	.045
7010 12 21	-	12	G1/2	8	23	43	37	13.5	.111

7012 Knobless Bi-Directional Flow Control Metric Tube to BSPP or M5

PART NO. BI-DIRECTIONAL	ØD MM	C BSPP/M5	E MM	F MM	H MM	L MM	L1 MM	W KG
7012 04 19	4	M5X0.8	4	8	17.5	17	5	.007
7012 04 10	4	G1/8	5	13	25	19	7	.017
7012 06 19	6	M5X0.8	4	8	17.5	19	5	.017
7012 06 10	6	G1/8	5	13	25	21	7	.019
7012 06 13	6	G1/4	8	17	26.5	22	9.5	.034
7012 08 10	8	G1/8	5	13	25	26	7	.020
7012 08 13	8	G1/4	8	17	26.5	27	9.5	.035
7012 08 17	8	G3/8	7.5	20	37.5	29	11.2	.042

WARNING: These products can expose you to chemicals including NICKEL, CARBON BLACK, TITANIUM DIOXIDE, or LEAD, which are known to the state of

Miniature Flow Controls



Parker's miniature flow controls ensure excellent performance of flow and are perfectly suited for reduced spaces due to their small size.

Product Features:

- Glass reinforced nylon 6.6 body
- Stainless steel gripping ring
- Nickel-plated brass adjustment screw
- Nickel-plated brass locking nut
- Nickel-plated brass threads
- Nitrile D seal
- NPT, BSPT, BSPP, Metric threads

Markets:

- Factory/Process Automation
- Life Science
- Food Processing
- Water And Beverage
- Petrochemical

Applications:

- Packaging
- Filling
- Dispensing
- Bottling
- Pneumatic Circuits

Specifications:

Pressure Range 15 to 145 psi (1.0 to 9.9 bar)

Temperature Range +30° to +160° F (-1.1 to +71.1° C)

Compatible Tubing:

- Semi-rigid nylon
- Polyurethane 95 Durometer Shore A
- Nylon
- Fluoropolymer

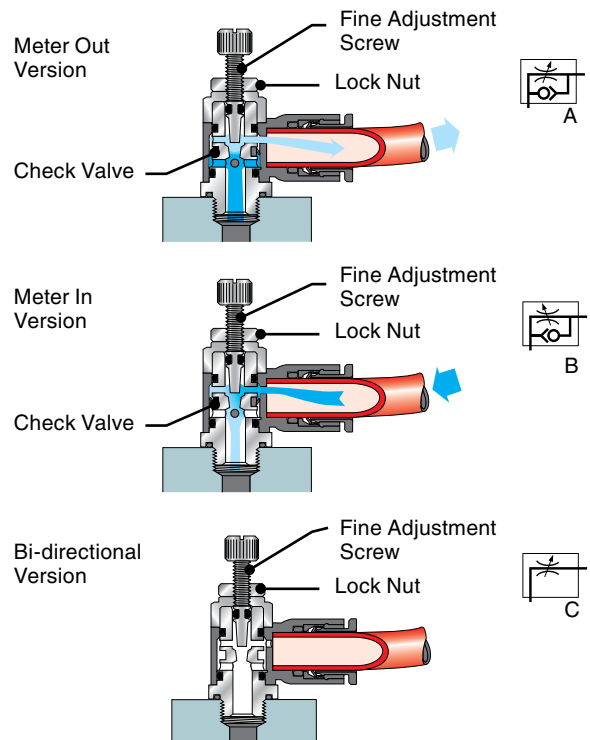

Assembly Instructions

1. Cut tubing squarely – maximum of 15° angle allowable.
2. Check that port or mating part is clean and free of debris.
3. Mark tubing to appropriate tube insertion length. (see Tube Insertion Chart on page N22)
4. Insert tubing until it bottoms
5. Pull on tubing to verify it is fully inserted
6. To disassemble, simply press release button, hold against body and pull tubing out of fitting.

[Click here for CADs, Product Specifications or to Configure Parts Online](#)

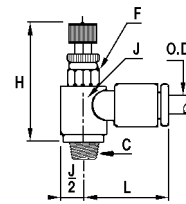
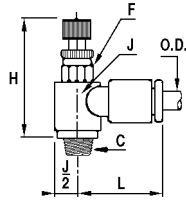

7665/7668 Miniature Flow Control Fractional Inch Tube to NPT

PART NO. METER OUT	PART NO. METER IN	ØD IN	C NPT	F MM	H MIN IN	H MAX IN	J IN	L IN	W OZ
7665 53 11	-	1/8	1/8	7	1.26	1.41	.45	.69	.42
7665 04 11	7668 04 11	5/32	1/8	7	1.06	1.16	.45	.71	.46
7665 56 11	7668 56 11	1/4	1/8	7	1.06	1.16	.45	.75	.64
7665 56 14	7668 56 14	1/4	1/4	8	1.18	1.28	.47	.77	.79

7665/7668 Miniature Flow Control Metric Tube to BSPT

PART NO. METER OUT	PART NO. METER IN	ØD MM	C BSPT	F MM	H MIN IN	H MAX IN	J IN	L IN	W OZ
7665 04 10	7668 04 10	4	R1/8	7	25	27.5	11.5	18	.46
7665 06 10	7668 06 10	6	R1/8	7	25	27.5	11.5	18.5	.64
7665 06 13	7668 06 13	6	R1/4	8	27.5	30	13.5	19	.79
7665 06 17*	-	6	R3/8	17	31.5	34	13.5	19	.85
7665 08 10	7668 08 10	8	R1/8	13	28.5	33	14	26	.90
7665 08 13	7668 08 13	8	R1/4	16	31	35	19	27.5	.93
7665 08 17	-	8	R3/8	20	36	42	23	29	.95

* on the 7665 06 17 the hex is right above the threads.

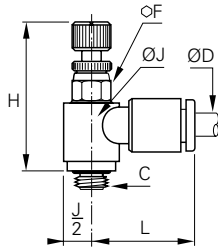

7660/7669 Miniature Flow Control Fractional Inch Tube to UNF

PART NO. METER OUT	PART NO. METER IN	ØD IN	C UNF	F MM	H MIN IN	H MAX IN	J IN	L IN	W OZ
7660 53 20	7669 53 20	1/8	10-32	6	.91	1.14	.35	.67	.23
7660 04 20	7669 04 20	5/32	10-32	6	.93	1.02	.35	.67	.23
7660 56 20	7669 56 20	1/4	10-32	6	.93	1.02	.35	.73	.25

WARNING These products can expose you to chemicals including NICKEL, CARBON BLACK, TITANIUM DIOXIDE, or LEAD, which are known to the state of

Click here for CADs, Product Specifications or to Configure Parts Online

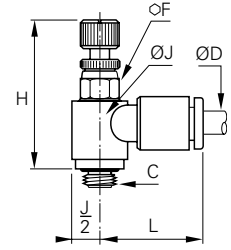

7660/7669/7662 Miniature Flow Control Metric Tube to BSPP or Metric

PART NO. METER OUT	PART NO. METER IN	PART NO. BI-DIRECTIONAL	ØD IN	C BSPP/METRIC	F MM	H MIN MM	H MAX MM	J MM	L MM	W KG
7660 03 09	7669 03 09	-	3	M3X0.5	6	23.5	26	9	17	.008
7660 03 19	7669 03 19	-	3	M5X0.8	6	23.5	26	9	17	.008
7660 04 09	-	-	4	M3X0.5	6	23.5	26	9	16.5	.007
7660 04 19	7669 04 19	7662 04 19	4	M5X0.8	6	23.5	26	9	17	.008
7660 04 10	7669 04 10	7662 04 10	4	G1/8	7	27	29.5	11.5	18	.012
7660 06 19	7669 06 19	7662 06 19	6	M5X0.8	6	23.5	26	9	18	.010
7660 06 10	7669 06 10	7662 06 10	6	G1/8	7	27	29.5	11.5	18.5	.012
7660 06 13	7669 06 13	7662 06 13	6	G1/4	8	30	32.5	12	19	.019
7660 08 10	7669 08 10	-	8	G1/8	13	26.5	31	14	26	.020
7660 08 13	7669 08 13	-	8	G1/4	16	29	34	19	27.5	.022
7660 08 17	7669 08 17	-	8	G3/8	20	36	42	23	29	.025

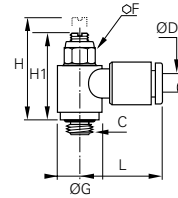
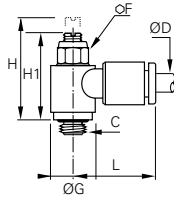

7625 Knobless Mini Meter Out Flow Control Fractional Inch Tube to NPT

PART NO. METER OUT	ØD IN	C NPT	F MM	G IN	H IN	H1 IN	L IN	W OZ
7625 53 11	1/8	1/8	6	.45	.85	.71	.71	.25
7625 04 11	5/32	1/8	6	.45	.85	.71	.71	.37
7625 56 11	1/4	1/8	6	.45	.85	.71	.73	1.98
7625 56 14	1/4	1/4	6	.53	.97	.83	.73	3.23

7620 Knobless Mini Meter Out Flow Control Fractional Inch Tube to UNF

PART NO. METER OUT	ØD IN	C UNF	F MM	G IN	H IN	H1 IN	L IN	W OZ
7620 53 20	1/8	10-32	6	.35	.79	.65	.65	.18
7620 04 20	5/32	10-32	6	.35	.79	.65	.65	.18
7620 56 20	1/4	10-32	6	.35	.79	.65	.65	.20

WARNING These products can expose you to chemicals including NICKEL, CARBON BLACK, TITANIUM DIOXIDE, or LEAD, which are known to the state of

Swivel Outlet Flow Controls



Parker's swivel outlet flow controls are designed to allow a vertical or angled tube exit where access is restricted.

Product Features:

- Glass reinforced nylon 6.6 body
- Stainless steel gripping ring
- Nickel-plated brass adjustment screw
- Nickel-plated brass locking nut
- Nickel-plated brass threads
- Nitrile D seal
- NPT, BSPT, BSPP, Metric threads

Markets:

- Factory/Process Automation
- Life Science
- Food Processing
- Water And Beverage
- Petrochemical

Applications:

- Packaging
- Filling
- Dispensing
- Bottling
- Pneumatic Circuits

Specifications:

Pressure Range 15 to 145 psi (1.0 to 9.9 bar)

Temperature Range +30° to +160° F (-1.1 to +71.1° C)

Compatible Tubing:

- Semi-rigid nylon
- Polyurethane 95 Durometer Shore A
- Nylon
- Fluoropolymer

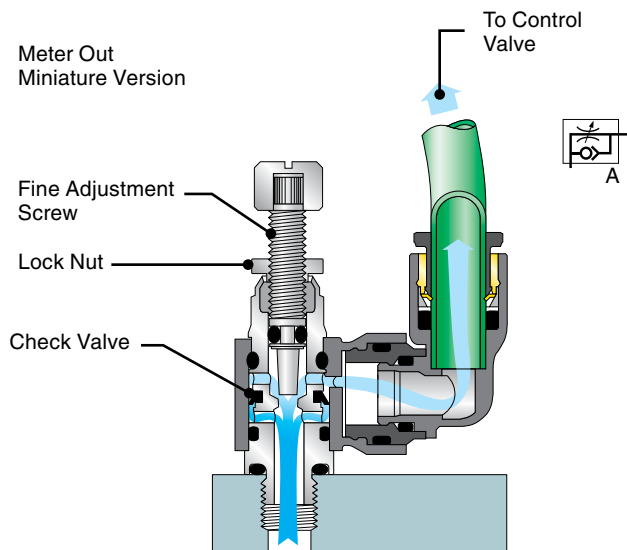

Assembly Instructions

1. Cut tubing squarely – maximum of 15° angle allowable.
2. Check that port or mating part is clean and free of debris.
3. Mark tubing to appropriate tube insertion length. (see Tube Insertion Chart on page N22)
4. Insert tubing until it bottoms
5. Pull on tubing to verify it is fully inserted
6. To disassemble, simply press release button, hold against body and pull tubing out of fitting.

Click here for CADs, Product Specifications or to Configure Parts Online

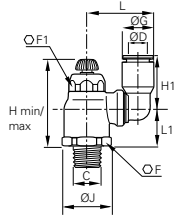

7045 Compact Swivel Outlet Flow Control Tube to NPT or BSPT

PART NO. METER OUT	C NPT	ØD IN	F MM	F1 MM	G IN	H MIN IN	H MAX IN	H1 IN	H2 IN	L IN	L1 IN	W OZ
7045 56 11	1/8	1/4	19	10	.41	1.87	2.09	.63	.83	.93	.65	.91
7045 56 14	1/4	1/4	19	14	.43	1.79	1.99	.73	.83	1.00	.89	.91
7045 60 14	1/4	3/8	23	17	.63	1.93	2.20	1.04	.98	1.34	.97	2.19
7045 60 18	3/8	3/8	23	17	.63	1.93	2.20	1.04	.98	1.34	.97	2.29

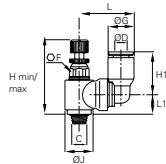

7640/7645 Miniature Swivel Outlet Flow Control Tube to NPT, UNF, or BSPT

PART NO. METER OUT	C UNF/ NPT	ØD IN	F MM	G IN	H MIN IN	H MAX IN	H1 IN	J IN	L IN	L1 IN	W OZ
7640 04 20	10-32	5/32	6	.33	.96	1.08	.55	.37	.73	.26	.39
7645 04 11	1/8	5/32	8	.33	1.08	1.20	.55	.45	.73	.33	.39

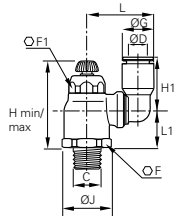

7040/7041 Compact Swivel Outlet Flow Control Metric Tube to BSPP or M5

PART NO. METER OUT	PART NO. METER IN	C BSPP	ØD MM	F MM	F1 MM	G MM	H MIN MM	H MAX MM	H1 MM	J MM	L MM	L1 MM	W KG
7040 06 10	-	G1/8	6	16	10	10.5	38	44	16	17.5	23.5	18	.026
7040 06 13	-	G1/4	6	16	10	10.5	36.5	42.5	16	17.5	23.5	16.5	.029
7040 08 10	7041 08 10	G1/8	8	19	14	13.5	41.5	48	23	21	28	19	.035
7040 08 13	-	G1/4	8	19	14	13.5	41.5	48	23	21	28	19.5	.039
7040 08 17	-	G3/8	8	19	14	13.5	41.5	48	23	22	28	17.5	.043
7040 10 13	-	G1/4	10	23	17	16	45.5	53.5	26.5	25	35	21	.051
7040 10 17	-	G3/8	10	23	17	16	45.5	54	26.5	25	35	21.5	.063
7040 12 17	-	G3/8	12	23	17	19	45.5	54	31	25	38	21.5	.066
7040 12 21	-	G1/2	12	24	17	19	45.5	54	31	26	38	21	.071

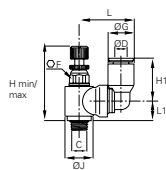

7640/7649 Miniature Swivel Outlet Metric Tube to BSPP or M5

PART NO. METER OUT	PART NO. METER IN	C BSPP/ M5	ØD MM	F MM	G MM	H MM	H MIN MM	H MAX MM	J MM	L MM	L1 MM	W KG
7640 04 19	7649 04 19	M5X0.8	4	6	8.5	24.5	27.5	14.5	9.5	19.5	6.5	.011
7640 04 10	-	G1/8	4	7	8.5	27.5	31	14.5	11.5	20	8.5	.015
7640 06 19	7649 06 19	M5X0.8	6	6	10.5	24.5	27.5	16	9.5	21.5	6.5	.013
7640 06 10	7649 06 10	G1/8	6	7	10.5	27.5	31	16	11.5	22	8.5	.015

WARNING These products can expose you to chemicals including NICKEL, CARBON BLACK, TITANIUM DIOXIDE, or LEAD, which are known to the state of

Plug-In Flow Controls



Parker's Plug-in flow controls can be directly mounted into existing fittings and allow very compact installations. They are particularly suited for mounting in manifolds using cartridges.

Product Features:

- Glass reinforced nylon 6.6 body
- Stainless steel gripping ring
- Nickel-plated brass adjustment screw
- Nickel-plated brass locking nut
- Nickel-plated tailpiece
- Nitrile D seal

Markets:

- Factory/Process Automation
- Life Science
- Food Processing
- Water And Beverage
- Petrochemical

Applications:

- Packaging
- Filling
- Dispensing
- Bottling
- Pneumatic Circuits

Specifications:

Pressure Range 15 to 145 psi (1.0 to 9.9 bar)

Temperature Range +30° to +160° F (-1.1 to +71.1° C)

Compatible Tubing:

- Semi-rigid nylon
- Polyurethane 95 Durometer Shore A
- Nylon
- Fluoropolymer

Miniature

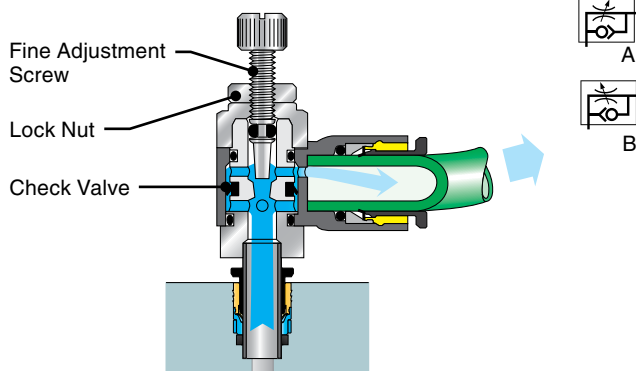

Compact

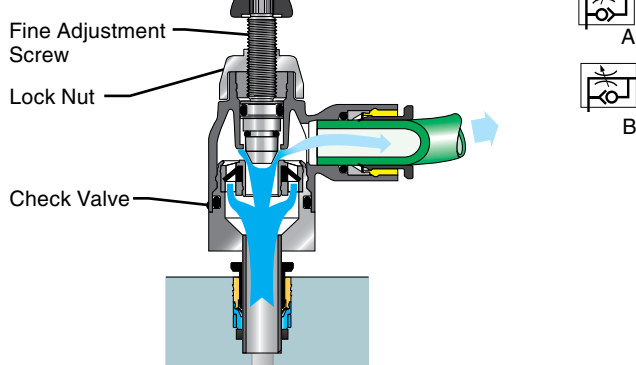

Assembly Instructions

1. Cut tubing squarely – maximum of 15° angle allowable.
2. Check that port or mating part is clean and free of debris.
3. Mark tubing to appropriate tube insertion length. (see Tube Insertion Chart on page N22)
4. Insert tubing until it bottoms
5. Pull on tubing to verify it is fully inserted
6. To disassemble, simply press release button, hold against body and pull tubing out of fitting.

Click here for CADs, Product Specifications or to Configure Parts Online

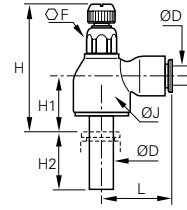
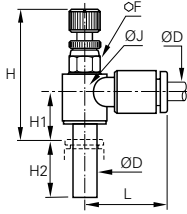

7630/7631 Plug-In Miniature Flow Control Fractional Inch Tube

PART NO. METER OUT	PART NO. METER IN	ØD IN	F MM	H MIN IN	H MAX IN	H1 IN	H2 IN	L IN	W OZ
7630 53 00		1/8	6	.94	1.04	.12	.59	.67	.25
7630 04 00	7631 04 00	5/32	6	1.00	1.10	.37	.61	.67	.25
7630 56 00	7631 56 00	1/4	7	1.08	1.18	.12	.73	.73	.39

7030/7031 Plug-In Compact Flow Control Metric Tube

PART NO. METER OUT	PART NO. METER IN	ØD MM	F MM	H MIN MM	H MAX MM	H1 MM	H2 MM	J MM	L MM	W KG
7030 06 00	7031 06 00	6	10	35	41	14	17	16	22	.019
7030 08 00	7031 08 00	8	14	39.5	46.5	16	21.5	19	28	.035
7030 12 00	-	12	17	43	51	17	27	23	31.5	.060

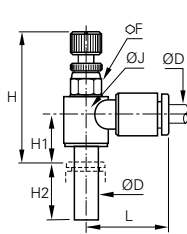

7630/7631 Plug-In Miniature Flow Control Metric Tube

PART NO. METER OUT	PART NO. METER IN	ØD MM	F MM	H MIN MM	H MAX MM	H1 MM	H2 MM	J MM	L MM	W KG
7630 04 00	7631 04 00	4	6	25.5	28	9.5	15.5	9	17	.007
7630 06 00	7631 06 00	6	7	27.5	29	10.5	17	11.5	18.5	.011

WARNING These products can expose you to chemicals including NICKEL, CARBON BLACK, TITANIUM DIOXIDE, or LEAD, which are known to the state of

In-Line Flow Controls



Parker's In-Line flow controls are unidirectional. An arrow on the body indicates the direction of controlled flow. They can be used individually or stacked together using joining clips.

Product Features:

- Glass reinforced nylon 6.6 body
- Stainless steel gripping ring
- Nickel-plated brass adjustment screw
- Nickel-plated brass locking nut
- Nickel-plated threads
- Nitrile D seal
- Panel mountable

Markets:

- Factory/Process Automation
- Life Science
- Food Processing
- Water And Beverage
- Petrochemical

Applications:

- Packaging
- Filling
- Dispensing
- Bottling
- Pneumatic Circuits

Specifications:

Pressure Range 15 to 145 psi (1.0 to 9.9 bar)

Temperature Range +30° to +160° F (-1.1 to +71.1° C)

Compatible Tubing:

- Semi-rigid nylon
- Polyurethane 95 Durometer Shore A
- Nylon
- Fluoropolymer

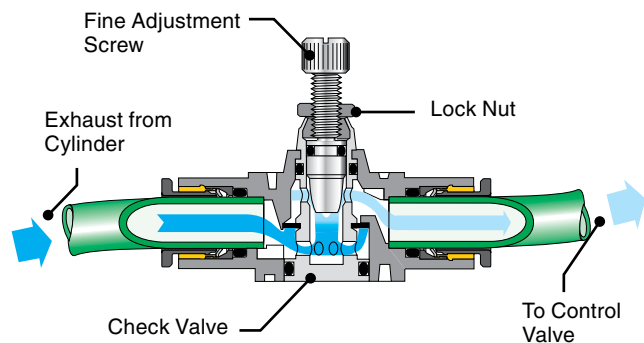

Assembly Instructions

1. Cut tubing squarely – maximum of 15° angle allowable.
2. Check that port or mating part is clean and free of debris.
3. Mark tubing to appropriate tube insertion length. (see Tube Insertion Chart on page N22)
4. Insert tubing until it bottoms
5. Pull on tubing to verify it is fully inserted
6. To disassemble, simply press release button, hold against body and pull tubing out of fitting.

Click here for CADs, Product Specifications or to Configure Parts Online

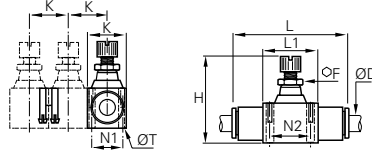

7770 In-Line Flow Control Fractional Inch

PART NO. ONE-WAY	PART NO. BI-DIRECTIONAL	ØD IN	DIN MIN	F MM	H MIN MM	H MAX MM	K IN	L IN	L1 IN	N1 IN	N2 IN	ØT IN	W OZ
7770 04 00	7772 04 00	5/32	.12	5	1.15	1.31	.47	1.41	.59	.31	.43	.09	.32
7770 56 00	7772 56 00	1/4	.16	8	1.54	1.74	.66	2.00	.90	.43	.66	.12	1.06
7770 08 00	7772 08 00	5/16	.24	11	1.73	1.97	.73	2.38	1.02	.49	.79	.13	1.66
7770 60 00	–	3/8	.31	14	2.03	2.38	.94	2.87	1.29	.62	1.01	.16	4.06
7770 62 00	–	1/2	.39	14	2.24	2.63	1.09	3.35	1.37	.78	1.07	.16	5.56

7772 In-Line Flow Control Metric Tube

PART NO. ONE-WAY	PART NO. BI-DIRECTIONAL	ØD MM	DIN MIN	F MM	H MIN MM	H MAX MM	K MM	L MM	L1 MM	N1 MM	N2 MM	ØT MM	W KG
7770 04 00	7772 04 00	4	3	5	29.5	33.5	12	15	12	8	11	2.2	.009
7770 06 00	7772 06 00	6	4	8	40.5	44.5	17	51	23	11	17	3.2	.024
7770 08 00	7772 08 00	8	6	11	44	50	60.5	26	18.5	12.5	20	3.2	.047
7770 10 00	–	10	8	14	52	61	76	33	24	16	26	4.2	.103
7770 12 00	–	12	10	14	57.5	67.5	86	35	28	20	27.5	4.2	.138

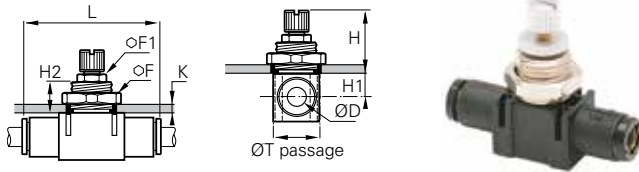

7776 In-Line Panel Mountable Flow Control Metric Tube

PART NO. ONE-WAY	ØD MM	F MM	F1 MM	H MIN MM	H MAX MM	L MM	W KG
7776 04 00*	4	14	–	21.5	25.5	36	.015
7776 06 00*	6	19	–	27.5	32.5	51	.038
7776 08 00	8	24	11	28.5	34.5	60.5	.047
7776 10 00	10	30	14	29.5	38.5	76	.103
7776 12 00	12	32	14	32	42	86	.138

7000 Joining Clips For In-Line Flow Controls and Mini Ball Valves*

PART NO.	ØD IN	ØD MM	W OZ
7000 00 05	5/32	4	.14
7000 00 05	1/4	6	.14
7000 00 05	5/16	8	.14
7000 00 06	3/8	10	.32
7000 00 06	1/2	12	.32

* Two clips are supplied with flow control. Order additional clips using the part numbers above.

Fixing Dimensions

PART NO. ONE-WAY	ØD MM	K MAX MM	H1 MM	H2 MM	ØT MM
7776 04 00*	4	6	6.5	11	10.5
7776 06 00*	6	7	7.5	13.5	16.5
7776 08 00	8	7	9	13.5	18.5
7776 10 00	10	7	11.5	13.5	24.5
7776 12 00	12	8	12.5	15.5	27.5

*ultrafine adjustment

WARNING These products can expose you to chemicals including NICKEL, CARBON BLACK, TITANIUM DIOXIDE, or LEAD, which are known to the state of

[Click here for CADs, Product Specifications or to Configure Parts Online](#)

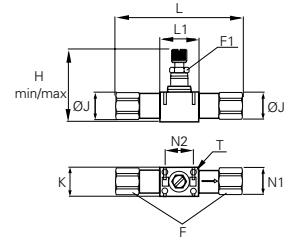

7775 Threaded In-Line Flow Control NPT

PART NO.	NPT	F MM	F1 MM	H MIN MM	H MAX MM	J IN	L IN	L1 IN	K IN	N1 IN	N2 IN	ØT IN	W OZ
7775 11 11	1/8	13	8	1.56	1.75	.55	2.70	.91	.67	.43	.67	.12	.55
7775 14 14	1/4	16	11	1.73	1.97	.69	3.27	1.02	.73	.49	.79	.12	1.20
7775 18 18	3/8	22	14	2.05	2.40	.94	3.82	1.30	.94	.63	1.02	.16	4.61
7775 22 22	1/2	24	14	2.26	2.66	1.02	4.76	1.38	1.10	.79	1.08	.16	5.58

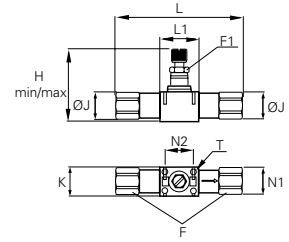

7771 Threaded In-Line Flow Control BSPP

PART NO.	BSPP	F MM	F1 MM	H MIN MM	H MAX MM	J MM	L MM	L1 MM	K MM	N1 MM	N2 MM	ØT MM	W KG
7771 10 10	G1/8	13	8	39.5	44.5	14	68.5	23	17	11	17	3.2	.043
7771 13 13	G1/4	16	11	44	50	17.5	83	26	18.5	12.5	20	3.2	.103
7771 17 17	G3/8	19	14	52	61	21	97	33	24	16	26	4.2	.160
7771 21 21	G1/2	24	14	57.5	67.5	26	121	35	28	20	27.5	4.2	.247

⚠️ WARNING: These products can expose you to chemicals including NICKEL, CARBON BLACK, TITANIUM DIOXIDE, or LEAD, which are known to the state of

Metal Flow Controls



Parker's Metal flow controls are suited for use in severe conditions (temperatures, sparks, abrasion, etc.). Adjustment can be made with a screwdriver and locking by use of a wrench.

Product Features:

- Treated brass body
- Stainless steel gripping ring
- Electroless-nickel-plated brass adjustment screw
- Nickel-plated brass locking nut
- Nickel-plated threads
- Nitrile D seal

Markets:

- Factory/Process Automation
- Petrochemical
- Automotive Process

Applications:

- Robotics
- Packaging
- Textile

Specifications:

Pressure Range 15 to 145 psi (1.0 to 9.9 bar)

Temperature Range +30° to +160° F (-1.1 to +71.1° C)

Compatible Tubing:

- Semi-rigid nylon
- Polyurethane 95 Durometer Shore A
- Nylon
- Fluoropolymer

Meter Out Version

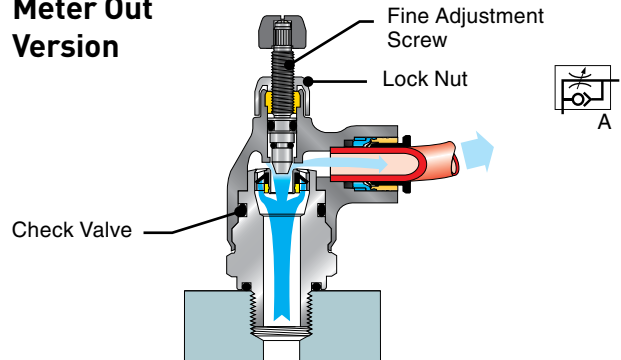

Meter In Version

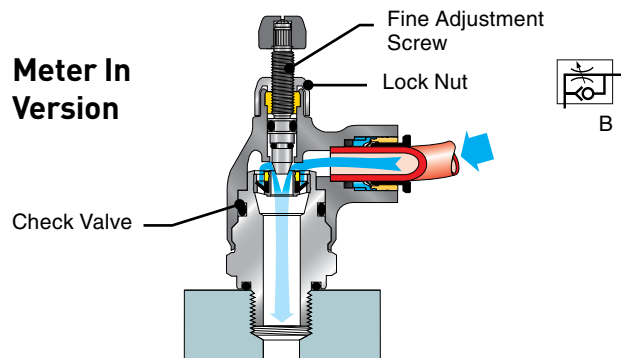

Assembly Instructions

1. Cut tubing squarely – maximum of 15° angle allowable.
2. Check that port or mating part is clean and free of debris.
3. Mark tubing to appropriate tube insertion length. (see Tube Insertion Chart on page N22)
4. Insert tubing until it bottoms
5. Pull on tubing to verify it is fully inserted
6. To disassemble, simply press release button, hold against body and pull tubing out of fitting.

[Click here for CADs, Product Specifications or to Configure Parts Online](#)

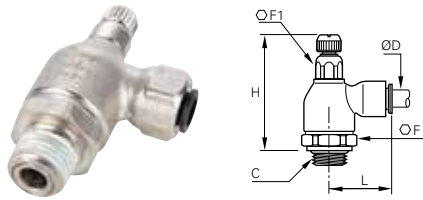

7105 Push-To-Connect Meter Out Metal Flow Control Fractional Inch Tube to NPT

PART NO. METER OUT	ØD IN	C NPT	F MM	F2 MM	H MIN IN	H MAX IN	L IN	W OZ
7105 56 11	1/4	1/8	19	10	1.79	2.01	.97	2.82
7105 56 14	1/4	1/4	19	10	1.79	2.01	.97	2.92
7105 60 14	3/8	1/4	19	14	1.91	2.11	1.14	3.80
7105 60 18	3/8	3/8	25	17	2.15	2.40	1.40	3.90

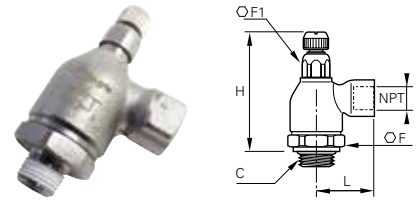

7115 Threaded Port Meter Out Metal Flow Control NPT

PART NO. METER OUT	C NPT	F MM	F1 MM	H MIN IN	H MAX IN	L IN	W OZ
7115 11 11	1/8	19	10	1.79	2.01	.89	2.75
7115 14 14	1/4	19	14	1.91	2.11	1.28	3.90
7115 18 18	3/8	25	17	2.15	2.40	1.36	7.25
7115 22 22	1/2	25	17	2.15	2.40	1.50	7.64

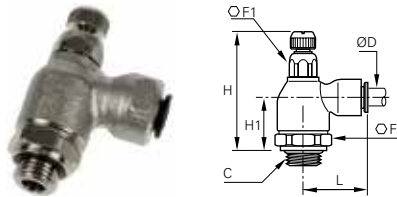

7100/7101 Push-To-Connect Metal Flow Control Metric Tube to BSPP

PART NO. METER OUT	PART NO. METER IN	ØD MM	C BSPP	F MM	F1 MM	H MIN MM	H MAX MM	H1 MM	L MM	W KG
7100 04 10	7101 04 10	4	G1/8	10	19	47	53	23	21	.076
7100 06 10	7101 06 10	6	G1/8	10	19	47	53	23	24.5	.077
7100 06 13	7101 06 13	6	G1/4	10	19	47.5	53	23.5	24.5	.080
7100 08 10	7101 08 10	8	G1/8	14	19	50	55	24.5	29	.090
7100 08 13	7101 08 13	8	G1/4	14	19	50	56	25	29	.101
7100 08 17	7101 08 17	8	G3/8	17	25	56	62	27	30.5	.121
7100 10 13	-	10	G1/4	14	19	50	56	25	35	.140
7100 10 17	-	10	G3/8	17	25	56	62	27	35	.161
7100 12 17	-	12	G3/8	17	25	56	62	27	38	.181
7100 12 21	-	12	G1/2	17	25	55	62	27	38	.203
7100 14 21	-	14	G1/2	17	25	55	62	27	41	.201

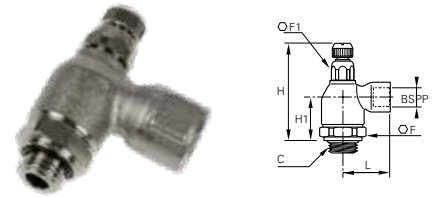

7110/7111 Threaded Port Metal Flow Control BSPP

PART NO. METER OUT	PART NO. METER IN	C BSPP	F MM	F1 MM	H MIN MM	H MAX MM	H1 MM	L MM	W KG
7110 10 10	7111 10 10	G1/8	10	19	47	52.5	23	22.5	.076
7110 13 13	7111 13 13	G1/4	14	19	50.5	55.5	25	32	.107
7110 17 17	-	G3/8	17	25	56	62	27	34.5	.212
7110 21 21	-	G1/2	17	25	55	62	27	37.5	.194

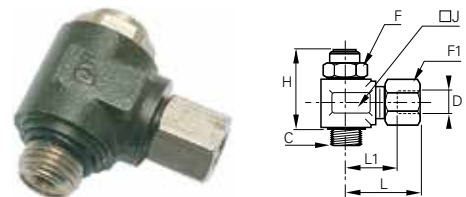

7160 Compression Knobless Meter Out Metal Flow Control Metric Tube to BSPP

PART NO.	ØD MM	C BSPP	F MM	F1 MM	H MM	J MM	L MM	L1 MM	W KG
7160 04 10	4	G1/8	13	10	26	17	25.5	14.5	.050
7160 06 10	6	G1/8	13	13	26	17	25.5	14.5	.054
7160 08 10	8	G1/8	13	14	26	17	29.5	15.5	.054
7160 08 13	8	G1/4	17	14	31.5	22	31	17	.109
7160 10 13	10	G1/4	17	19	31.5	22	35	19	.119
7160 10 17	10	G3/8	20	19	44.5	22	37.5	19	.186
7160 10 21	10	G1/2	23	19	50	27	37.5	19	.201
7160 12 21	12	G1/2	23	22	50	34	38	21.5	.212

WARNING: These products can expose you to chemicals including NICKEL, CARBON BLACK, TITANIUM DIOXIDE, or LEAD, which are known to the state of

Stainless Steel Flow Controls



Parker's Stainless Steel Flow Controls are used to regulate the speed of a cylinder rod as well as flow in environments with high mechanical or chemical constraints.

Product Features:

- Suitable for corrosive environments
- Excellent mechanical and chemical resistance
- 100% leak tested in production
- Smooth external surfaces to facilitate cleaning
- Suitable for food applications

Markets:

- Factory/Process Automation
- Life Science
- Food Processing
- Water And Beverage
- Petrochemical

Applications:

- Packaging
- Filling
- Dispensing
- Bottling,
- Pneumatic Circuits
- Semi-Conductors

Specifications:

Pressure Range 15 to 145 psi (1.0 to 9.9 bar)

Temperature Range +30° to +160° F (-1.1 to +71.1° C)

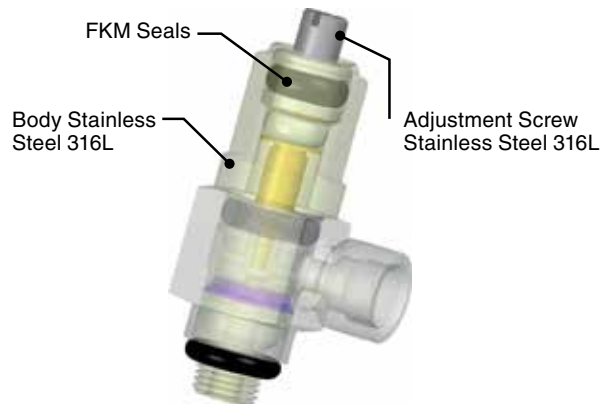

Assembly Instructions

1. Cut tubing squarely – maximum of 15° angle allowable.
2. Check that port or mating part is clean and free of debris.
3. Mark tubing to appropriate tube insertion length. (see Tube Insertion Chart on page N22)
4. Insert tubing until it bottoms
5. Pull on tubing to verify it is fully inserted
6. To disassemble, simply press release button, hold against body and pull tubing out of fitting.

Operation

Exhaust Model with External Adjustment

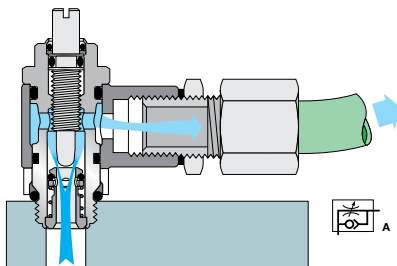

Bi-Directional Model with External Adjustment

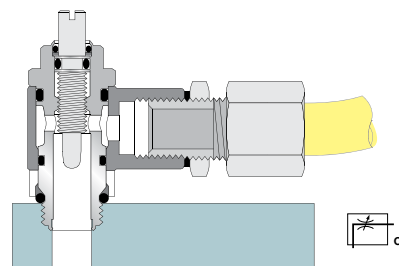

[Click here for CADs, Product Specifications or to Configure Parts Online](#)

7810/7815/7812/7817 Threaded Port Knobless Stainless Steel Flow Control NPT/UNF

PART NO. METER OUT	PART NO. BI-DIRECTIONAL	C UNF/NPT	E IN	E1 IN	F MM	H IN	J IN	L IN	W OZ
7810 20 20	7812 20 20	10-32	.16	.16	8	.94	.35	.43	.95
7815 11 11	7817 11 11	1/8	.20	.31	13	1.50	.59	.67	1.23
7815 14 14	-	1/4	.31	.47	17	1.38	.71	.94	1.69

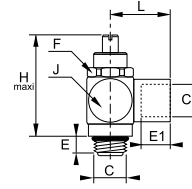

7810/7812 Threaded Port Knobless Stainless Steel Flow Control BSPP/Metric

PART NO. METER OUT	PART NO. BI-DIRECTIONAL	C BSPP	E MM	F MM	G MM	H MM	L1 MM	L2 MM	W KG
7810 19 19	7812 19 19	M5X0.8	4	4	8	24	10	11	.027
7810 10 10	7812 10 10	G1/8	5	8	13	38	15	17	.035
7810 13 13	7812 13 13	G1/4	8	12	17	40	18	24	.048
7810 17 17	7812 17 17	G3/8	7	12	20	53	22	24	.059
7810 21 21	7812 21 21	G1/2	8	15	23	69	28	31	.076

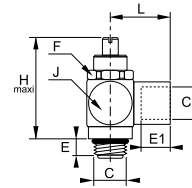

7835 Push-To-Connect Knobless Stainless Steel Flow Control Fractional Inch Tube to NPT

PART NO. METER OUT	ØD IN	C NPT	F MM	H IN	J IN	L IN	W OZ
7835 56 11	1/4	1/8	13	1.30	.59	.87	1.69
7835 60 18	3/8	3/8	20	1.89	.87	1.26	2.68

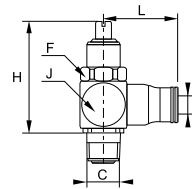

WARNING These products can expose you to chemicals including NICKEL, CARBON BLACK, TITANIUM DIOXIDE, or LEAD, which are known to the state of

In-Line Check Valves



Parker's In-Line Check Valves allows air to pass in one direction while blocking flow in the other direction. The body of the fitting contains an arrow to indicate the direction of flow.

Product Features:

- Nylon/Nickel-plated brass body
- VC – Acetal body
- Stainless steel gripping ring
- Nickel-plated brass threads
- Nitrile O-ring
- EPDM O-ring (VC)

Markets:

- Factory/Process Automation
- Packaging
- Petrochemical
- Pneumatics
- Semi-Conductor

Applications:

- Robotics
- Packaging
- Textile
- Machine Tools
- Pneumatic Systems
- Vacuum

Specifications:

Pressure Range	15 to 145 psi (1.0 to 9.9 bar)
Temperature Range	+34° to +150° F (+1.1° to 65.5° C)
Cracking Pressure	PLCK – 7 PSI (0.4 bar), VC – 1/3 PSI (0.02 bar)

Compatible Tubing:

- Semi-rigid nylon
- Polyurethane 95 Durometer Shore A
- Nylon
- Fluoropolymer

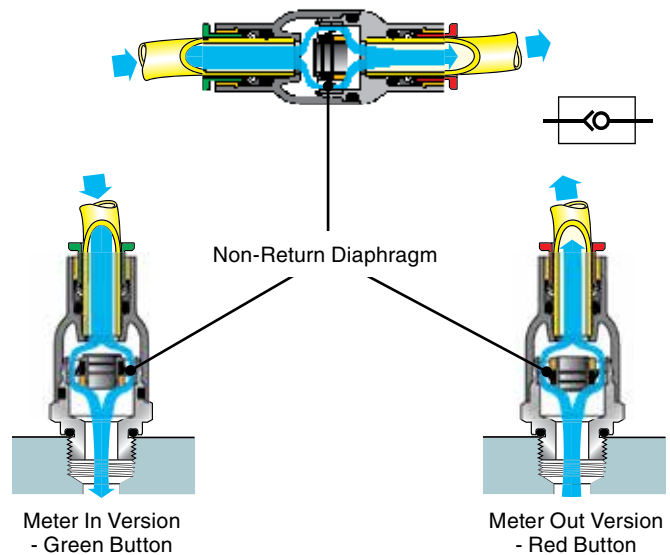

Assembly Instructions

1. Cut tubing squarely – maximum of 15° angle allowable.
2. Check that port or mating part is clean and free of debris.
3. Mark tubing to appropriate tube insertion length. (see Tube Insertion Chart on page N22)
4. Insert tubing until it bottoms
5. Pull on tubing to verify it is fully inserted
6. To disassemble, simply press release button, hold against body and pull tubing out of fitting.

[Click here for CADs, Product Specifications or to Configure Parts Online](#)

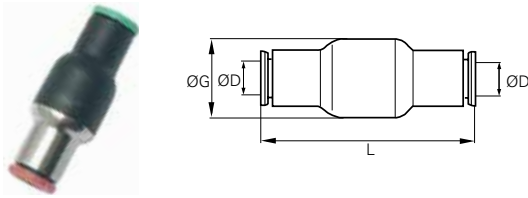

7996 In-Line Check Valve Tube to Tube

PART NO. FRACTIONAL INCH TUBE	ØD IN	G IN	L IN	W OZ
7996 04 00	5/32	.63	1.52	.28
7996 56 00	1/4	.63	1.61	.51
7996 08 00	5/16	.75	2.03	.63
7996 60 00	3/8	.91	2.50	.63

PART NO. METRIC TUBE	ØD MM	G MM	L MM	W KG
7996 04 00	4	16	38.5	.008
7996 06 00	6	16	41	.013
7996 08 00	8	19	51.5	.018
7996 10 00	10	23	63.5	.018
7996 12 00	12	23	66.5	.018



7994/7995/7984/7985 Male Check Valve Fractional Inch Tube to NPT or UNF

PART NO. METER OUT	PART NO. METER IN	ØD IN	C NPT/UNF	F MM	H IN	W OZ
7994 04 20	7984 04 20	5/32	10-32	9	1.26	.28
7995 04 11	7985 04 11	5/32	1/8	16	1.12	.28
7995 56 11	7985 56 11	1/4	1/8	19	1.42	.51
7995 56 14	7985 56 14	1/4	1/4	19	1.42	.51
7995 60 14	7985 60 14	3/8	1/4	23	1.65	.63
7995 60 18	7985 60 18	3/8	3/8	23	1.65	.63



7995/7985 Male Check Valve Metric Tube to BSPT

PART NO. METER OUT	PART NO. METER IN	ØD MM	C BSPT	F MM	H MM	W OZ
7995 04 10	7985 04 10	4	R1/8	16	28.5	.016
7995 06 10	7985 06 10	6	R1/8	16	30.5	.016
7995 06 13	7985 06 13	6	R1/4	16	30.5	.021
7995 08 10	7985 08 10	8	R1/8	19	36	.022
7995 08 13	7985 08 13	8	R1/4	19	36	.026
7995 10 17	-	10	R3/8	23	42	.027
7995 12 17	7985 12 17	12	R3/8	23	42	.029
7995 12 21	7985 12 21	12	R1/2	23	44	.034



7994/7984 Male Check Valve Metric Tube to BSPP

PART NO. METER OUT	PART NO. METER IN	ØD MM	C BSPP	E MM	F MM	H MM	W KG
7994 04 19	7984 04 19	4	M5	3	9	32	.023
7994 04 10	7984 04 10	4	G1/8	5	16	28.5	.015
7994 06 10	7984 06 10	6	G1/8	5	16	30.5	.015
7994 06 13	7984 06 13	6	G1/4	5.5	16	30.5	.015
7994 08 10	7984 08 10	8	G1/8	5	19	36	.021
7994 08 13	7984 08 13	8	G1/4	5.5	19	36	.023
7994 12 17	-	12	G3/8	5.5	23	42	.029
7994 12 21	-	12	G1/2	7.5	23	44	.034

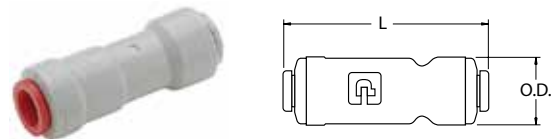

VC Check Valve Fractional Inch Tube to Tube

PART NO.	ØD IN	L IN	ØD IN	W OZ
A4VC4-MG	1/4	2.00	.66	.02
A5VC5-MG	5/16	2.10	.70	.03
A6VC6-MG	3/8	2.15	.80	.03
A8VC8-MG	1/2	2.68	.91	.06

WARNING These products can expose you to chemicals including NICKEL, CARBON BLACK, TITANIUM DIOXIDE, or LEAD, which are known to the state of



Stainless Steel Check Valves

Parker's Stainless Steel Check Valves are ideally suited to harsh environments and for conveying industrial fluids. These check valves allow fluids to flow in one direction and prevent them from flowing in the other.

Product Features:

- 316L Stainless Steel Body & Poppet
- 302 Stainless Steel Spring
- FKM Seals
- Smooth external surfaces contribute to equipment cleanliness
- Suitable for use in corrosive environments

Markets:

- Factory/Process Automation
- Life Science
- Food Processing
- Water And Beverage
- Petrochemical

Applications:

- Pneumatics
- Machine Tools
- Processing
- Chemical
- Printing

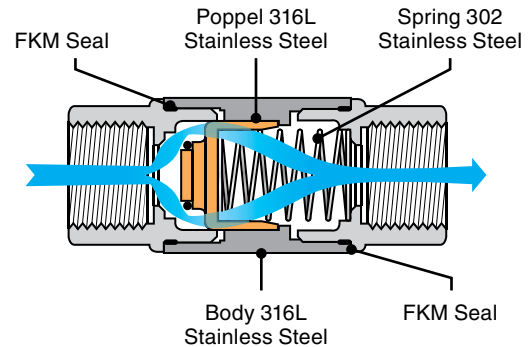

Specifications:

Pressure Range 7 to 580 PSI (0.4 to 39.9 bar)

Cracking Pressure 3.6 PSI (0.2 bar)

Temperature Range -4° to +356° F (-20° to +180° C)

Flow Characteristics

MODEL	WATER FLOW AT 90 PSI	KV
1/8	.67 SCFM	1.60
1/4	.70 SCFM	1.69
3/8	1.26 SCFM	3.01
1/2	1.29 SCFM	3.10
3/4	2.33 SCFM	5.59
1	3.27 SCFM	7.86

[Click here for CADs, Product Specifications or to Configure Parts Online](#)

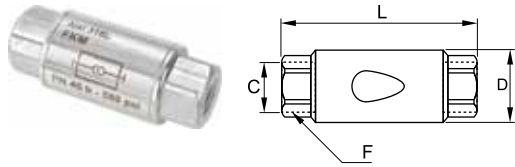

4890 Unidirectional Female - BSPP

PART NO.	C	DN	D MM	F MM	L MM
4890 10 10	G1/8	10	22	17	50
4890 13 13	G1/4	10	22	17	50
4890 17 17	G3/8	15	30	22	67
4890 21 21	G1/2	15	30	25	71
4890 27 27	G3/4	20	42	32	84
4890 34 34	G1	25	42	38	90

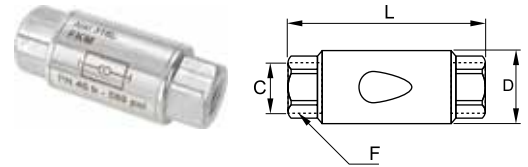

4895 Unidirectional Female - NPT

PART NO.	C	DN	D MM	F MM	L MM
4895 11 11	1/8	10	22	18	50
4895 14 14	1/4	10	22	18	54
4895 18 18	3/8	15	30	22	73
4895 22 22	1/2	15	30	25	77

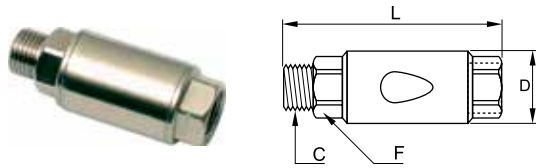

4891 Unidirectional Male to Female - BSPP

PART NO.	C	DN	D MM	F MM	L MM
4891 10 10	G1/8	10	22	17	56
4891 13 13	G1/4	10	22	17	58
4891 17 17	G3/8	15	30	22	75
4891 21 21	G1/2	15	30	25	79
4891 27 27	G3/4	20	42	32	98
4891 34 34	G1	25	42	38	104

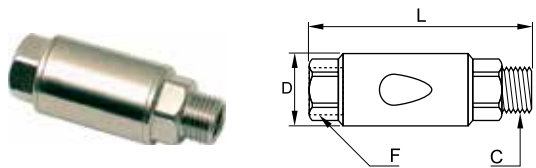

4892 Unidirectional Female to Male - BSPP

PART NO.	C	DN	D MM	F MM	L MM
4892 10 10	G1/8	10	22	17	56
4892 13 13	G1/4	10	22	17	58
4892 17 17	G3/8	15	30	22	75
4892 21 21	G1/2	15	30	25	79
4892 27 27	G3/4	20	42	32	98
4892 34 34	G1	25	42	38	104

WARNING These products can expose you to chemicals including NICKEL, CARBON BLACK, TITANIUM DIOXIDE, or LEAD, which are known to the state of



Pilot Operated Check Valves

Parker's Pilot Operated Check Valves are designed to protect installations. If the compressed air supply is removed they lock the air supply to the cylinder, maintaining it in position.

Product Features:

- Orientable and adjustable through 3 axis
- Can be integrated into any installation configuration
- Vent saves time on restart after maintenance operations
- Multi-purpose fitting
 - Piloted non-return valve
 - Flow control regulator
 - Manual exhaust

Markets:

- Factory/Process Automation
- Food Processing
- Pneumatics
- Automotive

Applications:

- Pneumatics
- Machine Tools
- Processing
- Packaging
- Assembly

Specifications:

Pressure Range 14 to 145 PSI (0.9 to 9.9 bar)

Cracking Pressure 4.3 PSI (0.2 bar)

Temperature Range +23° to +140° F (-5° to 60° C)

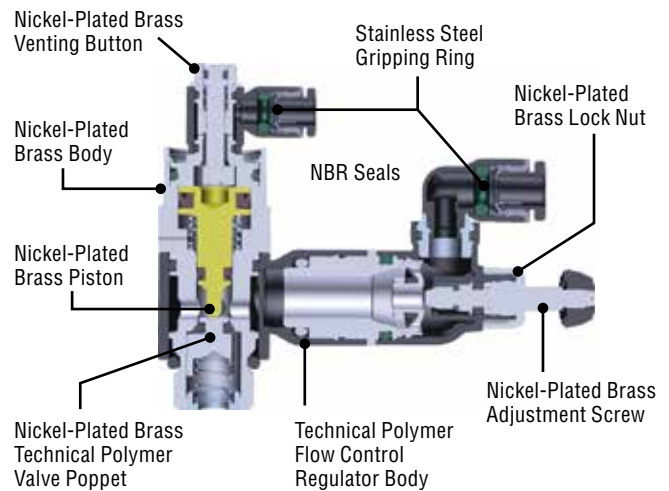

Assembly Instructions

1. Cut tubing squarely – maximum of 15° angle allowable.
2. Check that port or mating part is clean and free of debris.
3. Mark tubing to appropriate tube insertion length. (see Tube Insertion Chart on page N22)
4. Insert tubing until it bottoms
5. Pull on tubing to verify it is fully inserted
6. To disassemble, simply press release button, hold against body and pull tubing out of fitting.

Operation

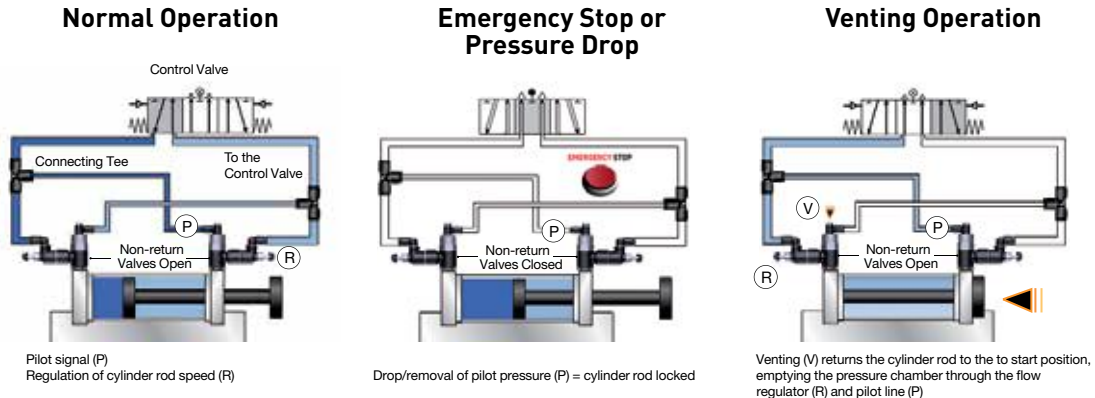

7892 Piloted Non-Return Valve - BSPP

PART NO.	D MM	C	E MM	F MM	G MM	H MM	H1 MM	H2 MM	L MM
7892 06 10	6	G1/8	6	13	14	42	30	7	21
7892 06 13	6	G1/4	9	17	18.5	45	32	9	23
7892 08 10	8	G1/8	6	13	14	42	29	9	25
7892 08 13	8	G1/4	9	17	18.5	45	32	9	27
7892 08 17	8	G3/8	6	20	22.5	57	41	11	28
7892 10 17	10	G3/8	6	20	22.5	57	41	11	31
7892 10 21	10	G1/2	10	24	28	63	47	16	36
7892 12 21	12	G1/2	10	24	28	63	47	16	36

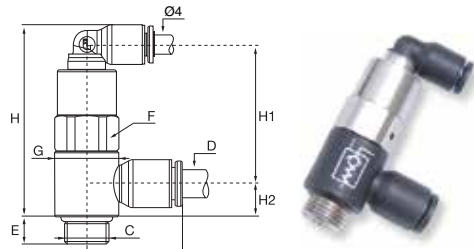

7894 Piloted Non-Return Valve with Flow Regulator and Exhaust - BSPP

PART NO.	D MM	C	E MM	F1 MM	F2 MM	G MM	H MM	H1 MM	H2 MM	H3 MM	L MIN	L MAX	L MM
7894 06 10	6	G1/8	6	13	8	14	46	7	24	31	48.5	51	16
7894 06 13	6	G1/4	9	17	10	18.5	49	11	18	31	59.5	65	17
7894 08 10	8	G1/8	6	13	8	14	46	7	27	31	48.5	51	22
7894 08 13	8	G1/4	9	17	10	18.5	49	11	23	31	59.5	65	23
7894 08 17	8	G3/8	6	20	14	22.5	69	13	21	40	67.5	73	23
7894 10 17	10	G3/8	6	20	14	22.5	69	13	29	40	67.5	73	26
7894 10 21	10	G1/2	10	24	17	28	76	12.5	26	47	74	81	26
7894 12 21	12	G1/2	10	24	17	28	76	12.5	27	47	74	81	30

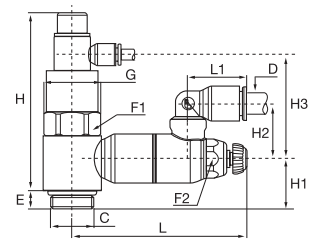

WARNING: These products can expose you to chemicals including NICKEL, CARBON BLACK, TITANIUM DIOXIDE, or LEAD, which are known to the state of California to cause cancer or reproductive harm. For more information, go to www.P65Warnings.ca.gov.



Pneumatic Slide Valves

Parker's Slide Valves may be used to effect an immediate isolation of the air line by venting the system to atmosphere. By moving the sleeve in one direction, the air is free to pass through the slide valve to the system. By moving it in the opposite direction, the supply is shut off and the downstream air is allowed to exhaust to the atmosphere.

Product Features:

- Lightweight due to use of aluminum
- Nitrile Seals
- Immediate identification of the venting system by the color (red)
- Uni-directional use ensures the downstream circuit is vented
- Operated in the plane of the tube

Markets:

- Factory/Process Automation
- Food Processing
- Packaging

Applications:

- Pneumatics
- Conveyors
- Packaging
- Textile
- Plastics Engineering

Specifications:

Pressure Range Up to 230 PSI (15.8 bar)

Temperature Range +15° to +175° F (-9.4° to +79.4° C)

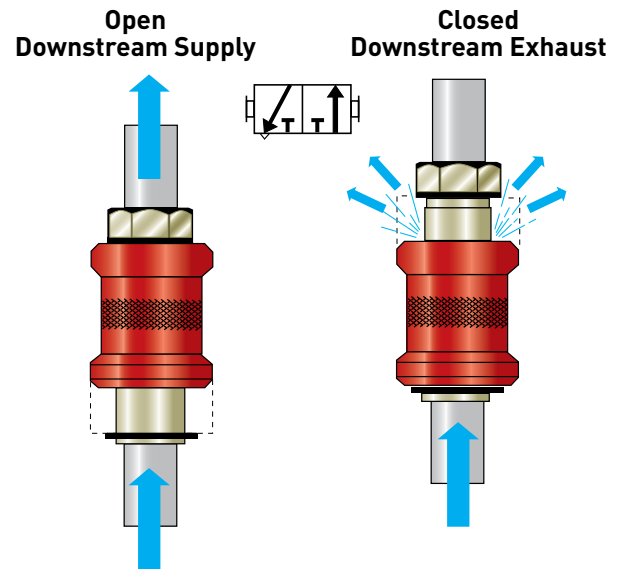

[Click here for CADs, Product Specifications or to Configure Parts Online](#)

Principle of Operation

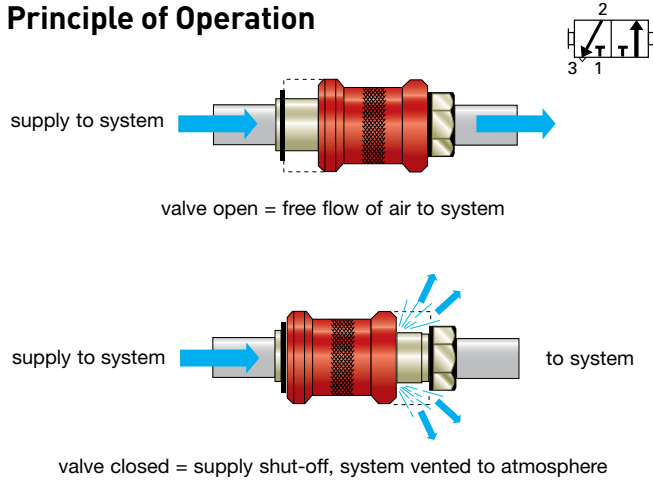

Parker Legris' pneumatic slide valves may be used to effect an immediate isolation of the air line by venting the system to atmosphere. By moving the sleeve in one direction, the air is free to pass through the slide valve to the system. By moving it in the opposite direction, the supply is shut off and the downstream air is allowed to exhaust to the atmosphere. The design is compact, neat, aesthetic and can be directly installed in the circuit.

Suitable Fluid	compressed air
Direction of Medium	one way
Maximum Working Pressure	230 psi (16 bar)
Working Temperature	15° to 175° F (-9° to 79° C)
Materials of Construction	sleeve: anodized aluminum body: nickel-plated brass seals: nitrile rubber

0661 Male/Female Slide Valves NPT

PART NO.	C NPT	DN	F IN	G IN	L IN	W OZ
0661 04 11	1/8	.16	.55	.98	2.19	2.47
0661 07 14	1/4	.27	.67	1.18	2.75	4.59
0661 10 18	3/8	.39	.87	1.38	3.21	7.59
0661 14 22	1/2	.55	1.06	1.57	3.75	11.30

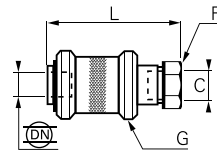

0660 Double Female Slide Valve NPT

PART NO.	C NPT	DN	F IN	G IN	L IN	W OZ
0660 04 11	1/8	.16	.55	.98	1.89	2.12
0660 07 14	1/4	.27	.67	1.18	2.28	3.71
0660 10 18	3/8	.39	.87	1.38	2.68	6.18
0660 14 22	1/2	.55	1.06	1.57	3.15	9.53

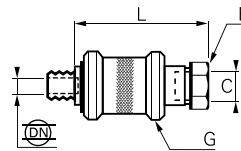

0669 Double Female Slide Valve BSPP

PART NO.	C BSPP/M5	DN	F MM	G MM	L MM	W KG
0669 02 19	M5X0.8	2	10	14	30.5	.045
0669 04 10	G1/8	4	14	25	48	.051
0669 07 13	G1/4	7	19	30	58	.084
0669 10 17	G3/8	10	22	35	68	.153
0669 14 21	G1/2	14	27	40	80	.227
0669 19 27	G3/4	19	32	50	83	.242

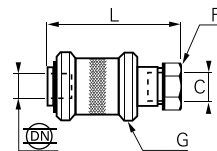

WARNING These products can expose you to chemicals including NICKEL, CARBON BLACK, TITANIUM DIOXIDE, or LEAD, which are known to the state of

[Click here for CADs, Product Specifications or to Configure Parts Online](#)

Quick Exhaust Valve



Parker's Quick Exhaust Valve increases the return speed of the cylinder rod by allowing the exhaust to pass directly to atmosphere.

Product Features:

- Nickel plated brass body
- Nylon seal
- Polyurethane piston
- Reduction in cycle times: return speed improved
- Excellent exhaust capacity
- Ideal for applications in restrictive environments

Markets:

- Factory/Process Automation
- Packaging
- Industrial
- Pulp & Paper

Applications:

- Pneumatics
- Conveyors
- Packaging
- Textile
- Plastics Engineering

Specifications

Pressure Range 10 to 150 PSI (0.6 to 10.3 bar)

Temperature Range 0° to +160° F (-17.7 to +71.1° C)

7970 Quick Exhaust Valve Threaded Ports - BSPP

PART NO.	C BSPP	E MM	F MM	H MM	H1 MM	L MM	W OZ
7970 19 19	M5X0.8	5	10	24.8	15.6	4	.029
7970 10 10	G1/8	7.5	14	42	28	8	.084
7970 13 13	G1/4	11	19	53	34.5	11	.148
7970 17 17	G3/8	12	21	58	36	12	.153
7970 21 21	G1/2	14	26	71	44	14	.316
7970 27 27	G3/4	16	32	86	52	18	.449
7970 34 34	G1	19	38	94	56	19	.531

7982 Quick Exhaust Valve Threaded Ports - NPT

PART NO.	C NPT	F MM	H1 IN	L IN	H IN	W OZ
7982 11 11	1/8	14	1.10	.28	1.69	2.97
7982 14 14	1/4	19	1.38	.37	2.11	5.18
7982 18 18	3/8	20	1.42	.35	2.19	5.64
7982 22 22	1/2	26	1.77	.55	2.83	11.29

Operation

Mounted on Cylinder

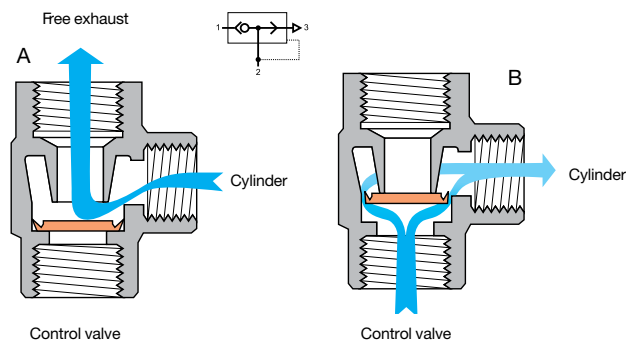

Installation Diagram

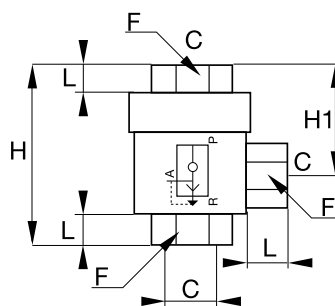
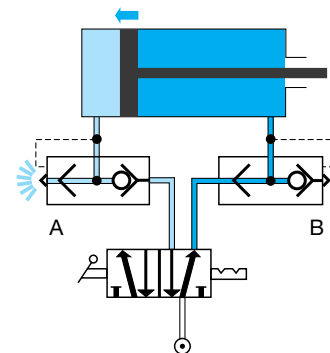

WARNING These products can expose you to chemicals including NICKEL, CARBON BLACK, TITANIUM DIOXIDE, or LEAD, which are known to the state of

Blocking Valves



Parker's Blocking Valves prevents damage to work and equipment in the event of a loss of pressure. Blocking valves which are mounted in pairs on a cylinder lock the piston by simultaneously cutting off the supply and exhaust.

Product Features:

- Treated brass body
- Stainless steel gripping ring
- Nickel-plated brass threads
- NBR seals
- Silicone free

Markets:

- Factory/Process Automation
- Packaging
- Petrochemical
- Automotive Process

Applications:

- Robotics
- Packaging
- Textile
- Machine Tools

Compatible Tubing:

- Semi-rigid nylon
- Polyurethane 95 Durometer Shore A
- Nylon
- Fluoropolymer

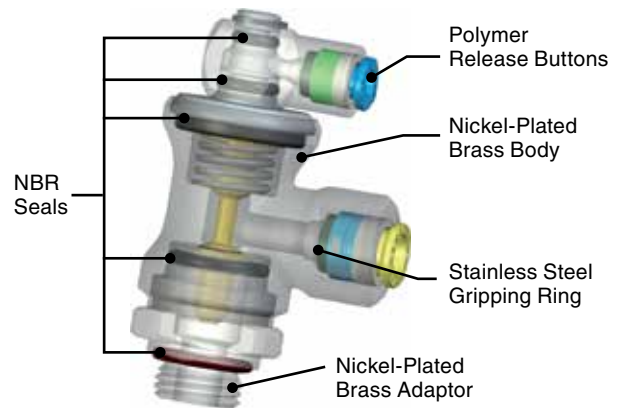

Specifications:

Pressure Range 15 to 145 PSI (1.0 to 9.9 bar)

Temperature Range -4° to +160° F (-20° to +71.1° C)

Leak Rate <3.2CCM

Number of Cycles >10 Million at 68°F and 1 HZ

Assembly Instructions

1. Cut tubing squarely – maximum of 15° angle allowable.
2. Check that port or mating part is clean and free of debris.
3. Mark tubing to appropriate tube insertion length. (see Tube Insertion Chart on page N22)
4. Insert tubing until it bottoms
5. Pull on tubing to verify it is fully inserted
6. To disassemble, simply press release button, hold against body and pull tubing out of fitting.

Operation

Cylinder in Operation (pilot signal active)

Cylinder Blocked (pilot signal removed)

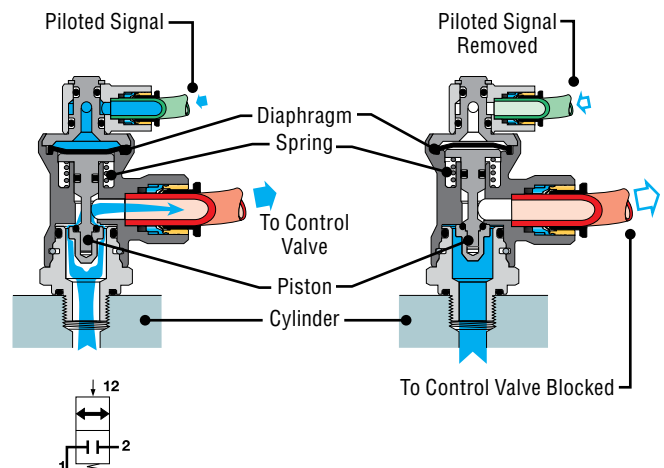

Click here for CADs, Product Specifications or to Configure Parts Online

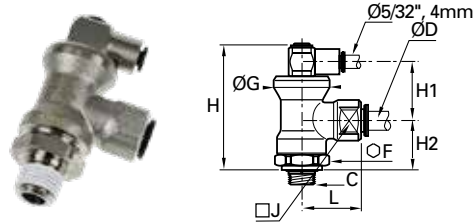

7885 Push-To-Connect Lock Out Valves Tube to NPT or BSPT

PART NO. FRACTIONAL INCH	ØD IN	C NPT	F MM	G IN	H IN	H1 IN	H2 IN	J IN	L IN	W OZ
7885 56 11	1/4	1/8	21	.95	2.03	1.24	.79	.67	1.10	6.53
7885 56 14	1/4	1/4	21	.95	2.03	1.24	.79	.67	1.10	4.77
7885 60 18	3/8	3/8	24	1.10	2.19	1.14	1.04	1.06	1.38	7.59
7885 62 22	1/2	1/2	24	1.10	2.19	1.14	1.04	1.06	1.69	18.00

PART NO. METRIC	ØD MM	C BSPT	F MM	G MM	H MM	H1 MM	H2 MM	J MM	L MM	W KG
7885 06 10	6	R1/8	21	24	51.5	31.5	20	17	28	.121
7885 06 13	6	R1/4	21	24	51.5	31.5	20	17	28	.124
7885 08 13	8	R1/4	21	24	51.5	31.5	20	17	28	.119
7885 08 17	8	R3/8	21	24	51.5	31.5	20	17	28	.122
7885 10 17	10	R3/8	24	28	55.5	29	26.5	27	35	.197
7885 12 21	12	R1/2	24	28	55.5	29	26.5	27	37.5	.203

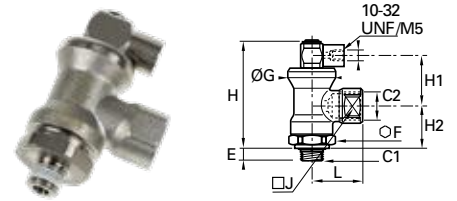

7886 Lock Out Valves – Threaded Ports NPT or BSPT

PART NO. FRACTIONAL INCH	C1 NPT	C2 NPT	E IN	F MM	G IN	H IN	H1 IN	H2 IN	J IN	L IN	W OZ
7886 11 11	1/8	1/8	.37	21	.95	2.03	1.24	.79	.67	1.04	7.24
7886 14 14	1/4	1/4	.55	21	.95	2.03	1.24	.79	.67	1.04	4.59
7886 18 18	3/8	3/8	.65	24	1.10	2.19	1.14	1.04	1.06	1.34	7.77
7886 22 22	1/2	1/2	.77	24	1.10	2.19	1.14	1.04	1.06	1.57	8.47

PART NO. METRIC	C1 BSPT	C2 BSPT	E MM	F MM	G MM	H MM	H1 MM	H2 MM	J MM	L MM	W KG
7886 13 10	R1/8	R1/4	14	21	24	51.5	31.5	20	17	26.5	.113
7886 13 13	R1/4	R1/4	14	21	24	51.5	31.5	20	17	26.5	.115
7886 17 17	R3/8	R3/8	16.5	24	28	55.5	29	26.5	27	34	.200
7886 21 21	R1/2	R1/2	19.5	24	28	55.5	29	26.5	27	40	.209

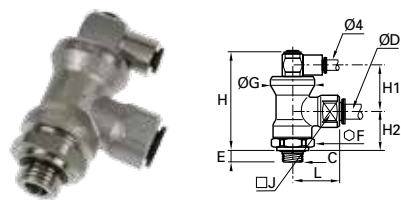

7880 Push-To-Connect Lock Out Valves Metric Tube to BSPP

PART NO.	ØD MM	C BSPP	E MM	F MM	G MM	H MM	H1 MM	H2 MM	J MM	L MM	W KG
7880 06 10	6	G1/8	5	21	24	53	24.5	21	17	28	.121
7880 06 13	6	G1/4	5.5	21	24	53	24.5	21	17	28	.124
7880 08 13	8	G1/4	5.5	21	24	53	24.5	21	17	28	.119
7880 08 17	8	G3/8	5.5	24	28	56	25	23	27	34.5	.122
7880 10 17	10	G3/8	5.5	24	28	56	25	23	27	35	.197
7880 12 21	12	G1/2	7	24	28	56	25	23	27	37.5	.203

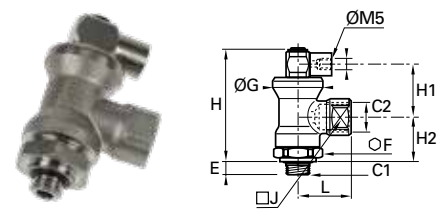

7881 Lock Out Valves – Threaded Ports BSPP

PART NO.	C1 BSPP	C2 BSPP	E MM	F MM	G MM	H MM	H1 MM	H2 MM	J MM	L MM	W KG
7881 13 10	G1/8	G1/4	5	21	24	53	24.5	21	17	28	.113
7881 13 13	G1/4	G1/4	5.5	21	24	53	24.5	21	17	28	.115
7881 17 17	G3/8	G3/8	5.5	24	28	56	25	23	27	34	.200
7881 21 21	G1/2	G1/2	7	24	28	56	25	23	27	41	.209

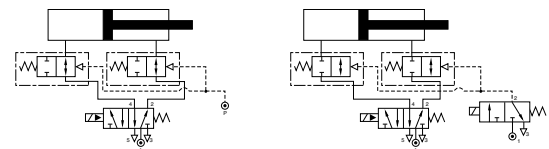

Typical Applications

- Parker Legris lock-out valves incorporated into a 5/2 valve.
 - The compressed air maintains the lock-out valves in their normal position where air can easily pass through exactly like a normal fitting.
 - In the event of compressed air failure, the springs at both the lock-out valves will close the double-acting cylinder ports (2 & 4) thereby preventing downward movement.
 - Only with the recovery of compressed air will the lock-out valves allow normal flow and operation.
- With the introduction of a 3/2 way valve more interesting variations can be achieved for specific applications.
 - With a normally open valve, the lock-out valves will assume their closed positions when the pilot signal is lost. A typical application is a fail safe mode or with the introduction of a signal like an emergency signal.

WARNING These products can expose you to chemicals including NICKEL, CARBON BLACK, TITANIUM DIOXIDE, or LEAD, which are known to the state of

Threshold Sensor Fittings



Parker's Threshold Sensor Fitting detects the pressure drop when a cylinder reaches the end of its stroke. They produce a pneumatic or electrical output signal when the pressure drop in the exhaust chamber of the cylinder goes below their back pressure threshold.

Product Features:

- Polymer body
- Brass screw
- NBR seal

Markets:

- Factory/Process Automation
- Packaging
- Pneumatics
- Semi-Conductor

Applications:

- Robotics
- Packaging
- Textile
- Machine Tools
- Pneumatic Systems

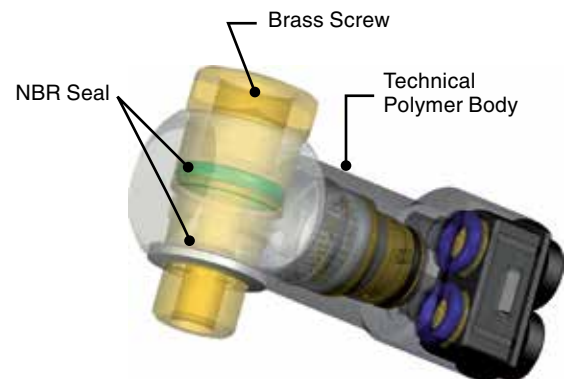

Specifications:

Model PSBJ, PSPJ

Pressure Range 45 to 115 PSI (3.1 to 7.9 bar)

Temperature Range +5° to +140° F (-15° to +60° C)

Breaking Pressure 8.5 PSI (0.5 bar)

Response Time 3 MS

Model PSPE

Pressure Range 45 to 115 PSI (3.1 to 7.9 bar)

Breaking Pressure 8.5 PSI (0.5 bar)

Current Rating 5A/250VAC – 5W/48VDC

Compatible Tubing:

- Semi-rigid nylon
- Polyurethane 95 Durometer Shore A
- Nylon
- Fluoropolymer

Operation

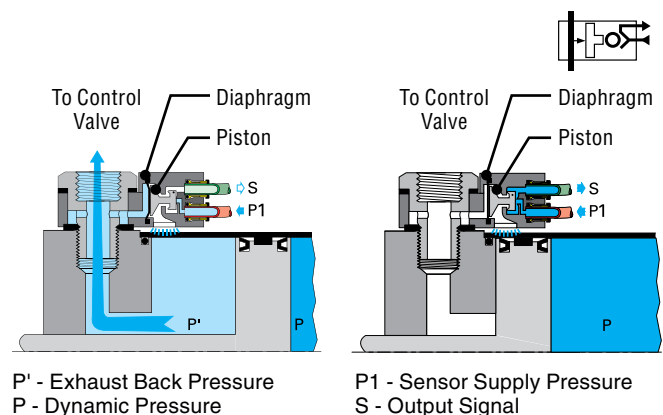

Click here for CADs, Product Specifications or to Configure Parts Online

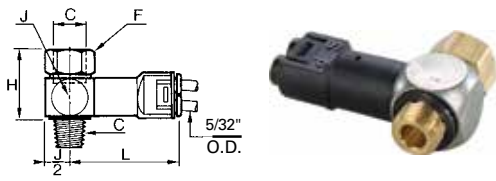

7808 Pneumatic Threshold Sensor 5/32 Tube Pilot/Signal Ports to NPT or UNF

PART NO.	C NPT /UNF	ORIFICE	F MM	F1 MM	H MIN MM	H MAX MM	W OZ
7818 04 20*	10-32	.08	5/16	.62	.43	1.70	.88
7808 04 11	1/8	.20	9/16	.90	.62	1.74	1.55
7808 04 14	1/4	.27	5/8	1.09	.76	1.81	2.51
7808 04 18	3/8	.39	7/8	1.13	.92	1.91	3.25
7808 04 22	1/2	.55	1	1.17	1.23	2.05	5.47

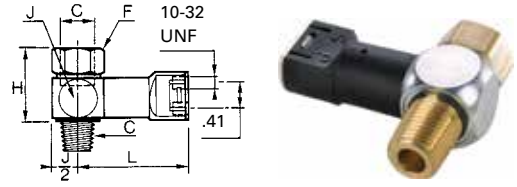

7808 Pneumatic Threshold Sensor 10-32 UNF Pilot/Signal Ports to NPT

PART NO.	C NPT	ORIFICE	F IN	H IN	J IN	L IN	W OZ
7808 20 11	1/8	.20	9/16	.90	.62	1.58	1.66
7808 20 14	1/4	.27	5/8	1.09	.76	1.66	2.61
7808 20 18	3/8	.39	7/8	1.13	.92	1.76	3.46

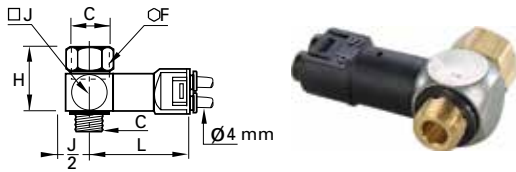

7818 Pneumatic Threshold Sensor 4mm Tube Pilot/Signal Ports to BSPP or M5

PART NO.	C BSPP/ M5	DN MIN	F MM	H MM	J MM	L MM	W KG
7818 04 19*	M5X0.8	2	8	16	11	43.5	.025
7818 04 10	G1/8	5	14	23	16	44.5	.082
7818 04 13	G1/4	7	17	28	19.5	46.5	.113
7818 04 17	G3/8	10	22	29	23.5	49	.128
7818 04 21	G1/2	14	27	30	31.5	52.5	.159

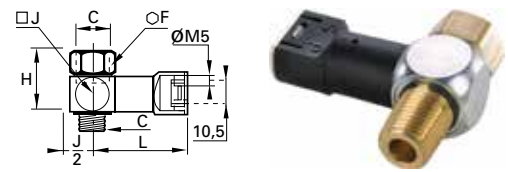

7818 Pneumatic Threshold Sensor M5 Pilot/Signal Ports to BSPP

PART NO.	C BSPP	DN MIN	F MM	H MM	J MM	L MM	W KG
7818 19 10	G1/8	5	14	23	16	40.5	.087
7818 19 13	G1/4	7	17	28	19.5	42.5	.117

WARNING: These products can expose you to chemicals including NICKEL, CARBON BLACK, TITANIUM DIOXIDE, or LEAD, which are known to the state of

[Click here for CADs, Product Specifications or to Configure Parts Online](#)

Assembly on Cylinder

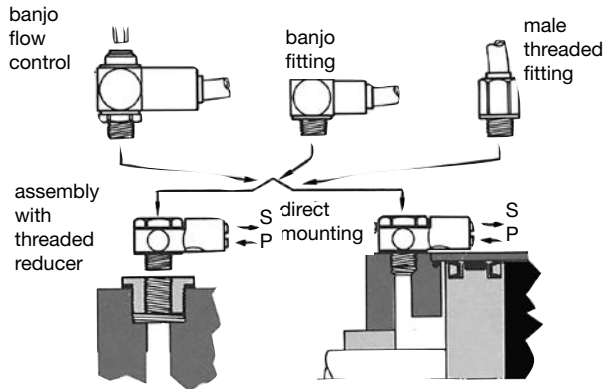

Installation

The threshold sensor can be mounted on the cylinder, on the control valve or on a terminal block provided it is between the cylinder and the flow control. For accuracy, the flow control is mounted as close as possible to the cylinder. It can be fitted to a sensor fitting mounted on the cylinder.

Technical Specifications for Pneumatic/Electric Threshold Sensor Valves

Threshold Signal Pressure	7 psi
Current Rating	5A/250VAC - 5W/48VDC
UL Listed Component Reset Pressure	10 psi
Electrical Connection	cable: three core, 2 meters (6.5 ft) long BLACK (NC) BLUE (COMM) BROWN (NO)

Pneumatic/Electric Sensors

Exhaust pressure is sensed by a N/O, N/C contact relay switch.

Pneumatic/Electric Threshold valves are ideally suited to turn on or off a light, or to send an electric signal to another function in the system. They are supplied with a 6 ft., three core cable and can be used with AC or DC voltages.

Advantages for the user:

- small size
- replaces traditional sequence valves and/or limit switches
- eliminates on going normal adjustment associated with limit valves

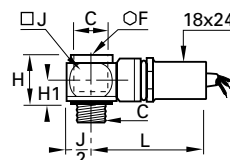
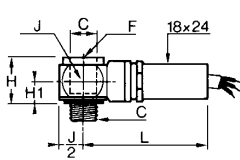

7828/7829 Pneumatic/Electric Threshold Sensor NPT or UNF

PART NO.	C NPT/UNF	F MM	H IN	H1 IN	J IN	L IN	W OZ
7828 00 20	10-32	8	.79	.39	.43	1.93	5.30
7829 00 11	1/8	6	.79	.39	.63	2.05	6.10
7829 00 14	1/4	8	.79	.39	.83	2.13	6.35
7829 00 18	3/8	10	.87	.47	1.10	2.24	7.50
7829 00 22	1/2	12	1.02	.55	1.30	2.28	9.35

7828 Pneumatic/Electric Threshold Sensor BSP or M5

PART NO.	C BSP/M5	F MM	H MM	H1 MM	J MM	L MM	W KG
7828 00 19	M5X0.8	8	20	10	11	49	.115
7828 00 10	G1/8	6	20	10	16	52	.120
7828 00 13	G1/4	8	20	10	21	54	.125
7828 00 17	G3/8	10	22	12	28	57	.150

WARNING: These products can expose you to chemicals including NICKEL, CARBON BLACK, TITANIUM DIOXIDE, or LEAD, which are known to the state of California to cause cancer and birth defects or other reproductive harm.

Mini Ball Valves



Parker's Mini Ball Valves enable in-line opening and closing of a pneumatic circuit. Handles are color coded and marked with the corresponding pneumatic symbol, in order to enable immediate identification by the user.

Product Features:

- Nylon body
- Brass stem
- Stainless steel gripping ring
- NBR stem seal
- NBR o-ring
- Nylon Handle
- Lightweight and compact

Markets:

- Factory/Process Automation
- Packaging
- Petrochemical
- Pneumatics
- Semi-Conductor

Applications:

- Robotics
- Packaging
- Textile
- Machine Tools
- Pneumatic Systems
- Vacuum

Specifications:

Pressure Range	145 PSI (9.9 bar)
Temperature Range	-4° to 175° F (-20° to +79.4° C)
Vacuum Capability	28" Hg

Compatible Tubing:

- Semi-rigid nylon
- Polyurethane 95 Durometer Shore A
- Nylon
- Fluoropolymer

Operation

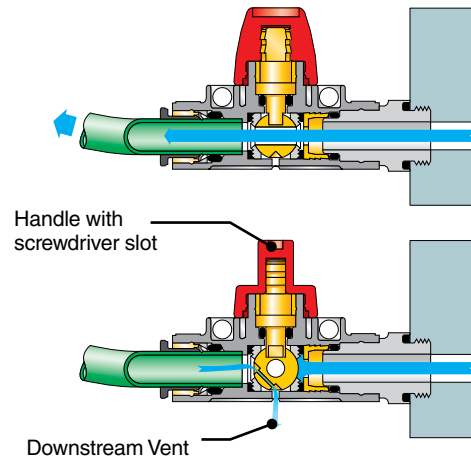

[Click here for CADs, Product Specifications or to Configure Parts Online](#)

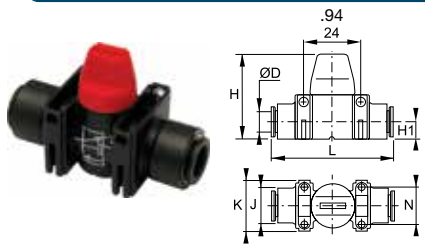

7913 – 3/2 Vented with Push-to-Connect Ports

PART NO.	ØD IN	H IN	H1 IN	J IN	K IN	L IN	N IN	W OZ
7913 04 00	5/32	1.46	.30	.59	.87	2.0	.64	.78
7913 56 00	1/4	1.46	.30	.59	.87	2.0	.64	1.45
7913 08 00	5/16	1.46	.30	.59	.87	2.0	.64	1.98
7913 60 00	3/8	1.69	.43	.79	1.18	2.6	.87	4.06

PART NO.	ØD MM	H MM	H1 MM	J MM	K MM	L MM	N MM	W KG
7913 04 00	4	37	7.5	15	22	51	16.2	0.022
7913 06 00	6	37	7.5	15	22	52	16.2	0.041
7913 08 00	8	37	7.5	15	22	52	16.2	0.056
7913 10 00	10	43	11	20	30	66	22	0.115
7913 12 00	12	43	11	20	30	66	22	0.147



7910 – 2/2 with Push-to-Connect Ports

PART NO.	ØD IN	H IN	H1 IN	J IN	K IN	L IN	N IN	W OZ
7910 04 00	5/32	1.46	.30	.59	.87	2.01	.64	.74
7910 56 00	1/4	1.46	.30	.59	.87	2.05	.64	1.41
7910 08 00	5/16	1.46	.30	.59	.87	2.05	.64	1.94
7910 60 00	3/8	1.69	.43	.79	1.18	2.60	.64	3.95

PART NO.	ØD MM	H MM	H1 MM	J MM	K MM	L MM	N MM	W KG
7910 04 00	4	37	7.5	15	22	51	16.2	0.021
7910 06 00	6	37	7.5	15	22	52	16.2	0.040
7910 08 00	8	37	7.5	15	22	52	16.2	0.055
7910 10 00	10	43	11	20	30	66	16.2	0.112
7910 12 00	12	43	11	20	30	66	16.2	0.144

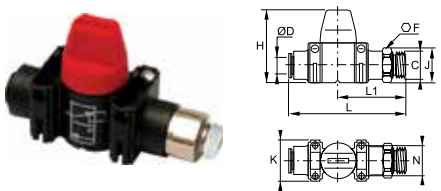

7915 – 3/2 Vented with Male Thread and Push-to-Connect Port NPT

PART NO.	ØD IN	C NPT	F MM	H IN	J IN	K IN	L IN	L1 IN	N IN	W OZ
7915 04 11	5/32	1/8	13	1.46	.55	.87	2.44	1.46	.64	1.76
7915 56 11	1/4	1/8	13	1.46	.55	.87	2.44	1.46	.64	1.90
7915 56 14	1/4	1/4	14	1.46	.59	.87	2.44	1.38	.64	2.40
7915 08 14	5/16	1/4	14	1.46	.59	1.18	2.40	1.61	.64	2.40
7915 08 18	5/16	3/8	18	1.46	.77	1.18	2.91	1.61	.64	2.82
7915 60 14	3/8	1/4	16	1.69	.69	1.18	2.40	1.65	.87	3.60
7915 60 18	3/8	3/8	18	1.69	.77	1.18	2.91	1.65	.87	4.94

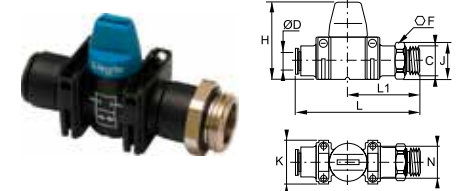

7911 – 2/2 with Male Thread and Push-to-Connect Port BSPP

PART NO.	ØD MM	C BSPP	F MM	H MM	J MM	K MM	L MM	L1 MM	N MM	W KG
7911 06 10	6	G1/8	13	37	14	22	62	37	16.2	0.052
7911 08 13	8	G1/4	16	37	17.5	22	61	35	16.2	0.066
7911 10 17	10	G3/8	20	43	22	30	74	41	16.2	0.098
7911 12 21	12	G1/2	24	43	26	30	75	42	16.2	0.129

To join the mini ball valves together, use the joining clips (7000 series).

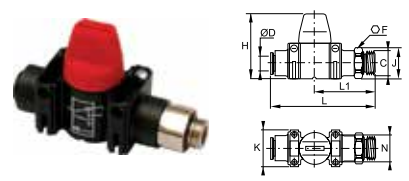

7914 – 3/2 Vented with Male Thread and Push-to-Connect Port BSPP

PART NO.	ØD MM	C BSPP	F MM	H MM	J MM	K MM	L MM	L1 MM	N MM	W KG
7914 06 10	6	G1/8	13	37	14	22	62	37	16.2	0.054
7914 08 13	8	G1/4	16	37	17.5	22	61	35	16.2	0.068
7914 10 17	10	G3/8	20	43	22	30	74	41	22	0.102
7914 12 21	12	G1/2	24	43	26	30	75	42	22	0.140

WARNING These products can expose you to chemicals including NICKEL or LEAD, which are known to the state of California to cause cancer.

Pressure Regulators



Parker Legris' pressure regulators stabilise at the maximum determined value the pressure delivered to the pneumatic equipment, whatever the fluctuations of the pressure upstream.

Product Features:

- Silicone-Free

Ergonomics

- Easy adjustment of the output pressure through the knurled screw
- Lockable adjustment possible
- Output pressure adjustment options marked on the screw

Energy Savings

- Setting of the optimum pressure enables the equipment to function correctly
- Installation in a manifold allows optimum output pressures to be delivered to specific parts of the circuit
- Designed for applications where cylinder force needs to be controlled: marking, sleeving, crimping cylinders etc.

Markets:

- Factory/Process Automation
- Packaging
- Petrochemical
- Pneumatics

Applications:

- Robotics
- Packaging
- Textile
- Semi-Conductor
- Pneumatic Systems

Specifications:

Compatible Fluids	Compressed air			
Working Pressure	Upstream pressure:	14.5 to 232 psi (1 to 16 bar)		
	Downstream pressure:	14.5 to 116 psi (1 to 8 bar)		
Working Temperature	14° to 158° F (-10° to 70° C)			

MAX. TIGHTENING TORQUES	THREADS	1/8	1/4	3/8
		IN. LB	35	40



Operation

Mounting Upstream of the Control Valve

Adjustment of the piston feed pressure in both directions

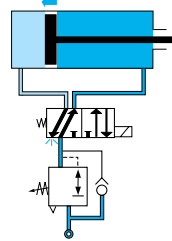

Mounting Downstream of the Control Valve

Phase 1: adjustment of the piston speed in a single direction

Phase 2: in return direction, pressure is supplied through the control valve

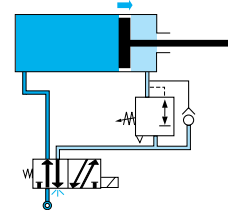
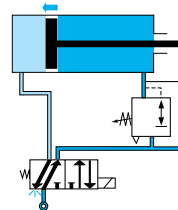

[Click here for CADs, Product Specifications or to Configure Parts Online](#)

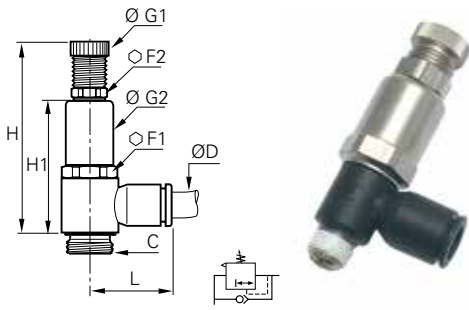

**7305 Threaded Pressure Regulator
Fractional Inch Tube to NPT**

PART NO.	ØD IN	C NPT	F1 M	F2 MM	G1 IN	G2 IN	H MIN IN	H MAX IN	H1 IN	L IN	W OZ
7305 56 14	1/4	1/4	17	13	.55	.67	2.38	3.05	1.95	.89	1.73
7305 60 14	3/8	1/4	17	13	.55	.67	2.38	3.05	1.95	1.14	2.47

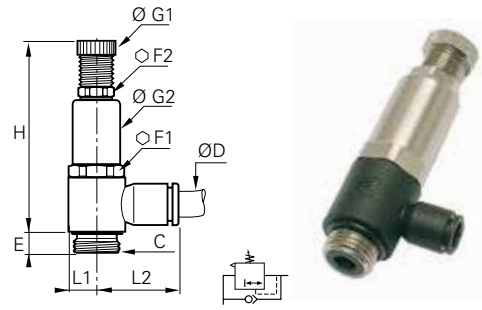

**7300 Threaded Pressure Regulator
Metric Tube to BSPP**

PART NO.	ØD MM	C BSPP	E MM	F1 MM	F2 MM	G1 MM	G2 MM	H MAX MM	L1 MM	L2 MM	W KG
7300 04 10	4	G1/8	4.5	17	13	14	18.5	60.5	7	18.5	.038
7300 06 10	6	G1/8	4.5	17	13	14	18.5	60.5	7	20	.040
7300 06 13	6	G1/4	7.5	17	13	14	18.5	68.5	9.5	22	.049
7300 08 10	8	G1/8	4.5	17	13	14	18.5	60.5	7	25	.057
7300 08 13	8	G1/4	7.5	17	13	14	18.5	68.5	9.5	27	.060
7300 08 17	8	G3/8	8.5	22	17	18.5	23.5	77.5	11.5	28.5	.064
7300 10 13	10	G1/4	7.5	17	13	14	18.5	68.5	9.5	29	.070
7300 10 17	10	G3/8	8.5	22	17	18.5	23.5	77.5	11.5	30.5	.073

Flow characteristics for NPT & BSPP threads

Upstream pressure = 100 psi

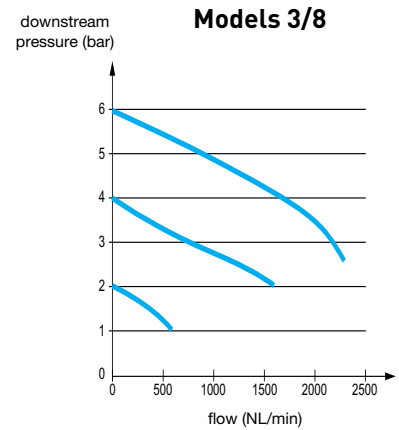
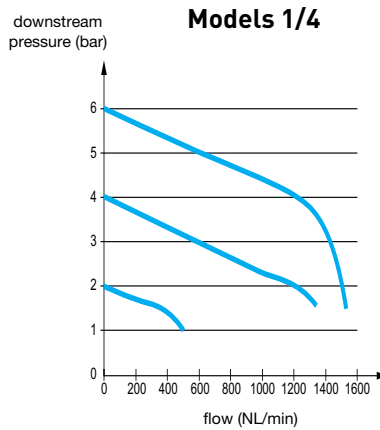
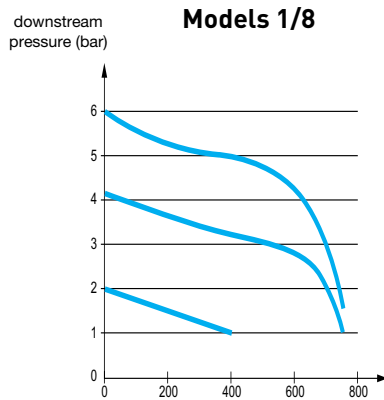

WARNING These products can expose you to chemicals including NICKEL, CARBON BLACK, TITANIUM DIOXIDE, or LEAD, which are known to the state of

Manually-Operated Valves



Parker Legris' manually-operated valves offer a reliable and durable system for opening and closing the circuit when the system has to be switched frequently. They provide a significant reduction in the time needed to work on pneumatic circuits.

Product Features:

Manual Switch-Operated Valves

- Downstream control supply provided by simply moving the lever
- 2 models available to provide the best solution for the system:
 - 3/2: opening, closing, venting
- Compact and ergonomic (can be positioned through 360°)
- Silicone-Free

Markets:

- Factory/Process Automation
- Packaging
- Industrial
- Pulp & Paper

Applications:

- Robotics
- Conveyors
- Textile
- Plastics Engineering
- Printing
- Pneumatics
- Packaging

Specifications:

Compatible Fluids	Compressed air
Working Pressure	230 psi (15.8 bar)
Working Temperature	15° to 175° F (-10° to 80° C)

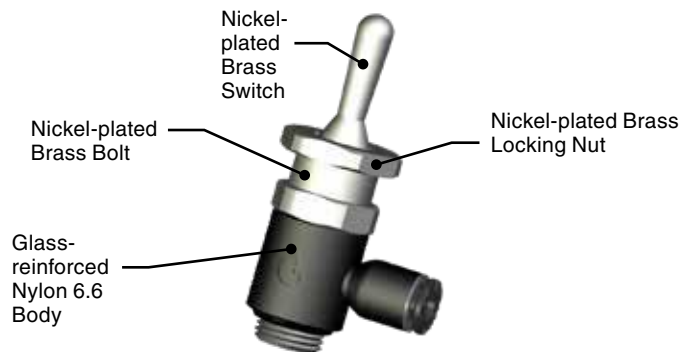

Operation

Switch-Operated Valves

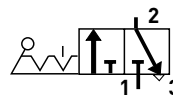

Open

Closed

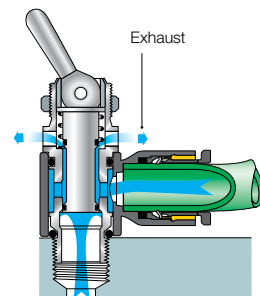
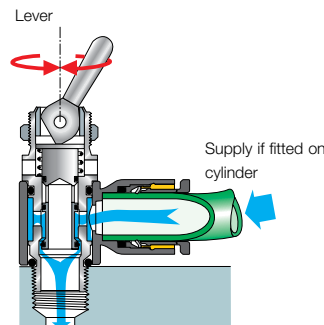

Supply if fitted on control valve

[Click here for CADs, Product Specifications or to Configure Parts Online](#)

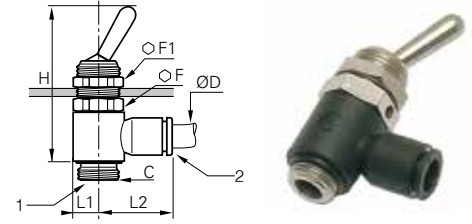
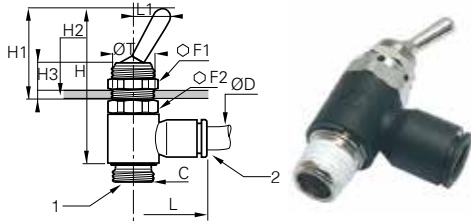

7805/7806 Manually Operated 3-Way Venting Valve Fractional Inch Tube to NPT

PART NO. SUPPLY (1)	ØD IN	C NPT	F1 MM	F2 MM	H IN	H1 IN	H2 IN	H3 IN	L IN	L1 IN	ØT IN	W OZ
7805 04 11	5/32	1/8	14	14	1.69	.98	.18	.30	.75	.43	.49	.95
7805 56 11	1/4	1/8	14	14	1.69	.98	.18	.30	.85	.43	.49	1.02
7805 56 14	1/4	1/4	14	17	1.99	.98	.18	.30	.89	.43	.49	1.55
7805 60 14	3/8	1/4	14	17	1.99	.98	.18	.30	1.14	.43	.49	1.69

PART NO. SUPPLY (2)	ØD IN	C NPT	F1 MM	F2 MM	H IN	H1 IN	H2 IN	H3 IN	L IN	L1 IN	ØT IN	W OZ
7806 04 11	5/32	1/8	14	14	1.69	.98	.18	.30	.75	.43	.49	.95
7806 56 11	1/4	1/8	14	14	1.69	.98	.18	.30	.85	.43	.49	1.02
7806 56 14	1/4	1/4	14	17	1.99	.98	.18	.30	.89	.43	.49	1.55
7806 60 14	3/8	1/4	14	17	1.99	.98	.18	.30	1.14	.43	.49	1.69

7800/7801 Manually Operated 3-Way Venting Valve Metric Tube to BSPP or Metric

PART NO. SUPPLY (1)	ØD MM	C BSPP	F MM	F1 MM	H MM	L1 MM	L2 MM	W KG
7800 04 19	4	M5X0.8	8	-	32	5	16	.020
7800 04 10	4	G1/8	14	14	42.5	7	18.5	.027
7800 06 19	6	M5X0.8	8	-	32	5	19	.022
7800 06 10	6	G1/8	14	14	42.5	7	20	.029
7800 06 13	6	G1/4	17	17	51	9	22	.044
7800 08 10	8	G1/8	14	14	42.5	7	25	.030
7800 08 13	8	G1/4	17	17	51	9	27	.045

PART NO. SUPPLY (2)	ØD MM	C BSPP	F MM	F1 MM	H MM	L1 MM	L2 MM	W KG
7801 04 19	4	M5X0.8	8	-	32	5	16	.020
7801 04 10	4	G1/8	14	14	42.5	7	18.5	.027
7801 06 19	6	M5X0.8	8	-	32	5	19	.022
7801 06 10	6	G1/8	14	14	42.5	7	20	.029
7801 06 13	6	G1/4	17	17	51	9	22	.044
7801 08 10	8	G1/8	14	14	42.5	7	25	.030

WARNING These products can expose you to chemicals including NICKEL, CARBON BLACK, TITANIUM DIOXIDE, or LEAD, which are known to the state of

7060/7065 – 7100/7105 Compact And Metal Flow Controls

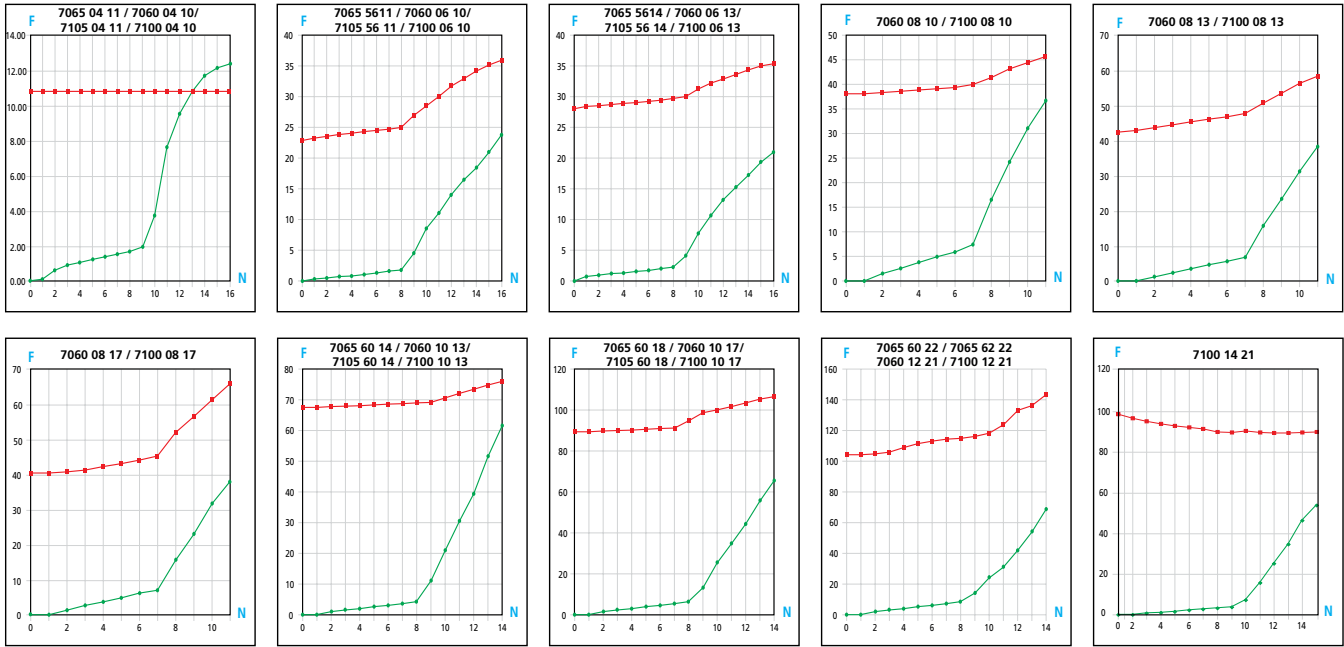

7066/7061

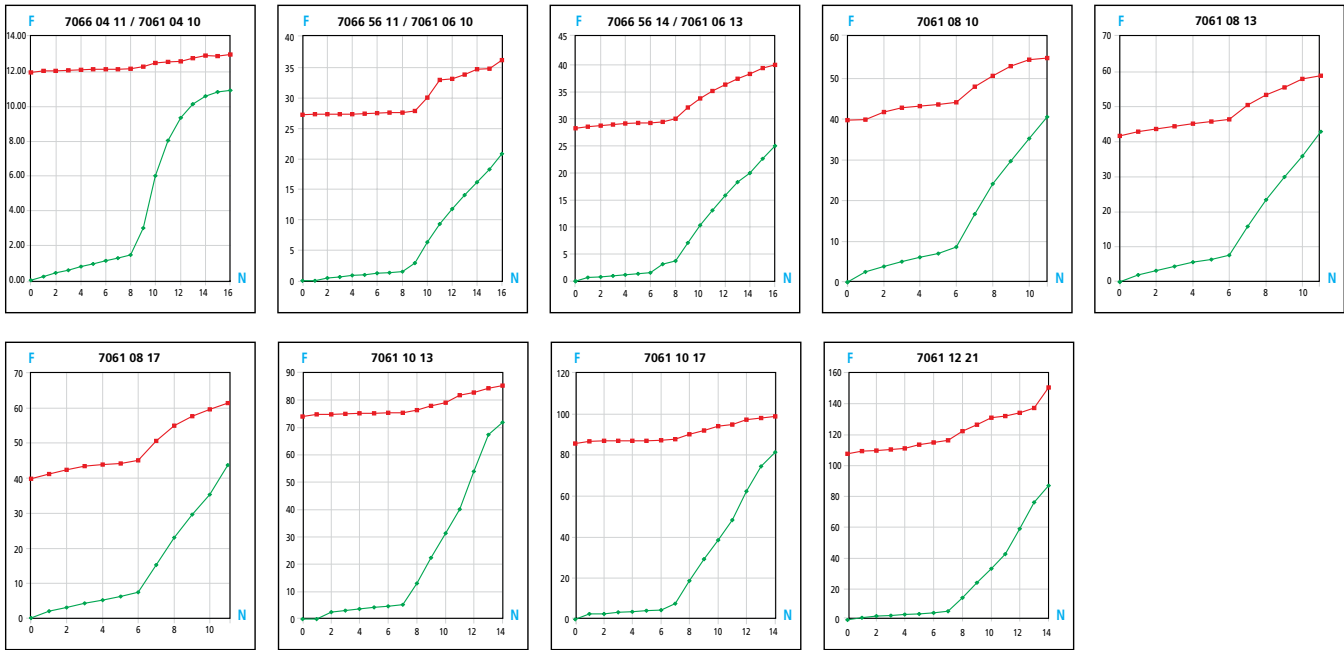

87 psi

█ = return direction **N** = number of turns
█ = controlled direction **F** = flow in SCFM

7067/7062

Flow characteristics of models 7067/7062:

- █ meter out version: see model 7065/7060 controlled direction
- █ meter in version: see model 7066/7061 controlled direction

7660/7665 – 7620/7625 – 7669 Mini Flow Controls

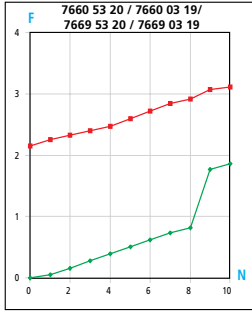
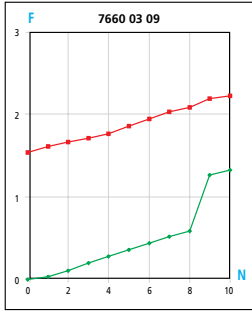

- Controlled Direction – 14.5 psi
- Controlled Direction – 72.5 psi
- Return Direction – 14.5 psi
- Return Direction – 72.5 psi
- Controlled Direction – 43.5 psi
- Controlled Direction – 101.5 psi
- Return Direction – 43.5 psi
- Return Direction – 101.5 psi

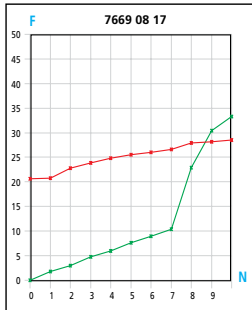
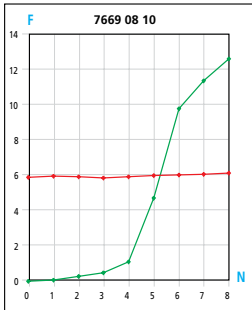
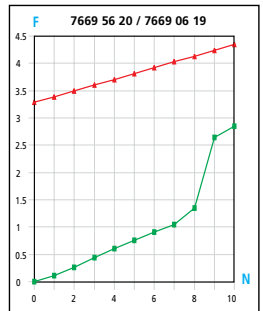
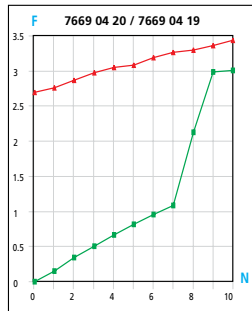
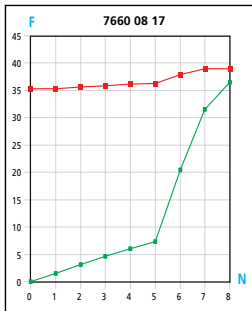
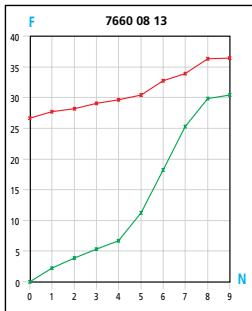
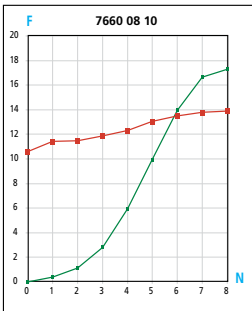
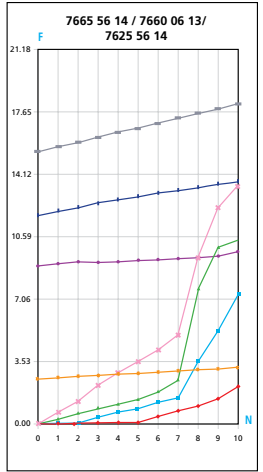
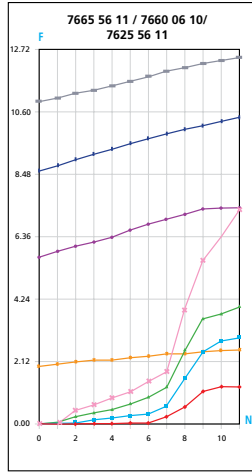
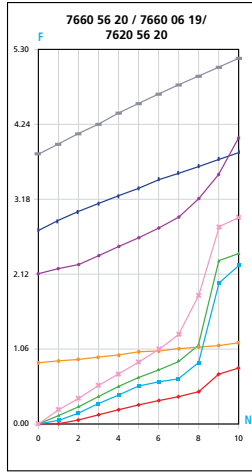
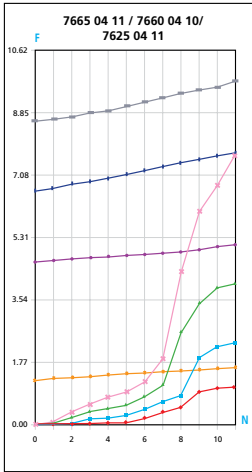
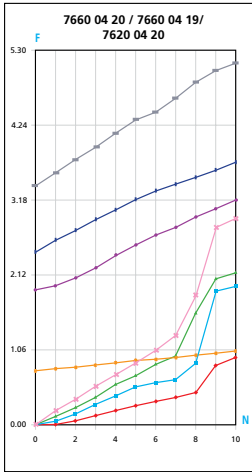

7662

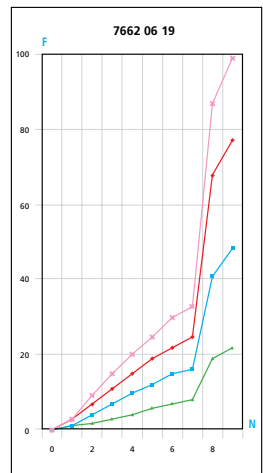
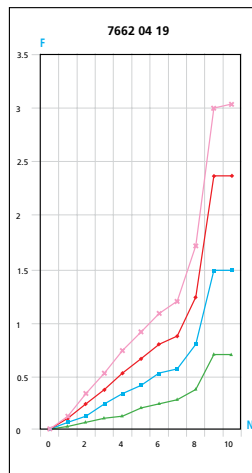

87 psi

- █ = return direction
- █ = controlled direction

- N** = number of turns
- F** = flow in SCFM

7630/7631/7030 Plug-In Flow Controls

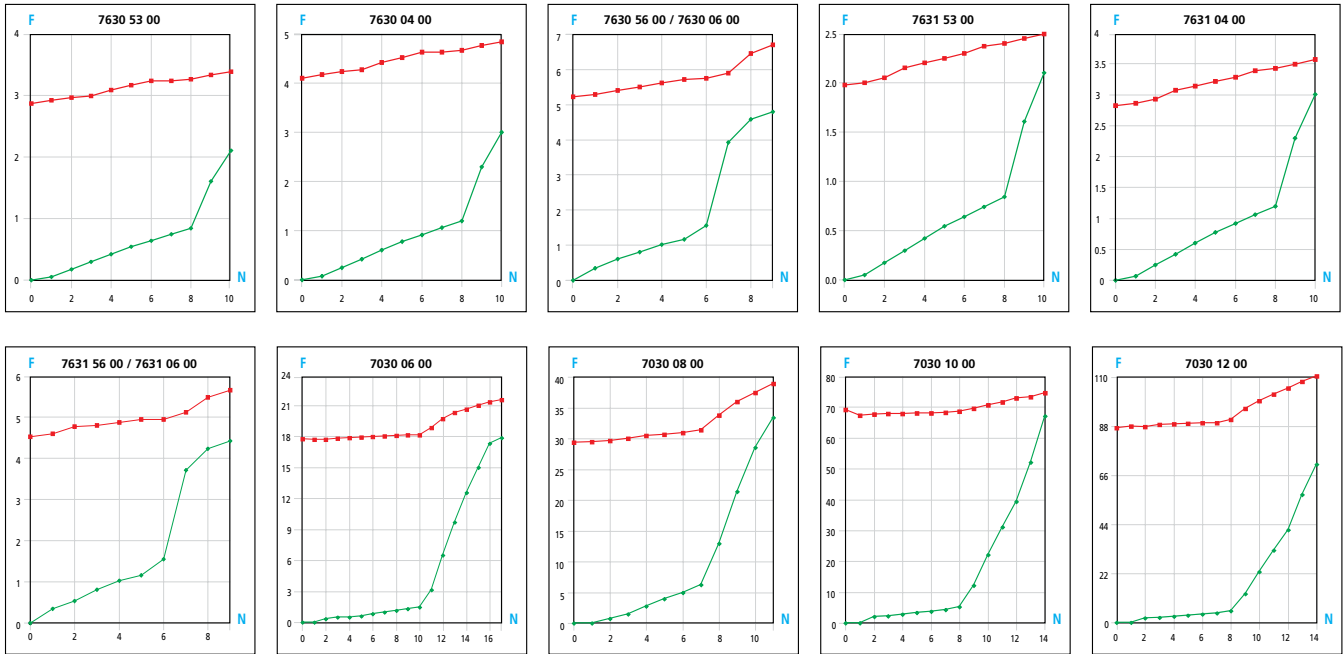

87 psi

- = return direction
- = controlled direction
- N** = number of turns
- F** = flow in SCFM

7010/7015 Knobless Flow Controls

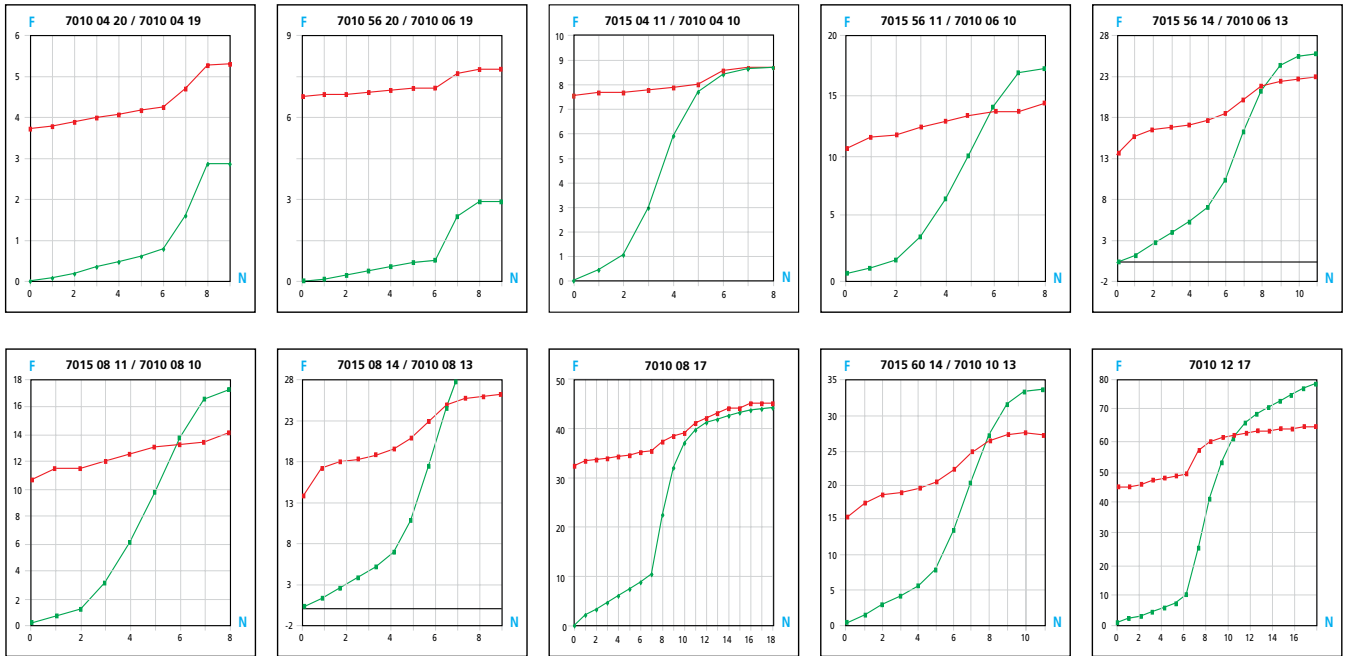

7011/7016

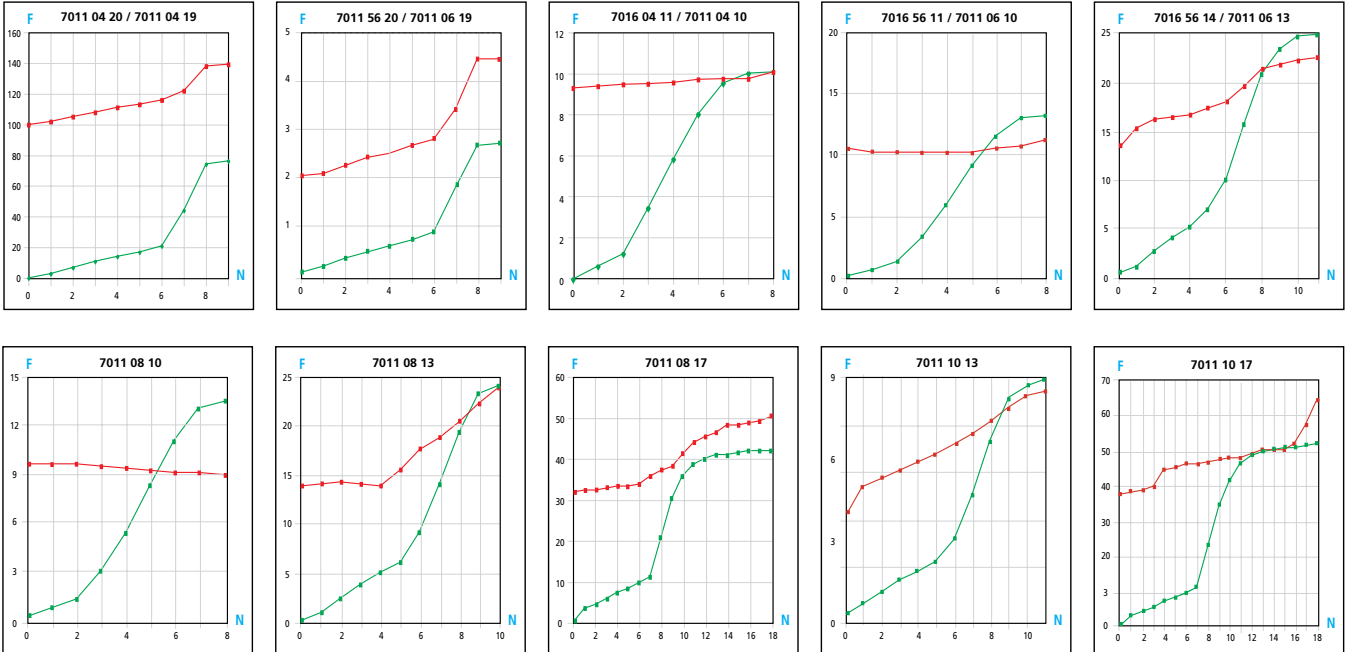

87 psi

█ = return direction
█ = controlled direction

N = number of turns
F = flow in SCFM

7012

Flow characteristics of models 7012:

█ meter out version: see model 7010 controlled direction
█ meter in version: see model 7011 controlled direction

7045 Swivel Outlet

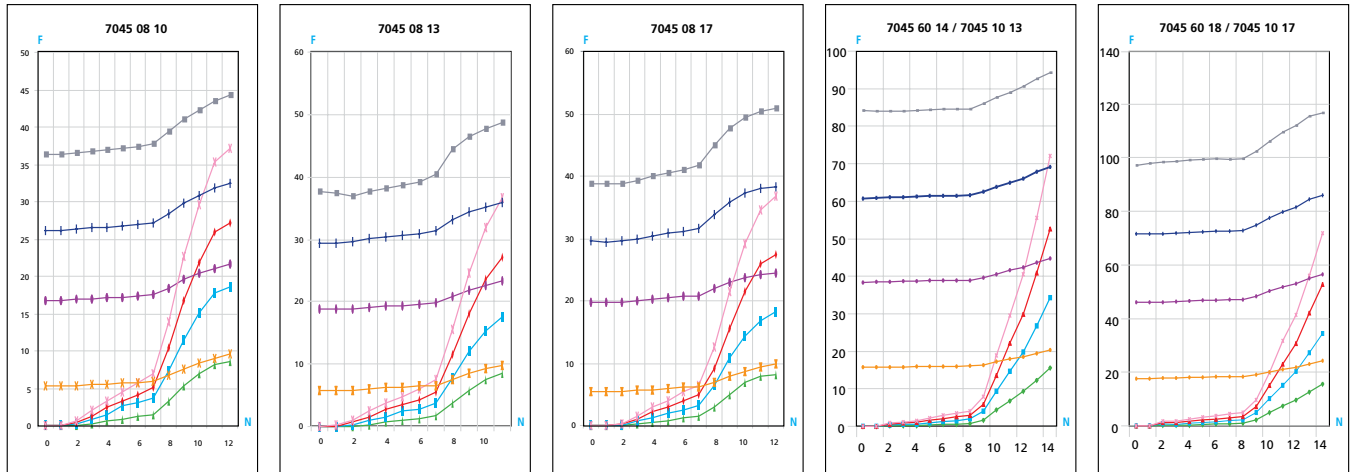

7640/7645

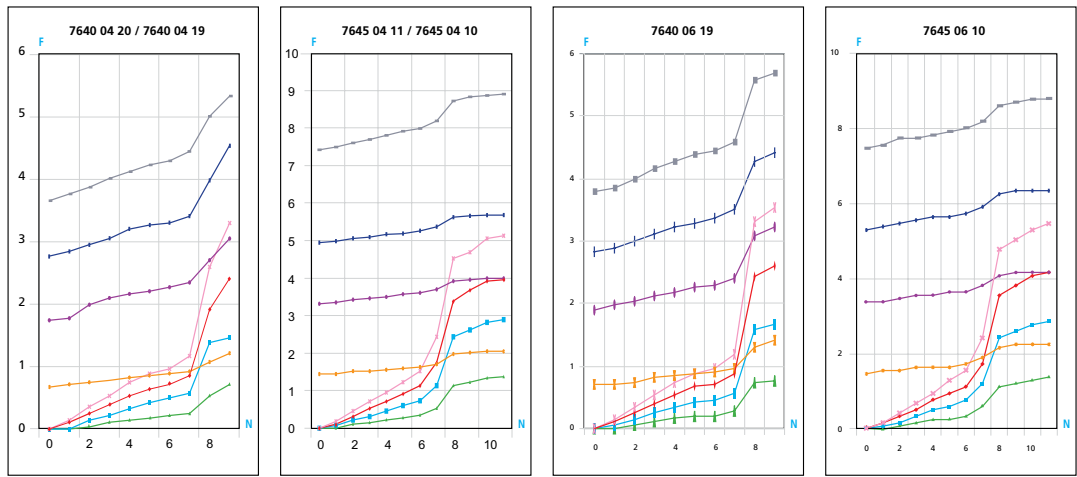

7649

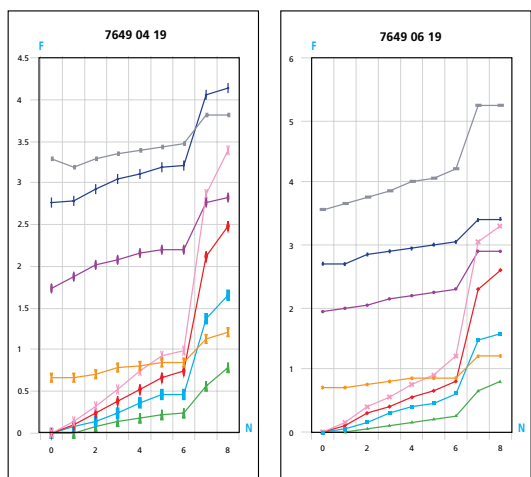

- Controlled Direction – 14.5 psi
- Controlled Direction – 43.5 psi
- Controlled Direction – 72.5 psi
- Controlled Direction – 101.5 psi
- Return Direction – 14.5 psi
- Return Direction – 43.5 psi
- Return Direction – 72.5 psi
- Return Direction – 101.5 psi

7770/7776 In-Line Flow Controls

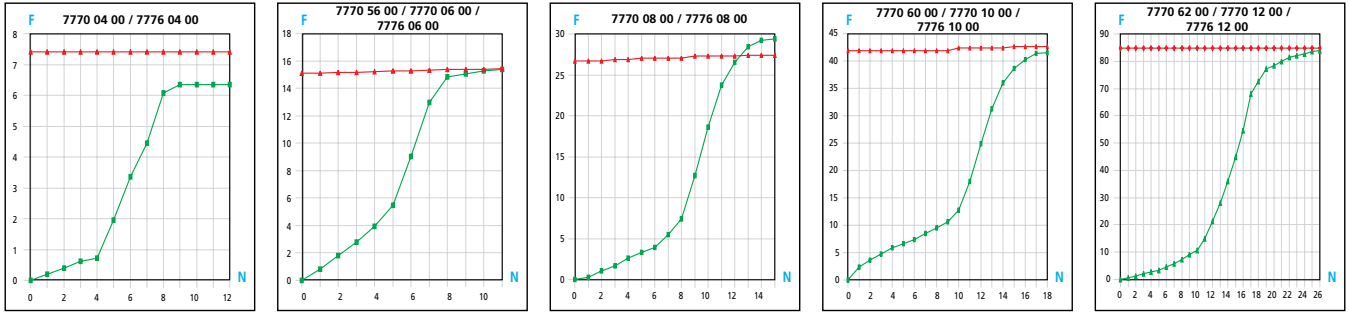

87 psi

- █ = return direction
- █ = controlled direction
- N** = number of turns
- F** = flow in SCFM

7772

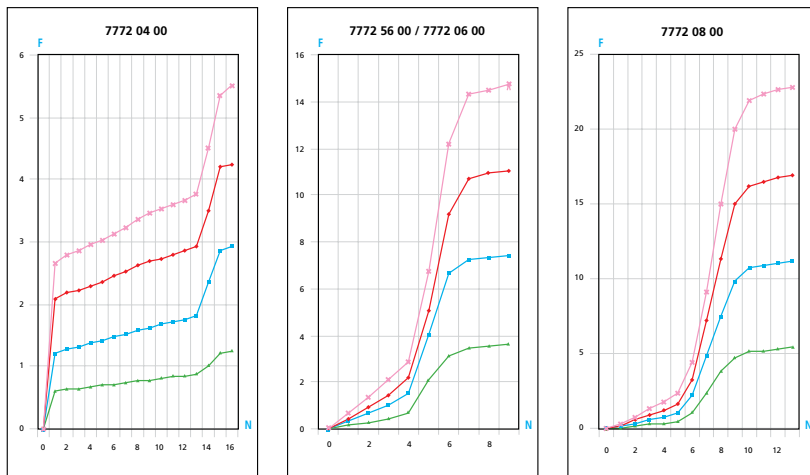

- Controlled Direction – 14.5 psi
- Controlled Direction – 72.5 psi
- Return Direction – 14.5 psi
- Return Direction – 72.5 psi
- Controlled Direction – 43.5 psi
- Controlled Direction – 101.5 psi
- Return Direction – 43.5 psi
- Return Direction – 101.5 psi



Water & Beverage: Thermoplastic Fittings and Valves

LIQUIfit Fittings

TrueSeal™ Fittings

Fast & Tite® Fittings

Par-Barb® Fittings



For more product information visit:
www.parker.com/water



GOODYEAR
RUBBER PRODUCTS, INC.

☎ 727-342-5088

You can also email us at
GRP@goodyearrubberproducts.com

LIQUIfit Fittings



Parker's LIQUIfit Fittings offer an innovative alternative for water applications. These fittings ensure reliable and compact connection for liquid transfer applications.

Product Features:

- Stainless steel grab ring
- Bio-sourced nylon 11
- EPDM D – seal
- FDA compliant, NSF/ANSI 51 and NSF/ANSI 61
- Silicone free
- 100% leak tested in production
- Date coding to guarantee quality and traceability

Markets:

- Water Filtration
- Beverage Dispensing
- Life Science
- Bottling
- Semi-Conductor

Applications:

- Water
- Beverages
- Food
- CO₂
- Vacuum

Specifications:

Pressure Range Up to 230 PSI (16 bar)

Temperature Range +35° to +200° F (+1.7° to +93.3° C)

Note: The working specification depends on the type and wall thickness of the tube, the type of fluid, fluid Temperature and ambient temperature

Compatible Tubing:

- Polyethylene

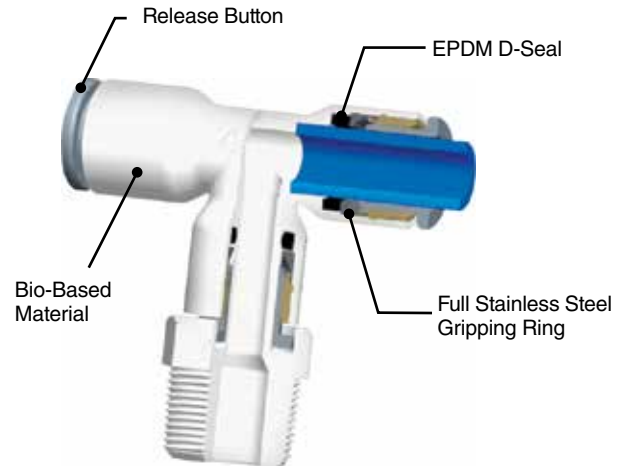

Assembly Instructions

1. Cut tubing squarely – maximum of 15° angle allowable.
2. Check that port or mating part is clean and free of debris.
3. Mark tubing to appropriate tube insertion length. (see Tube Insertion Chart on page N22)
4. Insert tubing until it bottoms
5. Pull on tubing to verify it is fully inserted
6. To disassemble, simply press release button, hold against body and pull tubing out of fitting.

■ Tube to Male NPTF

6505
Male Connector
p. B7



6579
Male Elbow
p. B8



6521
Male Standpipe
p. B8



6509
Male Elbow Swivel
p. B8



6508
Branch Tee Swivel
p. B9



6503
Run Tee Swivel
p. B9



6548
Male Y Connector
p. B13



■ Tube to Male BSPT

6505
Male Connector
p. B7



6579
Male Elbow
p. B8



6521
Male Standpipe
p. B8



6509
Male Elbow Swivel
p. B9



6508
Branch Tee Swivel
p. B9



6503
Run Tee Swivel
p. B10



■ Tube to Female Connector

6325
Faucet Connector
UNS
p. B8



6315
Female Connector
NPTF
p. B7



6315
Female Connector
BSPT
p. B7



AS
Angle Stop Fitting
p. B9



■ Bulkhead Union

6316
Bulkhead Union
p. B7



■ Tube to Tube

6306
Union
p. B10



6304
Union Tee
p. B10



6302
Union Elbow
p. B11



6340
Union Y
p. B11



6307
Cross
p. B13



■ Plug-Ins

6366
Tube Reducer
p. B11



6388
Plug-In Branch Tee
p. B12



6382
Plug-In Elbow
p. B12



6383
Plug-In Run Tee
p. B12



6380
Plug-In 45° Elbow
p. B13



■ Auxiliary Components

6351
End Cap
p. B12



6326
Plug
p. B13



6322
Barbed Connector
p. B13



■ **Liquifit Ball Valves**

VUC

Union Connector
p. B14



VME

Male Elbow
p. B14



VFE

Female Elbow
p. B15



VEU

Elbow Union
p. B15



VMC

Male Connector
p. B15



VFC

Female Connector
p. B15



VUCPB

Valve Union
Connector
Barbed x Tube
p. B16



VAS

Valve Angle Stop
p. B16



BVC

Ball Valve Clip
p. B16



[Click here for CADs, Product Specifications or to Configure Parts Online](#)

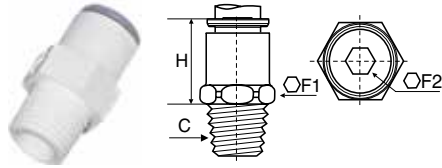

6505 Male Connector Inch Tube to NPTF

PART NO.	TUBE SIZE IN	C NPTF	F1	F2	H
6505 56 11WP2	1/4	1/8	1/2	5/32	.67
6505 56 14WP2	1/4	1/4	9/16	5/32	.67
6505 56 18WP2	1/4	3/8	3/4	1/4	.85
6505 60 11WP2	3/8	1/8	3/4	5/32	.87
6505 60 14WP2	3/8	1/4	3/4	1/4	.87
6505 60 18WP2	3/8	3/8	3/4	1/4	.87
6505 60 22WP2	3/8	1/2	15/16	1/4	1.06
6505 62 18WP2	1/2	3/8	15/16	3/8	1.10
6505 62 22WP2	1/2	1/2	15/16	3/8	1.10

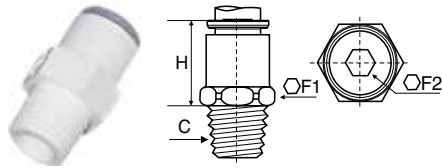

6505 Male Connector Metric Tube to BSPT

PART NO.	TUBE SIZE MM	C BSPT	F1	F2	H
6505 04 10WP2	4	1/8	11	3	18.00
6505 04 13WP2	4	1/4	14	3	18.00
6505 06 10WP2	6	1/8	11	4	18.00
6505 06 13WP2	6	1/4	14	4	18.00
6505 08 10WP2	8	1/8	17	6	20.00
6505 08 13WP2	8	1/4	17	6	20.00
6505 08 17WP2	8	3/8	17	6	20.00
6505 10 13WP2	10	1/4	17	7	21.50
6505 10 17WP2	10	3/8	19	7	21.50
6505 10 21WP2	10	1/2	22	7	21.50
6505 12 17WP2	12	3/8	19	9	24.50
6505 12 21WP2	12	1/2	22	9	24.50

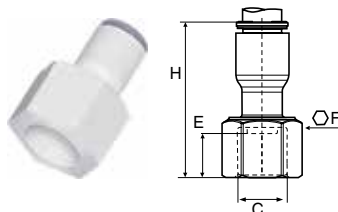

6315 Female Connector Inch Tube to NPTF

PART NO.	TUBE SIZE IN	C NPTF	E	F	H
6315 56 14WP2	1/4	1/4	14	11/16	1.18
6315 60 18WP2	3/8	3/8	14	3/16	1.42

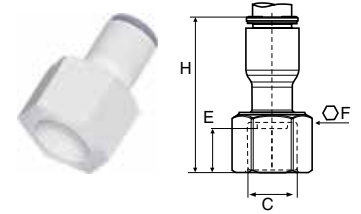

6315 Female Connector Metric Tube to BSPT

PART NO.	TUBE SIZE MM	C BSPT	E	F	H
6315 06 10WP2	6	1/8	11	13	32.00
6315 06 13WP2	6	1/4	14	16	33.00
6315 08 13WP2	8	1/4	14	16	33.50
6315 08 17WP2	8	3/8	14	20	36.00

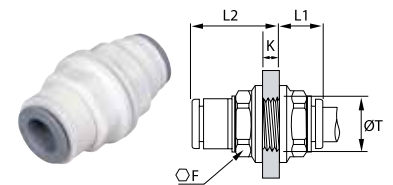

6316 Bulkhead Union Inch Tube

PART NO.	TUBE SIZE IN	F	K MAX	L1	L2	T MIN
6316 04 00WP2	5/32	.51	.22	.41	.61	.41
6316 56 00WP2	1/4	.59	.33	.39	.79	.49
6316 08 00WP2	5/16	.71	.57	.41	1.06	.61
6316 60 00WP2	3/8	.87	.57	.49	1.16	.73
6316 62 00WP2	1/2	1.41	.81	.67	1.59	1.00

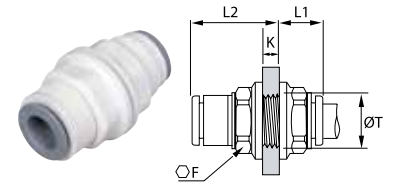

6316 Bulkhead Union Metric Tube

PART NO.	TUBE SIZE MM	F	K MAX	L1	L2	T MIN
6316 04 00WP2	4	13	5.50	10.50	15.50	10.50
6316 06 00WP2	6	15	8.50	10.00	20.00	12.50
6316 08 00WP2	8	18	14.50	10.50	27.00	15.50
6316 10 00WP2	10	22	14.50	13.00	30.00	18.50
6316 12 00WP2	12	26	18.50	15.50	35.00	22.50

WARNING These products can expose you to chemicals including NICKEL, CARBON BLACK, TITANIUM DIOXIDE, or LEAD, which are known to the state of

[Click here for CADs, Product Specifications or to Configure Parts Online](#)

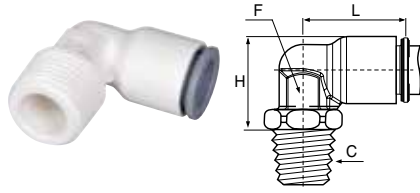

6579 Fixed Elbow Inch Tube to NPTF

PART NO.	TUBE SIZE IN	C NPTF	F	H	L
6579 56 11WP2	1/4	1/8	3/8	.54	.71
6579 56 14WP2	1/4	1/4	3/8	.54	.71
6579 56 18WP2	1/4	3/8	3/8	.54	.71
6579 60 14WP2	3/8	1/4	1/2	.77	1.02
6579 60 18WP2	3/8	3/8	1/2	.77	1.02

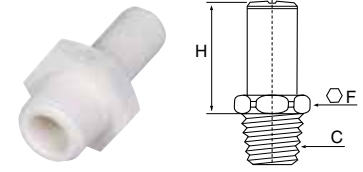

6521 Stem Adapter Inch Tube to NPTF

PART NO.	TUBE SIZE IN	C NPTF	F	H
6521 56 11WP2	1/4	1/8	1/2	.75
6521 56 14WP2	1/4	1/4	1/2	.75
6521 56 18WP2	1/4	3/8	3/4	.77
6521 60 14WP2	3/8	1/4	3/4	.98
6521 60 18WP2	3/8	3/8	3/4	.98
6521 62 18WP2	1/2	3/8	15/16	1.22
6521 62 22WP2	1/2	1/2	15/16	1.28

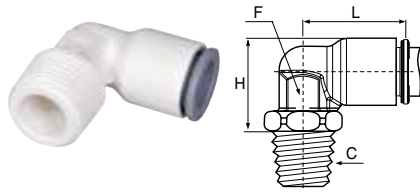

6579 Fixed Elbow Metric Tube to BSPT

PART NO.	TUBE SIZE MM	C BSPT	F	H	L
6579 06 10WP2	6	1/8	10	14	19
6579 06 13WP2	6	1/4	10	14	19
6579 06 17WP2	6	3/8	10	14	19

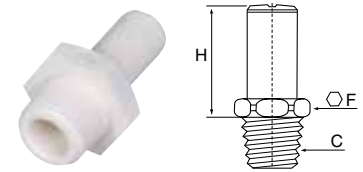

6521 Stem Adapter Metric Tube to BSPT

PART NO.	TUBE SIZE MM	C BSPT	F	H
6521 06 10WP2	6	1/8	13	19
6521 06 13WP2	6	1/4	14	19
6521 06 17WP2	6	3/8	17	19
6521 08 10WP2	8	1/8	19	23
6521 08 13WP2	8	1/4	19	23
6521 08 17WP2	8	3/8	19	23
6521 10 13WP2	10	1/4	19	25
6521 10 17WP2	10	3/8	19	25
6521 10 21WP2	10	1/2	22	25
6521 12 17WP2	12	3/8	22	28
6521 12 21WP2	12	1/2	22	28

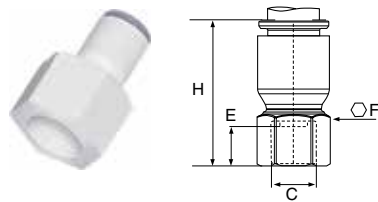

6325 Faucet Connector Inch Tube to UNS

PART NO.	TUBE SIZE IN	C UNS	E	F	H
6325 56 133WP2	1/4	7/16-24	27	9/16	1.22
6325 60 133WP2	3/8	7/16-24	27	9/16	1.26

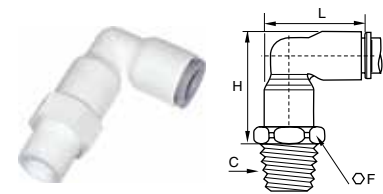

6509 Swivel Elbow Inch Tube to NPTF

PART NO.	TUBE SIZE IN	C NPTF	F	H	L
6509 56 11WP2	1/4	1/8	1/2	1.10	.93
6509 56 14WP2	1/4	1/4	9/16	1.10	.93
6509 56 18WP2	1/4	3/8	3/4	1.12	.93
6509 60 14WP2	3/8	1/4	3/4	1.50	1.34
6509 60 18WP2	3/8	3/8	3/4	1.50	1.34
6509 62 18WP2	1/2	3/8	15/16	1.99	1.83
6509 62 22WP2	1/2	1/2	15/16	1.99	1.83

WARNING These products can expose you to chemicals including NICKEL, CARBON BLACK, TITANIUM DIOXIDE, or LEAD, which are known to the state of

[Click here for CADs, Product Specifications or to Configure Parts Online](#)

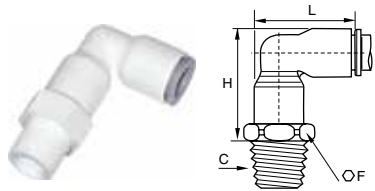

6509 Swivel Elbow Metric Tube to BSPT

PART NO.	TUBE SIZE MM	C BSPT	F	H	L
6509 06 10WP2	6	1/8	13	28	24.00
6509 06 13WP2	6	1/4	14	28	24.00
6509 06 17WP2	6	3/8	17	28	24.00
6509 08 10WP2	8	1/8	19	34	29.50
6509 08 13WP2	8	1/4	19	34	29.50
6509 08 17WP2	8	3/8	19	34	29.50
6509 10 13WP2	10	1/4	19	38	34.50
6509 10 17WP2	10	3/8	19	38	34.50
6509 10 21WP2	10	1/2	22	38	34.50
6509 12 17WP2	12	3/8	22	44	40.00
6509 12 21WP2	12	1/2	22	44	40.00

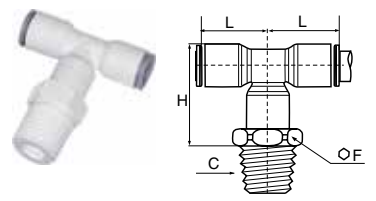

6508 Swivel Branch Tee Metric Tube to BSPT

PART NO.	TUBE SIZE MM	C BSPT	F	H	L
6508 06 10WP2	6	1/8	13	28.00	18.00
6508 06 13WP2	6	1/4	14	28.00	18.00
6508 06 17WP2	6	3/8	17	28.00	18.00
6508 08 10WP2	8	1/8	19	34.00	23.00
6508 08 13WP2	8	1/4	19	34.00	23.00
6508 08 17WP2	8	3/8	19	34.00	23.00
6508 10 13WP2	10	1/4	19	38.00	26.50
6508 10 17WP2	10	3/8	19	38.00	26.50
6508 10 21WP2	10	1/2	22	38.00	26.50
6508 12 17WP2	12	3/8	22	44.00	31.00
6508 12 21WP2	12	1/2	22	44.00	31.00

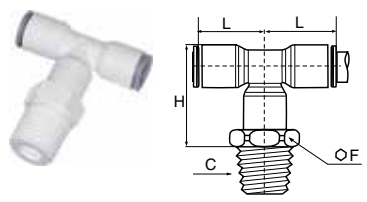

6508 Swivel Branch Tee Inch Tube to NPTF

PART NO.	TUBE SIZE IN	C NPTF	F	H	L
6508 56 11WP2	1/4	1/8	1/2	1.10	.71
6508 56 14WP2	1/4	1/4	9/16	1.10	.71
6508 56 18WP2	1/4	3/8	3/4	1.10	.71
6508 60 14WP2	3/8	1/4	3/4	1.50	1.02
6508 60 18WP2	3/8	3/8	3/4	1.50	1.02
6508 62 18WP2	1/2	3/8	15/16	1.97	1.40
6508 62 22WP2	1/2	1/2	15/16	2.00	1.40

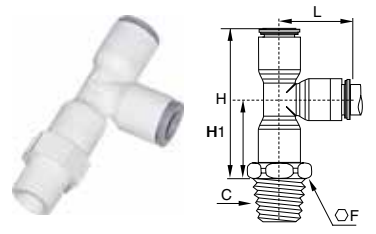

6503 Swivel Run Tee Inch Tube to NPTF

PART NO.	TUBE SIZE IN	C NPTF	F	H	H1	L
6503 56 11WP2	1/4	1/8	1/2	1.60	.88	.71
6503 56 14WP2	1/4	1/4	9/16	1.60	.88	.71
6503 56 18WP2	1/4	3/8	3/4	1.63	.90	.71
6503 60 14WP2	3/8	1/4	3/4	1.63	1.18	1.02
6503 60 18WP2	3/8	3/8	3/4	1.63	1.18	1.02
6503 62 18WP2	1/2	3/8	15/16	2.29	1.55	1.40
6503 62 22WP2	1/2	1/2	15/16	2.99	1.59	1.40

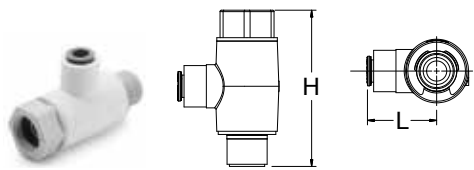

AS Angle Stop Fitting

PART NO.	TUBE SIZE IN	MALE THD.	FEMALE THD.	UNEF THD.	H	L
LFPP4AS6	1/4	3/8	3/8	9/16-24	2.17	.96

WARNING These products can expose you to chemicals including NICKEL, CARBON BLACK, TITANIUM DIOXIDE, or LEAD, which are known to the state of

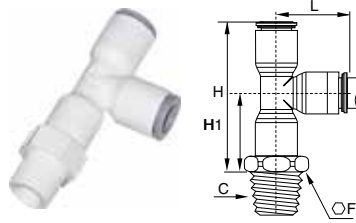
[Click here for CADs, Product Specifications or to Configure Parts Online](#)

6503 Swivel Run Tee Metric Tube to BSPT

PART NO.	TUBE SIZE MM	C BSPT	F	H	H1	L
6503 06 13WP2	6	1/4	14	40.00	22.00	18.50
6503 08 10WP2	8	1/8	19	50.00	27.00	23.00
6503 08 13WP2	8	1/4	19	50.00	27.00	23.00
6503 08 17WP2	8	3/8	19	50.00	27.00	23.00
6503 12 17WP2	12	3/8	22	65.50	34.50	31.00
6503 12 21WP2	12	1/2	22	65.50	34.50	31.00

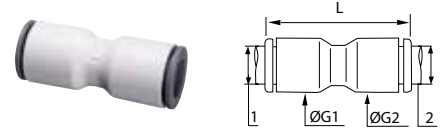

6306 Union Connector Metric Tube

PART NO.	TUBE 1 SIZE MM	TUBE 2 SIZE MM	G1	G2	L
6306 04 00WP2	4	4	8.50	8.50	26.50
6306 06 00WP2	6	6	10.50	10.50	30.00
6306 08 00WP2	8	8	13.50	13.50	37.00
6306 10 00WP2	10	10	16.00	16.00	42.00
6306 12 00WP2	12	12	19.00	19.00	50.50
6306 04 06WP2	4	6	8.50	10.50	29.00
6306 04 08WP2	4	8	13.50	13.50	37.00
6306 06 08WP2	6	8	13.50	13.50	37.00
6306 06 10WP2	6	10	16.00	16.00	42.00
6306 08 10WP2	8	10	16.00	16.00	42.00
6306 08 12WP2	8	12	19.00	19.00	50.00
6306 10 12WP2	10	12	19.00	19.00	50.00

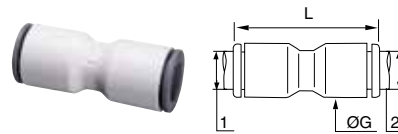

6306 Union Connector Inch Tube

PART NO.	TUBE 1 SIZE IN	TUBE 2 SIZE IN	G	L
6306 56 00WP2	1/4	1/4	.43	1.18
6306 08 00WP2	5/16	5/16	.53	1.46
6306 60 00WP2	3/8	3/8	.63	1.65
6306 62 00WP2	1/2	1/2	.87	2.24
6306 56 60WP2	1/4	3/8	.63	1.61
6306 56 08WP2	1/4	5/16	.53	1.46
6306 08 60WP2	5/16	3/8	.63	1.65
6306 08 62WP2	5/16	1/2	.87	2.16
6306 60 62WP2	3/8	1/2	.87	2.20

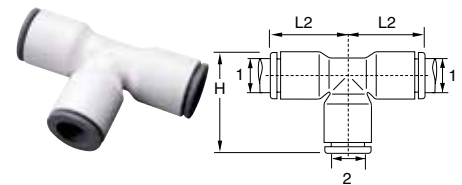

6304 Union Tee Inch Tube

PART NO.	TUBE 1 SIZE IN	TUBE 2 SIZE IN	H	L2
6304 04 00WP2	5/32	5/32	.79	.61
6304 56 00WP2	1/4	1/4	.94	.71
6304 08 00WP2	5/16	5/16	1.14	.89
6304 60 00WP2	3/8	3/8	1.34	1.02
6304 62 00WP2	1/2	1/2	1.85	1.42
6304 60 56WP2	3/8	1/4	1.34	1.02
6304 62 60WP2	1/2	3/8	1.85	1.42

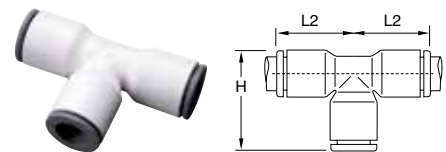

6304 Union Tee Metric Tube

PART NO.	TUBE SIZE MM	H	L2
6304 04 00WP2	4	20.00	15.50
6304 06 00WP2	6	23.00	18.00
6304 08 00WP2	8	29.00	22.50
6304 10 00WP2	10	34.50	26.50
6304 12 00WP2	12	40.00	31.00

⚠ WARNING: These products can expose you to chemicals including NICKEL, CARBON BLACK, TITANIUM DIOXIDE, or LEAD, which are known to the state of

[Click here for CADs, Product Specifications or to Configure Parts Online](#)

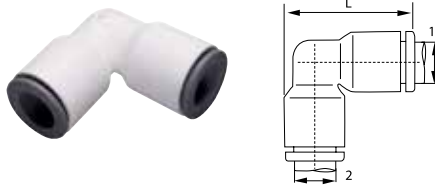

6302 Union Elbow Inch Tube

PART NO.	TUBE 1 SIZE IN	TUBE 2 SIZE IN	L
6302 04 00WP2	5/32	5/32	.75
6302 56 00WP2	1/4	1/4	.94
6302 08 00WP2	5/16	5/16	1.16
6302 60 00WP2	3/8	3/8	1.34
6302 62 00WP2	1/2	1/2	1.79
6302 56 08WP2	1/4	5/16	1.16
6302 08 60WP2	5/16	3/8	1.34
6302 56 60WP2	3/8	1/4	1.30
6302 60 62WP2	3/8	1/2	1.83

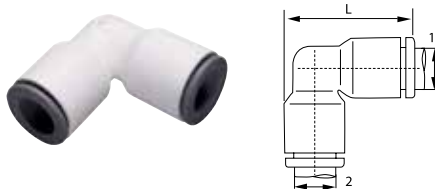

6302 Union Elbow Metric Tube

PART NO.	TUBE 1 SIZE MM	TUBE 2 SIZE MM	L
6302 04 00WP2	4	4	19.50
6302 06 00WP2	6	6	24.00
6302 08 00WP2	8	8	29.50
6302 10 00WP2	10	10	34.50
6302 12 00WP2	12	12	40.50
6302 04 06WP2	4	6	24.00
6302 06 08WP2	6	8	29.50
6302 08 10WP2	8	10	34.50
6302 10 12WP2	10	12	40.50

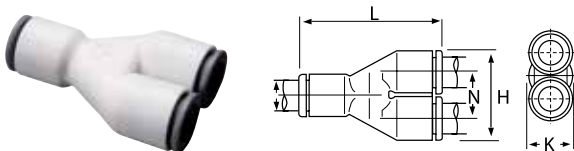

6340 Union Y Connector Inch Tube

PART NO.	TUBE SIZE IN	H	K	L	N
6340 04 00WP2	5/32	.69	.33	1.18	.35
6340 56 00WP2	1/4	.87	.43	1.42	.45
6340 08 00WP2	5/16	1.10	.53	1.75	.57
6340 60 00WP2	3/8	1.30	.63	2.08	.67
6340 62 00WP2	1/2	1.77	.87	2.64	.91

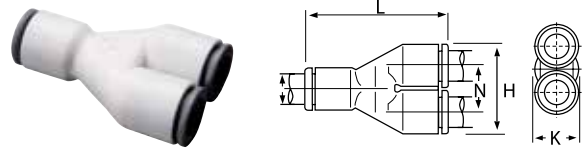

6340 Union Y Connector Metric Tube

PART NO.	TUBE SIZE MM	H	K	L	N
6340 04 00WP2	4	17.50	8.50	30.00	9.00
6340 06 00WP2	6	21.50	10.50	36.50	11.00
6340 08 00WP2	8	28.00	13.50	44.50	14.50
6340 10 00WP2	10	33.00	16.00	53.00	17.00
6340 12 00WP2	12	39.00	19.00	60.50	20.00

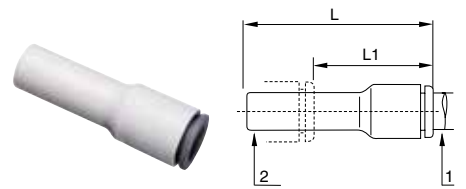

6366 Reducer Inch Tube to Stem

PART NO.	TUBE 1 SIZE IN	TUBE 2 SIZE IN	L	L1
6366 56 08WP2	1/4	5/16	1.61	.89
6366 56 60WP2	1/4	3/8	1.61	.81
6366 08 60WP2	5/16	3/8	1.91	1.14
6366 08 62WP2	5/16	1/2	1.91	.87
6366 60 62WP2	3/8	1/2	2.01	1.18

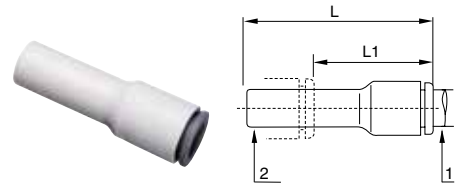

6366 Reducer Metric Tube to Stem

PART NO.	TUBE 1 SIZE MM	TUBE 2 SIZE MM	L	L1
6366 04 06WP2	4	6	38.00	23.50
6366 04 08WP2	4	8	38.00	19.00
6366 06 08WP2	6	8	38.00	20.00
6366 06 10WP2	6	10	39.00	17.50
6366 08 10WP2	8	10	48.50	28.50
6366 08 12WP2	8	12	48.50	24.50
6366 10 12WP2	10	12	52.00	33.50
6366 10 14WP2	10	14	53.00	33.50
6366 12 14WP2	12	14	55.50	33.50

WARNING These products can expose you to chemicals including NICKEL, CARBON BLACK, TITANIUM DIOXIDE, or LEAD, which are known to the state of

[Click here for CADs, Product Specifications or to Configure Parts Online](#)

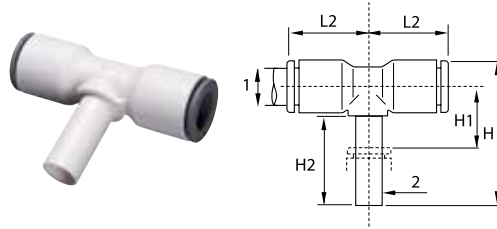

6388 Plug-In Tee Inch Tube to Stem

PART NO.	TUBE 1 SIZE IN	TUBE 2 SIZE IN	H	H1	H2	L2
6388 56 00WP2	1/4	1/4	1.20	.43	.79	.71
6388 08 00WP2	5/16	5/16	1.32	.31	.85	.90
6388 60 00WP2	3/8	3/8	1.65	.49	.98	.98
6388 62 00WP2	1/2	1/2	2.01	.51	1.14	1.26

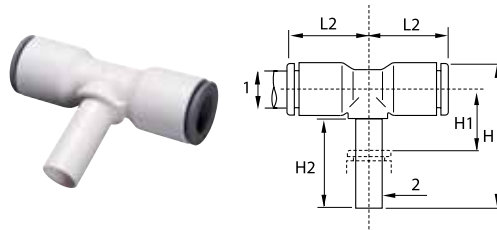

6388 Plug-In Tee Metric Tube to Stem

PART NO.	TUBE 1 SIZE MM	TUBE 2 SIZE MM	H	H1	H2	L2
6388 04 00WP2	4	4	25.00	6.00	15.50	15.00
6388 06 00WP2	6	6	28.50	7.00	17.00	16.00
6388 08 00WP2	8	8	33.50	8.00	21.50	23.00
6388 10 00WP2	10	10	41.00	9.50	24.50	26.50

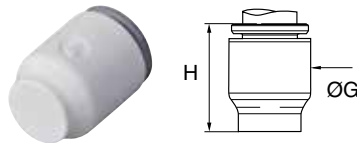

6351 End Stop Inch Tube

PART NO.	TUBE SIZE IN	G	H
6351 04 00WP2	5/32	.33	.59
6351 56 00WP2	1/4	.43	.63
6351 08 00WP2	5/16	.53	.85
6351 60 00WP2	3/8	.63	.88

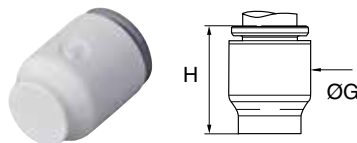

6351 End Stop Metric Tube

PART NO.	TUBE SIZE MM	G	H
6351 04 00WP2	4	8.50	15.00
6351 06 00WP2	6	10.50	17.00
6351 08 00WP2	8	13.50	21.50
6351 10 00WP2	10	16.00	22.00
6351 12 00WP2	12	19.00	27.50

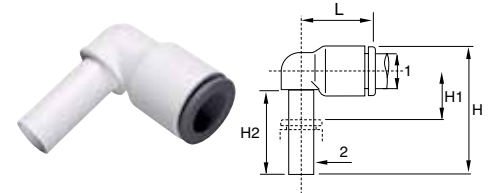

6382 Plug-In Elbow Inch Tube to Stem

PART NO.	TUBE 1 SIZE IN	TUBE 2 SIZE IN	H	H1	H2	L
6382 56 00WP2	1/4	1/4	1.20	.43	.71	.71
6382 08 00WP2	5/16	5/16	1.32	.31	.85	.88
6382 60 00WP2	3/8	3/8	1.53	.35	.96	1.04
6382 56 60WP2	1/4	3/8	1.93	.51	1.12	1.42
6382 60 56WP2	3/8	1/4	1.26	.43	.71	1.04

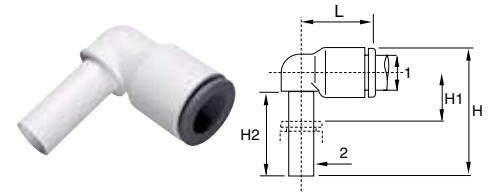

6382 Plug-In Elbow Metric Tube to Stem

PART NO.	TUBE 1 SIZE MM	TUBE 2 SIZE MM	H	H1	H2	L
6382 04 00WP2	4	4	23.00	6.00	15.50	15.00
6382 06 00WP2	6	6	26.50	7.00	17.00	17.00
6382 08 00WP2	8	8	33.00	8.00	21.50	22.50
6382 10 00WP2	10	10	39.00	9.50	24.50	26.50
6382 12 00WP2	12	12	44.50	10.00	27.00	31.00
6382 04 06WP2	4	6	26.50	7.00	17.00	16.50
6382 06 04WP2	6	4	25.00	7.00	15.50	17.00
6382 06 08WP2	6	8	33.50	8.00	21.50	22.50
6382 08 10WP2	8	10	39.00	9.50	24.50	26.00
6382 10 12WP2	10	12	44.50	10.00	27.00	30.00

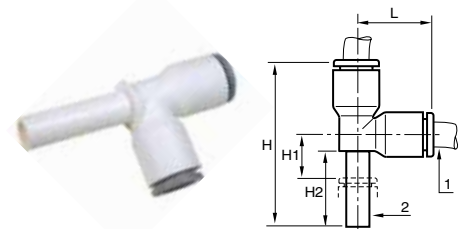

6383 Plug-In Run Tee Inch Tube to Stem

PART NO.	TUBE 1 SIZE IN	TUBE 2 SIZE IN	H	H1	H2	L
6383 56 00WP2	1/4	1/4	1.20	.43	.71	.71
6383 60 00WP2	3/8	3/8	2.24	.43	.96	1.04
6383 62 00WP2	1/2	1/2	1.93	.71	1.12	1.42

WARNING These products can expose you to chemicals including NICKEL, CARBON BLACK, TITANIUM DIOXIDE, or LEAD, which are known to the state of

[Click here for CADs, Product Specifications or to Configure Parts Online](#)

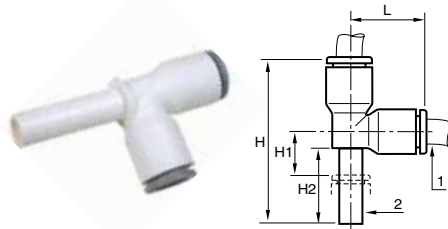

6383 Plug-In Run Tee Metric Tube to Stem

PART NO.	TUBE 1 SIZE MM	TUBE 2 SIZE MM	H	H1	H2	L
6383 04 00WP2	4	4	33.00	6.00	15.50	15.00
6383 06 00WP2	6	6	38.50	7.00	17.00	18.00
6383 08 00WP2	8	8	49.00	8.00	21.50	23.00
6383 10 00WP2	10	10	57.00	10.50	25.50	26.50

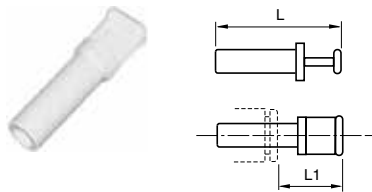

6326 Plug Inch

PART NO.	STEM SIZE IN	L	L1
6326 56 00WP2	1/4	1.44	.87
6326 08 00WP2	5/16	1.38	.69
6326 60 00WP2	3/8	1.67	.87
6326 62 00WP2	1/2	1.91	.85

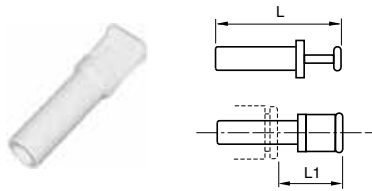

6326 Plug Metric

PART NO.	STEM SIZE MM	L	L1
6326 04 00WP2	4	30	15.5
6326 06 00WP2	6	33	16.5
6326 08 00WP2	8	33	17.5
6326 10 00WP2	10	42	21.0
6326 12 00WP2	12	45	22.0

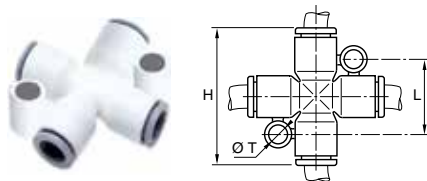

6307 Cross Metric

PART NO.	TUBE SIZE MM	H	L	T
6307 06 00WP2	6	46	22.5	4.2
6307 08 00WP2	8	46	22.5	4.2

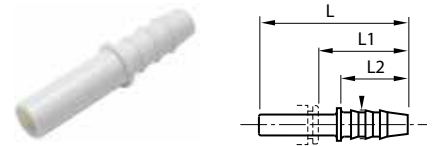

6322 Stem to Hose Barb Inch

PART NO.	STEM SIZE IN	HOSE BARB	L	L1	L2
6322 56 56WP2	1/4	1/4	1.65	1.00	.67
6322 60 56WP2	3/8	1/4	1.97	1.16	.87
6322 60 08WP2	3/8	5/16	1.97	1.16	.87
6322 60 60WP2	3/8	3/8	1.97	1.16	.87
6322 62 60WP2	1/2	3/8	2.05	1.30	1.07

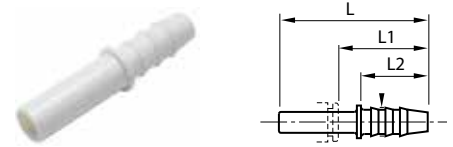

6322 Stem to Hose Barb Metric

PART NO.	STEM SIZE MM	HOSE BARB	L	L1	L2
6322 06 04WP2	6	4	37.0	25.0	17
6322 08 06WP2	8	6	39.5	21.0	17
6322 10 07WP2	10	7	50.0	29.5	22

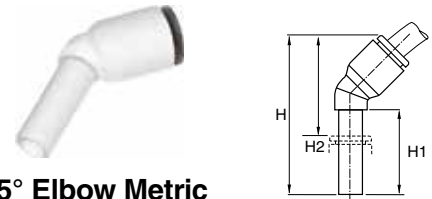

6380 Plug-in 45° Elbow Metric

PART NO.	TUBE SIZE MM	STEM SIZE MM	H	H1	H2
6380 04 00WP2	4	4	33.5	19.0	13.0
6380 06 00WP2	6	6	39.0	21.0	14.5
6380 08 00WP2	8	8	44.0	21.5	19.5
6380 10 00WP2	10	10	53.0	27.0	23.0
6380 12 00WP2	12	12	58.5	27.5	26.5

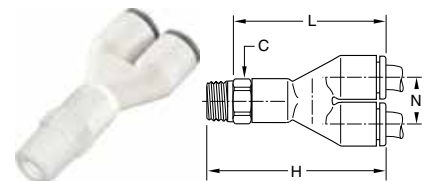

6548 Swivel Y Connector Inch Tube to NPTF

PART NO.	TUBE SIZE IN	NPTF	C HEX	L	H	N
6548 56 11WP2	1/4	1/8	1/2	1.59	.88	.45
6548 56 14WP2	1/4	1/4	1/2	1.59	.88	.45
6548 56 18WP2	1/4	3/8	3/4	1.62	.88	.45
6548 60 14WP2	3/8	1/4	3/4	2.24	1.30	.66
6548 60 18WP2	3/8	3/8	3/4	2.24	1.30	.66
6548 62 18WP2	1/2	3/8	15/16	2.80	1.78	.91
6548 62 22WP2	1/2	1/2	15/16	2.84	1.78	.91

WARNING These products can expose you to chemicals including NICKEL, CARBON BLACK, TITANIUM DIOXIDE, or LEAD, which are known to the state of

LIQUIfit Polypropylene Ball Valves

This range of valves offers an innovative solution in the treatment of water and the handling of beverages while protecting health. LIQUIfit's corrosion-resistant, all plastic design makes them ideal for water filtration units, coffee and beverage machines and a wide variety of other fluid applications. The polypropylene material meets all FDA and NSF-51 requirements for food contact.

Assembly Instructions:

1. Inspect the mating threads for debris or damage. Remove any old fluoropolymer tape or sealant on previously used threads. If threads are damaged, replace with new adapter before proceeding.
2. Apply 2 to 3 wraps of fluoropolymer tape, or an NSF/FDA approved silicone sealant. Do not use Plumbers Putty or Pipe Dope. These chemically react with plastic materials and could cause a failure.
3. Align ball valve onto mating thread to ensure cross threading does not occur.
4. Screw ball valve onto mating thread 3 to 5 turns. This should be sufficient to properly seal the threads.
5. Pressurize system and check for leaks.

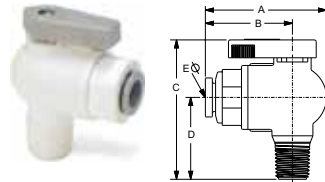

VME - Valve Male Elbow

PART NO.	NOM. TUBE O.D.	NPTF THREAD SIZE	A	B	C	D	ØE THRU HOLE MIN.
LFPP4VME2	1/4	1/8	1.74	1.21	2.00	1.10	.19
LFPP4VME4	1/4	1/4	1.74	1.21	2.18	1.28	.19
LFPP4VME6	1/4	3/8	1.74	1.21	2.18	1.28	.19
LFPP4VME8	1/4	1/2	1.74	1.21	2.37	1.47	.19
LFPP6VME2	3/8	1/8	1.85	1.32	2.00	1.10	.25
LFPP6VME4	3/8	1/4	1.85	1.32	2.18	1.28	.25
LFPP6VME6	3/8	3/8	1.85	1.32	2.18	1.28	.25
LFPP6VME8	3/8	1/2	1.85	1.32	2.37	1.47	.25
LFPP8VME8	1/2	1/2	2.73	1.74	2.38	1.47	.37

Features/Benefits:

- Full-flow self-cleaning ball maintains the cleanliness of the circuit
- Sealing technology using EPDM D seal
- High temperature, scale-resistant Polysulfone ball
- Tube retention with gripping ring prevents pumping effect
- Push-in connection and disconnection
- FDA compliant

Specifications:

- Temperature range: +35° F to +200° F (+1° C to +93° C)
- O-ring seal material: EPDM
- NSF/ANSI 51 AND 61
- Pressure rated to 150 psi

Advantages:

- Reduce costs – Built-in LIQUIfit connection eliminates the need for a secondary fitting
- Save space – Low profile design allows for easy assembly and access where space is at a premium.

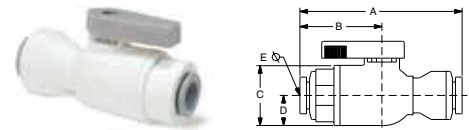

VUC - Valve Union Connector

PART NO.	1 TUBE SIZE	2 TUBE SIZE	A	B	C	D	ØE THRU HOLE MIN.
LFPP4VUC4	1/4	1/4	2.23	1.07	1.00	.50	.19
LFPP4VUC6	1/4	3/8	2.50	1.07	1.00	.50	.19
LFPP6VUC6	3/8	3/8	2.74	1.32	1.00	.50	.25
LFPP8VUC8	1/2	1/2	3.50	1.74	1.04	.52	.37

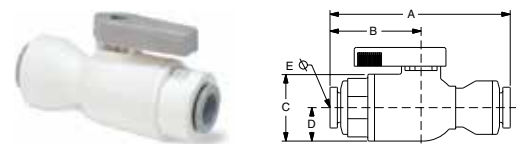

VUC - Valve Union Connector Metric

PART NO.	1 TUBE SIZE	2 TUBE SIZE	A	B	C	D	ØE THRU HOLE MIN.
LFPP6MVUC6M	6	6	.57	.27	.36	.13	.19
LFPP8MVUC8M	8	8	.60	.27	.36	.13	.25
LFPP10MVUC10M	10	10	.70	.33	.36	.13	.33
LFPP12MVUC12M	12	12	.88	.43	.36	.13	.37

NOTE: PPL refers to Polypropylene. FCB refers to Fluorocarbon.

WARNING: These products can expose you to chemicals including NICKEL, CARBON BLACK, TITANIUM DIOXIDE, or LEAD, which are known to the state of California to cause cancer or reproductive harm. For more information go to www.P65Warnings.ca.gov

[Click here for CADs, Product Specifications or to Configure Parts Online](#)

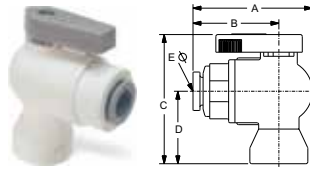

VFE - Valve Female Elbow

PART NO.	NOM. TUBE O.D.	NPTF THREAD SIZE	A	B	C	D	ØE THRU HOLE MIN.
LFPP4VFE2	1/4	1/8	1.74	1.21	1.82	.92	.19
LFPP4VFE4	1/4	1/4	1.74	1.21	2.05	1.15	.19
LFPP4VFE6	1/4	3/8	1.74	1.21	2.18	1.28	.19
LFPP6VFE2	3/8	1/8	1.85	1.32	1.82	.92	.25
LFPP6VFE4	3/8	1/4	1.85	1.32	2.05	1.15	.25
LFPP6VFE6	3/8	3/8	1.85	1.32	2.18	1.28	.25

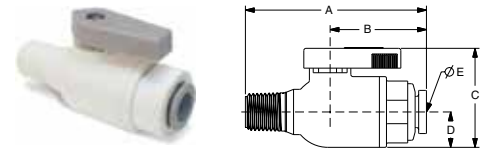

VMC - Valve Male Connector

PART NO.	NOM. TUBE O.D.	NPTF THREAD SIZE	A	B	C	D	ØE THRU HOLE MIN.
LFPP4VMC2	1/4	1/8	2.22	1.21	1.40	.50	.19
LFPP4VMC4	1/4	1/4	2.40	1.21	1.40	.50	.19
LFPP4VMC6	1/4	3/8	2.40	1.21	1.40	.50	.19
LFPP4VMC8	1/4	1/2	2.59	1.21	1.40	.50	.19
LFPP6VMC2	3/8	1/8	2.33	1.32	1.40	.50	.25
LFPP6VMC4	3/8	1/4	2.51	1.32	1.40	.50	.25
LFPP6VMC6	3/8	3/8	2.51	1.32	1.40	.50	.25
LFPP6VMC8	3/8	1/2	2.70	1.32	1.40	.50	.25
LFPP8VMC8	1/2	1/2	3.14	1.74	1.40	.50	.37

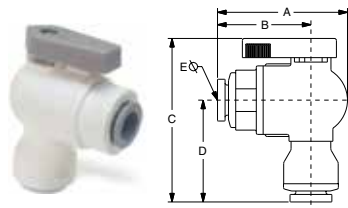

VEU - Valve Elbow Union

PART NO.	1 TUBE SIZE	2 TUBE SIZE	A	B	C	D	ØE THRU HOLE MIN.
LFPP4VEU4	1/4	1/4	1.75	1.22	2.33	1.42	.19
LFPP4VEU6	1/4	3/8	1.75	1.22	2.33	1.42	.19
LFPP6VEU4	3/8	1/4	1.83	1.30	2.32	1.40	.19
LFPP6VEU6	3/8	3/8	1.85	1.32	2.34	1.44	.25

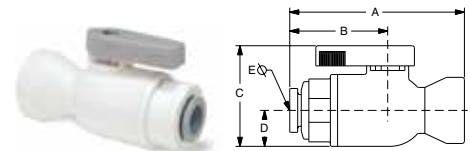

VFC - Valve Female Connector

PART NO.	NOM. TUBE O.D.	NPTF THREAD SIZE	A	B	C	D	ØE THRU HOLE MIN.
LFPP4VFC2	1/4	1/8	2.04	1.21	1.40	.50	.19
LFPP4VFC4	1/4	1/4	2.27	1.21	1.40	.50	.19
LFPP4VFC6	1/4	3/8	2.40	1.21	1.40	.50	.19
LFPP6VFC2	3/8	1/8	2.15	1.32	1.40	.50	.25
LFPP6VFC4	3/8	1/4	2.38	1.32	1.40	.50	.25
LFPP6VFC6	3/8	3/8	2.51	1.32	1.40	.50	.25

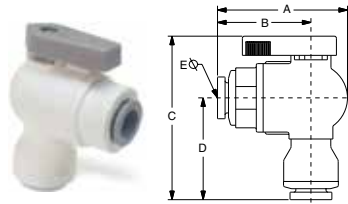

VEU - Valve Elbow Union Metric

PART NO.	1 TUBE SIZE	2 TUBE SIZE	A	B	C	D	ØE THRU HOLE MIN.
LFPP6MVEU6M	6	6	.41	.27	.55	.31	.19
LFPP8MVEU8M	8	8	.41	.28	.56	.33	.25
LFPP10MVEU10M	10	10	.48	.33	.61	.38	.33

NOTE: PPL refers to Polypropylene. FCB refers to Fluorocarbon.

WARNING These products can expose you to chemicals including NICKEL, CARBON BLACK, TITANIUM DIOXIDE, or LEAD, which are known to the state of

[Click here for CADs, Product Specifications or to Configure Parts Online](#)

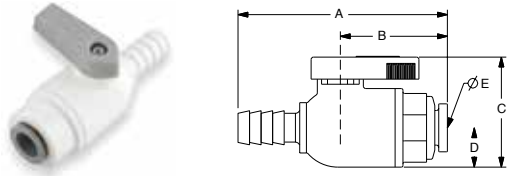

VUCPB - Valve Union Connector Barbed x Tube

PART NO.	HOSE ID	TUBE OD	OD	A	B	C	D	ØE THRU HOLE MIN.
LFPP4VUCPB4	1/4	1/4	.31	2.40	1.08	1.42	.50	.15
LFPP6VUCPB6	3/8	3/8	.43	2.63	1.32	1.42	.50	.19

BVC Ball Valve Clip

BV-Clip Shown below holding VUCPB and VME

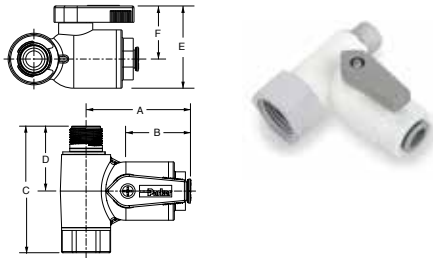
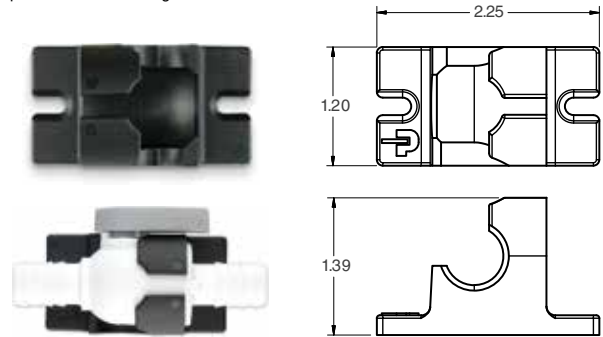

VAS - Valve Angle Stop

PART NO.	TUBE O.D.	MALE THD.	FEMALE THD.	A	B	C	D	E	F
LFPP4VAS6	1/4	3/8	3/8	1.79	1.11	2.17	1.11	1.40	.90
LFPP4VAS8	1/4	3/8	1/2	1.79	1.11	2.40	1.11	1.40	.90
LFPP6VAS6	3/8	3/8	3/8	2.03	1.35	2.17	1.11	1.40	.90
LFPP6VAS8	3/8	3/8	1/2	2.03	1.35	2.40	1.11	1.40	.90

Do not use thread sealant. Do not over tighten.

VAS Assembly Instructions:

1. Shut off water supply at brass/chrome supply valve. Disconnect riser from brass/chrome supply valve. Ensure that the sealing gasket is fully seated into the Angle Stop Valve female thread.

2. Install Angle Stop Adapter Valve on supply valve. Connect the riser to the Angle Stop Adapter Valve.

3. Fully insert tubing into the side of the valve. Open valves and check for leaks.

WARNING: These products can expose you to chemicals including NICKEL, CARBON BLACK, TITANIUM DIOXIDE, or LEAD, which are known to the state of California to cause cancer, birth defects, or other reproductive harm.

TrueSeal™ Fittings



Parker's TrueSeal Fittings are lightweight, field attachable and connect to tubing without the use of tools. These all plastic push-to-connect fittings are manufactured from FDA compliant materials.

Product Features:

- Acetal and Black Polypropylene (EPDM seals and metal gripping collet standard)
- White Polypropylene (EPDM seals and plastic gripping collet standard)
- Black Kynar (Fluorocarbon (FKM) seals and black kynar metal gripping collet standard)
- Gripping ring with stainless steel bite edge or with an engineered thermoplastic bite edge
- FDA compliant, NSF/ANSI 51
- Gray acetal NSF/ANSI 61

Markets:

- Food
- Potable Water
- Chemical
- Filtration

Applications:

- Air
- Water
- Soft Drinks
- Beer
- Wine
- Dyes

Specifications:

Pressure Range

Acetal and Kynar: 1/4", 5/16", 3/8" Vacuum to 300 PSI (20.7 bar)
1/2" Vacuum to 250 PSI (17.2 bar)

Polypropylene: 1/4", 3/8", 1/2" Vacuum to 150 PSI (10.3 bar)

*Vacuum rating to 28 inches of Hg at room temperature

Temperature Range

Acetal: -20° to +180° F (-28.9° to +82.2° C)

Polypropylene: 0° to +225° F (-17.8° to +107.2° C)

Kynar: 0° to +275° F (-17.8° to +135° C)

Compatible Tubing:

- Polyethylene
- Polypropylene**
- Nylon**
- Vinyl†
- Fluoropolymer**
- Polyurethane†
- *Kynar®

* Registered trademark of The Arkema Group.

** Metal gripper required (-MG & -HBLK suffix)

† Tube Support required.

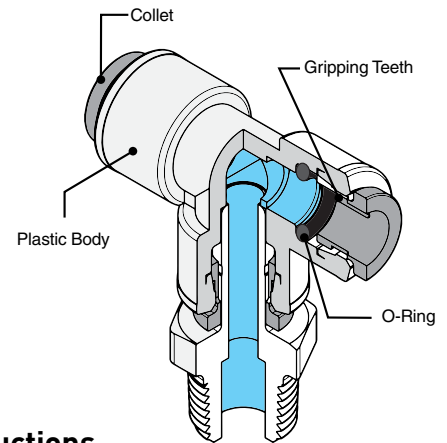

Assembly Instructions

1. Cut tubing square and clean.
(Use a Parker plastic tube cutter, Part No. PTC.)
2. Mark from end of tube length of insertion (see table below).
3. Push tube into the fitting until it bottoms out.
4. To remove, depress collet and pull tubing out.

For Threaded Connections:

5. Inspect the mating threads for debris or damage. Remove any old fluoropolymer tape or sealant on previously used threads. If threads are damaged, replace with new adapter before proceeding.
6. Apply 1 to 2 wraps of Teflon tape to the male pipe threads, or an NSF/FDA approved silicon sealant. Do not use plumbers putty or pipe dope. These chemically react with plastic materials and could cause a failure.
7. Screw together until finger tight (approximately three turns)
8. To ensure seal continue 1 to 2 more turns past finger tight.
9. Total number of turns from start to finish need not exceed 5 turns.

TUBE SIZE	O.D. TOLERANCE	INSERTION DEPTH
5/32	±.005	9/16
1/4	±.005	11/16
5/16	±.005	13/16
3/8	±.005	3/4
1/2	±.005	7/8

Threaded Fittings

MC

Male Connector
NPTF
p. B19



MES

Male Elbow Swivel
NPTF
p. B20



MRS

Male Run Tee
Swivel – NPTF
p. B20



MTS

Male Branch Tee
Swivel
NPTF
p. B21



TMC

Male Standpipe
NPTF
p. B22



ME

Male Elbow
NPTF
p. B23



FA

Faucet Adapter
UNS
p. B20



FC

Female Connector
NPTF
p. B22



FE

Female Elbow
NPTF
p. B25



ST

Straight Thread
p. B24



FF

45° Female Flare
p. B24



Tube to Tube Fittings

EU

Union Elbow
p. B19



TU

Union Tee
p. B19



WY

Union Y
p. B21



UC

Union
p. B21



CU

Cross
p. B24



Bulkhead Union

BU

Bulkhead Union
p. B22



Plug-In Fittings

TEU

Tube Elbow Union
p. B23



RD

Tube Reducer
p. B23



Check Valves

VC

Check Valve
p. B27



MCVC

Kynar Check Valve
p. B27



Accessories

CAP

Cap
p. B24



TCB

Barbed Connector
p. B24



TEB

Barbed Connector
p. B25



TPL

Plug
p. B25



TFA

Faucet Adapter
p. B24



TAF

Faucet Adapter
p. B24



SC

Safety Clip
p. B30



TS

Tube Support
p. B30



AQRT

Release Tool
p. B30



TSC

Cartridge
p. B26



Ball Valves

VME

Male Elbow
p. B28



VFE

Female Elbow
p. B28



VUC

Union Connector
p. B29



VEU

Elbow Union
p. B29



VMC

Male Connector
p. B29



VFC

Female Connector
p. B29



VTEU

Elbow Union
p. B30



[Click here for CADs, Product Specifications or to Configure Parts Online](#)

MC - Male Connector

Tube-to-Pipe

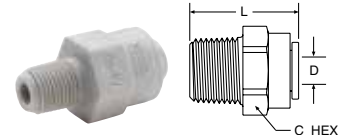

GRAY ACETAL EPDM SEAL	BLACK PPL EPDM SEAL	WHITE PPL EPDM SEAL	BLACK KYNAR FKM SEAL	NOM TUBE O. D.	NPTF THREAD SIZE	C HEX	L OVERALL LENGTH	FLOW DIA. D
A4MC2-MG	PPB4MC2-MG	PP4MC2	FB4MC2-HBLK	1/4	1/8	11/16	1.28	.175
A4MC4-MG	PPB4MC4-MG	PP4MC4	FB4MC4-HBLK	1/4	1/4	11/16	1.14	.175
A4MC6-MG	PPB4MC6-MG	PP4MC6	FB4MC6-HBLK	1/4	3/8	11/16	1.18	.175
A5MC2-MG			FB5MC2-HBLK	5/16	1/8	13/16	1.46	.175
A5MC4-MG			FB5MC4-HBLK	5/16	1/4	13/16	1.41	.188
A5MC6-MG				5/16	3/8	13/16	1.27	.188
A6MC2-MG			FB6MC2-HBLK	3/8	1/8	13/16	1.46	.175
A6MC4-MG	PPB6MC4-MG	PP6MC4	FB6MC4-HBLK	3/8	1/4	13/16	1.41	.250
A6MC6-MG	PPB6MC6-MG	PP6MC6	FB6MC6-HBLK	3/8	3/8	13/16	1.27	.250
A6MC8-MG			FB6MC8-HBLK	3/8	1/2	15/16	1.45	.250
A8MC6-MG	PPB8MC6-MG	PP8MC6	FB8MC6-HBLK	1/2	3/8	15/16	1.65	.360
A8MC8-MG	PPB8MC8-MG	PP8MC8	FB8MC8-HBLK	1/2	1/2	15/16	1.46	.375

For nonstandard plastic collet, remove -MG suffix.

EU - Elbow Union

Tube-to-Tube

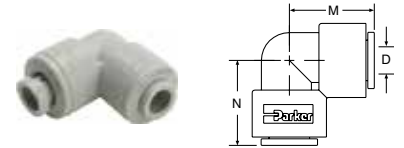

GRAY ACETAL EPDM SEAL	BLACK PPL EPDM SEAL	WHITE PPL EPDM SEAL	BLACK KYNAR FKM SEAL	NOM. TUBE O. D.	M	N	FLOW DIA. D
A4EU4-MG	PPB4EU4-MG	PP4EU4	FB4EU4-HBLK	1/4	.87	.87	.175
A5EU4-MG				5/16-1/4	1.052	.90	.175
A5EU5-MG			FB5EU5-HBLK	5/16	1.02	1.02	.188
A6EU4-MG		PP6EU4	FB6EU4-HBLK	3/8-1/4	1.02	.90	.212
A6EU5-MG				3/8-5/16	1.02	1.02	.175
A6EU6-MG	PPB6EU6-MG	PP6EU6	FB6EU6-HBLK	3/8	1.02	1.02	.250
A8EU6-MG	PPB8EU6-MG			1/2-3/8	1.20	1.20	.250
A8EU8-MG	PPB8EU8-MG	PP8EU8	FB8EU8-HBLK	1/2	1.20	1.20	.375

For nonstandard plastic collet, remove -MG suffix.

TU - Tee Union

Tube-to-Tube

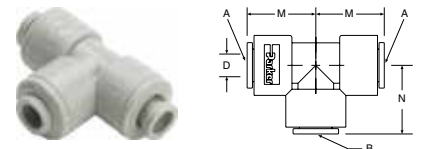

GRAY ACETAL EPDM SEAL	BLACK PPL EPDM SEAL	WHITE PPL EPDM SEAL	BLACK KYNAR FKM SEAL	NOM. TUBE O. D.		M	N	FLOW DIA. D
				TUBE A RUN	TUBE B STEM			
A4TU4-MG	PPB4TU4-MG	PP4TU4	FB4TU4-HBLK	1/4	1/4	.81	.85	.175
A5TU5-MG			FB5TU5-HBLK	5/16	5/16	1.02	1.02	.188
A6TU4-MG	PPB6TU4-MG	PP6TU4	FB6TU4-HBLK	3/8	1/4	1.02	1.03	.175
A6TU6-MG	PPB6TU6-MG	PP6TU6	FB6TU6-HBLK	3/8	3/8	1.02	1.02	.290
A8TU8-MG	PPB8TU8-MG	PP8TU8	FB8TU8-HBLK	1/2	1/2	1.20	1.20	.375

For nonstandard plastic collet, remove -MG suffix.

FA - Faucet Adapter

Tube-to-Faucet

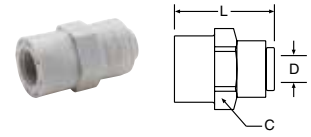

GRAY ACETAL EPDM SEAL	BLACK PPL EPDM SEAL	WHITE PPL EPDM SEAL	BLACK KYNAR FKM SEAL	NOM. TUBE O.D.	UNS-2B THREAD SIZE	C HEX	L OVERALL LENGTH	FLOW DIA. D
A4FA7-MG	PPB4FA7-MG	PP4FA7	FB4FA7-HBLK	1/4	7/16-24	23/32	1.32	.190
A5FA7-MG				5/16	7/16-24	13/16	1.41	.190
A6FA7-MG	PPB6FA7-MG	PP6FA7	FB6FA7-HBLK	3/8	7/16-24	13/16	1.41	.190

For nonstandard plastic collet, remove -MG suffix.

MES - Male Elbow Swivel

Tube-to-Pipe

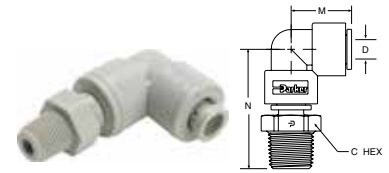

GRAY ACETAL EPDM SEAL	BLACK PPL EPDM SEAL	WHITE PPL EPDM SEAL	BLACK KYNAR FKM SEAL	NOM. TUBE O.D.	NPTF THREAD SIZE	C HEX	M	N	FLOW DIA. D
A4MES2-MG	PPB4MES2-MG	PP4MES2	FB4MES2-HBLK	1/4	1/8	9/16	.87	1.60	.175
A4MES4-MG	PPB4MES4-MG	PP4MES4	FB4MES4-HBLK	1/4	1/4	11/16	.87	1.71	.175
A4MES6-MG		PP4MES6	FB4MES6-HBLK	1/4	3/8	13/16	.90	1.91	.212
A5MES2-MG				5/16	1/8	9/16	1.02	1.78	.188
A5MES4-MG				5/16	1/4	11/16	1.02	1.90	.188
A5MES6-MG				5/16	3/8	13/16	1.02	1.90	.188
A6MES2-MG			FB6MES2-HBLK	3/8	1/8	9/16	1.02	1.65	.175
A6MES4-MG	PPB6MES4-MG	PP6MES4	FB6MES4-HBLK	3/8	1/4	13/16	1.02	1.90	.250
A6MES6-MG	PPB6MES6-MG	PP6MES6	FB6MES6-HBLK	3/8	3/8	13/16	1.02	1.90	.250
A8MES4-MG				1/2	1/4	13/16	1.20	2.10	.240
A8MES6-MG		PP8MES6		1/2	3/8	13/16	1.20	2.10	.375
A8MES8-MG		PP8MES8		1/2	1/2	1	1.20	2.32	.375

* Part consists of elbow union and tube stem adaptor.

Note: Assemblies with metal gripper collets are permanent. Assemblies with plastic collets can be taken apart.

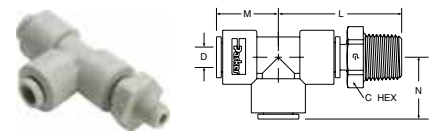

MRS - Male Run Tee Swivel

Tube-to-Pipe

GRAY ACETAL EPDM SEAL	BLACK PPL EPDM SEAL	WHITE PPL EPDM SEAL	BLACK KYNAR FKM SEAL	NOM. TUBE O.D.	NPTF THREAD SIZE	C HEX	L	M	N	D THRU HOLE MIN.
A4MRS2-MG	PPB4MRS2	PP4MRS2	FB4MRS2-HBLK	1/4	1/8	9/16	1.55	.81	0.85	.175
A4MRS4-MG	PPB4MRS4-MG	PP4MRS4	FB4MRS4-HBLK	1/4	1/4	11/16	1.67	.81	0.85	.175
A5MRS2-MG				5/16	1/8	9/16	1.78	1.02	1.02	.188
A5MRS4-MG				5/16	1/4	11/16	1.90	1.02	1.02	.188
A5MRS6-MG				5/16	3/8	13/16	1.90	1.02	1.02	.188
A6MRS4-MG	PPB6MRS4-MG	PP6MRS4	FB6MRS4-HBLK	3/8	1/4	13/16	1.90	1.02	1.02	.250
A6MRS6-MG	PPB6MRS6-MG	PP6MRS6	FB6MRS6-HBLK	3/8	3/8	13/16	1.90	1.02	1.02	.250
A8MRS4-MG				1/2	1/4	13/16	2.10	1.20	1.20	.240
A8MRS6-MG		PP8MRS6		1/2	3/8	13/16	2.10	1.20	1.20	.375
A8MRS8-MG		PP8MRS8		1/2	1/2	1	2.32	1.20	1.20	.375

*Part consists of tee union and tube stem adaptor.

Note: Assemblies with metal gripper collets are permanent. Assemblies with plastic collets can be taken apart.

[Click here for CADs, Product Specifications or to Configure Parts Online](#)

MTS - Male Tee Swivel

Tube-to-Pipe

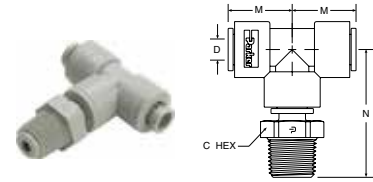

GRAY ACETAL EPDM SEAL	BLACK PPL EPDM SEAL	WHITE PPL EPDM SEAL	BLACK KYNAR FKM SEAL	NOM. TUBE O. D.	NPTF THREAD SIZE	C HEX	M	N	FLOW DIA. D
A4MTS2-MG	PPB4MTS2	PP4MTS2	FB4MTS2-HBLK	1/4	1/8	9/16	.81	1.60	.175
A4MTS4-MG	PPB4MTS4-MG	PP4MTS4	FB4MTS4-HBLK	1/4	1/4	11/16	.81	1.71	.175
A5MTS2-MG				5/16	1/8	9/16	1.02	1.78	.188
A5MTS4-MG				5/16	1/4	11/16	1.02	1.90	.188
A5MTS6-MG				5/16	3/8	13/16	1.02	1.90	.188
A6MTS2-MG			FB6MTS2-HBLK	3/8	1/8	9/16	1.02	1.75	.175
A6MTS4-MG	PPB6MTS4-MG	PP6MTS4	FB6MTS4-HBLK	3/8	1/4	13/16	1.02	1.90	.250
A6MTS6-MG	PPB6MTS6-MG	PP6MTS6	FB6MTS6-HBLK	3/8	3/8	13/16	1.02	1.90	.250
A8MTS4-MG				1/2	1/4	13/16	1.20	2.10	.240
A8MTS6-MG		PP8MTS6		1/2	3/8	13/16	1.20	2.10	.375
A8MTS8-MG		PP8MTS8		1/2	1/2	1	1.20	2.32	.375

* Part consists of tee union and tube stem adaptor.
 Note: Assemblies with metal gripper collets are permanent. Assemblies with plastic collets can be taken apart.

UC - Union Connector

Tube-to-Tube

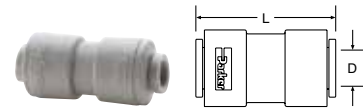

GRAY ACETAL EPDM SEAL	BLACK PPL EPDM SEAL	WHITE PPL EPDM SEAL	BLACK KYNAR FKM SEAL	NOM. TUBE O. D.	L OVERALL LENGTH	FLOW DIA. D
A4UC4-MG	PPB4UC4-MG	PP4UC4	FB4UC4-HBLK	1/4	1.49	.175
A5UC4-MG				5/16-1/4	1.70	.175
A5UC5-MG			FB5UC5-HBLK	5/16	1.70	.188
A6UC4-MG	PPB6UC4-MG	PP6UC4	FB6UC4-HBLK	3/8-1/4	1.70	.175
A6UC5-MG				3/8-5/16	1.70	.188
A6UC6-MG	PPB6UC6-MG	PP6UC6	FB6UC6-HBLK	3/8	1.70	.250
A8UC5-MG				1/2-5/16	1.90	.188
A8UC6-MG	PPB8UC6-MG	PP8UC6	FB8UC6-HBLK	1/2-3/8	1.90	.250
A8UC8-MG	PPB8UC8-MG	PP8UC8	FB8UC8-HBLK	1/2	1.91	.375

For nonstandard plastic collet, remove -MG suffix.

WY - "Y" Union

Tube-to-Tube

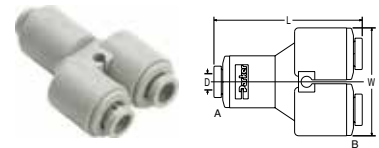

GRAY ACETAL EPDM SEAL	WHITE PPL EPDM SEAL	BLACK KYNAR FKM SEAL	NOM. TUBE O. D.		L	W	FLOW DIA. D
			INLET TUBE A RUN	OUTLET TUBE B STEM			
		FB4WY4-HBLK	1/4	1/4	2.100	1.43	.190
A5WY5-MG		FB5WY5-HBLK	5/16	5/16	2.250	1.75	.190
A6WY4-MG		FB6WY4-HBLK	3/8	1/4	2.100	1.43	.190
A6WY5-MG			3/8	5/16	2.200	1.75	.190
A6WY6-MG		FB6WY6-HBLK	3/8	3/8	2.175	1.75	.250
		FB8WY6-HBLK	1/2	3/8	2.370	1.93	.250
		FB8WY8-HBLK	1/2	1/2	2.370	1.93	.380

[Click here for CADs, Product Specifications or to Configure Parts Online](#)

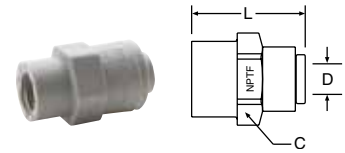

FC - Female Connector

Tube-to-Pipe

GRAY ACETAL EPDM SEAL	BLACK PPL EPDM SEAL	WHITE PPL EPDM SEAL	BLACK KYNAR FKM SEAL	NOM. TUBE O.D.	NPTF THREAD SIZE	C HEX	L OVERALL LENGTH	FLOW DIA. D
A4FC2-MG	PPB4FC2-MG	PP4FC2	FB4FC2-HBLK	1/4	1/8	11/16	1.20	.175
A4FC4-MG	PPB4FC4-MG	PP4FC4	FB4FC4-HBLK	1/4	1/4	23/32	1.32	.175
A5FC4-MG			FB5FC4-HBLK	5/16	1/4	13/16	1.41	.188
A5FC6-MG				5/16	3/8	1	1.50	.188
A6FC4-MG	PPB6FC4-MG	PP6FC4	FB6FC4-HBLK	3/8	1/4	13/16	1.41	.250
A6FC6-MG	PPB6FC6-MG	PP6FC6	FB6FC6-HBLK	3/8	3/8	1	1.50	.250
A6FC8-MG			FB6FC8-HBLK	3/8	1/2	1-1/8	1.52	.250
A8FC6-MG		PP8FC6	FB8FC6-HBLK	1/2	3/8	1-1/8	1.60	.375
A8FC8-MG		PP8FC8	FB8FC8-HBLK	1/2	1/2	1-1/8	1.75	.375

For nonstandard plastic collet, remove -MG suffix.

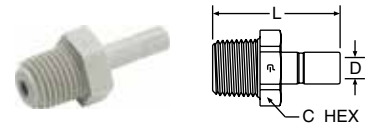

TMC - Tube Stem Adapter

Tube Stem-to-Pipe

GRAY ACETAL EPDM SEAL	BLACK PPL EPDM SEAL	WHITE PPL EPDM SEAL	BLACK KYNAR FKM SEAL	NOM. TUBE O.D.	NPTF THREAD SIZE	C HEX	L OVERALL LENGTH	FLOW DIA. D
A4TMC2	PPB4TMC2	PP4TMC2	FB4TMC2	1/4	1/8	9/16	1.44	.175
A4TMC4	PPB4TMC4	PP4TMC4	FB4TMC4	1/4	1/4	11/16	1.56	.175
A5TMC2				5/16	1/8	9/16	1.5	.188
A5TMC4			FB5TMC4	5/16	1/4	11/16	1.67	.188
A5TMC6				5/16	3/8	13/16	1.67	.188
A6TMC4	PPB6TMC4	PP6TMC4	FB6TMC4	3/8	1/4	13/16	1.70	.250
A6TMC6	PPB6TMC6	PP6TMC6	FB6TMC6	3/8	3/8	13/16	1.70	.250
A8TMC4				1/2	1/4	13/16	1.82	.240
A8TMC6		PP8TMC6	FB8TMC6	1/2	3/8	13/16	1.82	.375
A8TMC8		PP8TMC8	FB8TMC8	1/2	1/2	1	2.04	.375

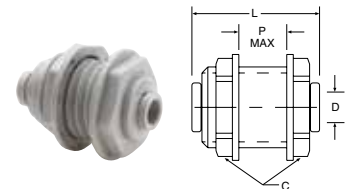

BU - Bulkhead Union

Tube-to-Tube

GRAY ACETAL EPDM SEAL	BLACK PPL EPDM SEAL	WHITE PPL EPDM SEAL	BLACK KYNAR FKM SEAL	NOM. TUBE O.D.	C1 HEX	C2 HEX	L OVERALL LENGTH	P MAX. WALL THICKNESS	FLOW DIA. D	BKHD HOLE DRILL SIZE
A4BU4-MG	PPB4BU4-MG	PP4BU4	FB4BU4-HBLK	1/4	15/16	15/16	1.50	.50	.175	7/8
A5BU5-MG			FB5BU5-HBLK	5/16	1-1/16	1-1/16	1.75	.62	.188	1
A6BU4-MG	PPB6BU4-MG	PP6BU4	FB6BU4-HBLK	3/8-1/4	1-1/16	1-1/16	1.75	.62	.175	1
A6BU6-MG	PPB6BU6-MG	PP6BU6	FB6BU6-HBLK	3/8	1-1/16	1-1/16	1.75	.62	.250	1
A8BU8-MG			FB8BU8-HBLK	1/2	1-1/4	1-1/4	2.04	.70	.375	1-1/8

For nonstandard plastic collet, remove -MG suffix.

[Click here for CADs, Product Specifications or to Configure Parts Online](#)

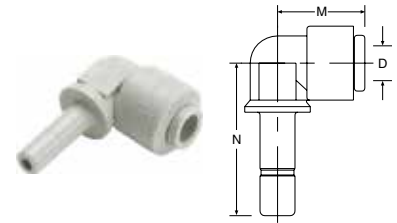

TEU - Tube Elbow Union

Tube-to-Tube Stem

GRAY ACETAL EPDM SEAL	BLACK PPL EPDM SEAL	WHITE PPL EPDM SEAL	BLACK KYNAR FKM SEAL	NOM. TUBE O. D.	TUBE STEM O. D.	M	N	FLOW DIA. D
A4TEU4-MG	PPB4TEU4-MG	PP4TEU4	FB4TEU4-HBLK	1/4	1/4	.84	1.21	.125
A4TEU6-MG			FB4TEU6-HBLK	1/4	3/8	.84	1.35	.125
A5TEU5-MG			FB5TEU5-HBLK	5/16	5/16	1.03	1.40	.188
A6TEU4-MG			FB6TEU4-HBLK	3/8	1/4	1.03	1.29	.125
A6TEU6-MG	PPB6TEU6	PP6TEU6	FB6TEU6-HBLK	3/8	3/8	1.03	1.64	.250
A8TEU8-MG	PPB8TEU8-MG	PP8TEU8	FB8TEU8-HBLK	1/2	1/2	1.21	1.64	.380

For nonstandard plastic collet, remove -MG suffix.

RD - Tube Reducer

Tube-to-Tube Stem

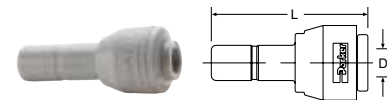

GRAY ACETAL EPDM SEAL	BLACK PPL EPDM SEAL	WHITE PPL EPDM SEAL	BLACK KYNAR FKM SEAL	NOM. TUBE O. D.	TUBE STEM O. D.	L	FLOW DIA. D
A4RD5-MG		PP4RD5		1/4	5/16	1.62	.18
A4RD6-MG	PPB4RD6-MG	PP4RD6	FB4RD6-HBLK	1/4	3/8	1.62	.18
A5RD6-MG				5/16	3/8	1.78	.25
A5RD8-MG				5/16	1/2	1.90	.25
A6RD8-MG			FB6RD8-HBLK	3/8	1/2	1.90	.25

For nonstandard plastic collet, remove -MG suffix.

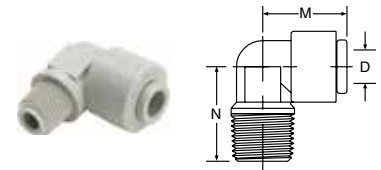

ME - Male Elbow

Tube-to-Pipe

GRAY ACETAL EPDM SEAL	BLACK PPL EPDM SEAL	WHITE PPL EPDM SEAL	BLACK KYNAR FKM SEAL	NOM. TUBE O. D.	NPTF THREAD SIZE	M	N	FLOW DIA. D
A4ME2-MG	PPB4ME2-MG	PP4ME2	FB4ME2-HBLK	1/4	1/8	.84	.94	.175
A4ME4-MG	PPB4ME4-MG	PP4ME4	FB4ME4-HBLK	1/4	1/4	.84	.94	.175
A4ME6-MG	PPB4ME6-MG	PP4ME6	FB4ME6-HBLK	1/4	3/8	.84	1.04	.175
A5ME4-MG			FB5ME4-HBLK	5/16	1/4	1.03	1.08	.175
A5ME6-MG				5/16	3/8	1.03	1.06	.188
A6ME4-MG		PP6ME4	FB6ME4-HBLK	3/8	1/4	1.03	1.08	.250
A6ME6-MG	PPB6ME6-MG	PP6ME6	FB6ME6-HBLK	3/8	3/8	1.03	1.06	.250

For nonstandard plastic collet, remove -MG suffix.

[Click here for CADs, Product Specifications or to Configure Parts Online](#)

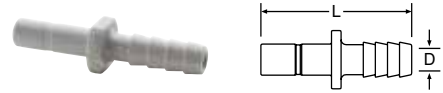

TCB - Tube-to-Barb Connector

GRAY ACETAL	BLACK PPL EPDM SEAL	WHITE POLYPROPYLENE	BLACK KYNAR FKM SEAL	TUBE STEM O.D.	TUBE I.D.	L OVERALL LENGTH	FLOW DIA. D
A4TCB4		PP4TCB4	FB4TCB4	1/4	1/4	1.67	.140
A6TCB4			FB6TCB4	3/8	1/4	1.82	.140
A6TCB6	PP6TCB6	PP6TCB6	FB6TCB6	3/8	3/8	1.98	.250
A8TCB6				1/2	3/8	2.10	.250
A8TCB8			FB8TCB8	1/2	1/2	2.10	.375

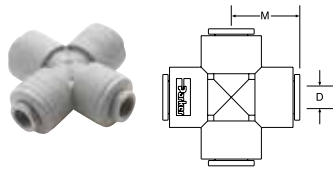

CU - Cross Union

Tube-to-Tube

GRAY ACETAL EPDM SEAL	WHITE PPL EPDM SEAL	BLACK KYNAR FCB SEAL	NOM. TUBE O.D.	M	FLOW DIA. D
A4CU4-MG			1/4	.91	.175
A6CU6-MG			3/8	1.08	.250

For nonstandard plastic collet, remove -MG suffix.

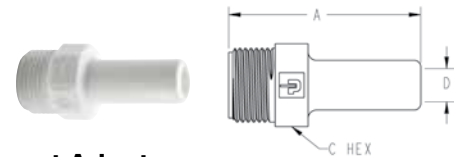

TAF - Tube Faucet Adapter

(Male Thread)

WHITE ACETAL	TUBE STEM O.D.	THREAD SIZE	A	C HEX	D MIN.
AW6TAF7-MG	3/8	7/16-24	1.41	.50	.22
AW6TAF8-MG	3/8	1/2-14 NPSM	1.65	.88	.22
AW6TAF9-MG	3/8	9/16-24	1.45	.63	.22

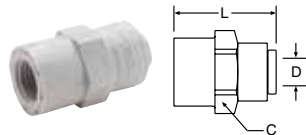

FF - 45° Female Flare

Tube-to-Flare

GRAY ACETAL EPDM SEAL	WHITE PPL EPDM SEAL	BLACK KYNAR FKM SEAL	NOM. TUBE O.D.	UNF-2B THREAD SIZE	C HEX	L OVERALL LENGTH	FLOW DIA. D
A4FF4-MG	PP4FF4	FB4FF4-HBLK	1/4	7/16-20	23/32	1.32	.190
A6FF4-MG		FB6FF4-HBLK	3/8	7/16-20	13/16	1.41	.190
A6FF6-MG	PP6FF6	FB6FF6-HBLK	3/8	5/8-18	1	1.50	.250

For nonstandard plastic collet, remove -MG suffix.

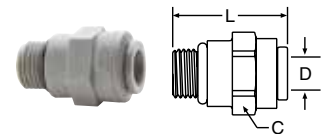

ST - Straight Thread

Tube-to-Male O-Ring Boss

GRAY ACETAL EPDM SEAL	WHITE PPL EPDM SEAL	BLACK KYNAR FKM SEAL	NOM. TUBE O.D.	UNF-2B THD SIZE	C HEX	L OVERALL LENGTH	FLOW DIA. D
A6ST9-MG		FB6ST9-HBLK	3/8	9/16-18	13/16	1.39	.250

For nonstandard plastic collet, remove -MG suffix.

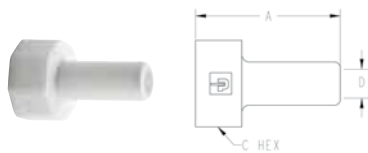

TFA - Tube Faucet Adapter

(Female Thread)

WHITE ACETAL	TUBE STEM O.D.	THREAD SIZE	A	C HEX	D MIN.
AW6TFA7-MG	3/8	7/16-24	1.25	.69	.17
AW6TFA8-MG	3/8	1/2-14 NPSM	1.45	1.06	.22
AW6TFA9-MG	3/8	9/16-24	1.25	.75	.22

CAP - Tube Cap

GRAY ACETAL EPDM SEAL	WHITE PPL EPDM SEAL	NATURAL KYNAR FKM SEAL	NOM. TUBE O.D.	L OVERALL LENGTH
A4CAP-MG	PP4CAP	FB4CAP-HBLK	1/4	.77
A6CAP-MG	PP6CAP		3/8	0.88

For nonstandard plastic collet, remove -MG suffix.

[Click here for CADs, Product Specifications or to Configure Parts Online](#)

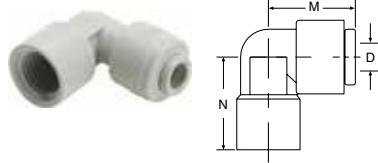

FE - Female Elbow

Tube-to-Pipe

GRAY ACETAL EPDM SEAL	WHITE PPL EPDM SEAL	BLACK KYNAR FKIM SEAL	NOM. TUBE O.D.	NPTF THREAD SIZE	M	N	FLOW DIA. D
A4FE4-MG			1/4	1/4	.84	1.00	.18
A6FE4-MG			3/8	1/4	1.03	1.00	.25
A6FE6-MG			3/8	3/8	1.03	1.00	.25

For nonstandard plastic collet, remove -MG suffix.

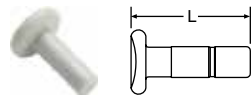

TPL - Plug

GRAY ACETAL	BLACK PPL	WHITE PPL	BLACK KYNAR	FITTING SIZE	L OVERALL LENGTH
A4TPL	PPB4TPL	PP4TPL	FB4TPL	1/4	0.88
A6TPL	PPB6TPL-MG	PP6TPL	FB6TPL	3/8	1.45
A8TPL	PPB8TPL	PP8TPL		1/2	1.50



TEB - Tube Elbow Barb Connector

GRAY ACETAL	WHITE POLYPROPYLENE	BLACK KYNAR	TUBE STEM O.D.	TUBE I.D.	M	N	FLOW DIA. D
A4TEB4	PP4TEB4	FB4TEB4	1/4	1/4	.89	1.00	.140
A6TEB4	PP6TEB4	FB6TEB4	3/8	1/4	1.335	1.055	.375
A6TEB6	PP6TEB6	FB6TEB6	3/8	3/8	1.34	1.21	.250
A8TEB8			1/2	1/2	1.30	1.30	.390



TSC - Cartridge Insert

PART NO. WITH EPDM SEAL	NOM. TUBE O.D.	A* DIAMETER ±002	B DIAMETER ±003	C DIAMETER ±003	D DIAMETER MAXIMUM	E DEPTH ±002	F DEPTH ±002	G DEPTH ±002	H* CENTERLINE OF PORTS MINIMUM
ATSC4-MG	1/4	.528	.421	.260	.19	.230	.435	.600	.670
ATSC6-MG	3/8	.632	.545	.385	.31	.280	.455	.705	.790
ATSC8-MG	1/2	.774	.668	.510	.41	.315	.510	.810	1.250

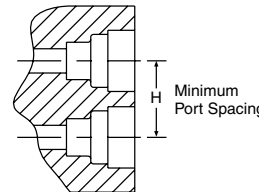
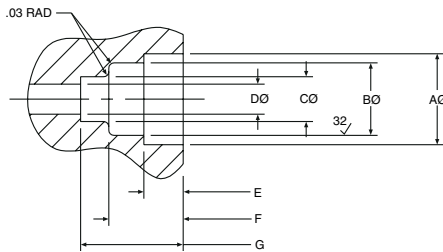

Parker TrueSeal™ Cartridge Inserts:

Allow you to machine or mold a tube connection into your equipment or components. By using cartridge inserts, you will reduce your material and assembly costs, reduce potential leak paths, and give your equipment a new, clean profile by eliminating the need for threaded connections. TSC Cartridge Inserts consist of 1 o-ring, 1 cartridge, and 1 collet.

*Cartridge inserts are rated at 150 PSI in ports dimensioned as above and having Noryl as the receiving material. Other materials may have different ratings and require different port dimensions. Consult the Fluid System Connectors Division when using polypropylene, unfilled polypropylene, ABS or Nylon.

NORYL® is a registered trademark of the General Electric Co.

Assembly Instructions:

1. Machine or mold the receiving orifice as per the above dimensions.
2. Place the cartridge insert squarely onto the prepared port opening making sure that the barbs of the cartridge are going into the hole and the lettering on the face of the cartridge is visible.
3. Using a rubber mallet or press, insert the cartridge into the first gland orifice until its face is flush with the top surface of the port.
4. Insert the o-ring into the cartridge and seat it evenly into the second gland orifice.
5. Insert the collet into the cartridge opening.
6. Insert tubing.

[Click here for CADs, Product Specifications or to Configure Parts Online](#)

TrueSeal Check Valves

Push-to-Connect check valves that ensures protection against reversal of flow. The valves have an arrow molded into the body to indicate the direction of flow. Valves are designed for connection with either thermoplastic or soft metal tubing and are intended for use with liquids only.

Materials of Construction

Body	Acetal
O-ring	EPDM
Metal Grip Edge	300 Stainless
Working Pressure	Up to 150 PSI (10.3 bar) depending on tubing being used
Temperature Range	+34° to +150° F (+1° to +65° C)
Cracking Pressure	1/3 PSI (0.02 bar)

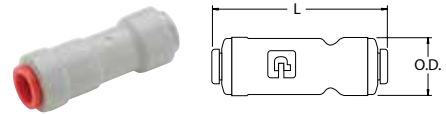

VC – Check Valve

PART NO.	TUBE SIZE	L	O.D.
A4VC4-MG	1/4	2.00	.66
A5VC5-MG	5/16	2.10	.70
A6VC6-MG	3/8	2.15	.80
A8VC8-MG	1/2	2.68	.91

PVDF Check Valves

Materials of Construction

Body	Kynar®
O-ring	Fluorocarbon
Metal Grip Edge	Stainless Steel
Working Pressure	Up to 300 PSI (20.7 bar)
Temperature Range	0° to +250° F (-17.8° to +121° C)



MCVC Kynar® Check Valves

PART NO.	TUBE O.D.	NPTF THREAD	L	C HEX	CRACKING PRESSURE PSI
FB6MCVC4-HBLK-05	3/8	1/4	1.40	13/16	.5
FB6MCVC4-HBLU-15	3/8	1/4	1.40	13/16	1.5
FB6MCVC4-HRED-30	3/8	1/4	1.40	13/16	3.0
FB6MCVC4-HGRN-40	3/8	1/4	1.40	13/16	4.0

Note: For check valve to function properly tubing needs to be installed

Polypropylene Ball Valves

For proven leak-free performance, specify Polypropylene Ball Valves. Their corrosion-resistant, all-plastic design makes them ideal for water filtration units, coffee and beverage machines and a wide variety of other fluid applications. Polypropylene material meets all FDA and NSF-51 requirements for food contact.

Features/Benefits:

- Precision molded, all-plastic design is leak free and corrosion resistant.
- Polypropylene material offers a wider chemical acceptance range, as well as a wide temperature range.
- Bi-directional flow maximizes productivity.
- Full flow design reduces pressure drop across the valve.
- Special o-ring seal ensures a reliable leak-tight connection.
- TrueSeal™ connection reduces potential leaks.

Specifications:

- Temperature range: +35° to +200°F (+2° to +93°C)
- O-ring seal material: EPDM
- NSF/ANSI 51 AND 61
- Pressure rated to 150 PSI (10.3 bar). Actual working pressures will be lower at elevated temperatures

Advantages:

- Reduce costs—Built-in TrueSeal™ connection eliminates the need for a secondary fitting.
- Save space—Low-profile design allows for easy assembly and access where space is at a premium.

VME - Valve Male Elbow

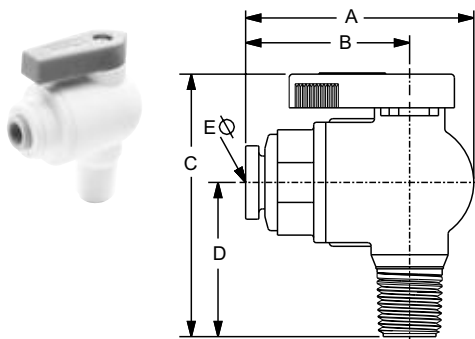

PART NO.	NOM. TUBE O.D.	NPTF THREAD SIZE	A	B	C	D	ØE THRU HOLE MIN.
PP4VME2-MG (+)	1/4	1/8	1.74	1.21	2.00	1.10	.19
PP4VME4-MG	1/4	1/4	1.74	1.21	2.18	1.28	.19
PP4VME6-MG	1/4	3/8	1.74	1.21	2.18	1.28	.19
PP4VME8-MG (+)	1/4	1/2	1.74	1.21	2.37	1.47	.19
PP6VME2-MG (+)	3/8	1/8	1.85	1.32	2.00	1.10	.25
PP6VME4-MG	3/8	1/4	1.85	1.32	2.18	1.28	.25
PP6VME6-MG	3/8	3/8	1.85	1.32	2.18	1.28	.25
PP6VME8-MG	3/8	1/2	1.85	1.32	2.37	1.47	.25

VFE - Valve Female Elbow

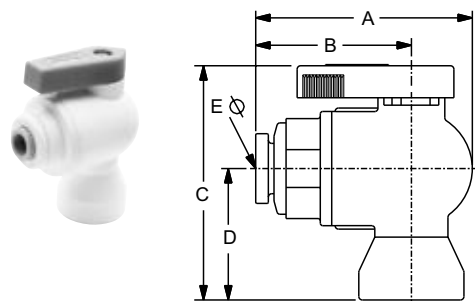

PART NO.	NOM. TUBE O.D.	NPTF THREAD SIZE	A	B	C	D	ØE THRU HOLE MIN.
PP4VFE2-MG (+)	1/4	1/8	1.74	1.21	1.82	.92	.19
PP4VFE4-MG	1/4	1/4	1.74	1.21	2.05	1.15	.19
PP4VFE6-MG	1/4	3/8	1.74	1.21	2.18	1.28	.19
PP6VFE2-MG (+)	3/8	1/8	1.85	1.32	1.82	.92	.25
PP6VFE4-MG	3/8	1/4	1.85	1.32	2.05	1.15	.25
PP6VFE6-MG	3/8	3/8	1.85	1.32	2.18	1.28	.25

(+) Non Standard.

[Click here for CADs, Product Specifications or to Configure Parts Online](#)

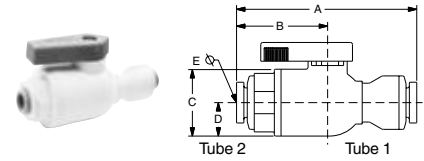

VUC - Valve Union Connector

BLACK POLYPROPYLENE	WHITE POLYPROPYLENE	1 TUBE SIZE	2 TUBE SIZE	A	B	C	D	ØE THRU HOLE MIN.
PPB4VUC4-MG	PP4VUC4-MG	1/4	1/4	2.55	1.22	1.0	.5	.19
	PP4VUC6-MG	1/4	3/8	2.55	1.22	1.0	.5	.19
	PP6VUC4-MG	3/8	1/4	2.57	1.30	1.0	.5	.19
PPB6VUC6-MG	PP6VUC6-MG	3/8	3/8	2.67	1.32	1.4	.5	.25

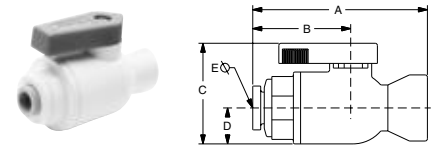

VFC - Valve Female Connector

BLACK POLYPROPYLENE	WHITE POLYPROPYLENE	NOM. TUBE O.D.	NPTF THREAD SIZE	A	B	C	D	ØE THRU HOLE MIN.
	PP4VFC2-MG	1/4	1/8	2.04	1.21	1.4	.5	.19
	PP4VFC4-MG	1/4	1/4	2.27	1.21	1.4	.5	.19
	PP4VFC6-MG	1/4	3/8	2.40	1.21	1.4	.5	.19
	PP6VFC2-MG	3/8	1/8	2.15	1.32	1.4	.5	.25
	PP6VFC4-MG	3/8	1/4	2.38	1.32	1.4	.5	.25
PPB6VFC6-MG	PP6VFC6-MG	3/8	3/8	2.51	1.32	1.4	.5	.25

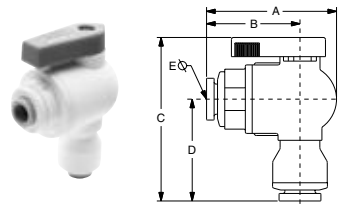

VEU - Valve Elbow Union

PART NO.	1 TUBE SIZE	2 TUBE SIZE	A	B	C	D	ØE THRU HOLE MIN.
PP4VEU4-MG	1/4	1/4	1.75	1.22	2.33	1.42	.19
PP4VEU6-MG	1/4	3/8	1.75	1.22	2.33	1.42	.11
PP6VEU4-MG	3/8	1/4	1.83	1.30	2.32	1.40	.19
PP6VEU6-MG	3/8	3/8	1.85	1.32	2.34	1.44	.25

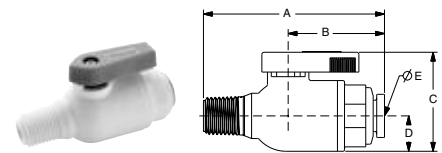

VMC - Valve Male Connector

PART NO.	NOM. TUBE O.D.	NPTF THREAD SIZE	A	B	C	D	ØE THRU HOLE MIN.
PP4VMC2-MG (+)	1/4	1/8	2.22	1.21	1.4	.5	.19
PP4VMC4-MG	1/4	1/4	2.40	1.21	1.4	.5	.19
PP4VMC6-MG	1/4	3/8	2.40	1.21	1.4	.5	.19
PP4VMC8-MG (+)	1/4	1/2	2.59	1.21	1.4	.5	.19
PP6VMC2-MG (+)	3/8	1/8	2.33	1.32	1.4	.5	.25
PP6VMC4-MG	3/8	1/4	2.51	1.32	1.4	.5	.25
PP6VMC6-MG	3/8	3/8	2.51	1.32	1.4	.5	.25
PP6VMC8-MG (+)	3/8	1/2	2.70	1.32	1.4	.5	.25

Click here for CADs, Product Specifications or to Configure Parts Online

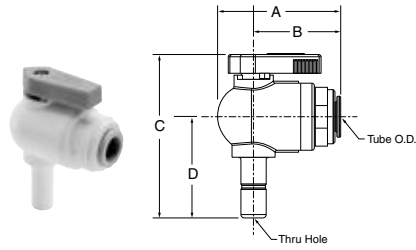

VTEU - Valve Tube Elbow Union

PART NO.	NOM. TUBE O.D.	STEM	A	B	C	D	ØE THRU HOLE MIN.
PP4VTEU6-MG	1/4	3/8	1.75	1.22	2.43	1.50	.17
PP6VTEU6-MG	3/8	3/8	1.83	1.30	2.43	1.50	.25



TS - Tube Supports

NYLON PART NO.	PPL PART NUMBER
N4TS3	P4TS3
N5TS3	P5TS3
N6TS4	P6TS4
N8TS6	P8TS6

To be used with soft durometer tubing.



SC - Safety Clip

(Patent No. 6,065,779)

PART NO.	PART NO.	FOR NOMINAL TUBE O.D.
SC-4	SC-4-B	1/4
SC-5	SC-5-B	5/16
SC-6	SC-6-B	3/8
SC-8	SC-8-B	1/2

AQRT - Quick Release Tool

Makes disconnection of tube adapters and tubing a breeze.



Fast & Tite® Fittings



Parker's Fast & Tite Fittings are a compression style fitting that installs in seconds without tools and provides a tight, sure, leak proof seal without clamps or adjustments. A unique grab ring for tube retention, coupled with a Nitrile o-ring creates a positive seal and assures good tube retention with only hand tight assembly.

Product Features:

- Available in white polypropylene, black polypropylene and white nylon
- 302 stainless steel grab ring
- Nitrile O-ring
- FDA compliant material
- NSF/ANSI-51

Markets:

- Water Filtration
- Beverage Dispensing
- Life Science
- Bottling
- Semi-Conductor

Applications:

- Water
- Beverages
- Food
- Cooling Systems

Compatible Tubing:

- Thermoplastic
- Soft Metal
- Glass

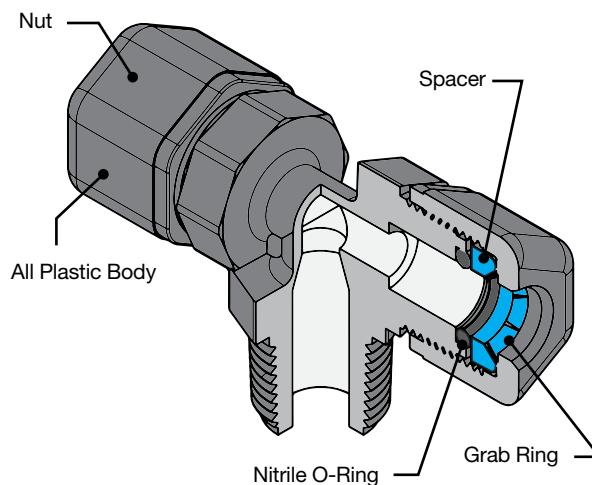

Specifications:

Air-Oil-Water Pressure in PSI (bar)

TUBE O. D. IN.	UP TO 75° F	76° TO 125° F	126° TO 175° F
1/4	300 (20.7)	300 (20.7)	300 (20.7)
5/16	300 (20.7)	300 (20.7)	300 (20.7)
3/8	250 (17.2)	250 (17.2)	150 (10.3)
1/2	200 (13.8)	200 (13.8)	150 (10.3)
5/8	150 (10.3)	100 (6.9)	50 (3.5)

Temperature Range

Nylon: -40° to +200° F (-40° to +93.3° C)

Polypropylene: 0° to +212° F (-17.8° to +100° C)

TUBE O. D. (IN.)	INSERTION LENGTH
1/4	5/8
5/16	5/8
3/8	13/16
1/2	7/8
5/8	1

Assembly Instructions

1. Cut the tube squarely and remove any burrs.
2. Mark from end of tube the length of insertion. If using a tube support, insert fully into tube before marking. (See insertion length table left)
3. Loosen nut on fitting until three threads are visible. Fittings for glass tubes must be disassembled and the grab ring removed. If the fitting has been disassembled the components are to be placed in the following order: fitting body, o-ring, spacer, grab ring and nut. Assemble the nut until three threads are showing on the body before inserting tube.
4. Moisten end of the tube with water. Push the tube straight into fitting until it bottoms on the fitting's shoulder. Tighten nut by hand. Additional tightening should not be necessary, but 1/4 additional turn may be added if desired. Do not overtighten nut as the threads will strip and the fitting will not function properly. A proper assembly will not show the insertion mark extending beyond the nut. If the insertion mark is visible, then steps 1 thru 4 must be repeated.
5. Whenever a Fast & Tite® fitting is assembled for service or reuse the stainless steel grab ring should be replaced for maximum tubing retention.

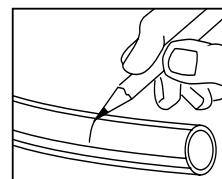
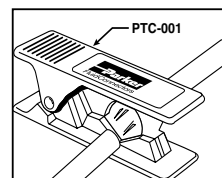

Note: Provide adequate fail-safe mechanisms such as leakage detection sensors, automatic shut-off controls or other industry and code appropriate fail-safe devices in the design of your water-handling appliance to protect against personal injury and property damage. Plastic fittings containing an o-ring have a finite life depending on the environment, media and severity of the application. Frequent inspections and replacement of the fitting when anomalies are found is recommended.

Threaded Fittings

MC
Male Connector
p. B33



ME
Male Elbow
p. B33



FE
Female Elbow
p. B34



FC
Female Connector
p. B34



MR
Male Run Tee
p. B34



MT
Male Branch Tee
p. B34



Tube to Tube

UC
Union
p. B33



EU
Union Elbow
p. B33



TU
Union Tee
p. B34



Bulkhead Union

BU
Bulkhead Union
p. B34



Auxiliary Components

GR
Grab Ring
p. B35



NS
Nut & Spacer
p. B35



TS
Tube Support
p. B35



OR
O-Ring
p. B35



Ball Valves

VUC
Valve Union Connector
p. B36



VMC
Valve Male Connector
p. B36



VFC
Valve Female Connector
p. B36



VFE
Valve Female Elbow
p. B37



VME
Valve Male Elbow
p. B37



VEU
Valve Elbow Union
p. B37



[Click here for CADs, Product Specifications or to Configure Parts Online](#)

MC – Male Connector

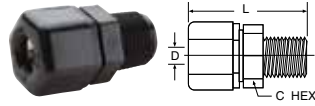

Tube to male pipe

WHITE PPL PART NUMBER	BLACK PPL PART NUMBER	WHITE NYLON PART NUMBER	NOM TUBE O.D.	NPTF THREAD SIZE	C HEX	L OVERALL LENGTH	FLOW DIA. D
W4MC2	P4MC2	N4MC2	1/4	1/8	11/16	1.28	.170
W4MC4	P4MC4	N4MC4	1/4	1/4	11/16	1.51	.170
W4MC6 (+)	P4MC6 (+)	N4MC6 (+)	1/4	3/8	11/16	.148	.170
W5MC2 (+)	P5MC2	N5MC2	5/16	1/8	11/16	1.38	.170
W5MC4 (+)	P5MC4	N5MC4	5/16	1/4	11/16	1.50	.250
W6MC2 (+)	P6MC2	N6MC2	3/8	1/8	13/16	1.50	.170
W6MC4	P6MC4	N6MC4	3/8	1/4	13/16	1.67	.250
W6MC6	P6MC6	N6MC6	3/8	3/8	13/16	1.67	.250
W6MC8 (+)	P6MC8	N6MC8	3/8	1/2	1	1.78	.250
W6MC12	P6MC12	N6MC12	3/8	3/4	1	1.84	.250
W8MC2 (+)	P8MC2	N8MC2	1/2	1/8	1	1.61	.170
W8MC4 (+)	P8MC4	N8MC4	1/2	1/4	1	1.74	.250
W8MC6	P8MC6	N8MC6	1/2	3/8	1	1.74	.375
W8MC8	P8MC8	N8MC8	1/2	1/2	1	1.87	.375
W8MC12 (+)	P8MC12	N8MC12	1/2	3/4	1	1.89	.375
W10MC2 (+)	P10MC2	N10MC2	5/8	1/8	1-1/8	1.75	.170
W10MC4 (+)	P10MC4	N10MC4	5/8	1/4	1-1/8	1.90	.250
W10MC6 (+)	P10MC6	N10MC6	5/8	3/8	1-1/8	1.90	.375
W10MC8 (+)	P10MC8	N10MC8	5/8	1/2	1-1/8	2.01	.500
W10MC12 (+)	P10MC12	N10MC12	5/8	3/4	1-1/8	2.04	.500

ME – Male Elbow

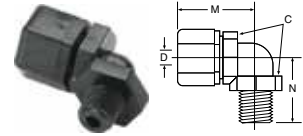

Tube to male pipe

WHITE PPL PART NUMBER	BLACK PPL PART NUMBER	WHITE NYLON PART NUMBER	NOM TUBE O.D.	NPTF THD SIZE	C HEX	M	N	FLOW DIA. D
W4ME2	P4ME2	N4ME2	1/4	1/8	3/4	1.06	0.81	.170
W4ME4	P4ME4	N4ME4	1/4	1/4	3/4	1.06	1.02	.170
W4ME6	P4ME6	N4ME6	1/4	3/8	3/4	1.06	1.02	.170
W5ME2 (+)	P5ME2	N5ME2	5/16	1/8	3/4	1.06	0.81	.193
W5ME4 (+)	P5ME4	N5ME4	5/16	1/4	3/4	1.06	1.02	.193
W5ME6 (+)	P5ME6	N5ME6	5/16	3/8	3/4	1.06	1.02	.193
W6ME4	P6ME4	N6ME4	3/8	1/4	7/8	1.28	1.12	.250
W6ME6	P6ME6	N6ME6	3/8	3/8	7/8	1.28	1.12	.250
W6ME8	P6ME8	N6ME8	3/8	1/2	1	1.28	1.34	.250
W6ME12 (+)	P6ME12	N6ME12	3/8	3/4	1-3/16	1.59	1.40	.250
W8ME4 (+)	P8ME4	N8ME4 (+)	1/2	1/4	1-1/16	1.48	1.22	.250
W8ME6	P8ME6	N8ME6	1/2	3/8	1-1/16	1.56	1.21	.375
W8ME8	P8ME8	N8ME8	1/2	1/2	1-1/16	1.56	1.34	.375
W8ME12 (+)	P8ME12 (+)	N8ME12 (+)	1/2	3/4	1-1/8	1.50	1.40	.375
W10ME8 (+)	P10ME8	N10ME8	5/8	1/2	1-3/16	1.72	1.40	.500

UC – Union Connector

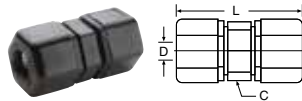

Tube to tube

WHITE PPL PART NUMBER	BLACK PPL PART NUMBER	WHITE NYLON PART NUMBER	NOM. TUBE O.D.	C HEX	L OVERALL LENGTH	FLOW DIA. D
W4UC4	P4UC4	N4UC4	1/4	11/16	1.62	.170
W5UC4 (+)	P5UC4	N5UC4	5/16-1/4	11/16	1.62	.170
W5UC5 (+)	P5UC5	N5UC5	5/16	11/16	1.62	.190
W6UC4	P6UC4	N6UC4	3/8-1/4	13/16	1.80	.170
W6UC5 (+)	P6UC5	N6UC5	3/8-5/16	13/16	1.80	.190
W6UC6	P6UC6	N6UC6	3/8	13/16	1.92	.250
W8UC6	P8UC6	N8UC6	1/2-3/8	1	1.95	.250
W8UC8	P8UC8	N8UC8	1/2	1	2.03	.375
W10UC6 (+)	P10UC6	N10UC6	5/8-3/8	1-1/8	2.19	.250
W10UC8 (+)	P10UC8	N10UC8	5/8-1/2	1-1/8	2.24	.375
W10UC10 (+)	P10UC10	N10UC10	5/8	1-1/8	2.40	.500

EU – Elbow Union

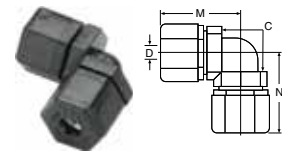

Tube to tube

WHITE PPL PART NUMBER	BLACK PPL PART NUMBER	WHITE NYLON PART NUMBER	NOM. TUBE O.D.	C HEX	M	N	FLOW DIA. D
W4EU4	P4EU4	N4EU4	1/4	3/4	1.06	1.06	.170
W5EU4 (+)	P5EU4	N5EU4	5/16-1/4	3/4	1.06	1.06	.170
W5EU5 (+)	P5EU5	N5EU5	5/16	3/4	1.06	1.06	.193
W6EU4	P6EU4	N6EU4	3/8-1/4	7/8	1.06	1.28	.170
W6EU5 (+)	P6EU5	N6EU5	3/8-5/16	7/8	1.06	1.28	.170
W6EU6	P6EU6	N6EU6	3/8	7/8	1.28	1.28	.250
W8EU6	P8EU6	N8EU6	1/2-3/8	1-1/16	1.37	1.56	.250
W8EU8	P8EU8	N8EU8	1/2	1-1/16	1.56	1.56	.375
W10EU10 (+)	P10EU10	N10EU10	5/8	1-3/16	1.72	1.72	.500

(+) Non-standard

WARNING These products can expose you to chemicals including NICKEL or LEAD, which are known to the state of California to cause cancer.

[Click here for CADs, Product Specifications or to Configure Parts Online](#)

BU – Bulkhead Union

Tube to tube



WHITE PPL PART NUMBER	BLACK PPL PART NO.	WHITE NYLON PART NO.	NOM TUBE O.D.	A REF.	C HEX	L OVERALL LENGTH	P MAX	FLOW DIA. D	BLKHD HOLE DRILL SIZE
W4BU4	P4BU4	N4BU4	1/4	1/4	13/16	2-11/64	3/8	.170	21/32
W5BU5 (+)	P5BU5	N5BU5	5/16	1/4	13/16	2-11/64	3/8	.187	21/32
W6BU6	P6BU6	N6BU6	3/8	9/32	15/16	2-39/64	1/2	.250	25/32
W8BU8	P8BU8	N8BU8	1/2	5/16	1-5/32	2-3/4	1/2	.375	31/32

MR – Male Run Tee

Tube to male pipe

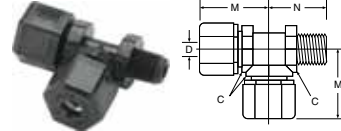

WHITE PPL PART NUMBER	BLACK PPL PART NUMBER	WHITE NYLON PART NUMBER	NOM TUBE O.D.	NPTF THD SIZE	C HEX	M	N	FLOW DIA. D
W4MR2	P4MR2	N4MR2	1/4	1/8	11/16	1.09	0.89	.170
W6MR4	P6MR4	N6MR4	3/8	1/4	13/16	1.30	1.17	.250
W8MR6	P8MR6	N8MR6	1/2	3/8	1	1.46	1.28	.375
W10MR8 (+)	P10MR8	N10MR8	5/8	1/2	1-1/8	1.68	1.50	.500

FE – Female Elbow

Tube to female pipe

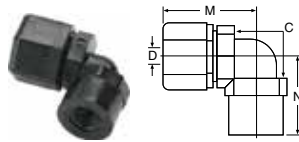

WHITE PPL PART NUMBER	BLACK PPL PART NUMBER	WHITE NYLON PART NUMBER	NOM TUBE O.D.	NPTF THD SIZE	C HEX	M	N	FLOW DIA. D
W4FE2	P4FE2	N4FE2	1/4	1/8	11/16	1.10	0.84	.170
W4FE4	P4FE4	N4FE4	1/4	1/4	11/16	1.10	0.94	.170
W5FE2 (+)	P5FE2	N5FE2	5/16	1/8	11/16	1.10	0.84	.193
W6FE4	P6FE4	N6FE4	3/8	1/4	13/16	1.30	1.06	.250
W6FE6	P6FE6	N6FE6	3/8	3/8	13/16	1.30	1.03	.250
W8FE6 (+)	P8FE6	N8FE6	1/2	3/8	1	1.50	1.16	.375
W8FE8	P8FE8	N8FE8	1/2	1/2	1	1.50	1.27	.375
W10FE8 (+)	P10FE8	N10FE8	5/8	1/2	1-1/8	1.70	1.34	.500

TU – Tee Union

Tube to tube



WHITE PPL PART NUMBER	BLACK PPL PART NUMBER	WHITE NYLON PART NUMBER	NOM. TUBE O.D.	C HEX	M	N	FLOW DIA. D
W4TU4	P4TU4	N4TU4	1/4	11/16	1.09	1.09	.170
W5TU5 (+)	P5TU5	N5TU5	5/16	11/16	1.09	1.09	.187
W6TU6	P6TU6	N6TU6	3/8	13/16	1.30	1.30	.250
W8TU6 (+)	P8TU6	N8TU6	1/2-3/8	1	1.46	1.39	.250
W8TU8	P8TU8	N8TU8	1/2	1	1.46	1.46	.375
W10TU6 (+)	P10TU6	N10TU6	5/8-3/8	1-1/8	1.68	1.46	.250
W10TU10 (+)	P10TU10	N10TU10	5/8	1-3/16	1.68	1.68	.500

FC – Female Connector

Tube to female pipe



WHITE PPL PART NUMBER	BLACK PPL PART NUMBER	WHITE NYLON PART NUMBER	NOM TUBE O.D.	NPTF THREAD SIZE	C HEX	L	FLOW DIA. D
W4FC2	P4FC2	N4FC2	1/4	1/8	11/16	1.31	.170
W4FC4	P4FC4	N4FC4	1/4	1/4	11/16	1.44	.170
W6FC4	P6FC4	N6FC4	3/8	1/4	13/16	1.61	.250
W6FC6	P6FC6	N6FC6	3/8	3/8	13/16	1.64	.250
W6FC8	P6FC8	N6FC8	3/8	1/2	13/16	1.75	.250
W8FC6 (+)	P8FC6	N8FC6	1/2	3/8	1	1.70	.375
W8FC8	P8FC8	N8FC8	1/2	1/2	1	1.85	.375
W10FC8 (+)	P10FC8	N10FC8	5/8	1/2	1-1/8	1.96	.500

MT – Male Branch Tee

Tube to male pipe

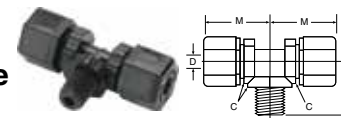

WHITE PPL PART NUMBER	BLACK PPL PART NUMBER	WHITE NYLON PART NUMBER	NOM. TUBE O.D.	NPTF THD SIZE	C HEX	M	N	FLOW DIA. D
W4MT2	P4MT2	N4MT2	1/4	1/8	11/16	1.09	0.89	.170
W4MT4	P4MT4	N4MT4	1/4	1/4	11/16	1.09	1.06	.170
W5MT2 (+)	P5MT2	N5MT2	5/16	1/8	11/16	1.09	0.89	.170
W5MT4 (+)	P5MT4	N5MT4	5/16	1/4	11/16	1.09	1.06	.187
W6MT4	P6MT4	N6MT4	3/8	1/4	13/16	1.30	1.12	.250
W6MT6	P6MT6	N6MT6	3/8	3/8	13/16	1.30	1.10	.250
W8MT6	P8MT6	N8MT6	1/2	3/8	1	1.46	1.22	.375
W8MT8	P8MT8	N8MT8	1/2	1/2	1	1.46	1.43	.375
W10MT8 (+)	P10MT8	N10MT8	5/8	1/2	1-1/8	1.68	1.41	.500

(+) Non-standard

WARNING These products can expose you to chemicals including NICKEL or LEAD, which are known to the state of California to cause cancer.

[Click here for CADs, Product Specifications or to Configure Parts Online](#)

GR – Grab Ring



(Stainless or Plastic)

STAINLESS GRAB RING PART NUMBER	PLASTIC GRAB RING PART NUMBER	FOR NOM. TUBE O. D.
4GR	4GRP	1/4
5GR	5GRP	5/16
6GR	6GRP	3/8
8GR	8GRP	1/2
10GR	10GRP	5/8

NS – Nut and Spacer Sets



WHITE POLYPROPYLENE PART NUMBER	BLACK POLYPROPYLENE PART NUMBER	WHITE NYLON PARTNUMBER	FOR NOM. TUBE O. D.
W4NS	P4NS	N4NS	1/4
W5NS	P5NS	N5NS	5/16
W6NS	P6NS	N6NS	3/8
W8NS	P8NS	N8NS	1/2
W10NS	P10NS	N10NS	5/8

TS – Tube Support



POLYPROPYLENE PART NUMBER	NYLON PART NUMBER	FOR TUBE PART NUMBER
P4TS3	N4TS3	PV43
P5TS3	N5TS3	PV53
P6TS4	N6TS3	PV64
P8TS6	N8TS6	PV86
P10TS8	N10TS8	PV108

OR – O-Ring



FOR NOM. TUBE O. D.	NITRILE O-RING	FLUOROCARBON O-RING	EPDM O-RING
1/4	4OR	4OR-V	4OR-EPDM
5/16	5OR	5OR-V	5OR-EPDM
3/8	6OR	6OR-V	6OR-EPDM
1/2	8OR	8OR-V	8OR-EPDM
5/8	10OR	10OR-V	10OR-EPDM

WARNING These products can expose you to chemicals including NICKEL or LEAD, which are known to the state of California to cause cancer.

Fast and Tite Ball Valves

This range of ball valves uses compression technology to create a sure and tight connection. Use Parker's Fast and Tite fittings for low pressure applications such as water filtration, beverage dispensing, or on vacuum lines. Manufactured from black polypropylene material, these valves meet FDA and NSF-51 requirements for food contact.

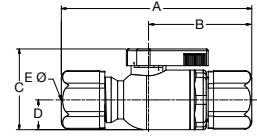

Features/Benefits:

- 302 Stainless Steel Grab Ring
- Nitrile O-ring
- FDA Compliant
- NSF/ANSI-51 Compliant

Specifications:

- Temperature Range: +35° F to +200° F (+1° C to +93° C)
- O-ring Seal Material: Nitrile
- NSF/ANSI 51
- Pressure Rated to 150PSI

Assembly Instructions:

1. Cut the tube squarely and remove any burrs.
2. Mark from end of tube the length of insertion. If using a tube support, insert fully into tube before marking. (See insertion length table left)
3. Loosen nut on fitting until three threads are visible. Fittings for glass tubes must be disassembled and the grab ring removed. If the fitting has been disassembled the components are to be placed in the following order: fitting body, o-ring, spacer, grab ring and nut. Assemble the nut until three threads are showing on the body before inserting tube.
4. Moisten end of the tube with water. Push the tube straight into fitting until it bottoms on the fitting's shoulder. Tighten nut by hand. Additional tightening should not be necessary, but 1/4 additional turn may be added if desired. Do not overtighten nut as the threads will strip and the fitting will not function properly. A proper assembly will not show the insertion mark extending beyond the nut. If the insertion mark is visible, then steps 1 thru 4 must be repeated.
5. Whenever a Fast & Tite® fitting is assembled for service or reuse the stainless steel grab ring should be replaced for maximum tubing retention.

Note: Provide adequate fail-safe mechanisms such as leakage detection sensors, automatic shut-off controls or other industry and code appropriate fail-safe devices in the design of your water-handling appliance to protect against personal injury and property damage. Plastic fittings containing an o-ring have a finite life depending on the environment, media and severity of the application. Frequent inspections and replacement of the fitting when anomalies are found is recommended.

VUC - Valve Union Connector

PART NO.	1 TUBE SIZE	2 TUBE SIZE	A	B	C	D	ØE THRU HOLE MIN.
FTPPB4VUC4	1/4	1/4	2.94	1.61	1.4	.5	.19
FTPPB4VUC6	1/4	3/8	3.07	1.61	1.4	.5	.19
FTPPB6VUC6	3/8	3/8	3.19	1.73	1.4	.5	.25
FTPPB8VUC8	1/2	1/2	3.27	1.80	1.4	.5	.38

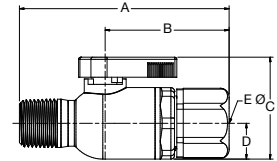

VMC - Valve Male Connector

PART NO.	1 TUBE SIZE	NPTF THD SIZE	A	B	C	D	ØE THRU HOLE MIN.
FTPPB4VMC4	1/4	1/4	2.81	1.61	1.4	.5	.19
FTPPB4VMC6	1/4	3/8	2.81	1.61	1.4	.5	.19
FTPPB6VMC4	3/8	1/4	2.93	1.73	1.4	.5	.19
FTPPB6VMC6	3/8	3/8	2.93	1.73	1.4	.5	.25
FTPPB8VMC6	1/2	3/8	3.00	1.79	1.4	.5	.25

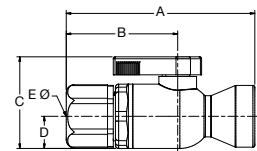

VFC - Valve Female Connector

PART NO.	1 TUBE SIZE	NPTF THD SIZE	A	B	C	D	ØE THRU HOLE MIN.
FTPPB4VFC4	1/4	1/4	2.78	1.61	1.4	.5	.19
FTPPB6VFC6	3/8	3/8	2.93	1.73	1.4	.5	.25
FTPPB8VFC6	1/2	3/8	3.00	1.8	1.4	.5	.25

WARNING These products can expose you to chemicals including NICKEL or LEAD, which are known to the state of California to cause cancer.

[Click here for CADs, Product Specifications or to Configure Parts Online](#)

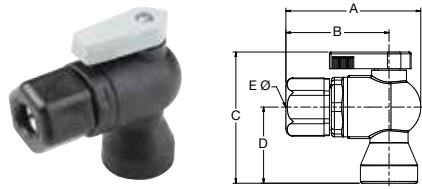

VFE - Valve Female Elbow

PART NO.	1 TUBE SIZE	NPTF THD SIZE	A	B	C	D	ØE THRU HOLE MIN.
FTPPB4VFE4	1/4	1/4	2.14	1.61	2.18	1.25	.19
FTPPB6VFE4	3/8	1/4	2.26	1.73	2.18	1.25	.19
FTPPB6VFE6	3/8	3/8	2.26	1.73	2.21	1.28	.25
FTPPB8VFE6	1/2	3/8	2.34	1.8	2.21	1.28	.25

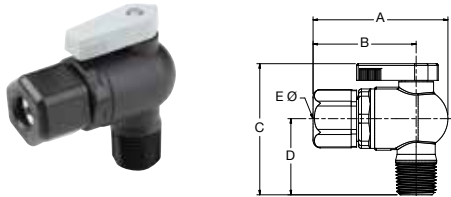

VME - Valve Male Elbow

PART NO.	1 TUBE SIZE	NPTF THD SIZE	A	B	C	D	ØE THRU HOLE MIN.
FTPPB4VME4	1/4	1/4	2.14	1.61	2.21	1.28	.19
FTPPB6VME4	3/8	1/4	2.26	1.73	2.21	1.28	.19
FTPPB6VME6	3/8	3/8	2.26	1.73	2.21	1.28	.25
FTPPB8VME8	1/2	1/2	2.34	1.8	2.4	1.47	.38

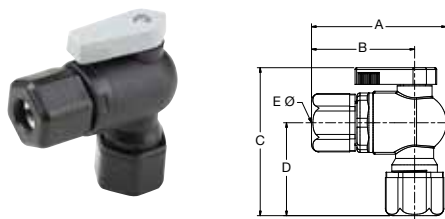

VEU - Valve Elbow Union

PART NO.	1 TUBE SIZE	2 TUBE SIZE	A	B	C	D	ØE THRU HOLE MIN.
FTPPB4VEU4	1/4	1/4	2.14	1.61	2.35	1.42	.19
FTPPB6VEU4	3/8	1/4	2.26	1.73	2.37	1.44	.19
FTPPB6VEU6	3/8	3/8	2.26	1.73	2.49	1.56	.25
FTPPB8VEU8	1/2	1/2	2.34	1.8	2.47	1.54	.38

WARNING These products can expose you to chemicals including NICKEL or LEAD, which are known to the state of California to cause cancer.

Par-Barb® Fittings



Parker's Par-Barb Fittings are injection molded from high strength chemically inert, thermoplastic materials. The multiple barb design generates the maximum gripping and sealing power when combined with a hose clamp.

Product Features:

- Available in black polypropylene and white nylon
- FDA compliant material
- NSF/ANSI 51
- Uniprene washer
- Up to 1 1/2" sizes

Markets:

- Water
- Beverage Dispensing
- Bottling
- Semi-Conductor

Applications:

- Water
- Beverages
- Cooling Systems



Specifications:

Pressure Range Up to 125 psi PSI (8.6 bar)

Temperature Range

Nylon: -40° to +200° F (-40° to +93.3° C)

Polypropylene: 0° to +212° F (-17.7 ° to +100° C)

Compatible Tubing:

- Vinyl
- Polyurethane
- Rubber hose

■ Tube to Male NPTF

325HB

Male Connector
p. B41



372HB

Male Branch Tee
p. B42



329HB

Male Elbow
p. B42



■ Tube to Female NPTF

326HB

Female Connector
p. B41



370HB

Female Elbow
p. B42



■ Tube to Tube

322HB

Union
p. B40



364HB

Union Tee
p. B40



365HB

Union Elbow
p. B40



362HB

Union Y
p. B42



■ Pipe Fittings

318P

Hex Plug
p. B40



309P

Bushing
p. B40



316P

Nipple
p. B41



■ Garden Hose Fitting

316GH

Garden Hose Adapter
p. B43



325GH

Garden Hose Connector
p. B43



■ Auxiliary Component

328HB

Hose Barb Stem
p. B43



31HB

Hose Barb Swivel Nut
p. B43



325GHSV

Swivel Hose Barb Stem
p. B43



31GH

Garden Hose Nut
p. B43



313GH

Garden Hose Cap
p. B43



30GH

Garden Hose Washer
p. B43



■ Ball Valves

VFC

Female Connector
p. B43



VFE

Female Elbow
p. B44



VMC

Male Connector
p. B44



VME

Male Elbow
p. B44



VEU

Parbarb Elbow Ball Valve
p. B44



VUC

Union Connector
p. B44



VUCPB

Barb x Tuber
p. B44



BVC

Ball Valve Clip
p. B44



[Click here for CADs, Product Specifications or to Configure Parts Online](#)



Union Connector 322HB

WHITE NYLON PART NO.	BLACK POLYPROPYLENE PART NO.	TUBE OR HOSE I.D. 1	TUBE OR HOSE I.D. 2	O.D. 1	O.D. 2	L	FLOW DIA. D
322HB-2N*	322HB-2PP*	1/8	1/8	.18	.18	.66	.09
322HB-3N	322HB-3PP	3/16	3/16	.25	.25	1.61	.12
322HB-4-2N	322HB-4-2PP	1/4	1/8	.31	.21	1.61	.08
322HB-4-3N	322HB-4-3PP	1/4	3/16	.31	.25	1.61	.13
322HB-4N	322HB-4PP	1/4	1/4	.31	.31	1.61	.16
322HB-5N	322HB-5PP	5/16	5/16	.37	.37	1.61	.22
322HB-6-4N	322HB-6-4PP	3/8	1/4	.43	.31	1.61	.15
322HB-6-5N	322HB-6-5PP	3/8	5/16	.43	.37	1.62	.22
322HB-6N	322HB-6PP	3/8	3/8	.43	.43	1.61	.25
322HB-8-4N	322HB-8-4PP	1/2	1/4	.55	.31	1.73	.15
322HB-8-6N	322HB-8-6PP	1/2	3/8	.55	.43	1.73	.25
322HB-8N	322HB-8PP	1/2	1/2	.56	.56	1.74	.38
322HB-10-6N	322HB-10-6PP	5/8	3/8	.66	.43	1.73	.25
322HB-10-8N	322HB-10-8PP	5/8	1/2	.66	.55	1.73	.37
322HB-10N	322HB-10PP	5/8	5/8	.67	.67	1.73	.47
322HB-12-8N	322HB-12-8PP	3/4	1/2	.81	.55	2.99	.38
322HB-12N	322HB-12PP	3/4	3/4	.80	.80	2.97	.58
322HB-16N		1	1	1.08	1.08	3.12	.82
322HB-20N		1-1/4	1-1/4	1.26	1.26	3.58	1.00
322HB-24N		1-1/2	1-1/2	1.51	1.51	3.58	1.25

*Note: 1/8" tube connections contain one barb.

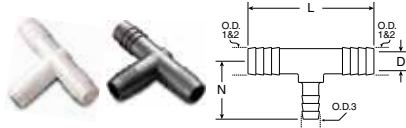

Union Tee 364HB

WHITE NYLON PART NO.	BLACK POLYPROPYLENE PART NO.	TUBE OR HOSE I.D. 1-2	TUBE OR HOSE I.D. 3	O.D. 1-2	O.D. 3	L	N	FLOW DIA. D
364HBM-2N*		1/8	1/8	.15	.15	1.19	.60	.08
364HB-3N	364HB-3PP	3/16	3/16	.25	.25	1.49	.75	.12
364HB-4N	364HB-4PP	1/4	1/4	.32	.32	1.92	.96	.16
364HB-4-6N		1/4	3/8	.32	.44	1.92	1.18	.16
364HB-5N	364HB-5PP	5/16	5/16	.36	.36	2.22	1.17	.22
364HB-6-3N	364HB-6-3PP	3/8	3/16	.43	.24	2.23	1.04	.09
364HB-6-4N	364HB-6-4PP	3/8	1/4	.44	.32	1.92	1.18	.16
364HB-6N	364HB-6PP	3/8	3/8	.43	.43	2.22	1.18	.25
364HB-6-8N	364HB-6-8PP	3/8	1/2	.43	.56	2.22	1.27	.25
364HB-8-6N	364HB-8-6PP	1/2	3/8	.55	.43	2.52	1.27	.25
364HB-8N	364HB-8PP	1/2	1/2	.56	.56	2.52	1.27	.37
364HB-10N	364HB-10PP	5/8	5/8	.66	.66	2.74	1.37	.46
364HB-12N		3/4	3/4	.81	.81	2.98	1.50	.58
364HB-16N		1	1	1.06	1.06	3.10	1.55	.81
364HB-20N		1-1/4	1-1/4	1.25	1.25	5.29	2.64	1.00
364HB-24N		1-1/2	1-1/2	1.51	1.51	5.48	2.74	1.25

*Note: 1/8" tube connections contain one barb.



Union Elbow 365HB

WHITE NYLON PART NO.	BLACK POLYPROPYLENE PART NO.	TUBE OR HOSE I.D. 1	TUBE OR HOSE I.D. 2	O.D. 1	O.D. 2	M	N	FLOW DIA. D
365HB-3N	365HB-3PP	3/16	3/16	.25	.25	.75	.75	.12
365HB-4N	365HB-4PP	1/4	1/4	.31	.31	1.13	1.13	.15
365HB-5N	365HB-5PP	5/16	5/16	.38	.37	1.19	1.19	.22
365HB-6N	365HB-6PP	3/8	3/8	.43	.43	1.26	1.26	.25
365HB-8-4N	365HB-8-4PP	1/2	1/4	.55	.31	1.26	1.24	.16
365HB-8-6N	365HB-8-6PP	1/2	3/8	.55	.43	1.26	1.27	.25
365HB-8N	365HB-8PP	1/2	1/2	.55	.55	1.26	1.26	.37
365HB-10N	365HB-10PP	5/8	5/8	.66	.66	1.37	1.37	.46
365HB-12N	365HB-12PP	3/4	3/4	.80	.80	1.48	1.48	.57
365HB-16N		1	1	1.07	1.07	1.50	1.50	.81
365HB-20N		1-1/4	1-1/4	1.25	1.25	2.63	2.63	1.00
365HB-24N		1-1/2	1-1/2	1.50	1.50	2.74	2.74	1.25



Hex Plug 318P

WHITE NYLON PART NO.	BLACK POLYPROPYLENE PART NO.	NPT PIPE THREAD	C HEX	L
318P-2N	318P-2PP	1/8	7/16	.62
318P-4N	318P-4PP	1/4	9/16	.75
318P-6N	318P-6PP	3/8	11/16	.74
318P-8N	318P-8PP	1/2	7/8	.87
318P-12N	318P-12PP	3/4	1-1/8	.86
318P-16N	318P-16PP	1	1-3/8	1.05
318P-20N	318P-20PP	1-1/4	1-1/2	1.44
318P-24N	318P-24PP	1-1/2	1-3/4	1.61



Reducer Bushing 309P

WHITE NYLON PART NO.	BLACK POLYPROPYLENE PART NO.	EXTERNAL NPT PIPE THREAD	INTERNAL NPT PIPE THREAD	C HEX	L
309P-4-2N	309P-4-2PP	1/4	1/8	9/16	.75
309P-6-2N	309P-6-2PP	3/8	1/8	11/16	.74
309P-6-4N	309P-6-4PP	3/8	1/4	11/16	.75
309P-8-2N	309P-8-2PP	1/2	1/8	7/8	.88
309P-8-4N	309P-8-4PP	1/2	1/4	7/8	.87
309P-8-6N	309P-8-6PP	1/2	3/8	7/8	.87
309P-12-2N	309P-12-2PP	3/4	1/8	1-1/8	.86
309P-12-4N	309P-12-4PP	3/4	1/4	1-1/8	.75
309P-12-6N	309P-12-6PP	3/4	3/8	1-1/8	.85
309P-12-8N	309P-12-8PP	3/4	1/2	1-1/8	.87

[Click here for CADs, Product Specifications or to Configure Parts Online](#)



Hex Nipple 316P

WHITE NYLON PART NO.	BLACK POLYPROPYLENE PART NO.	NPT PIPE THREAD SIDE 1	NPT PIPE THREAD SIDE 2	C HEX	L	FLOW DIA. D
316P-2N	316P-2PP	1/8	1/8	7/16	.99	.22
316P-4-2N	316P-4-2PP	1/4	1/8	9/16	1.13	.22
316P-4N	316P-4PP	1/4	1/4	9/16	1.24	.31
316P-6-2N	316P-6-2PP	3/8	1/8	11/16	1.11	.22
316P-6-4N	316P-6-4PP	3/8	1/4	11/16	1.25	.31
316P-6N	316P-6PP	3/8	3/8	11/16	1.23	.43
316P-8-2N	316P-8-2PP	1/2	1/8	7/8	1.23	.22
316P-8-4N	316P-8-4PP	1/2	1/4	7/8	1.36	.31
316P-8-6N	316P-8-6PP	1/2	3/8	7/8	1.35	.43
316P-8N	316P-8PP	1/2	1/2	7/8	1.45	.59
316P-12-6N	316P-12-6PP	3/4	3/8	1-1/8	1.36	.43
316P-12-8N	316P-12-8PP	3/4	1/2	1-1/8	1.47	.59
316P-12N	316P-12PP	3/4	3/4	1-1/8	1.48	.74
316P-16N	316P-16PP	1	1	1-3/8	1.85	.98

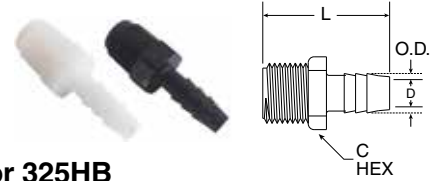

Male Connector 325HB

WHITE NYLON PART NO.	BLACK POLYPROPYLENE PART NO.	TUBE OR HOSE I.D.	NPT PIPE THD.	O.D.	C HEX	L	FLOW DIA. D
325HB-3-2N	325HB-3-2PP	3/16	1/8	.25	7/16	1.49	.12
325HB-3-4N	325HB-3-4PP	3/16	1/4	.25	9/16	1.61	.13
325HB-4-2N	325HB-4-2PP	1/4	1/8	.31	7/16	1.50	.15
325HB-4-4N	325HB-4-4PP	1/4	1/4	.31	9/16	1.60	.16
325HB-4-6N		1/4	3/8	.31	11/16	1.62	.16
325HB-4-8N	325HB-4-8PP	1/4	1/2	.31	7/8	1.73	.15
325HB-4-12N		1/4	3/4	.31	1-1/8	1.74	.16
325HB-5-2N		5/16	1/8	.37	7/16	1.50	.22
325HB-5-4N		5/16	1/4	.37	9/16	1.62	.22
325HB-5-6N	325HB-5-6PP	5/16	3/8	.37	11/16	1.60	.21
325HB-6-2N	325HB-6-2PP	3/8	1/8	.43	7/16	1.49	.25
325HB-6-4N	325HB-6-4PP	3/8	1/4	.43	9/16	1.62	.25
325HB-6-6N	325HB-6-6PP	3/8	3/8	.43	11/16	1.61	.25
325HB-6-8N	325HB-6-8PP	3/8	1/2	.43	7/8	1.73	.25
325HB-6-12N	325HB-6-12PP	3/8	3/4	.43	1-1/8	1.72	.25
325HB-8-4N	325HB-8-4PP	1/2	1/4	.55	9/16	1.61	.35
325HB-8-6N	325HB-8-6PP	1/2	3/8	.55	11/16	1.60	.37
325HB-8-8N	325HB-8-8PP	1/2	1/2	.55	7/8	1.73	.37
325HB-8-12N	325HB-8-12PP	1/2	3/4	.55	1-1/8	1.72	.37
325HB-10-6N	325HB-10-6PP	5/8	3/8	.66	11/16	1.61	.46
325HB-10-8N	325HB-10-8PP	5/8	1/2	.66	7/8	1.73	.46
325HB-10-12N	325HB-10-12PP	5/8	3/4	.67	1-1/8	1.82	.46
325HB-12-8N	325HB-12-8PP	3/4	1/2	.80	7/8	1.86	.62
325HB-12-12N	325HB-12-12PP	3/4	3/4	.80	1-1/8	1.85	.62
325HB-12-16N		3/4	1	.82	1-3/8	2.35	.59
325HB-12-20N		3/4	1-1/4	.86	1-1/2	3.47	.59
325HB-12-24N		3/4	1-1/2	.86	1-3/4	3.66	.59
325HB-16-8N		1	1/2	1.08	1-1/8	2.49	.77
325HB-16-12N		1	3/4	1.07	1-1/8	2.30	.81
325HB-16-16N		1	1	1.07	1-3/8	2.35	.81
325HB-16-20N		1	1-1/4	1.11	1-1/2	3.45	.78
325HB-16-24N		1	1-1/2	1.11	1-3/4	3.63	.78
325HB-20-20N		1-1/4	1-1/4	1.36	1-1/2	3.47	1.04
325HB-20-24N		1-1/4	1-1/2	1.36	1-3/4	3.64	1.04
325HB-24-20N		1-1/2	1-1/4	1.60	1-1/2	3.45	1.28
325HB-24-24N		1-1/2	1-1/2	1.61	1-3/4	3.63	1.28

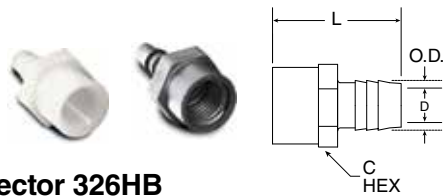

Female Connector 326HB

WHITE NYLON PART NO.	BLACK POLYPROPYLENE PART NO.	TUBE OR HOSE I.D.	NPT PIPE THREAD	O.D.	C HEX	L	FLOW DIA. D
326HB-3-2N	326HB-3-2PP	3/16	1/8	.25	5/8	1.29	.12
326HB-3-4N	326HB-3-4PP	3/16	1/4	.25	3/4	1.31	.13
326HB-4-2N	326HB-4-2PP	1/4	1/8	.31	5/8	1.51	.16
326HB-4-4N	326HB-4-4PP	1/4	1/4	.31	3/4	1.52	.15
326HB-4-6N	326HB-4-6PP	1/4	3/8	.31	1	1.73	.15
326HB-4-8N	326HB-4-8PP	1/4	1/2	.31	1-1/8	1.74	.15
326HB-6-2N	326HB-6-2PP	3/8	1/8	.44	5/8	1.51	.25
326HB-6-4N	326HB-6-4PP	3/8	1/4	.43	3/4	1.52	.25
326HB-6-6N	326HB-6-6PP	3/8	3/8	.43	1	1.73	.25
326HB-6-8N	326HB-6-8PP	3/8	1/2	.43	1-1/8	1.74	.25
326HB-8-4N	326HB-8-4PP	1/2	1/4	.55	3/4	1.52	.37
326HB-8-6N	326HB-8-6PP	1/2	3/8	.55	1	1.74	.37
326HB-8-8N	326HB-8-8PP	1/2	1/2	.56	1-1/8	1.74	.37
326HB-10-6N	326HB-10-6PP	5/8	3/8	.66	1	1.61	.46
326HB-10-8N	326HB-10-8PP	5/8	1/2	.66	1-1/8	1.73	.46
326HB-12-8N	326HB-12-8PP	3/4	1/2	.80	1-1/8	1.86	.62
326HB-12-12N	326HB-12-12PP	3/4	3/4	.80	1-1/8	1.85	.62

[Click here for CADs, Product Specifications or to Configure Parts Online](#)



Male Branch Tee 372HB

WHITE NYLON PART NO.	BLACK POLYPROPYLENE PART NO.	TUBE OR HOSE I.D.	NPT PIPE THD.	O.D.	C HEX	L	N	FLOW DIA. D
372HB-3-2N		3/16	1/8	.25	7/16	1.94	1.06	.13
372HB-3-4N		3/16	1/4	.24	9/16	1.93	1.17	.13
372HB-4-2N	372HB-4-2PP	1/4	1/8	.32	7/16	1.92	1.06	.16
372HB-4-4N	372HB-4-4PP	1/4	1/4	.32	9/16	1.92	1.16	.16
372HB-4-6N	372HB-4-6PP	1/4	3/8	.32	11/16	1.92	1.18	.16
372HB-6-4N	372HB-6-4PP	3/8	1/4	.43	9/16	2.22	1.18	.25
372HB-6-6N	372HB-6-6PP	3/8	3/8	.43	11/16	2.22	1.17	.25
372HB-6-8N	372HB-6-8PP	3/8	1/2	.43	7/8	2.22	1.29	.25
372HB-8-4N	372HB-8-4PP	1/2	1/4	.55	9/16	2.52	1.17	.37
372HB-8-6N	372HB-8-6PP	1/2	3/8	.56	11/16	2.52	1.17	.37
372HB-8-8N	372HB-8-8PP	1/2	1/2	.55	7/8	2.52	1.30	.37
372HB-12-12N	372HB-12-12PP	3/4	3/4	.81	1-1/8	2.97	1.92	.58
372HB-16-8N		1	1/2	1.07	7/8	3.10	1.74	.81
372HB-16-12N		1	3/4	1.07	1-1/8	3.10	1.92	.81
372HB-16-16N		1	1	1.07	1-3/8	3.11	1.98	.81



Male Elbow 329HB

WHITE NYLON PART NO.	BLACK POLYPROPYLENE PART NO.	TUBE OR HOSE I.D.	NPT PIPE THD.	O.D.	C HEX	M	N	FLOW DIA. D
329HB-3-2N	329HB-3-2PP	3/16	1/8	.25	7/16	.76	1.06	.12
329HB-3-4N		3/16	1/4	.25	9/16	.76	1.17	.13
329HB-4-2N	329HB-4-2PP	1/4	1/8	.31	7/16	1.18	1.04	.16
329HB-4-4N	329HB-4-4PP	1/4	1/4	.31	9/16	1.18	1.16	.22
329HB-4-6N	329HB-4-6PP	1/4	3/8	.31	11/16	1.18	1.17	.15
329HB-4-8N	329HB-4-8PP	1/4	1/2	.32	7/8	1.18	1.30	.15
329HB-5-2N		5/16	1/8	.37	7/16	1.18	1.06	.22
329HB-6-2N	329HB-6-2PP	3/8	1/8	.43	7/16	1.18	1.05	.25
329HB-6-4N	329HB-6-4PP	3/8	1/4	.43	9/16	1.18	1.16	.25
329HB-6-6N	329HB-6-6PP	3/8	3/8	.43	11/16	1.17	1.17	.25
329HB-6-8N	329HB-6-8PP	3/8	1/2	.43	7/8	1.18	1.28	.25
329HB-8-4N	329HB-8-4PP	1/2	1/4	.55	9/16	1.27	1.16	.37
329HB-8-6N	329HB-8-6PP	1/2	3/8	.56	11/16	1.26	1.16	.37
329HB-8-8N	329HB-8-8PP	1/2	1/2	.55	7/8	1.25	1.29	.37
329HB-8-12N	329HB-8-12PP	1/2	3/4	.55	1-1/8	1.30	1.89	.37
329HB-10-6N		5/8	3/8	.67	11/16	1.27	1.18	.47
329HB-10-8N	329HB-10-8PP	5/8	1/2	.68	7/8	1.30	1.73	.48
329HB-10-12N	329HB-10-12PP	5/8	3/4	.69	1-1/8	1.32	1.92	.49
329HB-12-8N	329HB-12-8PP	3/4	1/2	.81	7/8	1.51	1.74	.58
329HB-12-12N	329HB-12-12PP	3/4	3/4	.81	1-1/8	1.50	1.91	.58
329HB-12-16N		3/4	1	.82	1-3/8	1.49	1.98	.58
329HB-12-20N		3/4	1-1/4	.86	1-1/2	1.52	2.39	.59
329HB-12-24N		3/4	1-1/2	.85	1-1/2	2.26	3.09	.59
329HB-16-8N		1	1/2	1.12	7/8	1.58	1.78	.86
329HB-16-12N		1	3/4	1.11	1-1/8	1.58	1.93	.86
329HB-16-16N		1	1	1.08	1-3/8	1.55	1.98	.81
329HB-16-20N		1	1-1/4	1.12	1-1/2	2.28	2.93	.84
329HB-16-24N		1	1-1/2	1.12	1-1/2	2.27	3.11	.84
329HB-20-20N		1-1/4	1-1/4	1.25	1-1/2	2.63	2.94	1.00
329HB-20-24N		1-1/4	1-1/2	1.36	1-1/2	2.63	3.11	1.08
329HB-24-20N		1-1/2	1-1/4	1.60	1-1/2	2.77	2.93	1.30
329HB-24-24N		1-1/2	1-1/2	1.60	1-1/2	2.77	3.10	1.30



Female Elbow 370HB

WHITE NYLON PART NO.	BLACK POLYPROPYLENE PART NO.	TUBE OR HOSE I.D.	NPT PIPE THD.	O.D.	C HEX	M	N	FLOW DIA. D
370HB-4-2N	370HB-4-2PP	1/4	1/8	.31	5/8	1.19	1.07	.16
370HB-4-4N	370HB-4-4PP	1/4	1/4	.31	3/4	1.18	1.08	.16
370HB-4-6N	370HB-4-6PP	1/4	3/8	.31	1	1.16	1.30	.16
370HB-4-8N	370HB-4-8PP	1/4	1/2	.31	1-1/8	1.18	1.30	.15
370HB-6-2N	370HB-6-2PP	3/8	1/8	.43	5/8	1.18	1.06	.25
370HB-6-4N	370HB-6-4PP	3/8	1/4	.44	3/4	1.18	1.06	.25
370HB-6-6N	370HB-6-6PP	3/8	3/8	.43	1	1.18	1.29	.25
370HB-6-8N	370HB-6-8PP	3/8	1/2	.43	1-1/8	1.18	1.29	.25
370HB-8-4N	370HB-8-4PP	1/2	1/4	.55	3/4	1.25	1.22	.37
370HB-8-6N	370HB-8-6PP	1/2	3/8	.55	1	1.25	1.44	.37
370HB-8-8N	370HB-8-8PP	1/2	1/2	.55	1-1/8	1.25	1.45	.37
370HB-8-12N	370HB-8-12PP	1/2	3/4	.55	1-3/8	1.26	1.72	.37
370HB-12-12N	370HB-12-12PP	3/4	3/4	.80	1-3/8	1.38	1.84	.59

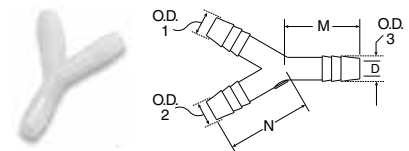

Union Y 362HB

WHITE NYLON PART NO.	TUBE OR HOSE I.D. 1 & 2	TUBE OR HOSE I.D. 3	O.D. 1 & 2	O.D. 3	M	N	FLOW DIA. D
362HB-4N	1/4	1/4	.31	.31	1.13	1.13	.16
362HB-6N	3/8	3/8	.43	.43	1.25	1.40	.25
362HB-8N	1/2	1/2	.55	.55	1.25	1.50	.38

[Click here for CADs, Product Specifications or to Configure Parts Online](#)



Ball Nose Hose Barb Stem 328HB

WHITE NYLON PART NO.	BLACK POLYPROPYLENE PART NO.	TUBE OR HOSE I.D.	SWIVEL NUT NPT PIPE THREAD	O.D.	L	FLOW DIA. D
328HB-4BN	328HB-4BPP	1/4	1/4 *	.30	1.19	.19
328HB-4-8BN	328HB-4-8BPP	1/4	1/2 *	.30	1.29	.15
328HB-6BN	328HB-6BPP	3/8	3/8 *	.56	1.41	.25
328HB-8BN	328HB-8BPP	1/2	1/2 *	.67	1.30	.37

*Use with hose barb swivel nut (31HB-XX) for desired NPT thread.

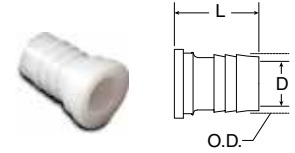

Garden Hose Swivel Hose Barb Stem 325GHSV

WHITE NYLON PART NO.	TUBE OR HOSE I.D.	GARDEN HOSE THREAD	O.D.	L	FLOW DIA. D
325GHSV-4-12BN*	1/4	3/4	.31	1.16	.16
325GHSV-6-12BN*	3/8	3/4	.44	1.17	.25
325GHSV-8-12BN*	1/2	3/4	.56	1.17	.38
325GHSV-10-12BN*	5/8	3/4	.64	1.18	.47
325GHSV-12-12BN*	3/4	3/4	.81	1.18	.62

*Use with Garden Hose washer (30GH-12) and Garden Hose Nut (31GH-12N)



Hose Barb Swivel Nut 31HB

WHITE NYLON PART NO.	BLACK POLYPROPYLENE PART NO.	NPT PIPE THREAD	C HEX	L
31HB-4N	31HB-4PP	1/4	3/4	.62
31HB-6N	31HB-6PP	3/8	7/8	.63
31HB-8N	31HB-8PP	1/2	1- 1/16	.75



Garden Hose Nut 31GH

WHITE NYLON PART NO.	GARDEN HOSE THREAD	L	DIA. N
31GH-12N	3/4	.74	1.38

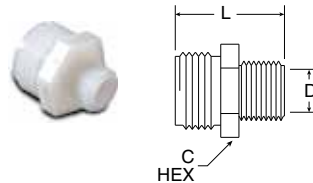

Male Garden Hose - Male Pipe Adapter 316GH

WHITE NYLON PART NO.	GARDEN HOSE THREAD	NPT PIPE THREAD	C HEX	L	FLOW DIA. D
316GH-12-6N	3/4	3/8	1- 1/8	1.33	.44
316GH-12-8N	3/4	1/2	1- 1/8	1.44	.59
316GH-12-12N	3/4	3/4	1- 1/8	1.48	.75

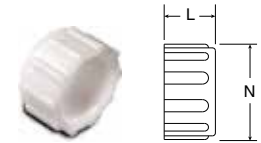

Garden Hose Cap 313GH

WHITE NYLON PART NO.	GARDEN HOSE THREAD	L	DIA. N
313GH-12N**	3/4	.74	1.38

**Use with Garden Hose Washer (30GH-12)

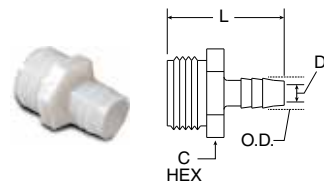

Male Garden Hose - Hose Barb 325GH

WHITE NYLON PART NO.	TUBE OR HOSE I.D.	GARDEN HOSE THREAD	O.D.	C HEX	L	FLOW DIA. D
325GH-4-12N	1/4	3/4	.31	1- 1/8	1.70	.16
325GH-6-12N	3/8	3/4	.44	1- 1/8	1.69	.25
325GH-8-12N	1/2	3/4	.55	1- 1/8	1.68	.38
325GH-10-12N	5/8	3/4	.64	1- 1/8	1.70	.47
325GH-12-12N	3/4	3/4	.81	1- 1/8	1.70	.62



Garden Hose Washer 30GH

WHITE TPE PART NO.	GARDEN HOSE THREAD	L
30GH-12	3/4	.13

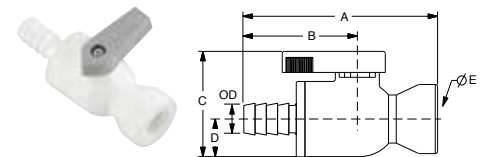

VFC - Valve Barbed Female Connector

PART NO.	HOSE I.D.	NPTF THD.	O.D.	A	B	C	D	ØE THRU HOLE MIN.
PBPP4VFC4	1/4	1/4	.31	2.76	1.60	1.41	.50	.15
PBPP6VFC6	3/8	3/8	.43	2.79	1.60	1.41	.50	.19

[Click here for CADs, Product Specifications or to Configure Parts Online](#)

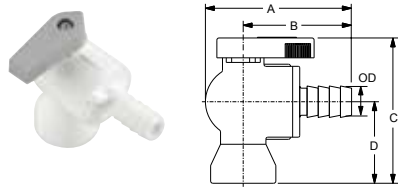

VFE - Valve Barbed Female Elbow

PART NO.	HOSE I.D.	NPTF THD.	O.D.	A	B	C	D	ØE THRU HOLE MIN.
PBPP4VFE4	1/4	1/4	.31	2.13	1.60	2.05	1.15	.15
PBPP6VFE4	3/8	1/4	.43	2.13	1.60	2.05	1.15	.15
PBPP6VFE6	3/8	3/8	.43	2.13	1.60	2.18	1.28	.19

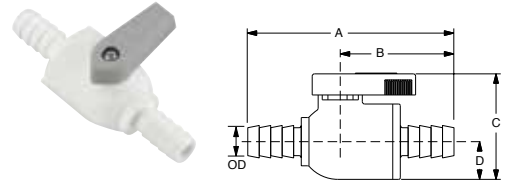

VUC - Valve Barbed Union Connector

PART NO.	HOSE I.D.	O.D.	A	B	C	D	ØE THRU HOLE MIN.
PBPP4VUC4	1/4	.31	2.91	1.60	1.42	.50	.15
PBPP6VUC6	3/8	.43	2.91	1.60	1.42	.50	.19
PBPP8VUC8	1/2	.55	2.91	1.60	1.42	.50	.25

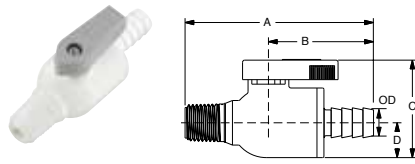

VMC - Valve Barbed Male Connector

PART NO.	HOSE I.D.	NPTF THD.	O.D.	A	B	C	D	ØE THRU HOLE MIN.
PBPP4VMC4	1/4	1/4	.31	2.79	1.60	1.42	.50	.15
PBPP6VMC6	3/8	3/8	.43	2.79	1.60	1.42	.50	.19

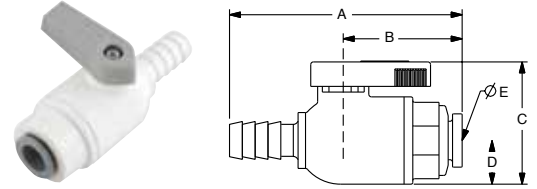

VUCPB - Valve Union Connector Barbed x Tube

PART NO.	HOSE ID	TUBE OD	OD	A	B	C	D	ØE THRU HOLE MIN.
LFPP4VUCPB4	1/4	1/4	.31	2.40	1.08	1.42	.50	.15
LFPP6VUCPB6	3/8	3/8	.43	2.63	1.32	1.42	.50	.19

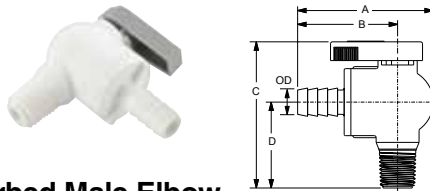

VME - Valve Barbed Male Elbow

PART NO.	HOSE I.D.	NPTF THD.	O.D.	A	B	C	D	ØE THRU HOLE MIN.
PBPP4VME4	1/4	1/4	.31	2.13	1.60	2.18	1.28	.15
PBPP6VME6	3/8	3/8	.43	2.13	1.60	2.18	1.28	.19

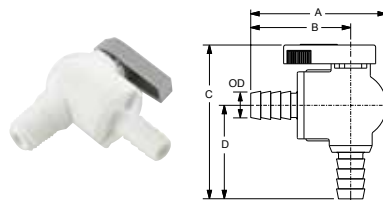

VEU - Parbarb Elbow Ball Valve

PART NO.	HOSE I.D.	O.D.	A	B	C	D	ØE THRU HOLE MIN.
PBPP4VEU4	1/4	.31	2.13	1.57	2.32	1.40	.15
PBPP6VEU6	3/8	.43	2.13	1.60	2.32	1.40	.25
PBPP8VEU8	1/2	.55	2.13	1.60	2.32	1.40	.25

BVC Ball Valve Clip

BV-Clip Shown below holding VUCPB and VME

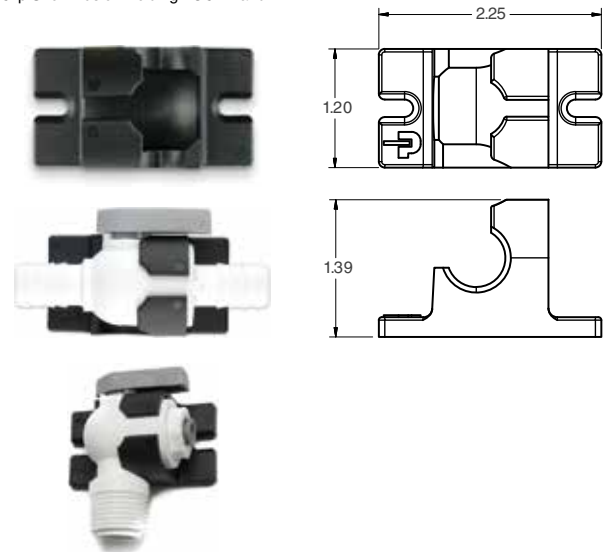



Cartridges

Carstick® Cartridges

LIQUIfit® Cartridges

TrueSeal™ Cartridges

LF3600 Nickel-Plated
Brass

LF3800 Stainless Steel





GOODYEAR
RUBBER PRODUCTS, INC.

☎ 727-342-5088

You can also email us at
GRP@goodyearrubberproducts.com

Cartridges



Parker has developed a range of cartridges guaranteeing the integrity of the sealing system before and after assembly in non-threaded cavities. The compact design of the one-piece cartridges enables automation of your manufacturing process and improves the reliability of your system.

Product Features:

- Self-centering of the cartridge in the cavity
- Push-in connection
- Designed for automation assembly process
- SAE & NSF cartridges available

Markets:

- Industrial
- Pneumatic
- Filtration
- Semi-Conductor
- Life Science
- Automation

Applications:

- Air
- Water
- Beverage Dispensing
- Cab Controls
- Packaging
- Labeling

Specifications:

	Seals	Pressure	Temperature
Carstick	Nitrile	Up to 290 PSI (20 bar)	-4° to +175° F (-20° to +79.4° C)
LF3600 / LF3800	FKM	Up to 435 PSI (30 bar)	-13° to +302° F (-25° to +150° C)
LIQUIfit	EPDM	Up to 230 PSI (15.9 bar)	35° to +200° F (+1.7° to +93.3° C)
TrueSeal	EPDM	Up to 150 PSI (10.3 bar)	-20° to +180° F (-28.9° to +82.2° C)

■ Cartridges

3100

Carstick®
Cartridge Brass
p. C6



3100

Carstick® Cartridge
Nickel-Plated Brass
p. C6



6300

LIQUIfit Cartridge
Brass
p. C8



6300

LIQUIfit Cartridge
Nickel-Plated Brass
p. C8



TSC

Cartridge Insert
p. C10



LF3600

Cartridge
p. C11



LF3800

Cartridge
p. C11



[Click here for CADs, Product Specifications or to Configure Parts Online](#)

Carstick® Cartridges

Component Materials

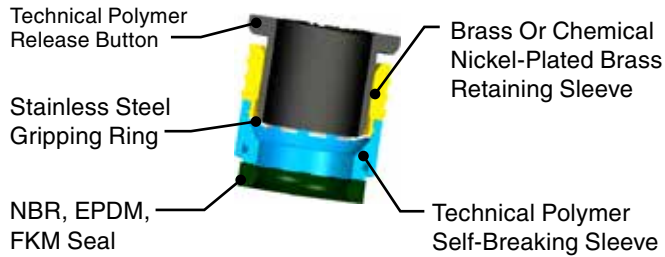

3100 Carstick® Cartridge Brass

PART NO.	OD	G	G1	H	L
3100 04 00	4	8	11	10	554
3100 06 00	6	10	14.5	11.5	629
3100 08 00	8	13	15	15	794
3100 10 00	10	15.5	19.5	17	930
3100 12 00	12	19.5	21	19.5	1038

50 cartridges per Carstick®

3100 Carstick® Cartridge Nickel-Plated Brass Inch

PART NO.	OD	G	G1	H	L
3100 53 00 99	1/8	7	10	9	508
3100 56 00 99	1/4	10.5	14.5	12	600
3100 60 00 99	3/8	15.5	19	16.5	930

50 cartridges per Carstick®
5/32" (4mm) and 5/16" (8mm) also available

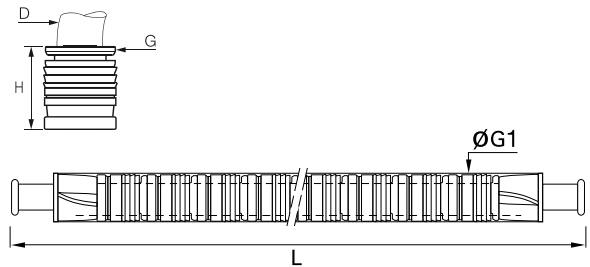

Installation

1. Self-centering of the cartridge in the cavity.
2. The seal protection is broken. The seal slides into the cavity. The cartridge is in place.
3. Tube connection.

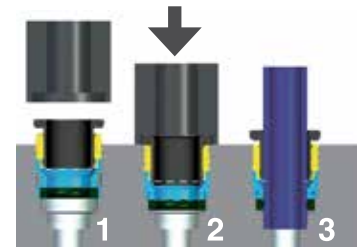

Assembly Tool: For details on the assembly tool, please contact us.

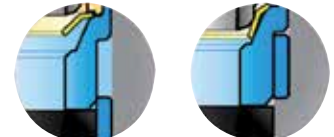

WARNING These products can expose you to chemicals including NICKEL, CARBON BLACK, TITANIUM DIOXIDE, or LEAD, which are known to the state of

Carstick® Cavity Dimensions

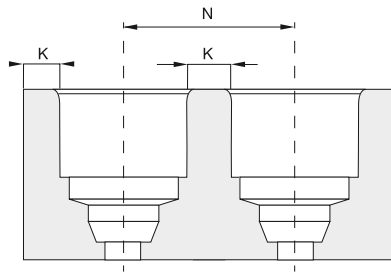
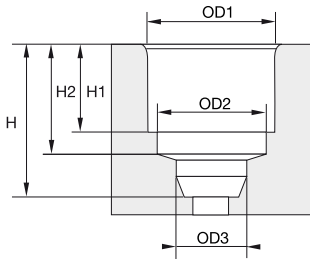

Please consult us for detailed drawings of cavity dimensions and tolerances. All our dimensions are in millimeters.

Carstick® & Quick Fitting Metric

CAVITY	OD3	H	H1	H2
4	4.1	10	6	8.15
6	6.1	12	7.5	9.65
8	8.15	15.5	9.9	12.45
10	10.25	19	11.7	14.35
12	12.17	22	13.9	16.75

Carstick® Inch

CAVITY	OD3	H	H1	H2
1/8	3.25	7.45	5.3	9.5
5/32 *	4.1	8.15	6	10
1/4	6.45	10.15	8	12.5
5/16 *	8.15	12.45	9.9	15.5
3/8	9.65	14.35	11.7	19
1/2	12.8	26.1	16.9	20.1

Polyamide Cavity

CAVITY	OD1	OD2	N*	K
4	8.25	7.05	9.8	1.5
6	10.2	9.15	12.2	2
8	12.15	10.85	14.2	2
10	14.8	13.2	16.8	2
12	17.5	15.5	20	2.5

CAVITY	OD1	OD2	N	K
1/8	7.05	6.02	8.6	1.5
5/32*	8.25	7.05	9.75	1.5
1/4	10.55	9.35	12.6	2
5/16*	12.15	10.85	14.2	2
3/8	14.8	13.1	16.8	2
1/2	19.86	17.82	24.85	2.5

Aluminum Cavity

CAVITY	OD1	OD2	N*	K
4	8.25	7.5	11.5	3
6	10.3	9.15	13.5	3
8	12.2	10.85	15.2	3
10	15.05	13.2	17.1	2
12	17.5	15.5	20	2.5

CAVITY	OD1	OD2	N	K
1/8	7.1	6.2	8.6	1.5
5/32*	8.25	7.05	11.25	3
1/4	10.6	9.35	12.65	2
5/16*	12.2	10.85	15.2	3
3/8	15.05	13.1	17.1	2

Brass Cavity

CAVITY	OD1	OD2	N*	K
4	8.25	7.05	10.25	2
6	10.25	9.1	12.25	2
8	12.2	10.85	14.25	2
10	15.05	13.2	17.1	2
12	17.65	15.5	20	2.5

CAVITY	OD1	OD2	N	K
1/8	7.1	6.2	8.6	1.5
5/32*	8.25	7.05	10.25	2
1/4	10.6	9.35	12.65	2
5/16*	12/2	10.85	14.25	2
3/8	10.05	13.1	17.1	2

* Carstick®

*5/32"=4mm and 5/16"=8mm

LIQUIfit[®] Cartridges



6300 LIQUIfit Cartridge Brass Metric

PART NO.	OD	G	G1	H	L
6300 04 00	4	8	11	10	554
6300 06 00	6	10	14.5	11.5	629
6300 08 00	8	13	15	15	794
6300 10 00	10	15.5	19.5	17	930
6300 12 00	12	18.5	21	19.5	1038

50 cartridges per Carstick[®]

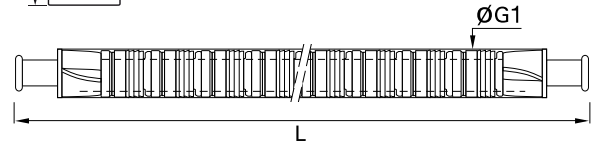
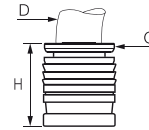

6300 LIQUIfit Cartridge Brass Inch

PART NO.	OD	G	G1	H	L
6300 56 00	1/4	10.5	14.5	12.5	600
6300 60 00	3/8	15.5	19	17	930
6300 62 00	1/2	22	25	23	1038

50 cartridges per Carstick[®]
5/32" (4mm) and 5/16" (8mm) also available

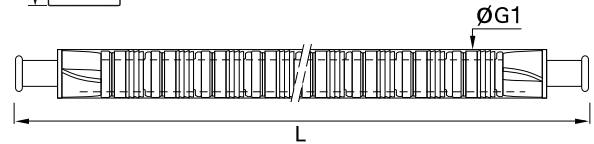
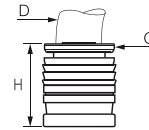

Installation

1. Self-centering of the cartridge in the cavity.
2. The seal protection is broken. The seal slides into the cavity. The cartridge is in place.
3. Tube connection.

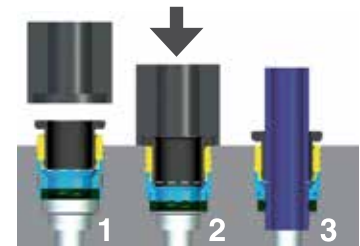

Assembly Tool: For details on the assembly tool, please contact us.



WARNING These products can expose you to chemicals including NICKEL, CARBON BLACK, TITANIUM DIOXIDE, or LEAD, which are known to the state of

[Click here for CADs, Product Specifications or to Configure Parts Online](#)

LIQUIfit® Carstick® Cavity Dimensions

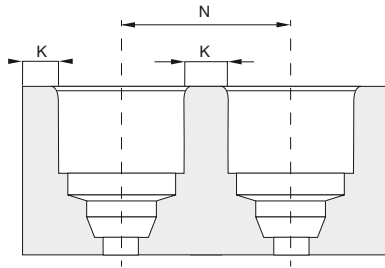
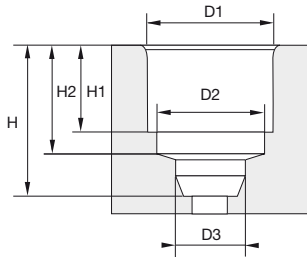

Please consult us for detailed drawings of cavity dimensions and tolerances. All our dimensions are in millimeters.

LIQUIfit® Carstick® Metric

CAVITY	OD3	H	H1	H2
4	4.1	10	6	8.15
6	6.1	12	7.5	9.65
8	8.15	15.5	9.9	12.45
10	10.25	19	11.7	14.35
12	12.17	22	13.9	16.75

LIQUIfit® Carstick® Inch

CAVITY	OD3	H	H1	H2
1/8	3.25	7.45	5.3	9.5
5/32*	4.1	8.15	6	10
1/4	6.45	10.15	8	12.5
5/16*	8.15	12.45	9.9	15.5
3/8	9.65	14.35	11.7	19

Polyamide Cavity

CAVITY	OD1	OD2	N*	K
4	8.25	7.05	9.8	1.5
6	10.2	9.15	12.2	2
8	12.15	10.85	14.2	2
10	14.8	13.2	16.8	2
12	17.5	15.5	20	2.5

CAVITY	OD1	OD2	N	K
1/8	7.05	6.02	8.6	1.5
5/32*	8.25	7.05	9.75	1.5
1/4	10.55	9.35	12.6	2
5/16*	12.15	10.85	14.2	2
3/8	14.8	13.1	16.8	2

Aluminum Cavity

CAVITY	OD1	OD2	N*	K
4	8.25	7.5	11.5	3
6	10.3	9.15	13.5	3
8	12.2	10.85	15.2	3
10	15.05	13.2	17.1	2
12	17.5	15.5	20	2.5

CAVITY	OD1	OD2	N	K
1/8	7.1	6.2	8.6	1.5
5/32*	8.25	7.05	11.25	3
1/4	10.6	9.35	12.65	2
5/16*	12.2	10.85	15.2	3
3/8	15.05	13.1	17.1	2

Brass Cavity

CAVITY	OD1	OD2	N*	K
4	8.25	7.05	10.25	2
6	10.25	9.1	12.25	2
8	12.2	10.85	14.25	2
10	15.05	13.2	17.1	2
12	17.65	15.5	20	2.5

CAVITY	OD1	OD2	N	K
1/8	7.1	6.2	8.6	1.5
5/32*	8.25	7.05	10.25	2
1/4	10.6	9.35	12.65	2
5/16*	12.2	10.85	14.25	2
3/8	10.05	13.1	17.1	2

*5/32"=4mm and 5/16"=8mm

TrueSeal™ Cartridges



TSC - Cartridge Insert

PART NO. WITH EPDM SEAL	NOM. TUBE O.D.	A* DIAMETER ±.002	B DIAMETER ±.003	C DIAMETER ±.003	D DIAMETER MAXIMUM	E DEPTH ±.002	F DEPTH ±.002	G DEPTH ±.002	H* CENTERLINE OF PORTS MINIMUM
ATSC4-MG	1/4	.528	.421	.260	.19	.230	.435	.600	.670
ATSC6-MG	3/8	.632	.545	.385	.31	.280	.455	.705	.790
ATSC8-MG	1/2	.774	.668	.510	.41	.315	.510	.810	1.250

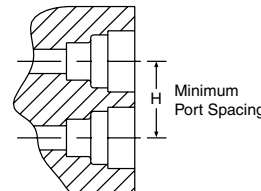
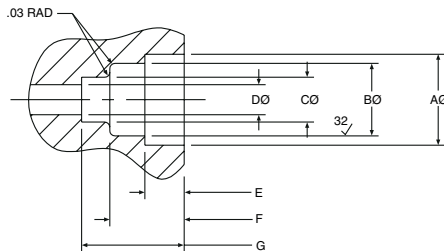

Parker TrueSeal™ Cartridge Inserts:

Allow you to machine or mold a tube connection into your equipment or components. By using cartridge inserts, you will reduce your material and assembly costs, reduce potential leak paths, and give your equipment a new, clean profile by eliminating the need for threaded connections. TSC Cartridge Inserts consist of 1 o-ring, 1 cartridge, and 1 collet.

*Cartridge inserts are rated at 150 PSI in ports dimensioned as above and having Noryl as the receiving material. Other materials may have different ratings and require different port dimensions. Consult the Fluid System Connectors Division when using polypropylene, unfilled polypropylene, ABS or Nylon.

Assembly Instructions:

1. Machine or mold the receiving orifice as per the above dimensions.
2. Place the cartridge insert squarely onto the prepared port opening making sure that the barbs of the cartridge are going into the hole and the lettering on the face of the cartridge is visible.
3. Using a rubber mallet or press, insert the cartridge into the first gland orifice until its face is flush with the top surface of the port.
4. Insert the o-ring into the cartridge and seat it evenly into the second gland orifice.
5. Insert the collet into the cartridge opening.
6. Insert tubing.

WARNING These products can expose you to chemicals including NICKEL, CARBON BLACK, TITANIUM DIOXIDE, or LEAD, which are known to the state of

LF3600 / LF3800 Cartridges

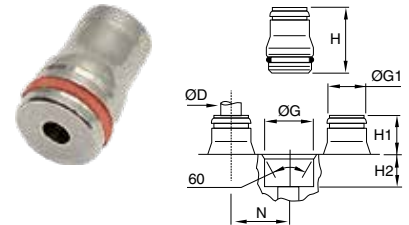
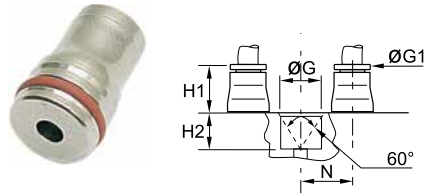

LF3600 Cartridge

PART NO.	TUBE SIZE MM	G + .1 - 0	H1 MM	H2 MM	N MM
PLMC-4M	4	10.00	9.00	8.50	11.00
PLMC-6M	6	12.00	11.00	8.50	13.50
PLMC-8M	8	15.00	12.50	8.50	16.00
PLMC-10M	10	17.50	14.50	10.50	20.00
PLMC-12M	12	19.50	15.00	10.50	22.50
PLMC-14M	14	21.50	16.50	12.00	25.00

LF3800 Cartridge - Metric

PART NO.	TUBE SIZE MM	G + .1 - 0 MM	G1 MM	H MM	H1 MM	H2 MM	N MM
PLSC-4M	4	9.80	8	18.00	9.50	8.50	11.00
PLSC-6M	6	12.10	10	20.00	11.50	8.50	13.50
PLSC-8M	8	14.80	13	22.00	13.50	8.50	16.00
PLSC-10M	10	17.50	15	25.50	15.00	10.50	20.00

WARNING These products can expose you to chemicals including NICKEL, CARBON BLACK, TITANIUM DIOXIDE, or LEAD, which are known to the state of



Industrial Compression Style Fittings

Compression Fittings

Compress-Align® Fittings

Brass Metric Compression

Poly-Tite Fittings





GOODYEAR
RUBBER PRODUCTS, INC.

 **727-342-5088**

You can also email us at
GRP@goodyearrubberproducts.com

■ Compression Fittings

60C
Sleeve
p. D8



60PT
Plastic Sleeve
p. D8



61C
Nut
p. D8



61CL
Long Nut
p. D8



62C
Union
p. D8



62CBH
Bulkhead Union
p. D9



63PT
Tube Support
p. D9, D13



66C
Female Connector
NPT
p. D9



68C
Male Connector
NPTF
p. D9



164C-264C
Union Tee
p. D10



165C-265C
Union Elbow
p. D10



169C-269C
Male Elbow
NPTF
p. D10



170C-270C
Female Elbow
NPT
p. D11



171C
Male Run Tee
NPTF
p. D11



172C
Male Branch Tee
NPTF
p. D11



176C
Adaptor
NPTF
p. D11



177C
Female Branch Tee
NPT
p. D11



179C
45° Male Elbow
NPTF
p. D11



639C
Seal Plug
p. D11



682C
Tank Fitting
NPTF
p. D11



■ Compress-Align® Fittings

59CA
Plug
p. D13



61CA
Nut/Sleeve
p. D13



62CA
Union
p. D13



62CABH
Bulkhead Union
p. D13



62PCA
Union
p. D13



62PCABH
Bulkhead Union
p. D13



63PT
Tube Support
p. D9, D13



66CA
Female Connector
NPT
p. D14



68CA
Male Connector
NPTF
p. D14



164CA-264CA
Union Tee
p. D14



165CA-265CA
Union Elbow
p. D14



169CA-269CA
Male Elbow
NPTF
p. D15



170CA-270CA
Female Elbow
NPT
p. D15



171CA
Male Run Tee
NPTF
p. D15



172CA
Male Branch Tee
NPTF
p. D15



176CA
Adaptor
NPTF
p. D16



177CA
Female Branch Tee
NPT
p. D16



179CA
45° Male Elbow
NPTF
p. D16



639CA
Seal Plug
p. D16



682CA
Tank Fitting
NPTF
p. D16



Brass Metric Compression Fittings

0105
Male Connector
NPT, BSPT
p. D18



0101
Male Elbow
BSPP, Straight
p. D18, D19



0114
Female Connector
BSPP
p. D20



0109
Male Elbow
NPT, BSPT
p. D20, D21



0199
Male Elbow
BSPP
p. D21



0108
Male Branch Tee
BSPT
p. D21



0103
Male Run Tee
BSPT
p. D22



0118
Single Banjo
p. D22, D23



0119
Double Banjo
p. D22, D23



0106
Union
p. D23



0116
Bulkhead Union
p. D23



0102
Union Elbow
p. D24



0104
Union Tee
p. D24



0107
Union Cross
p. D24



0142
Union Y
p. D24



0124
Metric Sleeve
p. D25



0111
Metric Sleeve
p. D25



0110
Metric Nut
p. D25



0110 60
Metric Nut
p. D25



0110 70
Metric Nut Sleeve
p. D27



0125
Metric End Plug
p. D27



0220
Metric Male Plug
p. D27



0168
Reducer
BSPP
p. D27



0127
Metric Tube Support
p. D27



Poly-Tite Fittings

56PSG
Spring guard
p. D29



59P
Plug
p. D29



60P
Plastic Sleeve
p. D29



60PB
Brass Sleeve
p. D29



61P
Nut/Plastic Sleeve
p. D29



61PB
Nut/Brass Sleeve
p. D29



61PN
Nut Only
p. D29



61PSGN
Spring Guard Nut
p. D29



62P
Union
p. D29, D30



62PBH
Bulkhead Union
p. D30



62PCA
Union
p. D30



62PCABH
Bulkhead Union
p. D30



62PTBH
Bulkhead Union
p. D30



66P
Female Connector
NPT
p. D30



68P
Male Connector
NPTF
p. D31



97P
Tube Reducer
p. D31



391P
Coupler Body
p. D31



391PSS
Coupler Body
p. D31



392P
Bulkhead Body
p. D31



392PSS
Bulkhead Body
p. D31



393P
Through Insert
p. D31



393PSS

Through Insert
p. D31



393PD

Shutoff Insert
p. D32



393PDSS

Shutoff Insert
p. D32



394P

Single Shutoff
p. D32



394PSS

Single Shutoff
p. D32



394PD

Double Shutoff
p. D32



394PDSS

Double Shutoff
p. D32



398P

Single Shutoff
p. D32



398PSS

Single Shutoff
p. D32



398PD

Double Shutoff
p. D33



398PDSS

Double Shutoff
p. D33



164P

Union Tee
p. D33



169P-269P

Male Elbow
NPTF
p. D33



169LP

Long Elbow
NPTF
p. D33



169PS

Male Elbow Swivel
NPTF
p. D33



170P

Female Elbow
NPT
p. D34



171P

Male Run Tee
NPTF
p. D34



172P

Male Branch Tee
NPTF
p. D34



177P

Female Branch Tee
NPT
p. D34



NV311P

Needle Valve
NPTF
p. D34



NV312P

Needle Valve
NPTF
p. D34



Compression Fittings



Parker's Compression Fittings provide users with an economical choice with numerous connection options for a wide variety of tube materials without the need for flaring, soldering or other tube preparation necessary to assemble.

Product Features:

- Meets functional requirements of SAE J-512
- UL Listed for flammable liquid
- Brass or acetal sleeve available
- No tube preparation
- Forged and extruded shapes

Markets:

- Industrial
- Packaging
- Pneumatic
- Printing

Applications:

- Air lines
- Lubrication Lines
- Cooling lines
- Industry
- Machinery
- Compressors
- Fluid transfer

Compatible Tubing:

- Copper
- Aluminum
- Thermoplastic tubing



Specifications:

Temperature Range: -65° to +200° F (- 53.8° to +93.3° C)

Pressure Range:

TUBE SIZE	PSI	bar	TUBE SIZE	PSI	bar
1/8	2800	193.0	1/2	750	51.7
3/16	1900	131.0	5/8	650	44.8
1/4	1400	96.5	3/4	550	37.9
5/16	1200	82.7	7/8	450	24.1
3/8	1000	68.9			

Note: Pressures listed in above table are with brass sleeve and copper tubing

Assembly Instructions

1. Slide nut then sleeve onto tubing. The thread end of the nut must face out.
2. Insert tube and bottom on the fitting shoulder
3. Assemble nut to body and tighten "hand tight". Then wrench tighten the number of turns indicated in the table.



FITTING SIZE	TUBE SIZE	TURNS REQUIRED TO SEAL FROM HAND-TIGHT	
		60C WITH SOFT METAL TUBING	60PT WITH THERMOPLASTIC TUBING
2	1/8	1-1/4	—
3	3/16	1-1/4	—
4	1/4	1-1/4	2
5	5/16	1-1/4	2
6	3/8	2-1/4	2
8	1/2	2-1/4	2
10	5/8	2-1/4	2
12	3/4	2-1/4	2
14	7/8	2-1/4	—

Sleeve 60C

REF. SAE 060115

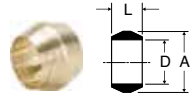

PART NO.	TUBE SIZE	A	D	L
60C-2	1/8	.187	.130	.19
60C-3	3/16	.266	.192	.22
60C-4	1/4	.344	.255	.25
60C-5	5/16	.406	.318	.25
60C-6	3/8	.469	.382	.25
60C-7	7/16	.531	.444	.31
60C-8	1/2	.594	.507	.38
60C-10	5/8	.719	.632	.38
60C-12	3/4	.875	.758	.44
60C-14	7/8	1.000	.883	.41

Long Nut 61CL

REF. SAE 060111

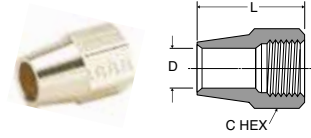

PART NO.	TUBE SIZE	STRAIGHT THREAD	C HEX	D	L
61CL-4	1/4	7/16-24	1/2	.255	.75
61CL-5	5/16	1/2-24	9/16	.318	.84
61CL-6	3/8	9/16-24	5/8	.382	.97
61CL-8	1/2	11/16-20	13/16	.507	1.06
61CL-10	5/8	13/16-18	15/16	.632	1.19
61CL-12	3/4	1-18	1-3/16	.758	1.38

Acetal Sleeve 60PT

PART NO.	PLASTIC TUBE WALL	TUBE WALL	A	D	L
60PT-4	1/4	.040	.375	.254	.19
60PT-5	5/16	.062	.438	.317	.19
60PT-6	3/8	.062	.500	.379	.19
60PT-8	1/2	.062	.631	.507	.25
60PT-10	5/8	.062	.747	.632	.22



Union 62C

REF. SAE 060101 BA

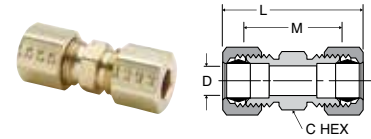

PART NO.	TUBE SIZE	STRAIGHT THREAD	C HEX	L	M	FLOW DIA. D
62C-2	1/8	5/16-24	5/16	1.05	.64	.094
62C-3	3/16	3/8-24	3/8	1.21	.72	.125
62C-4	1/4	7/16-24	7/16	1.33	.79	.188
62C-5	5/16	1/2-24	1/2	1.39	.85	.250
62C-6	3/8	9/16-24	9/16	1.52	.97	.312
62C-7	7/16	5/8-24	5/8	1.70	1.02	.312
62C-8	1/2	11/16-20	11/16	1.90	1.08	.406
62C-10	5/8	13/16-18	13/16	2.06	1.23	.500
62C-12	3/4	1-18	1	2.37	1.41	.562
62C-14	7/8	1-1/8-18	1-1/8	2.07	1.19	.766

Nut 61C

REF. SAE 060110



PART NO.	TUBE SIZE	STRAIGHT THREAD	C HEX	D	L
61C-2	1/8	5/16-24	3/8	.130	.38
61C-3	3/16	3/8-24	7/16	.192	.41
61C-4	1/4	7/16-24	1/2	.255	.44
61C-5	5/16	1/2-24	9/16	.318	.44
61C-6	3/8	9/16-24	5/8	.382	.47
61C-7	7/16	5/8-24	11/16	.444	.50
61C-8	1/2	11/16-20	13/16	.507	.62
61C-10	5/8	13/16-18	15/16	.632	.62
61C-12	3/4	1-18	1-3/16	.758	.69
61C-14	7/8	1-1/8-18	1-1/4	.890	.62

Union Reducers 62C

REF. SAE 060101 BA

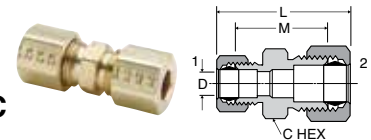

PART NO.	1 TUBE SIZE	2 TUBE SIZE	1 STRAIGHT THREAD	2 STRAIGHT THREAD	C HEX	L	M	FLOW DIA. D
62C-4-3	3/16	1/4	3/8-24	7/16-24	7/16	1.29	.78	.125
62C-6-4	1/4	3/8	7/16-24	9/16-24	9/16	1.46	.91	.188
62C-8-6	3/8	1/2	9/16-24	11/16-20	11/16	1.71	1.03	.312
62C-10-6	3/8	5/8	9/16-24	13/16-18	13/16	1.82	1.13	.312

WARNING These products can expose you to chemicals including LEAD which is known to the state of California

[Click here for CADs, Product Specifications or to Configure Parts Online](#)

Bulkhead Union 62CBH

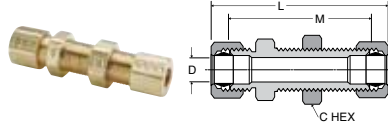

PART NO.	TUBE SIZE	STRAIGHT THREAD	C HEX	L	M	BULKHEAD HOLE DIA.	FLOW DIA. D
62CBH-4	1/4	7/16-24	9/16	2.29	1.75	7/16	.188
62CBH-6	3/8	9/16-24	11/16	2.42	1.88	9/16	.312

Male Connector 68C

REF. SAE 060102 BA

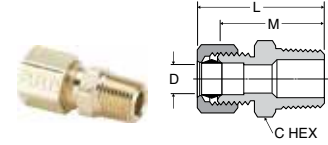

PART NO.	TUBE SIZE	PIPE THREAD	STRAIGHT THREAD	C HEX	L	M	FLOW DIA. D
68C-2-1	1/8	1/16	5/16-24	3/8	.99	.78	.095
68C-2-2	1/8	1/8	5/16-24	7/16	.97	.77	.094
68C-3-1	3/16	1/16	3/8-24	3/8	1.08	.84	.125
68C-3-2	3/16	1/8	3/8-24	7/16	1.08	.84	.125
68C-3-4	3/16	1/4	3/8-24	9/16	1.27	1.03	.125
68C-4-2	1/4	1/8	7/16-24	7/16	1.10	.86	.188
68C-4-4	1/4	1/4	7/16-24	9/16	1.30	1.06	.188
68C-4-6	1/4	3/8	7/16-24	11/16	1.27	1.03	.188
68C-4-8	1/4	1/2	7/16-24	7/8	1.55	1.31	.188
68C-5-2	5/16	1/8	1/2-24	1/2	1.15	.89	.234
68C-5-4	5/16	1/4	1/2-24	9/16	1.33	1.07	.250
68C-6-2	3/8	1/8	9/16-24	9/16	1.25	.97	.250
68C-6-4	3/8	1/4	9/16-24	9/16	1.42	1.14	.312
68C-6-6	3/8	3/8	9/16-24	11/16	1.44	1.16	.312
68C-6-8	3/8	1/2	9/16-24	7/8	1.53	1.25	.312
68C-7-4	7/16	1/4	5/8-24	5/8	1.50	1.17	.312
68C-8-4	1/2	1/4	11/16-20	11/16	1.60	1.20	.312
68C-8-6	1/2	3/8	11/16-20	11/16	1.60	1.20	.406
68C-8-8	1/2	1/2	11/16-20	7/8	1.71	1.31	.406
68C-10-6	5/8	3/8	13/16-18	13/16	1.73	1.31	.406
68C-10-8	5/8	1/2	13/16-18	7/8	1.90	1.48	.500
68C-10-12	5/8	3/4	13/16-18	1-1/16	1.98	1.56	.500
68C-12-8	3/4	1/2	1-18	1	2.05	1.60	.562
68C-12-12	3/4	3/4	1-18	1-1/16	2.08	1.63	.656
68C-14-12	7/8	3/4	1-1/8-18	1-1/8	1.76	1.41	.750

Brass Insert 63PT

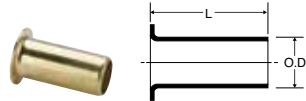

PART NO.	TUBE O.D.	TUBE WALL	L	O.D.
63PT-2-16	1/8	.016	.46	.080
63PT-2-23	1/8	.023	.45	.073
63PT-3-25	3/16	.025	.45	.135
63PT-3-40	3/16	.040	.52	.095
63NTA-4*	1/4		.53	.163
63PT-4-62	1/4	.062	.33	.110
63PT-5-40	5/16	.040	.50	.232
63PT-5-62	5/16	.062	.53	.187
63NTA-6*	3/8		.64	.245
63NTA-8*	1/2		.81	.370
63PT-10-62	5/8	.062	.72	.483

* Denotes 304 stainless steel

Female Connector 66C

REF. SAE 060103 BA

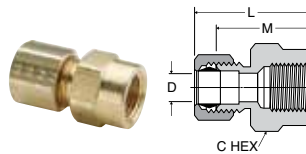

PART NO.	TUBE SIZE	PIPE THREAD	STRAIGHT THREAD	C HEX	L	M	FLOW DIA. D
66C-2-2	1/8	1/8	5/16-24	9/16	.95	.75	.094
66C-3-2	3/16	1/8	3/8-24	9/16	1.02	.78	.125
66C-3-4	3/16	1/4	3/8-24	11/16	1.20	.96	.125
66C-4-2	1/4	1/8	7/16-24	9/16	1.02	.78	.188
66C-4-4	1/4	1/4	7/16-24	11/16	1.24	1.00	.188
66C-5-2	5/16	1/8	1/2-24	9/16	1.07	.81	.250
66C-5-4	5/16	1/4	1/2-24	11/16	1.29	1.03	.250
66C-6-2	3/8	1/8	9/16-24	9/16	1.06	.78	.312
66C-6-4	3/8	1/4	9/16-24	11/16	1.34	1.06	.312
66C-6-6	3/8	3/8	9/16-24	13/16	1.34	1.06	.312
66C-6-8	3/8	1/2	9/16-24	1	1.54	1.27	.312
66C-7-6	7/16	3/8	5/8-24	13/16	1.43	1.09	.312
66C-8-4	1/2	1/4	11/16-20	11/16	1.49	1.09	.406
66C-8-6	1/2	3/8	11/16-20	13/16	1.52	1.12	.406
66C-8-8	1/2	1/2	11/16-20	1	1.71	1.31	.406
66C-10-8	5/8	1/2	13/16-18	1	1.80	1.38	.500

WARNING These products can expose you to chemicals including LEAD which is known to the state of California

Union Tee 164C-264C

REF. SAE 060401 BA

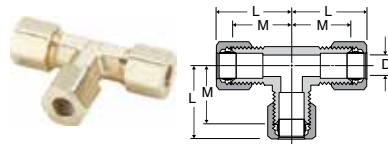

PART NO.	TUBE SIZE	STRAIGHT THREAD	L	M	FLOW DIA. D
164C-2	1/8	5/16-24	.82	.61	.094
264C-3	3/16	3/8-24	.84	.60	.125
164C-4	1/4	7/16-24	.86	.63	.188
264C-4	1/4	7/16-24	.84	.60	.188
164C-5	5/16	1/2-24	.98	.71	.250
164C-6	3/8	9/16-24	1.03	.74	.312
164C-8	1/2	11/16-20	1.34	.93	.406
164C-10	5/8	13/16-18	1.54	1.08	.500
164C-12	3/4	1.00-18	1.65	1.17	.563

Male Elbow 169C-269C

REF. SAE 060202 BA

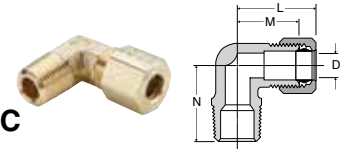

PART NO.	TUBE SIZE	PIPE THREAD	STRAIGHT THREAD	L	M	N	FLOW DIA. D
169C-2-1	1/8	1/16	5/16-24	.81	.60	.67	.095
269C-2-2	1/8	1/8	5/16-24	.80	.60	.67	.094
169C-3-1	3/16	1/16	3/8-24	.85	.61	.67	.126
169C-3-2	3/16	1/8	3/8-24	.84	.61	.69	.125
269C-3-2	3/16	1/8	3/8-24	.84	.60	.67	.125
169C-3-4	3/16	1/4	3/8-24	.86	.64	.93	.125
169C-4-2	1/4	1/8	7/16-24	.86	.61	.74	.188
269C-4-2	1/4	1/8	7/16-24	.84	.60	.73	.188
169C-4-4	1/4	1/4	7/16-24	.86	.62	.94	.188
269C-4-4	1/4	1/4	7/16-24	.84	.60	.79	.188
169C-4-6	1/4	3/8	7/16-24	.93	.68	1.00	.188
169C-5-2*	5/16	1/8	1/2-24	.88	.61	.74	.234
269C-5-2*	5/16	1/8	1/2-24	.86	.60	.73	.250
169C-5-4	5/16	1/4	1/2-24	.95	.71	.93	.250
269C-5-4	5/16	1/4	1/2-24	.93	.67	.82	.250
169C-5-6	5/16	3/8	1/2-24	1.01	.75	1.00	.250
169C-6-2*	3/8	1/8	9/16-24	1.03	.74	.74	.234
269C-6-2*	3/8	1/8	9/16-24	.97	.69	.75	.220
169C-6-4	3/8	1/4	9/16-24	1.03	.74	.93	.312
269C-6-4	3/8	1/4	9/16-24	1.01	.73	.92	.312
169C-6-6	3/8	3/8	9/16-24	1.03	.75	1.00	.312
269C-6-6	3/8	3/8	9/16-24	1.12	.84	.97	.312
169C-6-8	3/8	1/2	9/16-24	1.22	.94	1.27	.312
269C-7-6	7/16	3/8	5/8-24	1.16	.82	.98	.312
169C-8-4*	1/2	1/4	11/16-20	1.34	.94	1.00	.312
169C-8-6	1/2	3/8	11/16-20	1.34	.93	1.11	.406
169C-8-8	1/2	1/2	11/16-20	1.48	1.00	1.37	.406
169C-10-8	5/8	1/2	13/16-18	1.48	1.06	1.31	.500
169C-12-8	3/4	1/2	1-18	1.64	1.18	1.49	.562
169C-12-12	3/4	3/4	1-18	1.70	1.27	1.58	.562

Union Tee 164C-264C Combination Sizes

REF. SAE 060401 BA

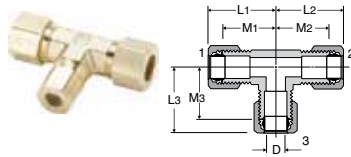

PART NO.	1 TUBE SIZE	2 TUBE SIZE	3 TUBE SIZE	L1	L2	L3	M1	M2	M3	FLOW DIA. D
164C-6-4-4	3/8	1/4	1/4	1.03	.96	.96	.75	.72	.72	.188
164C-6-6-4	3/8	3/8	1/4	1.03	.96	.96	.75	.75	.72	.188
164C-8-8-6	1/2	1/2	3/8	1.34	1.16	1.16	.94	.94	.88	.312

Union Elbow 165C-265C

REF. SAE 060201 BA

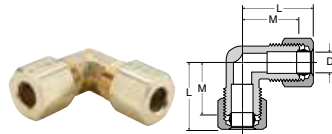

PART NO.	TUBE SIZE	STRAIGHT THREAD	L	M	FLOW DIA. D
165C-2	1/8	5/16-24	.82	.61	.094
165C-3	3/16	3/8-24	.87	.61	.125
165C-4	1/4	7/16-24	.88	.61	.188
265C-4	1/4	7/16-24	.84	.60	.188
165C-5	5/16	1/2-24	.95	.71	.250
165C-6	3/8	9/16-24	1.03	.74	.312
165C-7	7/16	5/3-24	1.16	.82	.312
165C-8	1/2	11/16-20	1.34	.93	.406
165C-10	5/8	13/16-18	1.48	1.05	.500
165C-12	3/4	1-18	1.65	1.17	.563

* For these parts the pipe thread through hole is smaller than the through hole on the flare end.

[Click here for CADs, Product Specifications or to Configure Parts Online](#)

Female Elbow 170C-270C

REF. SAE 060203 BA

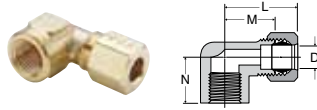

PART NO.	TUBE SIZE	PIPE THREAD	STRAIGHT THREAD	L	M	N	FLOW DIA. D
170C-2-2	1/8	1/8	5/16-24	.89	.69	.56	.094
170C-3-2	3/16	1/8	3/8-24	.98	.69	.56	.125
170C-4-2	1/4	1/8	7/16-24	.93	.69	.56	.188
270C-4-2	1/4	1/8	7/16-24	.91	.67	.54	.188
170C-4-4	1/4	1/4	7/16-24	1.02	.78	.67	.188
170C-6-4	3/8	1/4	9/16-24	1.06	.79	.73	.312
170C-6-6	3/8	3/8	9/16-24	1.22	.89	.69	.312
170C-7-4	7/16	1/4	5/8-24	1.27	.93	.73	.312
170C-8-6	1/2	3/8	11/16-20	1.34	1.00	.69	.406
170C-8-8	1/2	1/2	11/16-20	1.56	1.15	.97	.408
170C-12-12	3/4	3/4	1-18	2.06	1.58	1.58	.563

Adapter Tee 176C

PART NO.	TUBE SIZE	PIPE THREAD	STRAIGHT THREAD	L	M	N	N1	FLOW DIA. D
176C-4-2	1/4	1/8	7/16-24	.93	.69	.75	.66	.188

Female Branch Tee 177C

PART NO.	TUBE SIZE	PIPE THREAD	STRAIGHT THREAD	L	M	N	FLOW DIA. D
177C-4-2	1/4	1/8	7/16-24	.86	.63	.53	.188

Male Run Tee 171C

REF. SAE 060424 BA

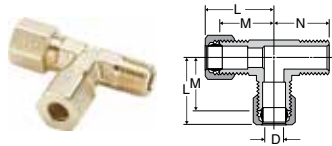

PART NO.	TUBE SIZE	PIPE THREAD	STRAIGHT THREAD	L	M	N	FLOW DIA. D
171C-2-2	1/8	1/8	5/16-24	.82	.61	.67	.094
171C-3-2	3/16	1/8	3/8-24	.86	.61	.67	.125
171C-4-2	1/4	1/8	7/16-24	.90	.64	.75	.188
171C-4-4	1/4	1/4	7/16-24	.93	.69	.92	.188
171C-6-4	3/8	1/4	9/16-24	1.09	.81	1.03	.312

45° Elbow 179C

Compression to male pipe

PART NO.	TUBE SIZE	PIPE THREAD	STRAIGHT THREAD	L	M	N	FLOW DIA. D
179C-4-2	1/4	1/8	7/16-24	.90	.66	.56	.188
179C-4-4	1/4	1/4	7/16-24	.80	.56	.84	.188
179C-6-2	3/8	1/8	9/16-24	.90	.63	.65	.234
179C-6-4	3/8	1/4	9/16-24	.90	.63	.84	.312
179C-6-6	3/8	3/8	9/16-24	.97	.75	.95	.312
179C-8-6	1/2	3/8	11/16-20	1.15	.81	.95	.406

Male Branch Tee 172C

REF. SAE 060425 BA

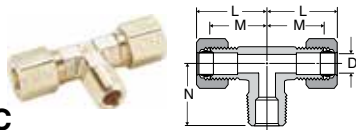

PART NO.	TUBE SIZE	PIPE THREAD	STRAIGHT THREAD	L	M	N	FLOW DIA. D
172C-2-2	1/8	1/8	5/16-24	.82	.61	.67	.094
172C-3-2	3/16	1/8	3/8-24	.86	.61	.67	.125
172C-4-2	1/4	1/8	7/16-24	.86	.61	.74	.188
172C-4-4	1/4	1/4	7/16-24	.93	.69	.92	.188
172C-6-2	3/8	1/8	9/16-24	1.03	.75	.75	.234
172C-6-4	3/8	1/4	9/16-24	1.09	.77	.92	.312
172C-6-6	3/8	3/8	9/16-24	1.09	.81	1.00	.312
172C-8-6	1/2	3/8	11/16-20	1.34	.93	1.10	.406

Seal Plug 639C

PART NO.	TUBE SIZE	STRAIGHT THREAD	C HEX	L	M
639C-4	1/4	7/16-24	7/16	.74	.50

Straight Through Tank Fitting 682C

PART NO.	TUBE SIZE	PIPE THREAD	STRAIGHT THREAD	C HEX	L	M	FLOW DIA. D
682C-3-2	3/16	1/8	3/8-24	7/16	1.06	.84	.195
682C-6-6	3/8	3/8	9/16-24	11/16	1.44	1.16	.387
682C-8-8	1/2	1/2	11/16-20	7/8	1.90	1.31	.516

WARNING These products can expose you to chemicals including LEAD which is known to the state of California



Compress-Align® Fittings

Parker's Compress-Align Fittings are pre-assembled with a captive sleeve, always oriented for a faster installation. The design of the captive sleeve aligns to seal even out-of-round tubing.

Product Features:

- Self-aligning captive sleeve
- 2-piece fitting – Less inventory
- Visible inspection before and after installation
- 1/8" – 1" Sizes
- No flaring, soldering or other tube preparation
- Forged and extruded shapes

Markets:

- Industrial
- Packaging
- Pneumatic
- Printing
- Chemical

Applications:

- Air lines
- Lubrication Lines
- Cooling lines
- Industry
- Machinery
- Chemical Dispensing
- Compressors
- Fluid transfer

Compatible Tubing:

- Copper, Aluminum
- Thermoplastic tubing
- TFE, FEA, PFA

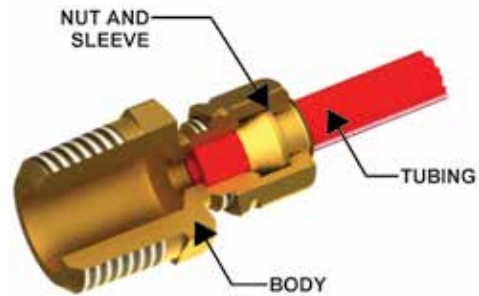

Assembly Instructions

With nut finger tight on fitting body, insert tubing until it bottoms in the Fitting. Complete the seal with one wrench turn for all sizes.



Specifications:

Temperature Range: -65° to +200° F (-53.8° to +93.3° C)

Pressure Range:

TUBE SIZE	PSI	BAR	TUBE SIZE	PSI	BAR
1/8	2800	193.0	1/2	750	51.7
3/16	1900	131.0	5/8	650	44.8
1/4	1400	96.5	3/4	550	37.9
5/16	1200	82.7	7/8	450	31.0
3/8	1000	68.9	1	350	24.1

WARNING These products can expose you to chemicals including LEAD which is known to the state of California to cause cancer.

[Click here for CADs, Product Specifications or to Configure Parts Online](#)

Plug 59CA

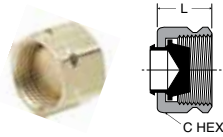

PART NO.	TUBE SIZE	STRAIGHT THREAD	C HEX	L
59CA-4	1/4	7/16-24	1/2	.40
59CA-6	3/8	9/16-24	5/8	.45
59CA-8	1/2	11/16-20	13/16	.50

Nut and Sleeve Assembly 61CA

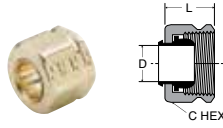

PART NO.	TUBE SIZE	STRAIGHT THREAD	C HEX	D	L
61CA-2	1/8	5/16-24	3/8	.130	.36
61CA-3	3/16	3/8-24	7/16	.194	.38
61CA-4	1/4	7/16-24	1/2	.255	.40
61CA-5	5/16	1/2-24	9/16	.318	.45
61CA-6	3/8	9/16-24	5/8	.382	.45
61CA-8	1/2	11/16-20	13/16	.507	.50
61CA-10	5/8	13/16-18	15/16	.632	.53
61CA-12	3/4	1-18	1-3/16	.760	.56
61CA-14	7/8	1-1/8-18	1-3/8	.885	.68
61CA-16	1	1-1/4-18	1-1/2	1.012	.63

Union 62CA

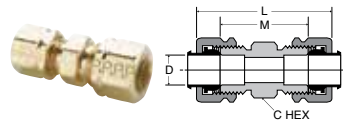

PART NO.	SIZE	STRAIGHT THREAD	C HEX	L	M	FLOW DIA. D
62CA-2	1/8	5/16-24	5/16	1.12	.64	.094
62CA-3	3/16	3/8-24	3/8	1.19	.72	.125
62CA-4	1/4	7/16-24	7/16	1.26	.79	.188
62CA-5	5/16	1/2-24	1/2	1.32	.85	.250
62CA-6	3/8	9/16-24	9/16	1.42	.97	.312
62CA-8	1/2	11/16-20	11/16	1.53	1.08	.406
62CA-10	5/8	13/16-18	13/16	1.71	1.23	.500
62CA-12	3/4	1-18	1	2.20	1.41	.562
62CA-14	7/8	1-1/8-18	1-1/8	2.08	1.19	.766

Union Reducers 62CA

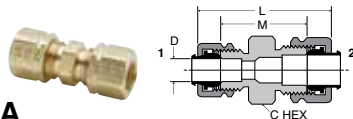

PART NO.	1 TUBE SIZE	2 TUBE SIZE	1 STRAIGHT THREAD	2 STRAIGHT THREAD	C HEX	L	M	FLOW DIA. D
62CA-4-3	3/16	1/4	3/8-24	7/16-24	7/16	1.25	.78	.125
62CA-6-4	1/4	3/8	7/16-24	9/16-24	9/16	1.37	.91	.188
62CA-8-6	3/8	1/2	9/16-24	11/16-20	11/16	1.48	1.03	.312
62CA-10-6	3/8	5/8	9/16-24	13/16-18	13/16	1.59	1.13	.312

Bulkhead Union 62CABH

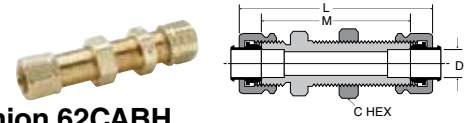

PART NO.	TUBE SIZE	STRAIGHT THREAD	C HEX	L	M	BULKHEAD HOLE DIA.	FLOW DIA. D
62CABH-4	1/4	7/16-24	9/16	2.22	1.75	7/16	.188
62CABH-6	3/8	9/16-24	11/16	2.32	1.88	9/16	.312

Union 62PCA

(Poly-Tite to Compress-Align)

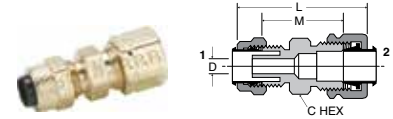

PART NO.	TUBE SIZE	1 STRAIGHT THREAD	2 STRAIGHT THREAD	C HEX	L	M	FLOW DIA. D
62PCA-4	1/4	3/8-24	7/16-24	7/16	1.24	.89	.125
62PCA-5	5/16	7/16-24	1/2-24	1/2	1.26	.92	.144
62PCA-6	3/8	1/2-24	9/16-24	9/16	1.32	.98	.204

Bulkhead Union 62PCABH

(Poly-Tite to Compress-Align)

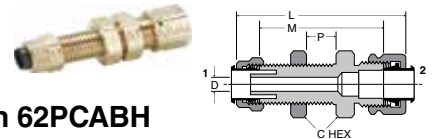

PART NO.	TUBE SIZE	1 STR THD	2 STR THD	C HEX	P MAX	L	M	FLOW BKHD DIA.	FLOW DIA. D
62PCABH-4	1/4	3/8-24	7/16-24	9/16	.38	1.80	1.45	3/8	.125
62PCABH-6	3/8	1/2-24	9/16-24	11/16	.47	1.98	1.64	1/2	.204

Brass Insert 63PT

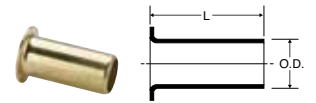

PART NO.	TUBE SIZE	TUBE WALL	L	O.D.
63PT-2-16	1/8	.016	.46	.080
63PT-2-23	1/8	.023	.45	.073
63PT-3-25	3/16	.025	.45	.135
63PT-3-40	3/16	.040	.52	.095
63NTA-4*	1/4		.53	.163
63PT-4-62	1/4	.062	.33	.110
63PT-5-40	5/16	.040	.50	.232
63PT-5-62	5/16	.062	.53	.187
63NTA-6*	3/8		.64	.245
63NTA-8*	1/2		.81	.370
63PT-10-62	5/8	.062	.72	.483

* Denotes 304 stainless steel

WARNING These products can expose you to chemicals including LEAD which is known to the state of California to cause cancer.

[Click here for CADs, Product Specifications or to Configure Parts Online](#)

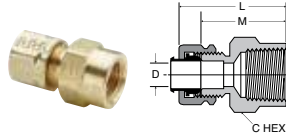

Female Connector 66CA

PART NO.	TUBE SIZE	PIPE THREAD	STRAIGHT THREAD	C HEX	L	M	FLOW DIA. D
66CA-2-2	1/8	1/8	5/16-24	9/16	.99	.75	.094
66CA-3-2	3/16	1/8	3/8-24	9/16	1.01	.78	.125
66CA-3-4	3/16	1/4	3/8-24	11/16	1.19	.96	.125
66CA-4-2	1/4	1/8	7/16-24	9/16	1.02	.78	.188
66CA-4-4	1/4	1/4	7/16-24	11/16	1.24	1.00	.188
66CA-5-2	5/16	1/8	1/2-24	9/16	1.05	.81	.250
66CA-5-4	5/16	1/4	1/2-24	11/16	1.27	1.03	.250
66CA-6-2	3/8	1/8	9/16-24	9/16	1.00	.78	.312
66CA-6-4	3/8	1/4	9/16-24	11/16	1.28	1.06	.312
66CA-6-6	3/8	3/8	9/16-24	13/16	1.29	1.06	.312
66CA-6-8	3/8	1/2	9/16-24	1	1.49	1.27	.312
66CA-8-4	1/2	1/4	11/16-20	11/16	1.32	1.09	.406
66CA-8-6	1/2	3/8	11/16-20	13/16	1.35	1.12	.406
66CA-8-8	1/2	1/2	11/16-20	1	1.54	1.31	.406
66CA-10-8	5/8	1/2	13/16-18	1	1.62	1.38	.500

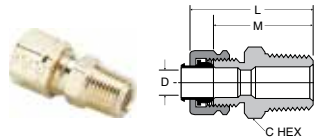

Male Connector 68CA

PART NO.	TUBE SIZE	PIPE THREAD	STRAIGHT THREAD	C HEX	L	M	FLOW DIA. D
68CA-2-1	1/8	1/16	5/16-24	3/8	1.02	.78	.095
68CA-2-2	1/8	1/8	5/16-24	7/16	1.01	.77	.094
68CA-3-1	3/16	1/16	3/8-24	3/8	1.07	.84	.125
68CA-3-2	3/16	1/8	3/8-24	7/16	1.07	.84	.125
68CA-3-4	3/16	1/4	3/8-24	9/16	1.26	1.03	.125
68CA-4-2	1/4	1/8	7/16-24	7/16	1.10	.86	.188
68CA-4-4	1/4	1/4	7/16-24	9/16	1.31	1.06	.188
68CA-4-6	1/4	3/8	7/16-24	11/16	1.28	1.03	.188
68CA-4-8	1/4	1/2	7/16-24	7/8	1.56	1.31	.188
68CA-5-2	5/16	1/8	1/2-24	1/2	1.13	.89	.234
68CA-5-4	5/16	1/4	1/2-24	9/16	1.35	1.07	.250
68CA-6-2	3/8	1/8	9/16-24	9/16	1.19	.97	.250
68CA-6-4	3/8	1/4	9/16-24	9/16	1.36	1.14	.312
68CA-6-6	3/8	3/8	9/16-24	11/16	1.43	1.16	.312
68CA-6-8	3/8	1/2	9/16-24	7/8	1.52	1.25	.312
68CA-8-4	1/2	1/4	11/16-20	11/16	1.45	1.22	.312
68CA-8-6	1/2	3/8	11/16-20	11/16	1.43	1.20	.406
68CA-8-8	1/2	1/2	11/16-20	7/8	1.54	1.31	.406
68CA-10-6	5/8	3/8	13/16-18	13/16	1.55	1.31	.406
68CA-10-8	5/8	1/2	13/16-18	7/8	1.72	1.48	.500
68CA-10-12	5/8	3/4	13/16-18	1-1/16	1.80	1.56	.500
68CA-12-8	3/4	1/2	1-18	1	1.99	1.60	.562
68CA-12-12	3/4	3/4	1-18	1-1/16	2.02	1.63	.656
68CA-14-12	7/8	3/4	1-1/8-18	1-1/8	1.85	1.41	.750
68CA-16-12	1	3/4	1-1/4-18	1-1/4	1.83	1.39	.750
68CA-16-16	1	1	1-1/4-18	1-3/8	2.02	1.58	.875

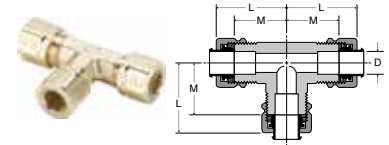

Union Tee 164CA-264CA

PART NO.	TUBE SIZE	STRAIGHT THREAD	L	M	FLOW DIA. D
164CA-2	1/8	5/16-24	.84	.61	.093
264CA-3	3/16	3/8-24	.83	.60	.125
164CA-4	1/4	7/16-24	.84	.63	.188
264CA-4	1/4	7/16-24	.84	.60	.188
164CA-5	5/16	1/2-24	.95	.71	.250
164CA-6	3/8	9/16-24	.96	.74	.312
164CA-8	1/2	11/16-20	1.15	.93	.406
164CA-10	5/8	13/16-18	1.32	1.08	.500
164CA-12	3/4	1.00-18	1.56	1.17	.562

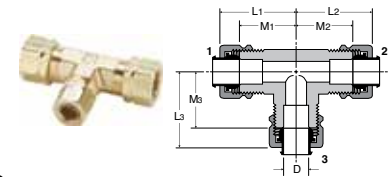

Union Tee 164CA combination sizes

PART NO.	1 TUBE SIZE	2 TUBE SIZE	3 TUBE SIZE	L1	L2	L3	M1	M2	M3	FLOW DIA. D
164CA-6-4-4	3/8	1/4	1/4	.97	.96	.96	.75	.72	.72	.188
164CA-6-6-4	3/8	3/8	1/4	.97	.97	.96	.75	.75	.72	.188
164CA-8-8-6	1/2	1/2	3/8	1.17	1.17	1.10	.94	.94	.88	.312

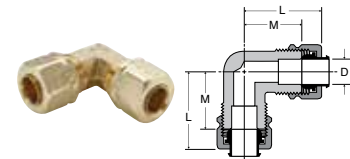

Union Elbow 165CA-265CA

PART NO.	TUBE SIZE	STRAIGHT THREAD	L	M	FLOW DIA. D
165CA-2	1/8	5/16-24	.84	.61	.094
165CA-3	3/16	3/8-24	.84	.61	.125
165CA-4	1/4	7/16-24	.84	.61	.188
265CA-4	1/4	7/16-24	.84	.60	.188
165CA-5	5/16	1/2-24	.94	.71	.250
165CA-6	3/8	9/16-24	.96	.74	.312
165CA-8	1/2	11/16-20	1.15	.93	.406
165CA-10	5/8	13/16-18	1.29	1.05	.500
165CA-12	3/4	1-18	1.56	1.17	.562
165CA-16	1	1-1/4-18	1.63	1.19	.877

WARNING These products can expose you to chemicals including LEAD which is known to the state of California to cause cancer.

[Click here for CADs, Product Specifications or to Configure Parts Online](#)

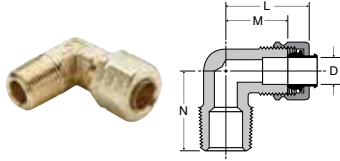

**Male Elbow
169CA-269CA**

PART NO.	TUBE SIZE	PIPE THREAD	STRAIGHT THREAD	L	M	N	FLOW DIA. D
169CA-2-1	1/8	1/16	5/16-24	.84	.60	.67	.095
269CA-2-2	1/8	1/8	5/16-24	.84	.60	.67	.094
169CA-3-1	3/16	1/16	3/8-24	.84	.61	.67	.126
169CA-3-2	3/16	1/8	3/8-24	.84	.61	.69	.125
269CA-3-2	3/16	1/8	3/8-24	.83	.60	.67	.125
169CA-3-4	3/16	1/4	3/8-24	.87	.64	.93	.125
169CA-4-2	1/4	1/8	7/16-24	.84	.61	.74	.188
269CA-4-2	1/4	1/8	7/16-24	.84	.60	.73	.188
169CA-4-4	1/4	1/4	7/16-24	.86	.62	.94	.188
269CA-4-4	1/4	1/4	7/16-24	.84	.60	.79	.188
169CA-4-6	1/4	3/8	7/16-24	.92	.68	1.00	.188
169CA-5-2 *	5/16	1/8	1/2-24	.84	.61	.74	.234
269CA-5-2 *	5/16	1/8	1/2-24	.84	.60	.73	.250
169CA-5-4	5/16	1/4	1/2-24	.94	.71	.93	.250
269CA-5-4	5/16	1/4	1/2-24	.91	.67	.82	.250
169CA-5-6	5/16	3/8	1/2-24	.99	.75	1.00	.250
169CA-6-2 *	3/8	1/8	9/16-24	.96	.74	.74	.234
269CA-6-2 *	3/8	1/8	9/16-24	.96	.69	.75	.220
169CA-6-4	3/8	1/4	9/16-24	.96	.74	.93	.312
269CA-6-4	3/8	1/4	9/16-24	.95	.73	.92	.312
169CA-6-6	3/8	3/8	9/16-24	.97	.75	1.00	.312
269CA-6-6	3/8	3/8	9/16-24	1.06	.84	.97	.312
169CA-6-8	3/8	1/2	9/16-24	1.16	.94	1.27	.312
169CA-8-4 *	1/2	1/4	11/16-20	1.17	.94	1.00	.312
169CA-8-6	1/2	3/8	11/16-20	1.15	.93	1.11	.406
169CA-8-8	1/2	1/2	11/16-20	1.23	1.00	1.37	.406
169CA-10-6 *	5/8	3/8	13/16-18	1.30	1.06	1.15	.406
169CA-10-8	5/8	1/2	13/16-18	1.30	1.06	1.31	.500
169CA-12-8	3/4	1/2	1-18	1.57	1.18	1.49	.562
169CA-12-12	3/4	3/4	1-18	1.66	1.27	1.58	.562
169CA-16-12 *	1	3/4	1-1/4-18	1.63	1.19	1.60	.875

* For these parts the pipe thread through hole is smaller than the through hole on the tube end.

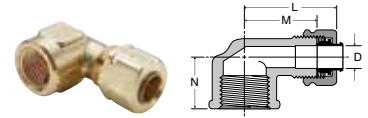

**Female Elbow
170CA-270CA**

PART NO.	TUBE SIZE	PIPE THREAD	STRAIGHT THREAD	L	M	N	FLOW DIA. D
170CA-2-2	1/8	1/8	5/16-24	.93	.69	.56	.094
170CA-3-2	3/16	1/8	3/8-24	.98	.69	.56	.125
170CA-4-2	1/4	1/8	7/16-24	.98	.69	.56	.188
270CA-4-2	1/4	1/8	7/16-24	.91	.67	.54	.188
170CA-4-4	1/4	1/4	7/16-24	1.02	.78	.67	.188
170CA-6-4	3/8	1/4	9/16-24	1.09	.79	.73	.312
170CA-6-6	3/8	3/8	9/16-24	1.16	.89	.69	.312
170CA-8-6	1/2	3/8	11/16-20	1.23	1.00	.69	.406
170CA-8-8	1/2	1/2	11/16-20	1.38	1.15	.97	.408
170CA-12-12	3/4	3/4	1-18	1.97	1.58	1.58	.563

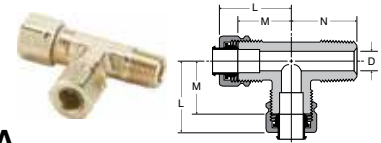

Male Run Tee 171CA

PART NO.	TUBE SIZE	PIPE THREAD	STRAIGHT THREAD	L	M	N	FLOW DIA. D
171CA-2-2	1/8	1/8	5/16-24	.84	.61	.67	.094
171CA-3-2	3/16	1/8	3/8-24	.83	.61	.67	.125
171CA-4-2	1/4	1/8	7/16-24	.88	.64	.75	.188
171CA-4-4	1/4	1/4	7/16-24	.93	.69	.92	.188
171CA-6-4	3/8	1/4	9/16-24	1.03	.81	1.03	.312

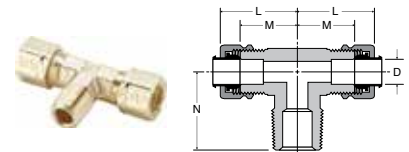

Male Branch Tee 172CA

PART NO.	TUBE SIZE	PIPE THREAD	STRAIGHT THREAD	L	M	N	FLOW DIA. D
172CA-2-2	1/8	1/8	5/16-24	.84	.61	.67	.093
172CA-3-2	3/16	1/8	3/8-24	.83	.61	.67	.125
172CA-4-2	1/4	1/8	7/16-24	.84	.61	.74	.188
172CA-4-4	1/4	1/4	7/16-24	.93	.69	.92	.188
172CA-6-2	3/8	1/8	9/16-24	.97	.75	.75	.234
172CA-6-4	3/8	1/4	9/16-24	.99	.77	.92	.312
172CA-6-6	3/8	3/8	9/16-24	1.07	.81	1.00	.312
172CA-8-6	1/2	3/8	11/16-20	1.15	.93	1.10	.406
172CA-12-12	3/4	3/4	1-18	1.67	1.27	1.50	.562

WARNING These products can expose you to chemicals including LEAD which is known to the state of California to cause cancer.

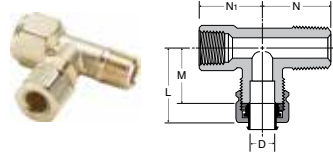

Adapter Tee 176CA

PART NO.	TUBE SIZE	PIPE THREAD	STRAIGHT THREAD	L	M	N	N1	FLOW DIA. D
176CA-4-2	1/4	1/8	7/16-24	.92	.69	.75	.66	.188

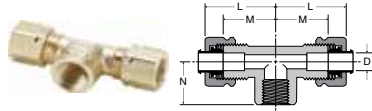

Female Branch Tee 177CA

PART NO.	TUBE SIZE	PIPE THREAD	STRAIGHT THREAD	L	M	N	FLOW DIA. D
177CA-4-2	1/4	1/8	7/16-24	.86	.63	.53	.188

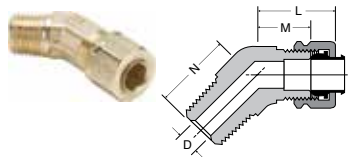

45° Elbow 179CA

PART NO.	TUBE SIZE	PIPE THREAD	STRAIGHT THREAD	L	M	N	FLOW DIA. D
179CA-4-2	1/4	1/8	7/16-24	.89	.66	.56	.188
179CA-4-4	1/4	1/4	7/16-24	.80	.56	.84	.188
179CA-6-2	3/8	1/8	9/16-24	.85	.63	.65	.234
179CA-6-4	3/8	1/4	9/16-24	.85	.63	.84	.312
179CA-6-6	3/8	3/8	9/16-24	.97	.75	.95	.312
179CA-8-6	1/2	3/8	11/16-20	1.03	.81	.95	.406

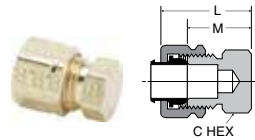

Seal Plug 639CA

PART NO.	TUBE SIZE	STRAIGHT THREAD	C HEX	L	M
639CA-4	1/4	7/16-24	7/16	.74	.50

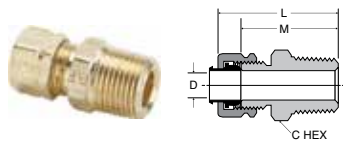

Straight Through Tank Fitting 682CA

PART NO.	TUBE SIZE	PIPE THREAD	STRAIGHT THREAD	C HEX	L	M	FLOW DIA. D
682CA-3-2	3/16	1/8	3/8-24	7/16	1.07	.84	.194

WARNING These products can expose you to chemicals including LEAD which is known to the state of California to cause cancer.

Brass Metric Compression



Parker's Metric Compression Fittings provide users with an economical choice with numerous connection options for a wide variety of tube materials without the need for flaring, soldering or other tube preparation necessary to assemble.

Product Features:

- 4mm – 28mm tube sizes
- NPT, BSPT, BSPP, Metric Threads
- NBR seal
- Silicone free

Markets:

- Factory/Process Automation
- Automotive Process
- Packaging
- Pneumatic
- Printing

Compatible Tubing:

- Copper
- Aluminum
- Thermoplastic tubing

Applications:

- Air lines
- Lubrication Lines
- Cooling lines
- Water
- Machinery
- Compressors
- Fluid transfer

Specifications:

Temperature Range: -40° to +250° F (-40° to +121.1° C)

Pressure Range:

TUBE SIZE MM	PSI	bar	TUBE SIZE MM	PSI	bar
4	3335	229.9	14	652	44.9
6	2175	149.9	16	580	39.9
8	1450	99.9	18	536	36.9
10	1087	74.9	20	507	34.9
12	797	54.9	22	435	29.9

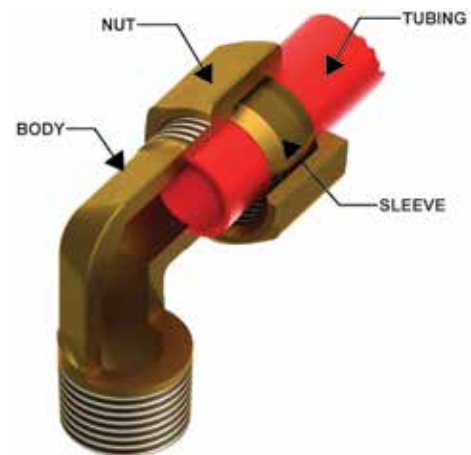

[Click here for CADs, Product Specifications or to Configure Parts Online](#)

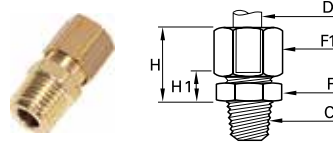

0105 Male Connector BSPT

PART NO.	OD	C	F	F1	H MAX	H1	KG
0105 04 10	4	R1/8	10	10	17	7	.012
0105 05 10	5	R1/8	11	12	17.5	7.5	.016
0105 05 13	5	R1/4	14	12	17.5	7.5	.022
0105 06 10	6	R1/8	11	13	18	7.5	.017
0105 06 13	6	R1/4	14	13	18	7.5	.024
0105 06 17	6	R3/8	17	13	18	8.5	.031
0105 08 10	8	R1/8	13	14	19.5	7	.020
0105 08 13	8	R1/4	14	14	19.5	7	.025
0105 08 17	8	R3/8	17	14	20.5	8	.032
0105 10 10	10	R1/8	17	19	24	9	.043
0105 10 13	10	R1/4	17	19	24	9	.047
0105 10 17	10	R3/8	17	19	24	9	.048
0105 10 21	10	R1/2	22	19	25	10	.067
0105 12 13	12	R1/4	19	22	24	9	.059
0105 12 17	12	R3/8	19	22	24	9	.060
0105 12 21	12	R1/2	22	22	25	10	.076
0105 14 13	14	R1/4	22	24	25	8	.068
0105 14 17	14	R3/8	22	24	25	8	.068
0105 14 21	14	R1/2	22	24	26	9	.080
0105 14 27	14	R3/4	27	24	27	10	.107
0105 15 17	15	R3/8	22	24	25	8	.065
0105 15 21	15	R1/2	22	24	26	9	.076
0105 16 13	16	R1/4	24	27	27	9.5	.092
0105 16 17	16	R3/8	24	27	27	9.5	.092
0105 16 21	16	R1/2	24	27	27	9.5	.099
0105 16 27	16	R3/4	27	27	28	10.5	.123
0105 18 21	18	R1/2	27	30	30	10.5	.127
0105 18 27	18	R3/4	27	30	30	10.5	.138
0105 20 21	20	R1/2	30	32	32	11	.148
0105 20 27	20	R3/4	30	32	32	11	.157
0105 22 21	22	R1/2	32	36	33	11	.187
0105 22 27	22	R3/4	32	36	33	11	.196
0105 22 34	22	R1	36	36	33	11	.227
0105 25 27	25	R3/4	36	41	36	11	.261
0105 25 34	25	R1	36	41	36	11	.278
0105 28 27	28	R3/4	41	42	36	11	.274
0105 28 34	28	R1	41	42	36	11	.283

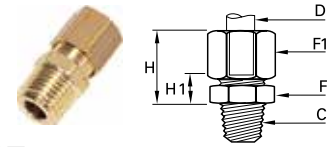

0105 Male Connector NPT

PART NO.	OD	C	F	F1	H MAX	H1	KG
0105 06 11	6	NPT1/8	11	13	18	7.5	.018
0105 06 14	6	NPT1/4	14	13	18	7.5	.027
0105 08 11	8	NPT1/8	13	14	21	7	.021
0105 08 14	8	NPT1/4	14	14	18.5	7	.026
0105 10 14	10	NPT1/4	17	19	24	9	.048
0105 10 18	10	NPT3/8	17	19	24	9	.048
0105 10 22	10	NPT1/2	22	19	25	10	.066

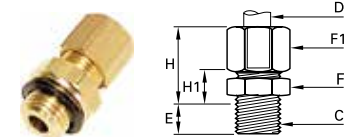

0101 Male Connector with Captive Sealing Washer Male BSP

PART NO.	OD	C	E	F	F1	H MAX	H1	KG
0101 04 19	4	M5X0.8	5	10	10	16.5	8	.011
0101 04 10	4	G1/8	6.5	13	10	16.5	8	.016
0101 05 10	5	G1/8	6.5	13	12	17.5	8.5	.018
0101 06 10	6	G1/8	6.5	13	13	18	8.5	.020
0101 06 13	6	G1/4	8	17	13	18	9.5	.030
0101 08 10	8	G1/8	6.5	13	14	19	8.5	.021
0101 08 13	8	G1/4	8	17	14	19.5	9	.032
0101 08 17	8	G3/8	11	22	14	20	10.5	.044
0101 10 13	10	G1/4	8	17	19	24	11	.049
0101 10 17	10	G3/8	11	22	19	24	11.5	.061
0101 12 13	12	G1/4	8	19	22	24	11	.062
0101 12 17	12	G3/8	11	22	22	24	11.5	.069
0101 12 21	12	G1/2	12	27	22	24	12	.089
0101 14 17	14	G3/8	11	22	24	25	10.5	.074
0101 14 21	14	G1/2	12	27	24	25	11	.094
0101 15 17	15	G3/8	11	22	24	25	10.5	.071
0101 15 21	15	G1/2	12	27	24	25	11	.093
0101 16 17	16	G3/8	11	22	27	27	12	.092
0101 16 21	16	G1/2	12	27	27	27	12.5	.109
0101 18 21	18	G1/2	12	27	30	29.5	12.5	.128
0101 18 27	18	G3/4	13	32	30	29.5	13	.152
0101 20 27	20	G3/4	13	32	32	31	13	.164
0101 22 27	22	G3/4	13	32	36	32	13	.195
0101 22 34	22	G1	15	41	36	31	13.5	.259
0101 25 27	25	G3/4	13	36	41	35.5	13	.261
0101 25 34	25	G1	15	41	41	35.5	13	.169
0101 28 34	28	G1	15	41	42	35.5	13.5	.300

With pre-assembled captive polymer sealing washer

WARNING These products can expose you to chemicals including LEAD which is known to the state of California

[Click here for CADs, Product Specifications or to Configure Parts Online](#)

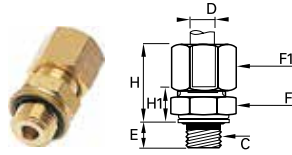

0101 Male Connector with Bi-Material Seal Male BSPP

PART NO.	OD	C	E	F	F1	H MAX	H1	KG
0101 04 10 39	4	G1/8	5.5	13	10	17.5	9	.016
0101 05 10 39	5	G1/8	5.5	13	12	18.5	9.5	.019
0101 06 10 39	6	G1/8	5.5	13	13	19	9.5	.020
0101 06 13 39	6	G1/4	7	17	13	19	10.5	.030
0101 08 10 39	8	G1/8	5.5	13	14	20	9.5	.022
0101 08 13 39	8	G1/4	7	17	14	20.5	10	.032
0101 08 17 39	8	G3/8	9.5	22	14	21.5	12	.045
0101 10 13 39	10	G1/4	7	17	19	25	12	.048
0101 10 17 39	10	G3/8	9.5	22	19	25.5	13	.062
0101 12 13 39	12	G1/4	7	19	22	25	12	.063
0101 12 17 39	12	G3/8	9.5	22	22	25	13	.071
0101 12 21 39	12	G1/2	10.5	27	22	25	13.5	.091
0101 14 17 39	14	G3/8	9.5	22	24	26.5	12	.075
0101 14 21 39	14	G1/2	10.5	27	24	26.5	12.5	.095
0101 15 17 39	15	G3/8	9.5	22	24	26.5	12	.073
0101 15 21 39	15	G1/2	10.5	27	24	26.5	12.5	.095
0101 16 17 39	16	G3/8	9.5	22	27	28.5	13.5	.092
0101 16 21 39	16	G1/2	10.5	27	27	28.5	14	.111
0101 18 21 39	18	G1/2	10.5	27	30	31	14	.129
0101 18 27 39	18	G3/4	11.5	32	30	31	14.5	.155
0101 20 27 39	20	G3/4	11.5	32	32	32.5	14.5	.164
0101 22 27 39	22	G3/4	11.5	32	36	32.5	14.5	.197
0101 22 34 39	22	G1	13	41	36	33	15.5	.259
0101 25 34 39	25	G1	13	41	41	37.5	15.5	.309
0101 28 34 39	28	G1	13	41	42	37.5	15.5	.301

Zinc plated steel with NBR seal

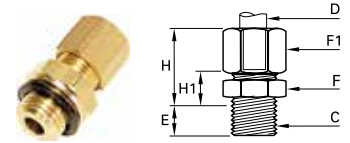

0101 Male Connector Metric Thread

PART NO.	OD	C	E	F	F1	H MAX	H1	KG
0101 04 55	4	M7X1	6.5	10	10	16.5	7.5	.012
0101 04 56	4	M8X1	6.5	11	10	16.5	7.5	.013
0101 05 56	5	M8X1	6.5	11	12	17.5	8	.016
0101 05 60	5	M10X1	6.5	14	12	17.5	8.5	.020
0101 06 60	6	M10X1	6.5	14	13	18	8.5	.021
0101 06 62	6	M10X1.5	6.5	14	13	18	8.5	.021
0101 08 65	8	M12X1	8	17	14	19.5	9	.029
0101 08 66	8	M12X1.25	8	17	14	19.5	9	.029
0101 08 68	8	M13X1.25	8	17	14	19.5	9	.030
0101 10 70	10	M14X1.25	8	17	19	24	11	.047
0101 10 71	10	M14X1.5	8	17	19	24	11	.047
0101 10 74	10	M16X1.25	9	19	19	24	11	.051
0101 10 75	10	M16X1.5	9	19	19	24	11	.051
0101 10 78	10	M18X1.5	9	22	19	24	11.5	.060
0101 12 74	12	M16X1.25	9	19	22	24	11	.061
0101 12 75	12	M16X1.5	9	19	22	24	11	.061
0101 12 78	12	M18X1.5	9	22	22	24	11.5	.070
0101 14 78	14	M18X1.5	9	22	24	25	10.5	.077
0101 14 80	14	M20X1.5	10	24	24	25	11	.084
0101 15 78	15	M18X1.5	9	22	24	25	10.5	.071
0101 16 80	16	M20X1.5	10	24	27	27	12.5	.102
0101 16 82	16	M22X1.5	10	27	27	27	12.5	.111
0101 18 82	18	M22X1.5	10	27	30	29.5	12.5	.129
0101 18 83	18	M24X1.5	11	30	30	29.5	13	.142

WARNING These products can expose you to chemicals including LEAD which is known to the state of California

[Click here for CADs, Product Specifications or to Configure Parts Online](#)

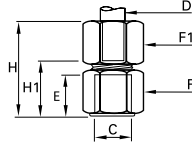

0114 Female Connector BSPP

PART NO.	OD	C	E	F	F1	H MAX	H1	KG
0114 04 10	4	G1/8	9.5	14	10	26	16.5	.020
0114 04 13	4	G1/4	13.5	17	10	30	20.5	.030
0114 05 10	5	G1/8	9.5	14	12	28	17	.023
0114 05 13	5	G1/4	13.5	17	12	31	21	.033
0114 06 10	6	G1/8	9.5	14	13	28	17	.025
0114 06 13	6	G1/4	13.5	17	13	32	21	.034
0114 06 17	6	G3/8	14	22	13	32	21.5	.051
0114 08 10	8	G1/8	9.5	14	14	29	16.5	.026
0114 08 13	8	G1/4	13.5	17	14	33	20.5	.036
0114 08 17	8	G3/8	14	22	14	34	21	.052
0114 10 13	10	G1/4	13.5	17	19	37	21.5	.052
0114 10 17	10	G3/8	14	22	19	37	22	.068
0114 10 21	10	G1/2	18.5	27	19	42	26.5	.099
0114 12 13	12	G1/4	13.5	19	22	36	20.5	.069
0114 12 17	12	G3/8	14	22	22	37	22	.078
0114 12 21	12	G1/2	18.5	27	22	42	26.5	.109
0114 14 13	14	G1/4	13.5	22	24	36	18.5	.085
0114 14 17	14	G3/8	14	22	24	38	21	.048
0114 14 21	14	G1/2	18.5	27	24	43	25.5	.113
0114 15 17	15	G3/8	14	22	24	38	21	.078
0114 15 21	15	G1/2	18.5	27	24	43	25.5	.109
0114 16 13	16	G1/4	13.5	24	27	36	18	.107
0114 16 17	16	G3/8	14	24	27	38	20.5	.106
0114 16 21	16	G1/2	18.5	27	27	44	26	.127
0114 18 17	18	G3/8	14	27	30	39	19.5	.140
0114 18 21	18	G1/2	18.5	27	30	45	26	.144
0114 18 27	18	G3/4	19.5	32	30	46	27	.165
0114 20 17	20	G3/8	14	30	32	38	18	.161
0114 20 21	20	G1/2	18.5	30	32	44.5	24	.173
0114 20 27	20	G3/4	19.5	32	32	47	26.5	.170
0114 22 27	22	G3/4	19.5	32	36	48	26.5	.204
0114 25 27	25	G3/4	19.5	36	41	50.5	26	.297

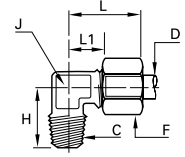

0109 Male Elbow BSPT

PART NO.	OD	C	F	H	J	L MAX	L1	KG
0109 04 10	4	R1/8	10	17	8	19	9.5	.016
0109 04 13	4	R1/4	10	20	10	19	11	.026
0109 05 10	5	R1/8	12	17.5	8	21	11	.019
0109 05 13	5	R1/4	12	21.5	10	22	12	.028
0109 06 10	6	R1/8	13	18	8	22	11	.021
0109 06 13	6	R1/4	13	21.5	10	22	12	.031
0109 08 10	8	R1/8	14	18.5	10	28	15	.028
0109 08 13	8	R1/4	14	22	10	28	15	.033
0109 08 17	8	R3/8	14	24	12	28	15	.044
0109 10 13	10	R1/4	19	25	12	30	14.5	.052
0109 10 17	10	R3/8	19	25.5	12	30	14.5	.060
0109 10 21	10	R1/2	19	32	19	36	21	.109
0109 12 13	12	R1/4	22	26	15	30	15	.074
0109 12 17	12	R3/8	22	27	15	30	15	.077
0109 12 21	12	R1/2	22	32	19	36	21	.116
0109 14 17	14	R3/8	24	30	19	35	18	.105
0109 14 21	14	R1/2	24	32	19	35	18	.112
0109 15 17	15	R3/8	24	30	19	35	18	.099
0109 15 21	15	R1/2	24	32	19	35	18	.106
0109 16 17	16	R3/8	27	30	19	39	21	.120
0109 16 21	16	R1/2	27	33.5	19	39	21	.130
0109 16 27	16	R3/4	27	36.5	23	41	23	.189
0109 18 21	18	R1/2	30	35.5	23	41	21.5	.182
0109 18 27	18	R3/4	30	36.5	23	41	21.5	.199
0109 20 21	20	R1/2	32	36.5	23	42	21.5	.181
0109 20 27	20	R3/4	32	38	23	42	21.5	.200
0109 22 27	22	R3/4	36	40	27	50	30	.288
0109 22 34	22	R1	36	44	27	50	30	.342
0109 25 34	25	R1	41	44	27	54	30	.367
0109 28 34	28	R1	42	48	32	54	30	.384

WARNING These products can expose you to chemicals including LEAD which is known to the state of California

[Click here for CADs, Product Specifications or to Configure Parts Online](#)

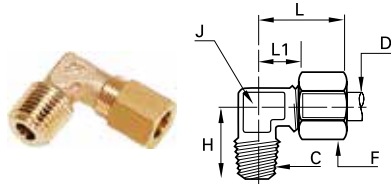

0109 Male Elbow NPT

PART NO.	OD	C	F	H	J	L MAX	L1	KG
0109 06 11	6	1/8	13	18	8	22	11	.021
0109 06 14	6	1/4	13	21.5	10	22	12	.030
0109 08 11	8	1/8	14	18.5	10	28	15	.028
0109 08 14	8	1/4	14	22	10	28	15	.033
0109 10 14	10	1/4	19	25	12	30	14.5	.053

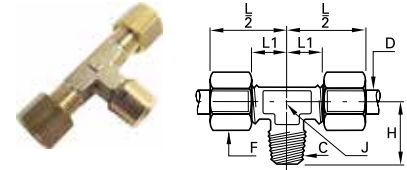

0108 Male Branch Tee Male BSPT

PART NO.	OD	C	F	H	J	L1	L2	KG
0108 04 10	4	R1/8	10	17	8	9.5	19	.025
0108 05 10	5	R1/8	12	17.5	8	11	21	.017
0108 06 10	6	R1/8	13	18	8	11	22	.032
0108 06 13	6	R1/4	13	21.5	10	16	27	.047
0108 08 10	8	R1/8	14	18.5	10	15	28	.045
0108 08 13	8	R1/4	14	22	10	15	28	.050
0108 08 17	8	R3/8	14	24	12	15	28	.061
0108 10 13	10	R1/4	19	25	12	14.5	30	.084
0108 10 17	10	R3/8	19	25.5	12	14.5	30	.090
0108 12 13	12	R1/4	22	26	15	15	30	.116
0108 12 17	12	R3/8	22	27	15	15	30	.117
0108 14 17	14	R3/8	24	30	19	18	35	.153
0108 14 21	14	R1/2	24	32	19	18	35	.168
0108 16 17	16	R3/8	27	30	19	21	39	.190
0108 16 21	16	R1/2	27	33.5	19	21	39	.203
0108 18 21	18	R1/2	30	35.5	23	21.5	41	.265
0108 18 27	18	R3/4	30	36.5	23	21.5	41	.292
0108 20 27	20	R3/4	32	38	23	21.5	42	.298
0108 22 27	22	R3/4	36	40	27	29	50	.435
0108 22 34	22	R1	36	44	27	29	50	.466

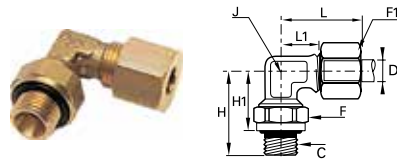

0199 Adjustable Male Elbow BSPP

PART NO.	OD	C	F	F1	H	H1	H1 MAX	J	L MAX	L1	KG
0199 04 10	4	G1/8	14	10	23	16	17	8	19	9.5	.023
0199 04 13	4	G1/4	19	10	30.5	22	23.5	10	19	11	.043
0199 06 10	6	G1/8	14	13	23	16	17	8	22	11	.027
0199 06 13	6	G1/4	19	13	30.5	22	23.5	10	22	12	.047
0199 08 10	8	G1/8	14	14	24	17	18	10	28	15	.033
0199 08 13	8	G1/4	19	14	30.5	22	23.5	10	28	15	.051
0199 08 17	8	G3/8	22	14	33.5	24	25.5	12	28	15	.065
0199 10 13	10	G1/4	19	19	31	22.5	24	12	30	14.5	.068
0199 10 17	10	G3/8	22	19	33.5	24	25.5	12	30	14.5	.079
0199 10 21	10	G1/2	27	19	40	29.5	31	19	37	22	.138
0199 14 17	14	G3/8	22	24	35.5	26	27.5	19	35	18	.119
0199 14 21	14	G1/2	27	24	40	29.5	31	19	35	18	.141
0199 18 21	18	G1/2	27	30	40	29	30.5	23	41	21.5	.187
0199 18 27	18	G3/4	32	30	43.5	32	33.5	23	41	21.5	.222
0199 22 27	22	G3/4	32	36	45.5	34	36	32	51	31	.382
0199 22 34	22	G1	41	36	54	40.5	43	32	51	31	.408
0199 28 34	28	G1	41	42	54	40.5	43	32	54	30	.420

The body will orientate for positioning purposes

WARNING These products can expose you to chemicals including LEAD which is known to the state of California

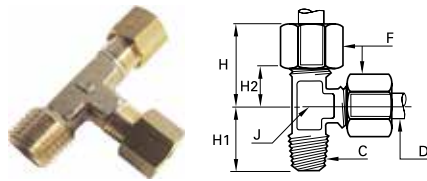

0103 Male Run Tee BSPT

PART NO.	OD	C	F	H MAX	H1	H2	J	KG
0103 04 10	4	R1/8	10	19	17	9.5	8	.025
0103 06 10	6	R1/8	13	22	18	11	8	.033
0103 06 13	6	R1/4	13	27	21.5	16	10	.048
0103 08 13	8	R1/4	14	28	22	15	10	.050
0103 08 17	8	R3/8	14	28	24	15	12	.061
0103 10 13	10	R1/4	19	30	25	14.5	12	.084
0103 12 13	12	R1/4	22	30	26	15	15	.114
0103 14 17	14	R3/8	24	35	30	18	19	.161
0103 14 21	14	R1/2	24	35	32	18	19	.169
0103 15 17	15	R3/8	24	35	30	18	19	.148
0103 15 21	15	R1/2	24	35	32	18	19	.158
0103 16 17	16	R3/8	27	39	30	21	19	.192
0103 18 21	18	R1/2	30	41	35.5	21.5	23	.269
0103 18 27	18	R3/4	30	41	36.5	21.5	23	.282
0103 20 27	20	R3/4	32	42	38	21.5	23	.298
0103 22 27	22	R3/4	36	50	40	29	27	.435
0108 22 34	22	R1	36	44	27	29	50	.466

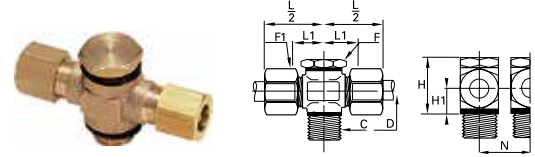

0119 Double Banjo with Captive Sealing Washer Male BSPP

PART NO.	OD	C	F	F1	H	H1	L1	L2	N	KG
0119 06 10	6	G1/8	14	13	24	9.5	14.5	25	17.5	.056
0119 08 13	8	G1/4	17	14	25	10	15.5	28	21	.074
0119 08 17	8	G3/8	22	14	32	13	18	30.5	26.5	.140
0119 10 13	10	G1/4	17	19	31	13	19	34	23	.156
0119 10 17	10	G3/8	22	19	32	13	19	34	26.5	.165
0119 12 13	12	G1/4	17	22	34	14.5	19	34	23	.180
0119 12 17	12	G3/8	22	22	35	14.5	19	34	26.5	.182
0119 14 13	14	G1/4	17	24	37	16	20.5	37.5	28	.246
0119 14 17	14	G3/8	22	24	38	16	20.5	37.5	28	.247
0119 14 21	14	G1/2	27	24	40	16	20.5	38	32.5	.219

Zinc plated steel with NBR seal. Thread with pre-assembled polymer washer

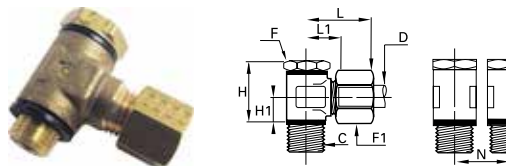

0118 Single Banjo with Captive Sealing Washer Male BSPP

PART NO.	OD	C	F	F1	H	H1	L1 MAX	L1	N	KG
0118 05 10	5	G1/8	14	12	24	9.5	25	14.5	17.5	.041
0118 05 13	5	G1/4	17	12	25	10	26	16	21	.058
0118 14 13	14	G1/4	17	24	37	16	37	20.5	28	.154
0118 14 17	14	G3/8	22	24	38	16	37	20.5	28	.195
0118 14 21	14	G1/2	27	24	40	16	38	20.5	32.5	.208
0118 15 17	15	G3/8	22	24	38	16	37	20.5	28	.190
0118 15 21	15	G1/2	27	24	40	16	38	20.5	32.5	.198
0118 16 21	16	G1/2	27	27	42	16	38	21	32.5	.221
0118 18 21	18	G1/2	27	30	46	19.5	43	24.5	36	.366
0118 20 27	20	G3/4	32	32	49	20	44	24.5	39	.403
0118 22 27	22	G3/4	32	36	53	22	45	24.5	39	.459

With pre-assembled captive polymer sealing washer

WARNING These products can expose you to chemicals including LEAD which is known to the state of California

[Click here for CADs, Product Specifications or to Configure Parts Online](#)

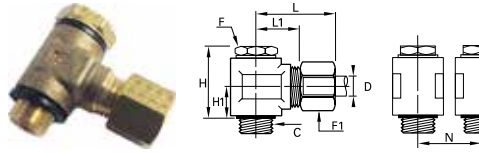

0118 Single Banjo with Bi-Material Seal Male BSPP

PART NO.	OD	C	F	F1	H	H1	L1 MAX	L1	N	KG
0118 04 10 39	4	G1/8	14	10	23	9.5	24	14.5	17.5	.038
0118 05 10 39	5	G1/8	14	12	23	9.5	25	14.5	17.5	.041
0118 05 13 39	5	G1/4	17	12	24	10	26	16	21	.064
0118 06 10 39	6	G1/8	14	13	23	9.5	25	14.5	17.5	.042
0118 06 13 39	6	G1/4	17	13	24	10	26	16	21	.057
0118 08 10 39	8	G1/8	14	14	23	9.5	28	15.5	17.5	.055
0118 08 13 39	8	G1/4	17	14	24	10	28	15.5	21	.058
0118 08 17 39	8	G3/8	22	14	31.5	13.5	30	18	26.5	.113
0118 10 13 39	10	G1/4	17	19	30	13	34	19	23	.118
0118 10 17 39	10	G3/8	22	19	31.5	13.5	34	19	26.5	.128
0118 12 13 39	12	G1/4	17	22	33	14.5	34	19	23	.128
0118 12 17 39	12	G3/8	22	22	34.5	15	34	19	26.5	.140
0118 14 13 39	14	G1/4	17	24	36	16	37	20.5	28	.189
0118 14 17 39	14	G3/8	22	24	37.5	16.5	37	20.5	28	.198
0118 14 21 39	14	G1/2	27	24	39	16.5	38	20.5	32.5	.205
0118 15 17 39	15	G3/8	22	24	37.5	16.5	37	20.5	28	.389
0118 15 21 39	15	G1/2	27	24	40	16.5	38	20.5	32.5	.202
0118 16 21 39	16	G1/2	27	27	40	16.5	38	21	32.5	.225
0118 18 21 39	18	G1/2	27	30	47	20	43	24.5	36	.369
0118 20 27 39	20	G3/4	32	32	50	20.5	44	24.5	39	.394
0118 22 27 39	22	G3/4	32	36	54	22.5	45	24.5	39	.462

Zinc plated steel with NBR seal

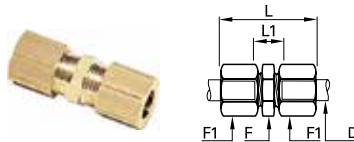

0106 Equal Tube-to-Tube Connector

PART NO.	OD	F	F1	L MAX	L1	KG
0106 04 00	4	10	10	28	10	.016
0106 05 00	5	11	12	31	11	.023
0106 06 00	6	11	13	32	11	.026
0106 08 00	8	13	14	36	10	.031
0106 10 00	10	17	19	42	13	.070
0106 12 00	12	19	22	42	13	.092
0106 14 00	14	22	24	45	11	.104
0106 15 00	15	22	24	45	11	.097
0106 16 00	16	24	27	48	13	.141
0106 18 00	18	27	30	53	14	.186
0106 20 00	20	30	32	56	14	.211
0106 22 00	22	32	36	60	14	.283
0106 25 00	25	36	41	64	14	.396
0106 28 00	28	41	42	64	14	.399

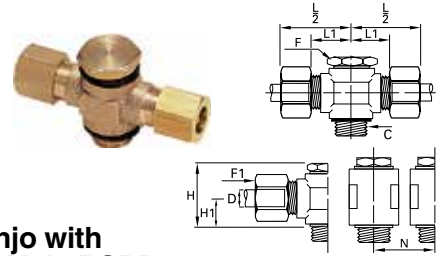

0119 Double Banjo with Bi-Material Seal Male BSPP

PART NO.	OD	C	F	F1	H	H1	L1	L2	N	KG
0119 04 10 39	4	G1/8	14	10	23	9.5	14.5	24	17.5	.050
0119 05 10 39	5	G1/8	14	12	23	9.5	14.5	25	17.5	.049
0119 05 13 39	5	G1/4	17	12	24	10	126	26	21	.072
0119 06 10 39	6	G1/8	14	13	23	9.5	14.5	25	17.5	.056
0119 06 13 39	6	G1/4	17	13	24	10	16	26	21	.071
0119 08 10 39	8	G1/8	14	14	23	9.5	15.5	28	17.5	.072
0119 08 13 39	8	G1/4	17	14	24	10	15.5	28	21	.080
0119 08 17 39	8	G3/8	22	14	31.5	13.5	18	30	26.5	.118
0119 10 13 39	10	G1/4	17	19	30	13	19	34	23	.156
0119 10 17 39	10	G3/8	22	19	31.5	13.5	19	34	26.5	.167
0119 12 13 39	12	G1/4	17	22	33	14.5	19	34	23	.180
0119 12 17 39	12	G3/8	22	22	34.5	15	19	34	26.5	.183
0119 14 13 39	14	G1/4	17	24	36	16	20.5	37	28	.248
0119 14 17 39	14	G3/8	22	24	37.5	16.5	20.5	37	28	.247
0119 14 21 39	14	G1/2	27	24	39	16.5	20.5	38	32.5	.262
0119 15 17 39	15	G3/8	22	24	37.5	16.5	20.5	37	28	.246
0119 15 21 39	15	G1/2	27	24	40	16.5	20.5	38	32.5	.251
0119 18 21 39	18	G1/2	27	30	47	20	24.5	43	36	.469
0119 20 27 39	20	G3/4	32	32	50	20.5	24.5	44	39	.638
0119 22 27 39	22	G3/4	32	36	54	22.5	24.5	45	39	.610

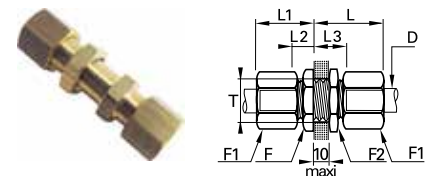

0116 Bulkhead Union

PART NO.	OD	F	F1	F2	L MAX	L1 MAX	L2	L3	OT MIN	KG
0116 04 00	4	10	10	13	27	17	7	17	8.3	.024
0116 05 00	5	13	12	14	28	18	7.5	17.5	10.3	.035
0116 06 00	6	13	13	14	28	19	7.5	17.5	10.3	.037
0116 08 00	8	14	14	17	29	20	7	17	12.3	.045
0116 10 00	10	19	19	22	33	25	9	19	16.5	.101
0116 12 00	12	22	22	22	33	25	9	19	18.5	.121
0116 14 00	14	24	24	24	35	25	8	18	20.5	.145
0116 15 00	15	24	24	24	35	25	8	18	20.5	.134
0116 16 00	16	27	27	27	36	28	9.5	19.5	22.5	.189
0116 18 00	18	27	30	30	40	30	10.5	20.5	24.5	.237
0116 20 00	20	32	30	32	41	31	11	21	27.5	.274
0116 22 00	22	36	36	36	42	32	11	21	30.5	.372
0116 25 00	25	36	41	38	46	36	11	21	33.5	.469

WARNING These products can expose you to chemicals including LEAD which is known to the state of California

[Click here for CADs, Product Specifications or to Configure Parts Online](#)

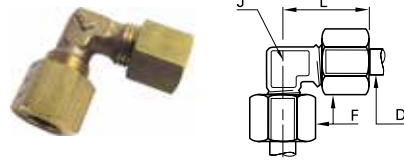

0102 Union Elbow

PART NO.	OD	F	J	L MAX	KG
0102 04 00	4	10	5	19	.016
0102 05 00	5	12	8	21	.024
0102 06 00	6	13	8	22	.027
0102 08 00	8	14	10	28	.038
0102 10 00	10	19	12	30	.073
0102 12 00	12	22	15	30	.098
0102 14 00	14	24	19	35	.133
0102 15 00	15	24	19	35	.122
0102 16 00	16	27	19	39	.164
0102 18 00	18	30	23	41	.231
0102 20 00	20	32	23	42	.233
0102 22 00	22	36	27	50	.371
0102 25 00	25	41	27	54	.446
0102 28 00	28	42	32	54.5	.478

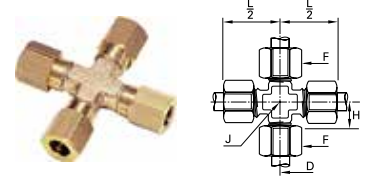

0107 Union Cross

PART NO.	OD	F	H	J	L2	KG
0107 04 00	4	10	9.5	8	19	.035
0107 05 00	5	12	11	8	21	.047
0107 06 00	6	13	11	8	22	.052
0107 08 00	8	14	15	11	28	.073
0107 10 00	10	19	14.5	14	30	.142
0107 12 00	12	22	15	15	35	.096
0107 14 00	14	24	18	20	35	.246
0107 15 00	15	24	18	20	35	.227
0107 16 00	16	27	21	20	39	.312
0107 18 00	18	30	21.5	25	41	.426
0107 20 00	20	32	21.5	25	42	.429
0107 22 00	22	36	29	27	50	.676
0107 25 00	25	41	29	27	50	.819

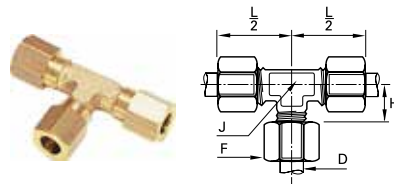

0104 Union Tee

PART NO.	OD	F	H	J	L 2	KG
0104 04 00	4	10	9.5	8	19	.028
0104 05 00	5	12	11	8	21	.036
0104 06 00	6	13	11	8	22	.040
0104 08 00	8	14	15	10	28	.055
0104 10 00	10	19	14.5	12	30	.105
0104 12 00	12	22	15	15	30	.142
0104 14 00	14	24	18	19	35	.190
0104 15 00	15	24	18	19	35	.175
0104 16 00	16	27	21	19	39	.239
0104 18 00	18	30	21.5	23	41	.330
0104 20 00	20	32	21.5	23	42	.330
0104 22 00	22	36	29	27	50	.518
0104 25 00	25	41	29	27	54	.630

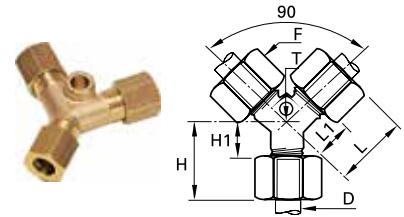

0142 Union Y with Mounting Boss

PART NO.	OD	F	H MAX	H1	L MAX	L1	OT	KG
0142 04 00	4	10	16.5	7	26.5	17	4.2	.032
0142 06 00	6	13	19.5	8.5	28	17	4.2	.049
0142 08 00	8	14	21	8	30	17	6.2	.061
0142 10 00	10	19	24.5	9	37.5	22	6.2	.128
0142 12 00	12	22	26	11	38	23	6.2	.110
0142 14 00	14	24	28	11	41.5	24.5	6.2	.201
0142 15 00	15	24	28	11	41.5	24.5	6.2	.204
0142 16 00	16	27	30	12	43	25	6.2	.252
0142 18 00	18	30	31.5	12	50.5	31	10.2	.220
0142 25 00	25	41	39	14	59	34	10.2	.728

WARNING These products can expose you to chemicals including LEAD which is known to the state of California

[Click here for CADs, Product Specifications or to Configure Parts Online](#)

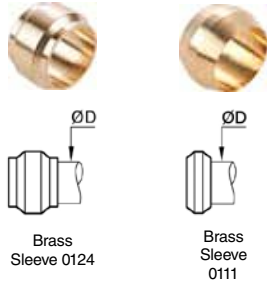

0124 Suffix 40, 0111 Sleeves

OD MM	PART NO.	WT	PART NO.	WT
4	0124 04 40	.001	0111 04 00	.001
5	0124 05 40	.001	0111 05 00	.001
6	0124 06 40	.001	0111 06 00	.001
8	0124 08 40	.002	0111 08 00	.002
10	0124 10 40	.003	0111 10 00	.002
12	0124 12 40	.004	0111 12 00	.003
14	0124 14 40	.004	0111 14 00	.003
15	0124 15 40	.004	0111 15 00	.003
16	0124 16 40	.006	0111 16 00	.004
18	0124 18 40	.007	-	-
20	0124 20 40	.009	-	-
22	0124 22 40	.012	-	-
25	0124 25 40	.017	-	-
28	0124 28 40	.017	-	-

Technical Specifications of Nuts

Tightening Torque

- Maximum kg = tightening torque for nut 0110 and sleeve 0124 on copper, brass or steel tube

OD MM	MAX KG. TORQUE
4	.7
5	.7
6	1.5
8	1.5
10	1.8
12	3
14	3.5
15	4
16	5
18	6
20	6
22	7
25	8
28	9

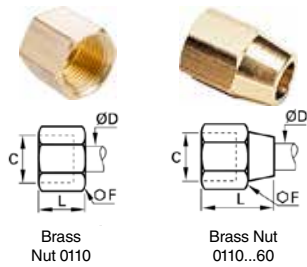

0110, 0110 Suffix 60 Nuts

OD MM	C	PART NO.	WT	PART NO.	WT
4	M8X1	0110 04 00	.005	0110 04 00 60	.006
5	M10X1	0110 05 00	.006	0110 05 00 60	.009
6	M10X1	0110 06 00	.008	0110 06 00 60	.011
8	M12X1	0110 08 00	.008	0110 08 00 60	.012
10	M16X1.5	0110 10 00	.019	0110 10 00 60	.027
12	M18X1.5	0110 12 00	.026	0110 12 00 60	.041
14	M20X1.5	0110 14 00	.029	-	-
15	M20X1.5	0110 15 00	.028	0110 15 00 60	.050
16	M22X1.5	0110 16 00	.043	0110 16 00 60	.072
18	M24X1.5	0110 18 00	.059	-	-
20	M27X1.5	0110 20 00	.057	-	-
22	M30X1.5	0110 22 00	.079	-	-
25	M33X1.5	0110 25 00	.121	-	-
28	M36X1.5	0110 28 00	.109	-	-

⚠ WARNING These products can expose you to chemicals including LEAD which is known to the state of California

Complementary Brass Fittings – Assembly Configuration

The table and information given below illustrate the large number of options available with Parker Legris brass compression fittings. To these must be added the advantages specific to the original Parker Legris reducer shown on the previous page.



	0124 BRASS	0111 BNA** BRAS	0124 BRASS	0111 BNA** BRAS	01 24...40 STEEL	
No olive required to assemble the plug						No olive required to assemble the tube
Brass plug: 0126	Copper, cold-rolled brass, polymer tube and barb connectors 0122 and 0165	Coiled annealed copper tube	Cold-rolled copper tube for vibration and side loading, etc.	Coiled annealed copper tube for vibration and side loading, etc.	Steel or copper tube: low/medium hydraulic pressure, lubricate before assembly	Polymer tube

*Assembly specifications for nut-olive 0110 ..70

This part functions as both olive and nut for flexible polymer tube assemblies:

1. Hand tighten the polymer nut-olive a few turns onto the body of the fitting; the knurling makes this easier.
2. Then introduce the polymer tube and push home into the body of the fitting.
3. Continue manually tightening the polymer nut-olive.
4. Finish tightening using a spanner until the nut body disengages and turns freely, which acts as a torque limiter.

N.B.: To avoid damaging the threads, do not insert the tube before hand tightening the nut-olive into the body of the fitting.

**Bureau de Normalisation de l'Automobile (French Automotive Bureau of Standards)

Recommended Tightening Torque

Tightening torque in daN.m = maximum tightening torque of a 0110 nut and 0124 olive with copper, brass or steel tube.

Nut 0110 and 0110..40

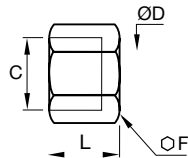

Nut 0110..60

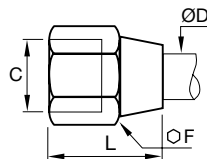

Ø D (MM)	F 0110	F 0110..60	MAX. DAN.M COPPER OR BRASS	F 0110..40	MAX. DAN.M STEEL
4	10	11	.7	10	1.5
5	12	12	.7	12	1.5
6	13	12	1.5	13	2.5
8	14	16	1.5	14	2.5
10	19	20	1.8	19	3
12	22	22	3	22	4.5
14	24	24	3.5	24	5.5
15	24	24	4	24	6
16	27	27	5	27	7
18	30	30	6	30	9
20	32	32	6	32	10
22	36	36	7	36	12
25	41	42	8	41	13
28	42		9		

WARNING These products can expose you to chemicals including LEAD which is known to the state of California

[Click here for CADs, Product Specifications or to Configure Parts Online](#)

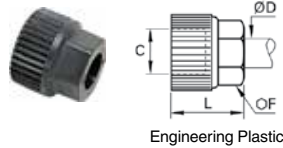

Engineering Plastic

0110 Suffix 70 Nut Sleeve

PART NO.	OD MM	C	F MM	L MM	WT
0110 04 00 70	4	M8X1	8	13	.001
0110 06 00 70	6	M10X1	11	15	.002
0110 08 00 70	8	M12X1	13	16	.002
0110 10 00 70	10	M16X1.5	17	19	.004
0110 12 00 70	12	M18X1.5	19	19	.005
0110 14 00 70	14	M20X1.5	22	20	.007
0110 16 00 70	16	M22X1.5	24	21	.009

Plastic nut-sleeve should not be used on metal tubes.

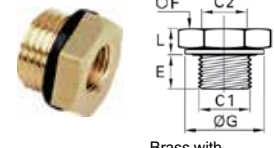

Brass with Bi-Material Seal

0168 Reducer Male To Female BSPP

PART NO.	C1 BSPP	C2 BSPP	E MM	F MM	G MM	L MM	WT
0168 10 19 39	G 1/8	M5X.8	8	14	14	4.5	.010
0168 13 19 39	G 1/4	M5X.8	8	17	17	5	.012
0168 13 10 39	G 1/4	G 1/8	8	17	17	5	.020
0168 17 10 39	G 3/8	G 1/8	10	19	22	5	.028
0168 17 13 39	G 3/8	G 1/4	10	19	22	5	.035
0168 21 10 39	G 1/2	G 1/8	12	24	26	7.5	.039
0168 21 13 39	G 1/2	G 1/4	12	24	26	7.5	.056
0168 21 17 39	G 1/2	G 3/8	12	24	26	7.5	.062
0168 27 13 39	G 3/4	G 1/4	12	32	32	9.5	.067
0168 27 17 39	G 3/4	G 3/8	12	32	32	9.5	.097
0168 27 21 39	G 3/4	G 1/2	12	32	32	9.5	.116

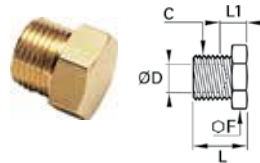

0125 End Plug Metric

PART NO.	OD MM	C	F MM	L MM	L1 MM	WT
0125 06 00	6	M10X1	11	13.5	9.5	.009
0125 08 00	8	M12X1	14	14	9	.012
0125 10 00	10	M16X1.5	17	18	11	.025

The plug enables unused tubes to be blanked off. The male thread on the plug has the same pitch as the female thread on the nut of a standard Legris fitting. Therefore, the plug screwed into the nut blanks off the tube.

To reopen the passage, simply unscrew the plug and fit the required connector. No further treatment of the tube is required.

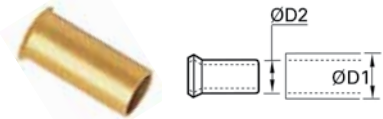

0127 Tube Support for Plastic Tube

PART NO.	ØD1 MM	ØD2 MM	WT
0127 04 00	4	2	.001
0127 04 27	4	2.7	.001
0127 05 03	5	3	.001
0127 05 00	5	3.3	.001
0127 06 00	6	4	.001
0127 08 55	8	5.5	.001
0127 08 00	8	6	.001
0127 10 07	10	7	.002
0127 10 75	10	7.5	.002
0127 10 00	10	8	.002
0127 12 08	12	8	.002
0127 12 09	12	9	.002
0127 12 00	12	10	.002
0127 14 11	14	11	.003
0127 14 00	14	12	.003
0127 15 12	15	12	.003
0127 16 13	16	13	.003
0127 18 14	18	14	.004
0127 20 15	20	15	.004
0127 22 16	22	16	.005
0127 25 19	25	19	.005

At high temperature and pressure or during oscillating movements, the use of tube supports prevents distortion of the tube and guarantees effective gripping and sealing.

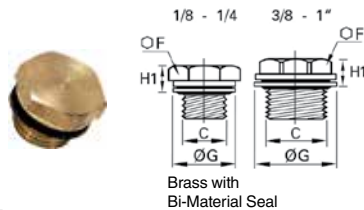

Brass with Bi-Material Seal

0220 Male Plug BSPP

PART NO.	C BSPP	F MM	G MM	H1 MM	WT
0220 10 00 39	G 1/8	14	14	6.5	.005
0220 13 00 39	G 1/4	17	17	6.5	.016
0220 17 00 39	G 3/8	17	22	8	.021
0220 21 00 39	G 1/2	22	26	9	.045
0220 27 00 39	G 3/4	22	32	10	.053
0220 34 00 39	G 1	27	39.5	10.5	.067

WARNING These products can expose you to chemicals including LEAD which is known to the state of California



Poly-Tite Fittings

Parker's Poly-Tite Fittings are compact, pre-assembled compression style fittings designed for fast assembly. An exclusive acetal copolymer sleeve has superior resilience to resist creeping and stress caused from compression.

Product Features:

- Self aligning captive sleeve
- Built-in tube support
- Knurled nuts for hand tightening
- Plastic and brass sleeves available
- Chrome plated and stainless steel side latch couplers available

Markets:

- Dental
- Packaging
- Machine Tools
- Car Wash
- Printing

Applications:

- Pneumatic Systems
- Water Lines
- Dental Equipment

Specifications:

Pressure Range Up to 150 PSI (10.3 bar)

Temperature Range 0° to +150° F (-17.7° to +65.5° C)

O-rings

Buna N on chrome plated couplers
 Fluorocarbon on Stainless
 Steel couplers

Compatible Tubing:

- Polyethylene
- Nylon
- Polypropylene
- Vinyl

Assembly Instructions

Polyethylene, polypropylene and vinyl tubing:

1. Cut tubing squarely—maximum of 15° angle allowable.
2. Check that port or mating part is clean and free of debris.
3. Insert tube end until it bottoms in the Poly-Tite fitting and tighten knurl/hex nut finger-tight — plus one wrench turn.

Tube Support O.D.

TUBE SIZE INCHES	* D1 TUBE SUPPORT O.D.
1/4	.168
5/16	.185
3/8	.248
1/2	.373

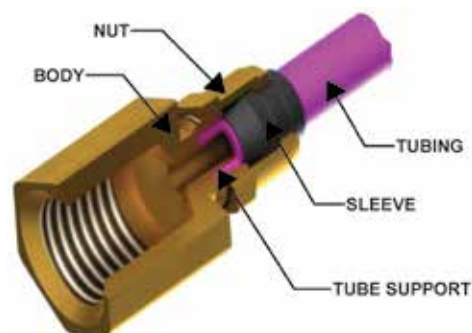
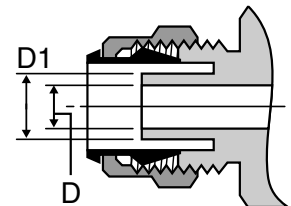

[Click here for CADs, Product Specifications or to Configure Parts Online](#)

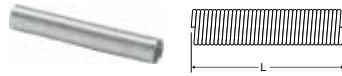

Spring Guard 56PSG

PART NO.	TUBE O. D.	L
56PSG-4	1/4	3.000
56PSG-5	5/16	3.000
56PSG-6	3/8	3.000

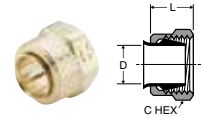

Nut and Brass Sleeve Assembly 61PB

PART NO.	TUBE SIZE	STRAIGHT THREAD	C HEX	D	L
61PB-4	1/4	3/8-24	7/16	.255	.38
61PB-5	5/16	7/16-24	1/2	.318	.34
61PB-6	3/8	1/2-24	9/16	.382	.38
61PB-8	1/2	11/16-20	3/4	.507	.44



Plastic Cap 59P

PART NO.	TUBE SIZE	A	L
59P-4	1/4	.247	.50
59P-6	3/8	.372	.56
59P-8	1/2	.497	.63

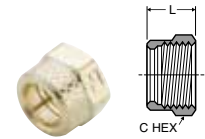

Nut 61PN

PART NO.	TUBE SIZE	STRAIGHT THREAD	C HEX	L
61PN-4	1/4	3/8-24	7/16	.38
61PN-5	5/16	7/16-24	1/2	.34
61PN-6	3/8	1/2-24	9/16	.38
61PN-8	1/2	11/16-20	3/4	.44

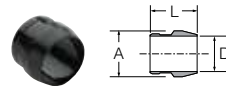

Acetal Plastic Sleeve 60P

PART NO.	TUBE SIZE	A	D	L
60P-4	1/4	.334	.261	.338
60P-5	5/16	.405	.321	.340
60P-6	3/8	.465	.381	.367
60P-8	1/2	.628	.514	.399

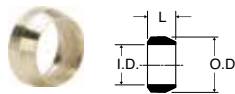

Sleeve 60PB

PART NO.	L	O. D.	I. D.
60PB-4	.187	.336	.255
60PB-5	.187	.400	.318
60PB-6	.218	.460	.382
60PB-8	.250	.620	.507



Nut only for use with Spring Gaurd 61PSGN

PART NO.	TUBE O. D.	L	C HEX
61PSGN-4	1/4	.625	.437
61PSGN-6	3/8	.656	.562



Nut and Plastic Sleeve Assembly 61P

PART NO.	TUBE SIZE	STRAIGHT THREAD	C HEX	D	L
61P-4	1/4	3/8-24	7/16	.261	.38
61P-5	5/16	7/16-24	1/2	.321	.34
61P-6	3/8	1/2-24	9/16	.380	.38
61P-8	1/2	11/16-20	3/4	.514	.44

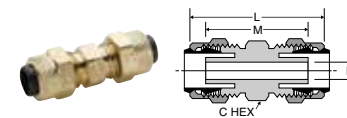

Union 62P

PART NO.	TUBE SIZE	STRAIGHT THREAD	C HEX	L	M	FLOW DIA. D
62P-4	1/4	3/8-24	3/8	1.17	.96	.125
62P-5	5/16	7/16-24	7/16	1.16	.96	.144
62P-6	3/8	1/2-24	1/2	1.23	.99	.204
62P-8	1/2	11/16-20	11/16	1.47	1.24	.323

WARNING: These products can expose you to chemicals including NICKEL, CARBON BLACK, TITANIUM DIOXIDE, or LEAD, which are known to the state of

[Click here for CADs, Product Specifications or to Configure Parts Online](#)

Union Reducer 62P

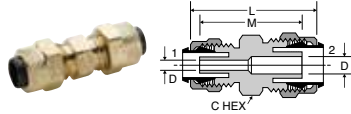

PART NO.	1 TUBE SIZE	2 TUBE SIZE	1 STRAIGHT THREAD	2 STRAIGHT THREAD	C HEX	L	M	FLOW DIA. D
62P-6-4	1/4	3/8	3/8-24	1/2-24	1/2	1.22	.99	.125

Bulkhead Union 62PTBH

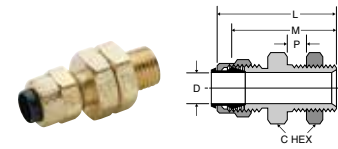

(Straight Through)

PART NO.	TUBE SIZE	STRAIGHT THREAD	C HEX	P MAX.	L	M	BULKHEAD HOLE DIA.	FLOW DIA. D
62PTBH-4	1/4	3/8-24	9/16	.31	1.19	.93	3/8	.260
62PTBH-5	5/16	7/16-24	5/8	.31	1.19	.93	7/16	.323
62PTBH-6	3/8	1/2-24	11/16	.34	1.26	.99	1/2	.387

Bulkhead Union 62PBH

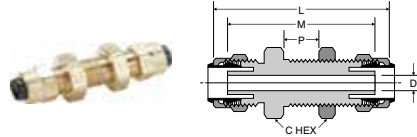

PART NO.	TUBE SIZE	STRAIGHT THREAD	C HEX	P MAX.	L	M	BULKHEAD HOLE DIA.	FLOW DIA. D
62PBH-4	1/4	3/8-24	9/16	.38	1.75	1.53	3/8	.125
62PBH-5	5/16	7/16-24	5/8	.38	1.71	1.52	7/16	.144
62PBH-6	3/8	1/2-24	11/16	.47	1.89	1.65	1/2	.204
62PBH-8	1/2	11/16-20	7/8	.63	2.28	2.05	11/16	.323

Female Connector 66P

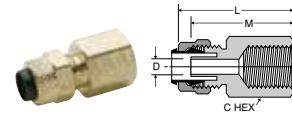

PART NO.	TUBE SIZE	PIPE THREAD	STRAIGHT THREAD	C HEX	L	M	FLOW DIA. D
66P-4-2	1/4	1/8	3/8-24	9/16	.97	.86	.125
66P-4-4	1/4	1/4	3/8-24	5/8	1.18	1.07	.125
66P-5-2	5/16	1/8	7/16-24	9/16	.97	.86	.144
66P-6-4	3/8	1/4	1/2-24	5/8	1.18	1.07	.204
66P-8-6	1/2	3/8	11/16-20	13/16	1.31	1.20	.323

Union 62PCA

(Tube to Compress-Align)

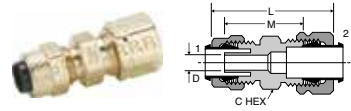

PART NO.	TUBE SIZE	1 STRAIGHT THREAD	2 STRAIGHT THREAD	C HEX	L	M	FLOW DIA. D
62PCA-4	1/4	3/8-24	7/16-24	7/16	1.25	.89	.125
62PCA-5	5/16	7/16-24	1/2-24	1/2	1.30	.92	.144
62PCA-6	3/8	1/2-24	9/16-24	9/16	1.37	.98	.204

Bulkhead Union 62PCABH

(Tube to Compress-Align)

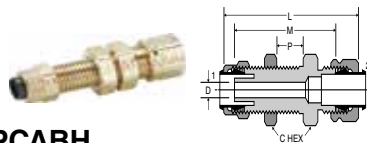

PART NO.	TUBE SIZE	1 STR THD	2 STR THD	C HEX	P MAX	L	M	BLKHD HOLE DIA.	FLOW DIA. D
62PCABH-4	1/4	3/8-24	7/16-24	9/16	.38	1.81	1.45	3/8	.125
62PCABH-6	3/8	1/2-24	9/16-24	11/16	.47	2.03	1.64	1/2	.204

WARNING These products can expose you to chemicals including NICKEL, CARBON BLACK, TITANIUM DIOXIDE, or LEAD, which are known to the state of

[Click here for CADs, Product Specifications or to Configure Parts Online](#)

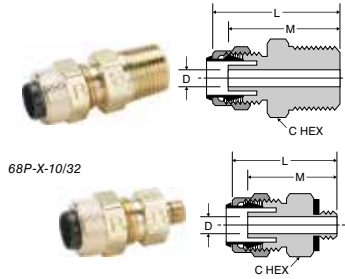

Male Connector 68P

PART NO.	TUBE SIZE	PIPE THREAD	STRAIGHT THREAD	C HEX	L	M	FLOW DIA. D
68P-4-1	1/4	1/16	3/8-24	3/8	1.06	.95	.125
68P-4-10X32	1/4	10-32	3/8-24	3/8	.86	.75	.094
68P-4-2	1/4	1/8	3/8-24	7/16	1.06	.95	.125
68P-4-4	1/4	1/4	3/8-24	9/16	1.25	1.14	.125
68P-4-6	1/4	3/8	3/8-24	11/16	1.28	1.17	.125
68P-5-2	5/16	1/8	7/16-24	7/16	1.05	.95	.144
68P-5-4	5/16	1/4	7/16-24	9/16	1.24	1.14	.144
68P-6-2	3/8	1/8	1/2-24	1/2	1.10	.98	.204
68P-6-4	3/8	1/4	1/2-24	9/16	1.29	1.17	.204
68P-6-6	3/8	3/8	1/2-24	11/16	1.29	1.17	.204
68P-8-4	1/2	1/4	11/16-20	11/16	1.46	1.29	.320
68P-8-6	1/2	3/8	11/16-20	11/16	1.37	1.29	.323

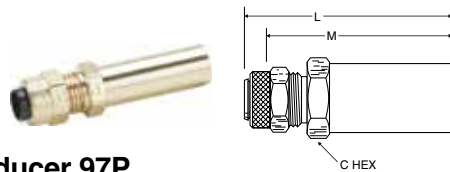

Tube End Reducer 97P

PART NO.	TUBE O.D.	L	M	C HEX
97P-4-6	3/8 X 1/4	1.718	1.625	.437
97P-6-8	1/2 X 3/8	1.875	1.781	.562

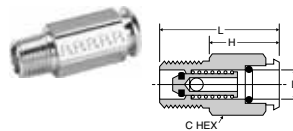

Pipe Coupler Body 391P

(Chrome Plated)

PART NO.	D-INSERT DIA.	PIPE THREAD	C HEX	H	L
391P-4-2	1/4	1/8	1/2	.91	1.29
391P-4-4	1/4	1/4	9/16	.73	1.29
391P-6-4	3/8	1/4	11/16	.85	1.41

Pipe Coupler Body 391PSS

(Stainless Steel)

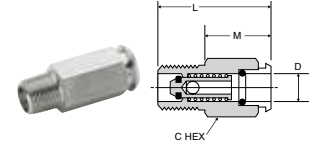

PART NO.	D INSERT DIA.	PIPE THREAD	L	C HEX	M
391PSS-4-2	1/4	1/8	1.271	.500	.900
391PSS-4-4	1/4	1/4	1.271	.562	.710
391PSS-6-4	3/8	1/4	1.40	.625	.840

Bulkhead Coupler Body 392P

(Chrome Plated)

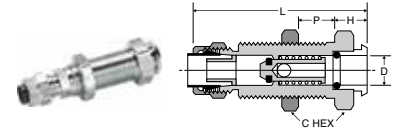

PART NO.	TUBE SIZE	D-INSERT DIA.	STRAIGHT THREAD	C HEX	P MAX.	H	L	BULKHEAD HOLE DIA.
392P-4-4	1/4	1/4	1/2-24	5/8	.84	.39	2.13	1/2
392P-6-6	3/8	3/8	11/16-24	13/16	.93	.37	2.01	11/16

Bulkhead Coupler Body 392PSS

(Stainless Steel)

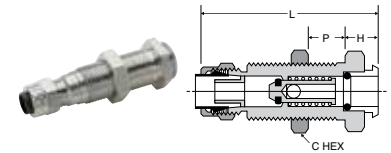

PART NO.	TUBE O.D.	BULKHEAD THREAD	L	C HEX	H	P MAX	BULKHEAD HOLE DIA.
392PSS-4-4	1/4	1/2-24	2.03	.625	.28	.84	1/2
392PSS-6-6	3/8	11/16-24	2.20	.812	.31	.93	11/16

Through Type Insert 393P

(Chrome Plated)

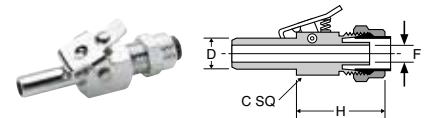

PART NO.	TUBE SIZE	D-INSERT DIA.	STRAIGHT THREAD	C SQUARE	H	FLOW DIA. F
393P-4-4	1/4	1/4	3/8-24	7/16	1.12	.125
393P-6-6	3/8	3/8	1/2-24	1/2	1.34	.203

Through Type Insert 393PSS

(Stainless Steel)

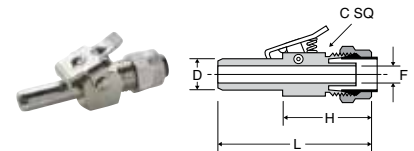

PART NO.	TUBE O.D.	D-INSERT DIA.	L	C SQUARE	H	FLOW DIA. F
393PSS-4-4	1/4	1/4	1.677	7/16	.99	.125
393PSS-6-6	3/8	3/8	2.030	1/2	1.27	.203

WARNING These products can expose you to chemicals including NICKEL, CARBON BLACK, TITANIUM DIOXIDE, or LEAD, which are known to the state of

Shutoff Type Insert 393PD

(Chrome Plated)

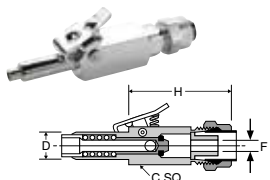

PART NO.	TUBE SIZE	D-INSERT DIA.	STRAIGHT THREAD	C SQUARE	H	FLOW DIA. F
393PD-4-4	1/4	1/4	3/8-24	7/16	1.61	.110
393PD-6-6	3/8	3/8	1/2-24	1/2	1.45	.187

Shut-Off Type Insert 393PDSS

(Stainless Steel)

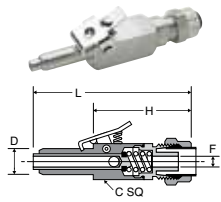

PART NO.	TUBE O.D.	D-INSERT DIA.	L	C SQUARE	H	FLOW DIA. F
393PDSS-4-4	1/4	1/4	2.46	.500	1.62	.116
393PDSS-6-6	3/8	3/8	2.60	.500	1.67	.157

Single End Shutoff Bulkhead Quick Coupler 394P

(Chrome Plated)

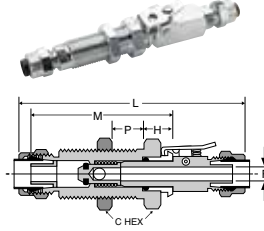

PART NO.	TUBE SIZE	STRAIGHT THREAD	C HEX	P MAX	H	L	M	BULKHEAD HOLE DIA.	FLOW DIA. F
394P-4-4	1/4	1/2-24	5/8	.84	.39	3.28	2.13	1/2	.125
394P-6-6	3/8	11/16-24	13/16	.93	.37	3.41	2.01	11/16	.203

Coupler Single End Shut-Off Bulkhead 394PSS

(Stainless Steel)

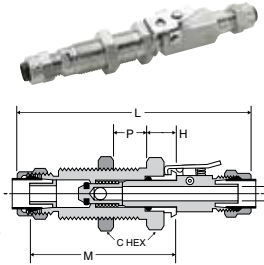

PART NO.	TUBE O.D.	BULKHEAD THREAD	L	M	C HEX	H	P MAX	FLOW DIA. F
394PSS-4-4	1/4	1/2-24	3.05	2.06	.625	.31	.84	.125
394PSS-6-6	3/8	11/16-24	3.50	2.23	.812	.34	.93	.203

Double End Shutoff Bulkhead Quick Coupler 394PD

(Chrome Plated)

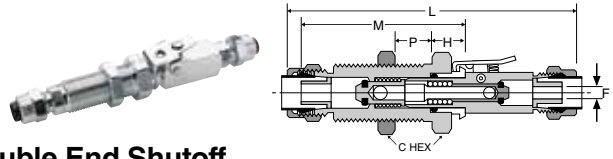

PART NO.	TUBE SIZE	STRAIGHT THREAD	C HEX	P MAX	H	L	M	BULKHEAD HOLE DIA.	FLOW DIA. F
394PD-4-4	1/4	1/2-24	5/8	.84	.39	3.77	2.13	1/2	.125
394PD-6-6	3/8	11/16-24	13/16	.93	.37	3.48	2.01	11/16	.204

Double End Shut-Off Bulkhead Quick Coupler 394PDSS

(Stainless Steel)

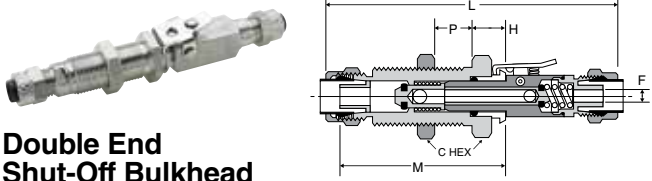

PART NO.	TUBE O.D.	BULKHEAD THREAD	L	M	C HEX	H	P MAX	FLOW DIA. F
394PDSS-4-4	1/4	1/2-24	3.69	2.67	.625	.32	.84	.125
394PDSS-6-6	3/8	11/16-24	3.91	2.24	.812	.34	.93	.203

Single End Shutoff Pipe Connector Quick Coupler 398P

(Chrome Plated)

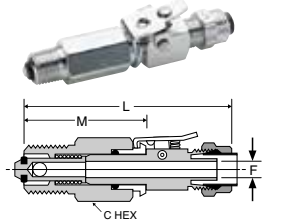

PART NO.	TUBE SIZE	PIPE THREAD	STRAIGHT THREAD	C HEX	L	M	FLOW DIA. F
398P-4-2	1/4	1/8	3/8-24	1/2	2.45	1.32	.125
398P-4-4	1/4	1/4	3/8-24	9/16	2.45	1.32	.125
398P-6-4	3/8	1/4	1/2-24	5/8	2.80	1.46	.203

Single End Shut-Off Connector Quick Coupler 398PSS

(Stainless Steel)

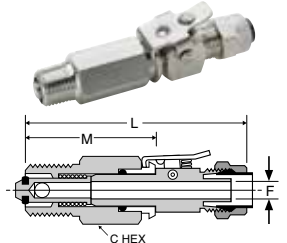

PART NO.	TUBE O.D.	PIPE THREAD	L	M	C HEX	FLOW DIA. F
398PSS-4-2	1/4	1/8	2.30	1.32	.500	.125
398PSS-4-4	1/4	1/4	2.30	1.32	.562	.125
398PSS-6-4	3/8	1/4	2.70	1.43	.625	.203

WARNING: These products can expose you to chemicals including NICKEL, CARBON BLACK, TITANIUM DIOXIDE, or LEAD, which are known to the state of

[Click here for CADs, Product Specifications or to Configure Parts Online](#)

Double End Shutoff Pipe Connector Quick Coupler 398PD

(Chrome Plated)

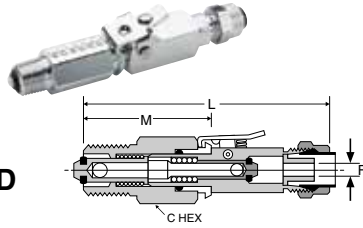

PART NO.	TUBE SIZE	PIPE THREAD	STRAIGHT THREAD	C HEX	L	M	FLOW DIA. F
398PD-4-2	1/4	1/8	3/8-24	1/2	2.93	1.31	.125
398PD-4-4	1/4	1/4	3/8-24	9/16	2.93	1.32	.125
398PD-6-4	3/8	1/4	1/2-24	5/8	2.88	1.43	.204

Double End Shut-Off Pipe Connector Quick Coupler 398PDSS

(Stainless Steel)

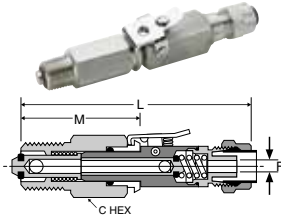

PART NO.	TUBE O. D.	PIPE THREAD	L	M	C HEX	FLOW DIA. D
398PDSS-4-2	1/4	1/8	2.93	1.31	.500	.125
398PDSS-4-4	1/4	1/4	2.93	1.31	.562	.125
398PDSS-6-4	3/8	1/4	3.10	1.43	.625	.125

Male Elbow 169P

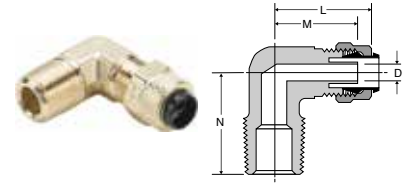

PART NO.	TUBE SIZE	PIPE THREAD	STRAIGHT THREAD	L	M	N	FLOW DIA. D
169P-4-1	1/4	1/16	3/8-24	.92	.58	.67	.130
169P-4-2	1/4	1/8	3/8-24	.84	.73	.75	.121
169P-4-4	1/4	1/4	3/8-24	.90	.79	.92	.125
169P-4-6	1/4	3/8	3/8-24	.93	.84	1.08	.125
169P-5-2	5/16	1/8	7/16-24	.87	.73	.68	.144
169P-6-2	3/8	1/8	1/2-24	.93	.81	.73	.203
169P-6-4	3/8	1/4	1/2-24	.98	.86	1.05	.203
169P-6-6	3/8	3/8	1/2-24	.98	.86	1.08	.203
169P-8-6	1/2	3/8	11/16-20	1.12	1.04	1.13	.323

Long Male Elbow 169LP

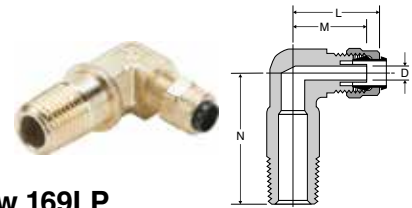

PART NO.	TUBE SIZE	PIPE THREAD	STRAIGHT THREAD	L	M	N	FLOW DIA. D
169LP-4-4	1/4	1/4	3/8-24	.90	.79	1.38	.125

Union Tee 164P

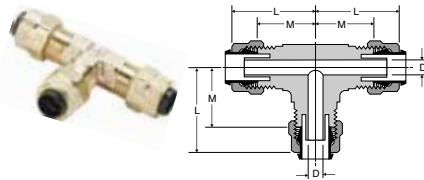

PART NO.	TUBE SIZE	STRAIGHT THREAD	L	M	FLOW DIA. D
164P-4	1/4	3/8-24	.84	.73	.125
164P-5	5/16	7/16-24	.83	.73	.144
164P-6	3/8	1/2-24	.98	.86	.203
164P-8	1/2	11/16-20	1.12	1.04	.323

Union Tee 164P combination size

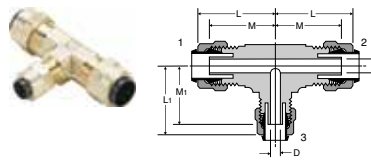

PART NO.	1 TUBE SIZE	2 TUBE SIZE	3 TUBE SIZE	L	L1	M	M1	FLOW DIA. D
164P-6-4	3/8	3/8	1/4	.98	.90	.86	.79	.125

Male Elbow Swivel 169PS

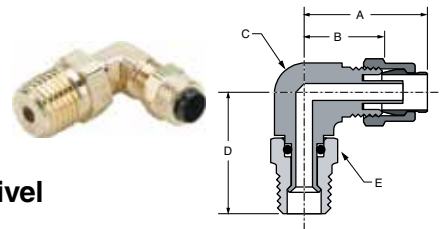

PART NO.	TUBE O. D.	PIPE THREAD	A	B	C HEX	D	E
169PS-4-2	1/4	1/8	.812	.594	.375	.862	.437
169PS-4-4	1/4	1/4	.906	.688	.562	1.218	.562
169PS-6-2	3/8	1/8	.875	.625	.437	.904	.437
169PS-6-4	3/8	1/4	.937	.685	.562	1.218	.562
169PS-6-6	3/8	3/8	.859	.602	.562	1.190	.687
169PS-8-6	1/2	3/8	1.031	.782	.500	1.218	.687

WARNING: These products can expose you to chemicals including NICKEL, CARBON BLACK, TITANIUM DIOXIDE, or LEAD, which are known to the state of California to cause cancer or reproductive harm. For more information go to www.cdph.ca.gov.

[Click here for CADs, Product Specifications or to Configure Parts Online](#)

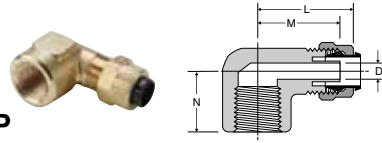

Female Elbow 170P

PART NO.	TUBE SIZE	PIPE THREAD	STRAIGHT THREAD	L	M	N	FLOW DIA. D
170P-4-2	1/4	1/8	3/8-24	.90	.79	.56	.125
170P-4-4	1/4	1/4	3/8-24	1.00	.89	.69	.125
170P-6-4	3/8	1/4	1/2-24	1.01	.89	.69	.204
170P-8-6	1/2	3/8	11/16-20	1.19	1.11	1.13	.323

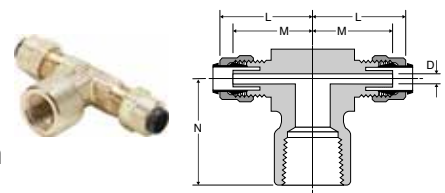

Female Branch Tee 177P

PART NO.	TUBE SIZE	PIPE THREAD	STRAIGHT THREAD	L	M	N	FLOW DIA. D
177P-4-2	1/4	1/8	3/8-24	.92	.81	.88	.125
177P-4-4	1/4	1/4	3/8-24	.92	.81	1.03	.125
177P-4-6	1/4	3/8	3/8-24	1.03	.92	1.13	.125

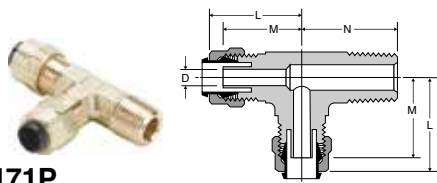

Male Run Tee 171P

PART NO.	TUBE SIZE	PIPE THREAD	STRAIGHT THREAD	L	M	N	FLOW DIA. D
171P-4-2	1/4	1/8	3/8-24	.84	.73	.72	.125
171P-4-4	1/4	1/4	3/8-24	.92	.81	.92	.125
171P-5-2	5/16	1/8	7/16-24	.83	.73	.72	.144
171P-6-4	3/8	1/4	1/2-24	.98	.86	1.03	.203
171P-8-6	1/2	3/8	11/16-20	1.12	1.04	1.13	.323

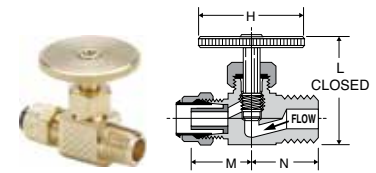

Needle Valve NV311P

PART NO.	TUBE SIZE	PIPE THREAD	H	L OPEN	L CLOSED	M	N
NV311P-4-2	1/4	1/8	1.06	1.36	1.16	.64	.63
NV311P-4-4	1/4	1/4	1.06	1.38	1.18	.64	.72
NV311P-6-4	3/8	1/4	1.06	1.38	1.18	.64	.72

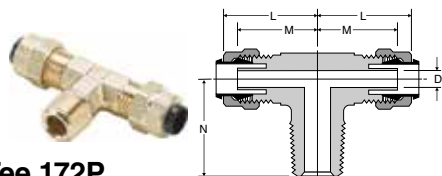

Male Branch Tee 172P

PART NO.	TUBE SIZE	PIPE THREAD	STRAIGHT THREAD	L	M	N	FLOW DIA. D
172P-4-2	1/4	1/8	3/8-24	.84	.73	.72	.125
172P-4-4	1/4	1/4	3/8-24	.92	.81	.92	.125
172P-5-2	5/16	1/8	7/16-24	.83	.73	.72	.144
172P-6-2	3/8	1/8	1/2-24	.88	.86	.74	.204
172P-6-4	3/8	1/4	1/2-24	.98	.86	1.03	.204
172P-8-6	1/2	3/8	11/16-20	1.12	1.04	1.13	.323

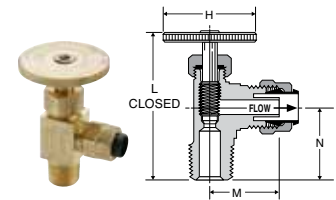

Angle Needle Valve NV312P

PART NO.	TUBE SIZE	PIPE THREAD	H	L OPEN	L CLOSED	M	N
NV312P-4-2	1/4	1/8	1.06	1.70	1.50	.63	.68
NV312P-4-4	1/4	1/4	1.06	2.07	1.82	.71	.86
NV312P-6-4	3/8	1/4	1.06	2.00	1.75	.74	.86

WARNING These products can expose you to chemicals including NICKEL, CARBON BLACK, TITANIUM DIOXIDE, or LEAD, which are known to the state of



Industrial Barbed Fittings

Dubl-Barb[®] Fittings

Hose Barb Fittings



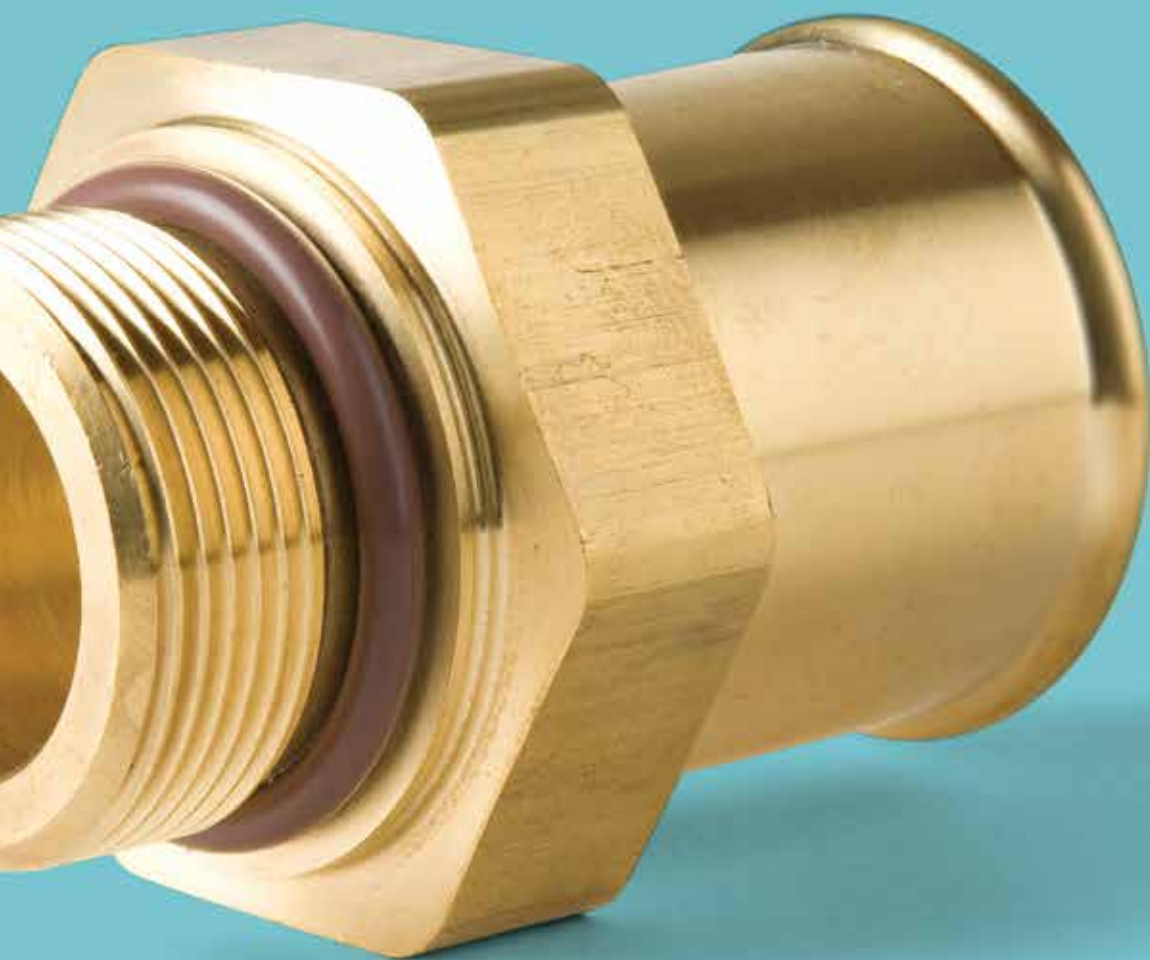

GOODYEAR
RUBBER PRODUCTS, INC.

☎ 727-342-5088

You can also email us at
GRP@goodyearrubberproducts.com

Dubl-Barb® Fittings

20
Plug
p. E6



22
Union
p. E6



22BH
Bulkhead Union
p. E6



22CA
Mixed Union
p. E6



22CABH
Bulkhead Union
p. E6



26
Female Connector
p. E6



27
Male Connector
p. E6



28
Male Connector
p. E6, E7



220
Adapter Tee
p. E7



224
Union Tee
p. E7



225
Union Elbow
p. E7



228
Gauge Tee
p. E7



229
Male Elbow
p. E7



230
Female Elbow
p. E8



231
Run Tee
p. E8



232
Branch Tee
p. E8



237
Female Tee
p. E8



238
Solder Connector
p. E8



Hose Barb Fittings

68HB
Male Connector
p. E10



685HB
Male Connector
p. E10



68HB-X-MIX
Male Connector
p. E10



97HC
Clamp
p. E10



122HBL
Union
p. E10



125HB
Male Connector
p. E10



125HBL
Male Connector
p. E10



125HBLSV
Swivel Connector
p. E11



126HBL
Female Connector
p. E11



127HB
Ball-End Adapter
p. E11



128HBLSV
Female Ball-End
p. E11



129HB
Male Elbow
p. E11



1295HB
Male Elbow
p. E11



139HB
45° Male Elbow
p. E12



146HBLFSV
45° Female Flare
p. E12



1695HB
Male Elbow
p. E12



169HB-X-MIX
Male Elbow
p. E12



1725HB
Tee
p. E12



171HB
Run Tee
p. E12



179HB
45° Male Elbow
p. E12



1795HB
45° Male Elbow
p. E12



179HB-X-MIX
45° Male Elbow
p. E13



269HB
Male Elbow
p. E13



279HB
45° Male Elbow
p. E13



0123
Male Connector
p. E13



0136
Metric Hose to BSPT
p. E14



0191
Metric Hose to BSPP
p. E14



0931
Metric Hose to BSPP
p. E14



WARNING These products can expose you to chemicals including NICKEL or LEAD, which are known to the state of California to cause cancer.

Dubl-Barb® Fittings



Parker's Dubl-Barb Fittings are an economical one piece, push-on brass barbed fitting that does not require any type of clamp. These fittings are a quick way to connect polyethylene tubing.

Product Features:

- Compact
- One piece
- No clamp required
- Good vibration resistance

Markets:

- Pneumatic
- Environmental control

Applications:

- Pneumatic Systems
- Climate Control
- Humidifiers
- Filters

Compatible Tubing:

- Polyethylene



Specifications:

Pressure Range:

TUBE SIZE	PSI	bar	TUBE SIZE	PSI	bar
5/32	150	10.3	3/8	150	10.3
1/4	150	10.3	1/2	100	6.8

Temperature Range:

TUBE SIZE	TEMPERATURE IN FAHRENHEIT	TEMPERATURE IN CELSIUS
5/32	-65° to +90° F	-53.8° to +32.2° C
1/4	-65° to +90° F	-53.8° to +32.2° C
3/8	-65° to +90° F	-53.8° to +32.2° C
1/2	-65° to +75° F	-53.8° to +23.8° C

Assembly Instructions

Cut tube squarely and simply push tube over the two barbs



Plug 20

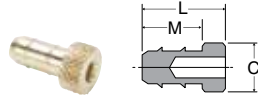

PART NO.	TUBE O.D.	TUBE I.D.	C DIA.	L	M
20-4	1/4	.170	.32	.56	.41
20-6	3/8	.250	.390	.68	.44
20-8	1/2	.377	.577	.81	.56

Plug Adapter 20

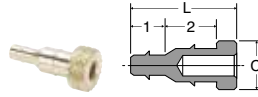

PART NO.	TUBE O.D. 1	TUBE I.D. 1	TUBE O.D. 2	TUBE I.D. 2	C DIA.	L
20-4-5/32	5/32	.096	1/4	.170	.32	.65

Union 22

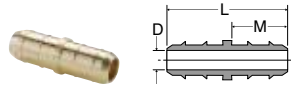

PART NO.	TUBE O.D.	TUBE I.D.	L	M	FLOW DIA. D
22-5/32	5/32X5/32	.096X.096	.59	.28	.062
22-4	1/4X1/4	.170X.170	.84	.41	.120
22-6	3/8X3/8	.250X.250	.94	.44	.187
22-8	1/2X1/2	.375X.375	1.19	.56	.312

Union Reducer 22

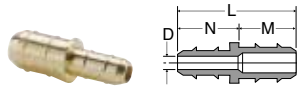

PART NO.	TUBE O.D.	TUBE I.D.	L	M	N	FLOW DIA. D
22-4-5/32	1/4X5/32	.170X.096	.72	.41	.28	.062
22-4-6	1/4X3/8	.170X.250	.88	.44	.41	.120
22-4-8	1/4X1/2	.170X.375	1.06	.56	.41	.120
22-6-8	3/8X1/2	.250X.375	1.06	.56	.44	.187

Bulkhead Union 22BH

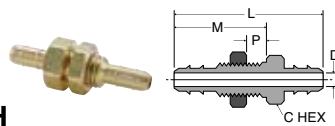

PART NO.	TUBE O.D.	TUBE I.D.	ST. THD.	C HEX	P MAX.	L	M	FLOW DIA. D	BLKHD HOLE DIA.
22BH-4-4	1/4	.170	5/16-24	7/16	.219	1.38	.78	.120	5/16
22BH-6-6	3/8	.250	3/8-24	7/16	.375	1.63	1.00	.187	3/8

Union 22CA

Tube to Compress-Align

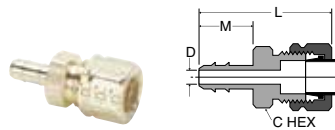

PART NO.	TUBE O.D.	TUBE I.D.	CA TUBE	C HEX	L	M	FLOW DIA. D
22CA-4-4	1/4	.170	1/4	7/16	1.15	.41	.120

Bulkhead Union 22CABH

Tube to Compress-Align

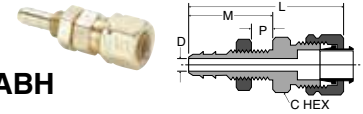

PART NO.	TUBE O.D.	TUBE I.D.	CA TUBE	ST. THD.	C HEX	P MAX	L	M	FLW DIA. D	BKHD HOLE DIA.
22CABH-4-4	1/4	.170	1/4	5/16-24	7/16	.219	1.53	.78	.120	5/16
22CABH-6-6	3/8	.250	3/8	3/8-24	9/16	.375	1.87	1.00	.187	3/8

Female Connector 26

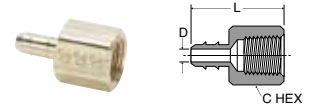

PART NO.	TUBE O.D.	TUBE I.D.	PIPE THREAD	C HEX	L	FLOW DIA. D
26-5/32-2	5/32	.096	1/8	1/2	.79	.062
26-4-2	1/4	.170	1/8	1/2	.91	.120
26-6-2	3/8	.250	1/8	1/2	.93	.187
26-6-4	3/8	.250	1/4	11/16	1.06	.187

Male Connector 27

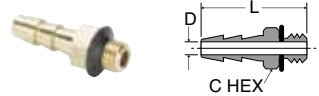

PART NO.	TUBE O.D.	TUBE I.D.	STRAIGHT THREAD	C HEX	L	FLOW DIA. D
27-1*	1/8	.062	10-32	1/4	.61	.052
27-2*	1/4	.125	10-32	1/4	.74	.093

*For vinyl tubing only.

Barb-to-Pipe Adapter 28

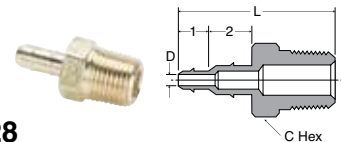

PART NO.	TUBE O.D. 1	TUBE I.D. 1	TUBE O.D. 2	TUBE I.D. 2	PIPE THD.	C HEX	L	FLOW DIA. D
28-4-5/32-2	5/32	.096	1/4	.170	1/8	7/16	1.07	.062

WARNING These products can expose you to chemicals including LEAD which is known to the state of California

[Click here for CADs, Product Specifications or to Configure Parts Online](#)

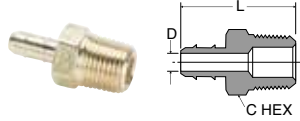

Male Connector 28

PART NO.	TUBE O.D.	TUBE I.D.	PIPE THREAD	C HEX	L	FLOW DIA. D
28-5/32-2	5/32	.096	1/8	7/16	.84	.062
28-4-1	1/4	.170	1/16	3/8	.93	.120
28-4-2	1/4	.170	1/8	7/16	.97	.120
28-4-4	1/4	.170	1/4	9/16	1.09	.120
28-4-10X32*	1/4	.170	10-32	1/4	.71	.093
28-6-2	3/8	.250	1/8	7/16	1.00	.187
28-6-4	3/8	.250	1/4	9/16	1.13	.187
28-8-4	1/2	.375	1/4	9/16	1.25	.312
28-8-6	1/2	.375	3/8	11/16	1.28	.312
28-8-8	1/2	.375	1/2	7/8	1.44	.312

*Straight thread

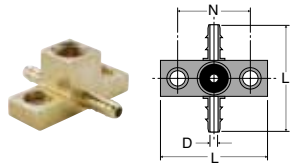

Adapter Tee 220

PART NO.	TUBE O.D.	TUBE I.D.	PIPE THREAD	L	N	FLOW DIA. D
220-4-2	1/4	.170	1/8	1.50	1.00	.120

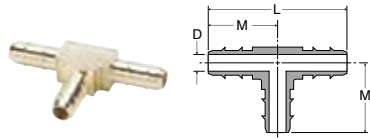

Union Tee 224

PART NO.	TUBE O.D.	TUBE I.D.	L	M	FLOW DIA. D
224-5/32	5/32	.096	1.00	.50	.062
224-4	1/4	.170	1.25	.63	.120
224-6	3/8	.250	1.38	.69	.187
224-8	1/2	.375	1.63	.81	.312

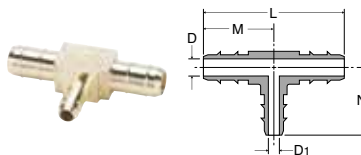

Union Tee 224 Combination Sizes

PART NO.	TUBE O.D.	TUBE I.D.	L	M	N	FLOW DIA. D	FLOW DIA. D1
224-4-4-5/32	1/4X5/32	.170X.096	1.25	.63	.50	.120	.062
224-6-6-5/32	3/8X5/32	.250X.096	1.38	.69	.50	.187	.062
224-6-6-4	3/8X1/4	.250X.170	1.38	.69	.62	.187	.120
224-8-8-4	1/2X1/4	.375X.170	1.62	.81	.65	.312	.120
224-8-8-6	1/2X3/8	.375X.250	1.62	.81	.69	.312	.187

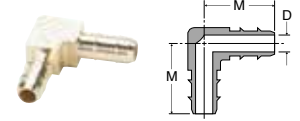

Union Elbow 225

PART NO.	TUBE O.D.	TUBE I.D.	M	FLOW DIA. D
225-5/32	5/32	.096	.50	.062
225-4-4	1/4	.170	.63	.120
225-6-6	3/8	.250	.63	.187
225-8-8	1/2	.375	.81	.312

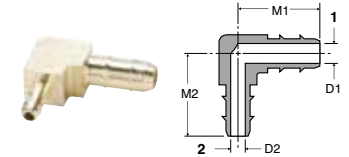

Union Elbow 225 Combination Size

PART NO.	TUBE O.D. 1	TUBE O.D. 2	TUBE I.D. 1	TUBE I.D. 2	M1	M2	FLOW DIA. D1	FLOW DIA. D2
225-4-5/32	1/4	5/32	.170	.096	.63	.50	.120	.062

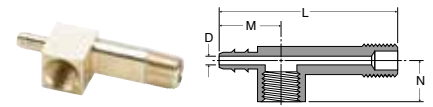

Gauge Tee 228

PART NO.	TUBE O.D.	TUBE I.D.	PIPE THREAD	L	M	N	FLOW DIA. D
228-4-2	1/4	.170	1/8	1.91	.66	.44	.120

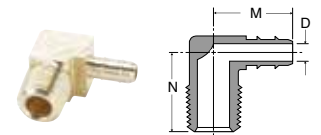

Male Elbow 229

PART NO.	TUBE O.D.	TUBE I.D.	PIPE THREAD	M	N	FLOW DIA. D
229-5/32-2	5/32	.096	1/8	.56	.63	.062
229-4-1	1/4	.170	1/16	.62	.60	.120
229-4-2	1/4	.170	1/8	.69	.63	.120
229-4-4	1/4	.170	1/4	.72	.72	.120
229-6-2	3/8	.250	1/8	.69	.69	.187
229-6-4	3/8	.250	1/4	.75	.75	.187
229-8-4	1/2	.375	1/4	.94	.74	.312
229-8-6	1/2	.375	3/8	.94	.81	.312

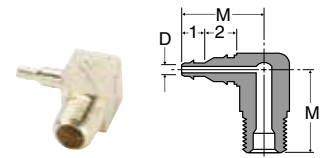

90° Elbow Barb Adapter 229

PART NO.	TUBE O.D. 1	TUBE I.D. 1	TUBE O.D. 2	TUBE I.D. 2	PIPE THREAD	M	FLOW DIA. D
229-4-5/32-2	5/32	.096	1/4	.170	1/8	.78	.062

WARNING These products can expose you to chemicals including LEAD which is known to the state of California

[Click here for CADs, Product Specifications or to Configure Parts Online](#)

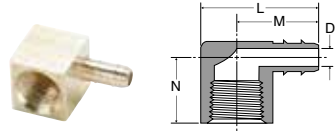

Female Elbow 230

PART NO.	TUBE O.D.	TUBE I.D.	PIPE THREAD	L	M	N	FLOW DIA. D
230-4-2	1/4	.170	1/8	.91	.66	.44	.120
230-6-4	3/8	.250	1/4	1.12	.78	.63	.187

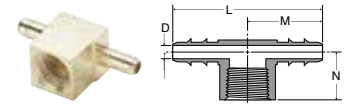

Female Branch Tee 237

PART NO.	TUBE O.D.	TUBE I.D.	PIPE THREAD	L	M	N	FLOW DIA. D
237-5/32-2	5/32	.096	1/8	1.06	.53	.44	.062
237-4-2	1/4	.170	1/8	1.34	.67	.49	.120

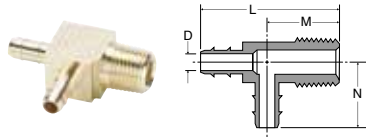

Male Run Tee 231

PART NO.	TUBE O.D.	TUBE I.D.	PIPE THREAD	L	M	N	FLOW DIA. D
231-4-2	1/4	.170	1/8	1.28	.66	.69	.120
231-6-2	3/8	.250	1/8	1.38	.69	.69	.187
231-6-4	3/8	.250	1/4	1.44	.75	.75	.187

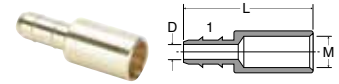

Solder Connector 238

PART NO.	TUBE O.D. 1	TUBE I.D. 1	L	M	FLOW DIA. D
238-4-4	1/4	.170	.91	.25	.120

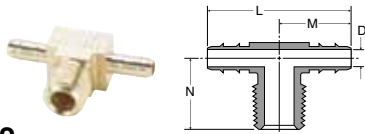

Male Branch Tee 232

PART NO.	TUBE O.D.	TUBE I.D.	PIPE THREAD	L	M	N	FLOW DIA. D
232-4-1	1/4	.170	1/16	1.33	.66	.65	.120
232-4-2	1/4	.170	1/8	1.38	.69	.66	.120
232-6-2	3/8	.250	1/8	1.38	.69	.69	.187
232-6-4	3/8	.250	1/4	1.50	.75	.75	.187

WARNING These products can expose you to chemicals including LEAD which is known to the state of California



Hose Barb Fittings

Parker's Hose Barb Fittings are an economical choice for general purpose fluid handling and pneumatics. Manufactured in both regular hose barb and beaded hose barb styles. Fittings are intended for use with 97HC hose clamps, similar type clamp or a crimped ferrule.

Product Features:

- All brass construction
- Fluorocarbon O-rings
- NPTF, SAE straight thread, metric thread ends
- Reusable
- Clamp required

Applications:

- Air Lines
- Water Line
- Cooling Lines

Compatible Tubing:

- Rubber Hose
- GPH Hose

Markets:

- Industrial
- Construction
- Heavy duty truck
- Mobile

Specifications:

Pressure Range Up to 150 PSI (10.3 bar)

Temperature Range -40° to +160° F (-40° to +71.1° C)



Assembly Instructions

1. Cut hose cleanly and squarely to length.
2. Slide clamp on hose.
3. Lubricate hose. Push hose on fitting until bottomed against stop ring or hex.
4. Position hose clamp as shown and secure with a screwdriver or wrench. Maintain "A" dimension for proper clamp positioning.

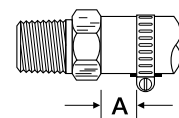

HOSE SIZE	HOSE CLAMP	A
3/16	97 HC-3	1/4
1/4	97 HC-3	1/4
5/16	97 HC-6	1/4
3/8	97 HC-6	1/8
1/2	97 HC-8	1/8
5/8	97 HC-12	1/8
3/4	97 HC-12	1/8

Beaded Hose Barb to Male Pipe 68HB

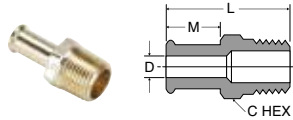

PART NO.	I.D. HOSE SIZE	PIPE THREAD	C HEX	L	M	FLOW DIA. D
68HB-6-6	3/8	3/8	11/16	1.53	.78	.281
68HB-8-4	1/2	1/4	5/8	1.56	.78	.375
68HB-8-6	1/2	3/8	11/16	1.53	.78	.406
68HB-8-8	1/2	1/2	7/8	1.84	.78	.406
68HB-10-6	5/8	3/8	3/4	1.62	.88	.501
68HB-10-8	5/8	1/2	7/8	1.92	.88	.501
68HB-12-8	3/4	1/2	7/8	1.98	.88	.564
68HB-12-12	3/4	3/4	1 1/16	2.04	.97	.625
68HB-16-12	1	3/4	1 1/8	2.12	1.00	.750
68HB-16-16	1	1	1.38	2.31	1.00	.812

Beaded Hose Barb to SAE Straight Thread 685HB

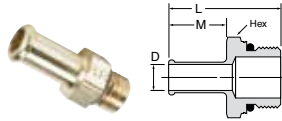

PART NO.	I.D. HOSE SIZE	STRAIGHT THREAD	C HEX	L	M	FLOW DIA. D
685HB-4-4	1/4	7/16-20	9/16	1.40	.78	.18
685HB-6-4	3/8	7/16-20	9/16	1.39	.78	.18
685HB-8-8	1/2	3/4-16	7/8	1.48	.78	.40
685HB-10-8	5/8	3/4-16	7/8	1.56	.78	.40
685HB-12-8	3/4	3/4-16	7/8	1.75	.97	.40
685HB-12-12	3/4	1 1/16-12	1 1/4	1.82	.97	.62
685HB-16-8	1	3/4-16	1 1/8	1.79	.97	.40
685HB-16-12	1	1 1/16-12	1 1/4	1.99	.97	.62

Note: Fluorocarbon o-ring is standard

Hose Barb to Metric Adaptor 68HB-X-MIX

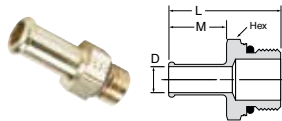

PART NO.	I.D. HOSE SIZE	METRIC THREAD	HEX	L	M	D
68HB-6-MI12	3/8	M12 X 1.5	11/16	1.50	.78	.24
68HB-6-MI14	3/8	M14 1.5	3/4	1.51	.78	.29
68HB-8-MI12	1/2	M12 X 1.5	11/16	1.50	.78	.24

Note: Fluorocarbon o-ring is standard

Stainless Steel Worm Drive Clamp 97HC

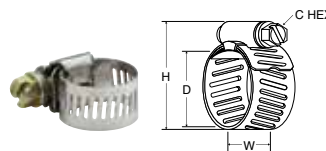

PART NO.	D MAX.	D MIN.	C HEX	H MAX.	W
97HC-3	.62	.25	.25	1.00	.31
97HC-6	.87	.38	.31	1.40	.50
97HC-8	1.00	.44	.31	1.53	.50
97HC-12	1.25	.50	.31	1.80	.50

Hose Mender 122HBL

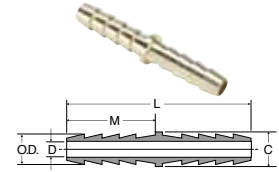

PART NO.	I.D. HOSE SIZE	C DIA.	L	M	O.D.	FLOW DIA. D
122HB-3	3/16	5/16	1.44	.69	.227	.125
122HBL-4	1/4	3/8	2.00	.97	.290	.187
122HBL-5	5/16	7/16	2.00	.97	.353	.250
122HBL-6	3/8	1/2	2.00	.97	.415	.281
122HBL-8	1/2	5/8	2.00	.97	.530	.375
122HBL-12	3/4	7/8	2.00	.97	.790	.562

Hose Barb to Male Pipe 125HB

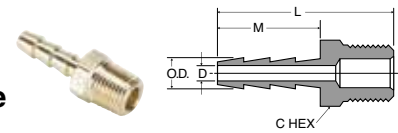

PART NO.	I.D. HOSE SIZE	PIPE THREAD	C HEX	L	M	O.D.	FLOW DIA. D
125HB-2-2	1/8	1/8	7/16	1.07	.50	.185	.093
125HB-3-2	3/16	1/8	7/16	1.25	.69	.227	.125
125HB-3-4	3/16	1/4	9/16	1.44	.69	.227	.125

Hose Barb to Male Pipe 125HBL

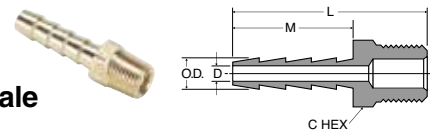

PART NO.	I.D. HOSE SIZE	PIPE THREAD	C HEX	L	M	O.D.	FLOW DIA. D
125HBL-4-2	1/4	1/8	7/16	1.54	.97	.290	.187
125HBL-4-4	1/4	1/4	9/16	1.72	.97	.290	.187
125HBL-4-6	1/4	3/8	11/16	1.77	.97	.290	.187
125HBL-5-2	5/16	1/8	7/16	1.54	.97	.353	.250
125HBL-5-4	5/16	1/4	9/16	1.72	.97	.353	.250
125HBL-5-6	5/16	3/8	11/16	1.77	.97	.353	.250
125HBL-6-2	3/8	1/8	7/16	1.54	.97	.415	.281
125HBL-6-4	3/8	1/4	9/16	1.72	.97	.415	.281
125HBL-6-6	3/8	3/8	11/16	1.77	.97	.415	.281
125HBL-6-8	3/8	1/2	7/8	1.97	.97	.415	.281
125HBL-8-4	1/2	1/4	9/16	1.72	.97	.530	.375
125HBL-8-6	1/2	3/8	11/16	1.77	.97	.530	.375
125HBL-8-8	1/2	1/2	7/8	1.97	.97	.530	.375
125HBL-8-12	1/2	3/4	1-1/16	1.98	.97	.530	.375
125HBL-10-6	5/8	3/8	11/16	1.77	.97	.645	.468
125HBL-10-8	5/8	1/2	7/8	1.97	.97	.645	.468
125HBL-10-12	5/8	3/4	1-1/16	1.98	.97	.645	.468
125HBL-12-8	3/4	1/2	7/8	1.97	.97	.790	.562
125HBL-12-12	3/4	3/4	1-1/16	1.98	.97	.790	.562
125HBL-16-12	1	3/4	1-1/16	2.18	1.17	1.02	.750
125HBL-16-16	1	1	1-3/8	2.36	1.17	1.02	.875

WARNING: These products can expose you to chemicals including NICKEL or LEAD, which are known to the state of California to cause cancer.

[Click here for CADs, Product Specifications or to Configure Parts Online](#)

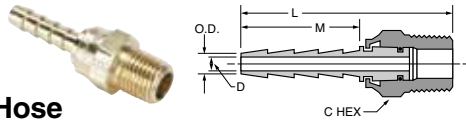

Male Swivel Hose Barb 125HBLSV

PART NO.	I.D. HOSE SIZE	PIPE THREAD	C HEX	L	M	O.D.	FLOW DIA. D
125HBLSV-4-4	1/4	1/4	11/16	2.14	.97	.290	.187
125HBLSV-6-4	3/8	1/4	11/16	2.14	.97	.415	.250
125HBLSV-6-6	3/8	3/8	11/16	2.14	.97	.415	.250
125HBLSV-8-8	1/2	1/2	7/8	2.48	.97	.530	.375

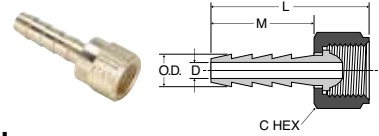

Hose Barb to Swivel Female Ball-End 128HBLSV

PART NO.	I.D. HOSE SIZE	FEMALE N.P.S.M. THREAD	C HEX	L	M	O.D.	FLOW DIA. D
128HBLSV-4-4	1/4	1/4	5/8	1.50	.97	.290	.187
128HBLSV-5-4	5/16	1/4	5/8	1.50	.97	.353	.250
128HBLSV-6-4	3/8	1/4	5/8	1.63	.97	.415	.250
128HBLSV-6-6	3/8	3/8	3/4	1.50	.97	.415	.281
128HBLSV-8-8	1/2	1/2	29/32	1.52	.97	.530	.375

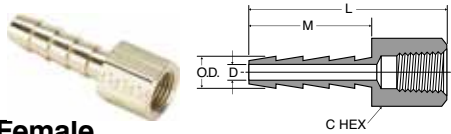

Hose Barb to Female Pipe 126HBL

PART NO.	I.D. HOSE SIZE	PIPE THREAD	C HEX	L	M	O.D.	FLOW DIA. D
126HBL-4-2	1/4	1/8	1/2	1.47	.97	.290	.187
126HBL-4-4	1/4	1/4	11/16	1.66	.97	.290	.187
126HBL-5-4	5/16	1/4	11/16	1.58	.97	.353	.250
126HBL-6-2	3/8	1/8	1/2	1.47	.97	.415	.281
126HBL-6-4	3/8	1/4	11/16	1.66	.97	.415	.281
126HBL-6-6	3/8	3/8	13/16	1.69	.97	.415	.281
126HBL-8-6	1/2	3/8	13/16	1.69	.97	.530	.375
126HBL-8-8	1/2	1/2	1	1.73	.97	.530	.375
126HBL-12-12	3/4	3/4	1-1/4	1.92	.97	.790	.562

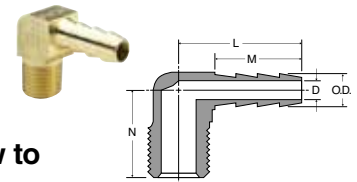

Hose Barb 90° Elbow to Male Pipe 129HB

PART NO.	I.D. HOSE SIZE	PIPE THREAD	L	M	N	O.D.	FLOW DIA. D
129HB-3-2	3/16	1/8	.97	.69	.66	.227	.173
129HB-4-2	1/4	1/8	1.04	.76	.66	.290	.187
129HB-4-4	1/4	1/4	1.06	.76	.82	.290	.187
129HB-4-6	1/4	3/8	1.19	.76	.84	.290	.187
129HB-5-2	5/16	1/8	1.06	.76	.66	.353	.234
129HB-5-4	5/16	1/4	1.12	.76	.84	.353	.234
129HB-5-6	5/16	3/8	1.19	.76	.84	.353	.234
129HB-6-2	3/8	1/8	1.32	.97	.75	.415	.219
129HB-6-4	3/8	1/4	1.32	.97	.94	.415	.281
129HB-6-6	3/8	3/8	1.50	.97	1.06	.415	.281
129HB-6-8	3/8	1/2	1.52	.97	1.25	.415	.281
129HB-8-4	1/2	1/4	1.53	.97	1.06	.530	.375
129HB-8-6	1/2	3/8	1.53	.97	1.06	.530	.375
129HB-8-8	1/2	1/2	1.53	.97	1.25	.530	.375
129HB-12-12	3/4	3/4	1.33	.79	1.27	.790	.562

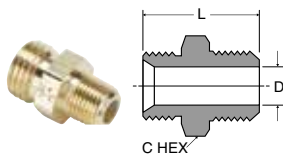

Ball-End Joint Adapter to Male Pipe 127HB

For use with 128HBLSV

PART NO.	MALE N.P.S.M. THREAD	MALE N.P.T. THREAD	C HEX	L	FLOW DIA. D
127HB-4-2	1/4	1/8	9/16	.91	.219
127HB-4-4	1/4	1/4	9/16	1.10	.281
127HB-6-4	3/8	1/4	11/16	1.10	.312
127HB-6-6	3/8	3/8	11/16	1.15	.406
127HB-8-6	1/2	3/8	7/8	1.25	.406
127HB-8-8	1/2	1/2	7/8	1.50	.531

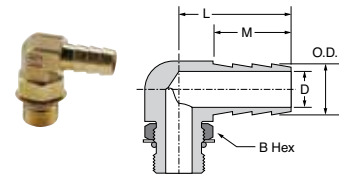

Hose Barb Elbow to SAE Straight Thread 1295HB

PART NO.	I.D. HOSE SIZE	STRAIGHT THREAD	B HEX	L	M	O.D.	FLOW DIA. D
1295HB-6-6	3/8	9/16-18	11/16	1.10	1.11	.410	.270

Note: Fluorocarbon o-ring is standard

WARNING: These products can expose you to chemicals including NICKEL or LEAD, which are known to the state of California to cause cancer.

Click here for CADs, Product Specifications or to Configure Parts Online

Hose Barb 45° Elbow to Male Pipe 139HB

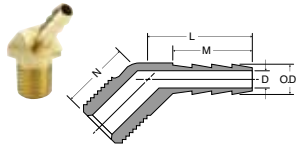

PART NO.	I.D. HOSE SIZE	PIPE THREAD	L	M	N	O.D.	FLOW DIA. D
139HB-4-2	1/4	1/8	.91	.76	.68	.290	.187
139HB-4-4	1/4	1/4	1.00	.76	.68	.290	.187
139HB-6-4	3/8	1/4	1.00	.76	.68	.415	.281

Hose Barb Tee to SAE Straight Thread 1725HB

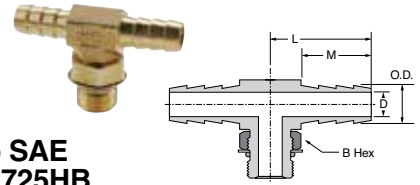

PART NO.	I.D. HOSE SIZE	STRAIGHT THREAD	B HEX	L	M	O.D.	FLOW DIA. D
1725HB-6-6	3/8	9/16-18	11/16	1.10	.76	.420	.280

Note: Fluorocarbon o-ring is standard

Hose Barb to Swivel 45° Female Flare 146HBLFSV

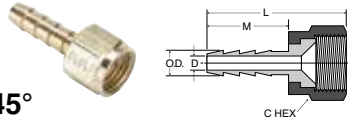

PART NO.	I.D. HOSE SIZE	STRAIGHT THREAD	C HEX	L	M	O.D.	FLOW DIA. D
146HBLFSV-4-4	1/4	7/16-20	9/16	1.55	.97	.290	.187
146HBLFSV-4-6	1/4	5/8-18	3/4	1.72	.97	.290	.187
146HBLFSV-6-6	3/8	5/8-18	3/4	1.72	.97	.415	.281

Hose Barb Tee to Male Pipe 171HB

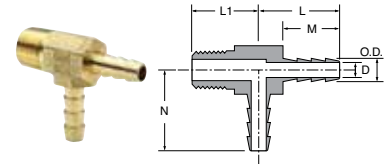

PART NO.	I.D. HOSE SIZE	PIPE THREAD	L	L1	M	N	O.D.	FLOW DIA. D
171HB-4-4	1/4	1/4	1.10	.85	.76	1.10	.290	.187

Beaded Hose Barb Elbow to SAE Straight Thread 1695HB

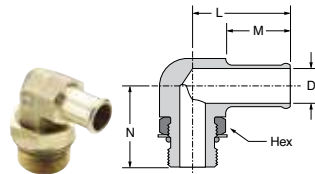

PART NO.	HOSE SIZE	STRAIGHT THREAD	HEX	L	M	N	D
1695HB-6-4	3/8	7/16-20	9/16	1.09	.78	1.10	.18
1695HB-8-6	1/2	9/16-18	9/16	1.10	.78	1.11	.30
1695HB-8-8	1/2	3/4-16	7/8	1.28	.78	1.42	.40
1695HB-10-8	5/8	3/4-16	7/8	1.47	.88	1.47	.40
1695HB-10-10	5/8	7/8-14	1	1.41	.88	1.60	.50
1695HB-12-8	3/4	3/4-16	7/8	1.47	.97	1.47	.40
1695HB-12-10	3/4	7/8-14	1	1.60	.97	1.62	.50
1695HB-12-12	3/4	1 1/16-12	1	1.60	.97	1.64	.62
1695HB-16-12	1	1 1/16-12	1 1/4	1.60	.97	1.75	.60

Note: Fluorocarbon o-ring is standard

Beaded Hose Barb 45° Elbow Tube to Male Pipe 179HB

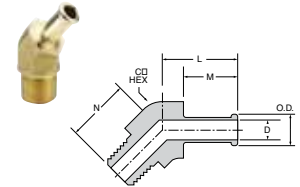

PART NO.	I.D. HOSE SIZE	NPTF THREAD	C HEX	L	M	N	O.D.	FLOW DIA. D
179HB-6-4	3/8	1/4-18	.75	1.09	.78	.93	.45	.28
179HB-6-6	3/8	3/8-18	.75	1.09	.78	.93	.45	.28
179HB-10-8	5/8	1/2-14	.81	1.19	.78	1.13	.70	.50
179HB-12-8	3/4	1/2-14	.81	1.19	.78	1.13	.83	.56

Beaded Hose Barb 45° Elbow Tube to Straight Thread 1795HB

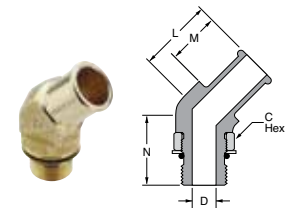

PART NO.	I.D. HOSE SIZE	STRAIGHT THREAD	C HEX	L	M	N	FLOW DIA. D
1795HB-8-8	1/2	3/4-16	7/8	1.12	.78	1.16	.400
1795HB-10-8	5/8	3/4-16	7/8	1.22	.88	1.16	.398
1795HB-12-8	3/4	3/4-16	7/8	1.22	.88	1.16	.398
1795HB-12-12	3/4	1 1/16-12	1 1/4	1.35	.97	1.65	.620
1795HB-16-12	1	1 1/16-12	1 1/4	1.38	.97	1.47	.620

Note: Fluorocarbon o-ring is standard

Beaded Elbow to Metric Adaptor 169HB-X-MIX

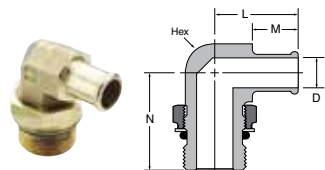

PART NO.	HOSE SIZE	METRIC THREAD	HEX	L	M	N	D
169HB-10-MI27	5/8	M27 X 2.0	7/8	1.41	.78	1.63	.50
169HB-16-MI27	1	M27 X 2.0	1	1.67	.97	1.68	.71
169HB-16-MI33	1	M33 X 2.0	1 5/16	1.75	.97	1.90	.84

Note: Fluorocarbon o-ring is standard

WARNING: These products can expose you to chemicals including NICKEL or LEAD, which are known to the state of California to cause cancer.

[Click here for CADs, Product Specifications or to Configure Parts Online](#)

Beaded Hose Barb 45° Elbow to Metric Thread 179HB-X-MIX

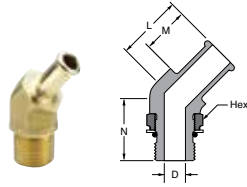

PART NO.	HOSE SIZE	METRIC THREAD	HEX	L	M	N	D
179HB-12-MI18	3/4	M18 X 1.5	13/16	1.15	.78	1.16	.44
179HB-16-MI27	1	M27 X 2.0	1 1/16	1.51	.97	1.71	.71

Note: Fluorocarbon o-ring is standard

Beaded Hose Barb 90° Elbow Tube to Male Pipe 269HB

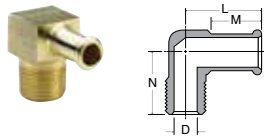

PART NO.	I.D. HOSE SIZE	PIPE THREAD	L	M	N	FLOW DIA. D
269HB-6-6	3/8	3/8	1.19	.78	.88	.281
269HB-8-4	1/2	1/4	1.16	.78	.99	.310
269HB-8-6	1/2	3/8	1.16	.78	1.08	.406
269HB-8-8	1/2	1/2	1.28	.78	1.25	.406
269HB-10-4	5/8	1/4	1.13	.78	.99	.312
269HB-10-6	5/8	3/8	1.16	.78	.99	.406
269HB-10-8	5/8	1/2	1.28	.78	1.25	.501
269HB-12-8	3/4	1/2	1.28	.78	1.25	.563
269HB-12-12	3/4	3/4	1.33	.78	1.27	.625

Beaded Hose Barb 45° Elbow Tube to Male Pipe 279HB

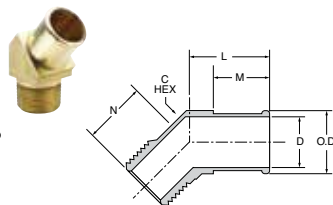

PART NO.	I.D. HOSE SIZE	NPTF THREAD	C HEX	L	M	N	O.D.	FLOW DIA. D
279HB-16-12	1	3/4-14	1.12	1.38	.97	1.13	1.06	.720

0123 Barbed Adapter for Rubber Hose BSPT

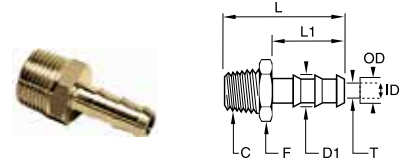

PART NO.	OD MM	ID MM	C BSPT	D1 MM	F MM	L MM	L1 MM	T MIN MM	WT. KG
0123 04 10	4	6	R1/8	6	10	34	22.5	3.3	.008
0123 06 10	6	8	R1/8	8	10	34	22.5	5	.009
0123 07 10	7	9	R1/8	9	10	34	22.5	5	.009
0123 07 13	7	9	R1/4	9	14	38.5	22.5	6	.018
0123 07 17	7	9	R3/8	9	17	39	22.5	6	.023
0123 10 10	10	12.2	R1/8	12.2	13	34	22.5	5	.014
0123 10 13	10	12.2	R1/4	12.2	14	38.5	22.5	7	.021
0123 10 17	10	12.2	R3/8	12.2	17	39	22.5	9.5	.023
0123 12 17	12	14	R3/8	14	17	46	29.5	11	.026
0123 13 13	13	15	R1/4	15	17	45.5	29.5	7	.027
0123 13 17	13	15	R3/8	15	17	46	29.5	11	.027
0123 13 21	13	15	R1/2	15	22	50.5	29.5	12	.047
0123 16 17	16	18.5	R3/8	18.5	19	54.5	38	11	.040
0123 16 21	16	18.5	R1/2	18.5	22	59	38	14	.056
0123 16 27	16	18.5	R3/4	18.5	27	62	38	15	.082
0123 19 17	19	21.5	R3/8	21.5	22	54.5	38	11	.046
0123 19 21	19	21.5	R1/2	21.5	22	59	38	14	.058
0123 19 27	19	21.5	R3/4	21.5	27	62	38	18	.083
0123 25 27	25	26.7	R3/4	26.7	27	62	38	18	.083
0123 25 34	25	27	R1	27	36	65	38	24	.124
0123 32 34	32	34.5	R1	34.5	36	70	43	24	.144

WARNING: These products can expose you to chemicals including NICKEL or LEAD, which are known to the state of California to cause cancer.

[Click here for CADs, Product Specifications or to Configure Parts Online](#)

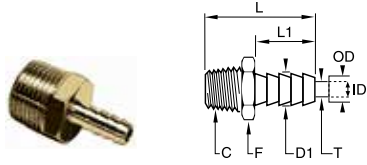

0136 Barbed Adapter for Nylon Tube BSPT

PART NO.	OD MM	ID MM	C BSPT	D1 MM	F MM	L MM	L1 MM	T MIN MM	WT. KG
0136 06 10	6	4	R1/8	6.4	10	26.5	15	4	.007
0136 06 13	6	4	R1/4	6.4	14	31	15	4	.015
0136 06 17	6	4	R3/8	6.4	17	31.5	15	4	.020
0136 08 13	8	6	R1/4	8.4	14	31	15	6	.016
0136 08 17	8	6	R3/8	8.4	17	31.5	15	6	.020
0136 08 21	8	6	R1/2	8.4	22	36	15	6	.039
0136 10 13	10	8	R1/4	10.7	14	36	20	7	.019
0136 10 17	10	8	R3/8	10.7	17	36.5	20	8	.023
0136 10 21	10	8	R1/2	10.7	22	41	20	8	.040
0136 12 13	12	10	R1/4	12.7	14	36	20	7	.019
0136 12 17	12	10	R3/8	12.7	17	36.5	20	10	.023
0136 12 21	12	10	R1/2	12.7	22	41	20	10	.042
0136 12 27	12	10	R3/4	12.7	27	44	20	10	.072
0136 14 17	14	12	R3/8	13.7	17	36.5	20	11	.023
0136 14 21	14	12	R1/2	13.7	22	41	20	11	.041
0136 14 27	14	12	R3/4	13.7	27	44	20	11	.071

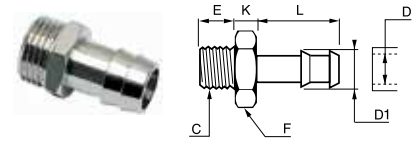

0931 Nickel Plated Hose to Male BSPP

PART NO.	D MM	C BSPP	D1 MM	E MM	F MM	K MM	L MM	WT. KG
0931 06 10	6	G1/8	7	6	12	4	20	0.008
0931 06 13	6	G1/4	7	8	14	5	20	0.013
0931 07 10	7	G1/8	8	6	12	4	20	0.009
0931 07 13	7	G1/4	8	8	14	5	20	0.017
0931 07 17	7	G3/8	8	9	19	5	20	0.022
0931 08 10	8	G1/8	9	6	12	4	20	0.009
0931 08 13	8	G1/4	9	8	14	5	20	0.014
0931 08 17	8	G3/8	9	9	19	5	20	0.022
0931 10 13	10	G1/4	12	8	14	5	20	0.016
0931 10 17	10	G3/8	12	9	19	5	20	0.023
0931 10 21	10	G1/2	12	10	22	6	22	0.032
0931 15 17	15	G3/8	17	9	19	6	24	0.030
0931 15 21	15	G1/2	17	10	22	6	24	0.036
0931 18 21	18	G1/2	20	10	22	6	24	0.043

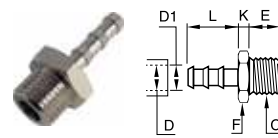

0191 Nickel Plated Hose to Male BSPP

PART NO.	D MM	C BSPP	D1 MM	E MM	F MM	K MM	L MM	WT. KG
0191 04 13	4	G1/4	6	9.5	17	5	22.5	.019
0191 07 13	7	G1/4	9	9.5	17	5	22.5	.021
0191 07 21	7	G1/2	9	11	27	7	29.5	.065
0191 10 13	10	G1/4	12.2	9.5	17	5	22.5	.021
0191 10 21	10	G1/2	12.2	11	27	7	29.5	.060
0191 13 13	13	G1/4	15.2	9.5	17	5	22.5	.023
0191 13 21	13	G1/2	15.2	11	27	7	29.5	.058
0191 16 21	16	G1/2	18.5	11	27	7	36.5	.069

WARNING These products can expose you to chemicals including NICKEL or LEAD, which are known to the state of California to cause cancer.



Industrial Adapters

Pipe Fittings

Metric Adapters

Nickel Plated Metric Adapters

ISO Port Adapters

Stainless Steel Adapters

Garden Hose Fittings





GOODYEAR
RUBBER PRODUCTS, INC.

📞 727-342-5088

You can also email us at
GRP@goodyearrubberproducts.com

■ Male Pipe to Male Pipe

215PN

Close Nipple
p. F10



215PNL

Long Nipple
p. F10



216P

Hex Nipple
p. F11



1204P

Male Elbow
p. F12



■ Male NPT to Male BSPT

0121

Hex Nipple
p. F16



■ Male Pipe to Female Pipe

209P

Bushing
p. F9



222P

Adapter
p. F11



1202P-2202P

Street Elbow
p. F12



2224P

Male Branch tee
p. F12



2225P

Street Tee
p. F12



2214P

45° Street Elbow
p. F13



■ Male BSPT to Female BSPP

0144

Street Elbow
p. F15



0158

Male Branch Tee
p. F16



0163

Bushing
p. F17



0913/0921

Street Elbow
p. F18



0911

Y Connector
p. F18



0916/0923

Male Branch Tee
p. F19



0917/0924

Male Run Tee
p. F19



0928

Female Branch Tee
p. F19



0909

Cross
p. F19



0904

Bushing
p. F20



■ Male NPT to Female BSPP

0164

NPT-Female BSPP
p. F15



■ Male BSPT to Female NPT

F3HG

Adapter - Male BSPT
p. F15



■ Female BSPP to Male BSPP

0169

Adapter
p. F17



0903

Adapter Reducer
p. F19



0905

Bushing
p. F20



0906

Adapter
p. F20



0907

Extended Adapter
p. F20



⚠ WARNING These products can expose you to chemicals including CARBON BLACK or LEAD, which are known to the state of California to cause cancer.

■ Male BSPT

0152
Union Elbow
p. F15



0929
3 Piece Adapter
p. F16



0914/0922
Union Elbow
p. F18



0927
Union Tee
p. F19



0900
Hex Nipple
p. F20



■ Male BSPT to Male BSPP

0192
Hex Nipple
p. F21



■ Male BSPP

0901
Hex Nipple
p. F21



■ Female Pipe to Female Pipe

207ACBH
Anchor Coupling
p. F9



207ACBH-S
Sealed Bulkhead
p. F9



207P
Coupling
p. F9



208P
Reducer Coupling
p. F9



212P
Union
p. F10



1200P-2200P
Union Elbow
p. F11



1203P-2203P
Union Tee
p. F12



2200PDE
Drop-Ear Elbow
p. F13



1201-2201P
45° Female Elbow
p. F13



2205P
Cross
p. F13



■ Female BSPP

0143
Union Elbow
p. F15



0145
Union Tee
p. F15



0117
Bulkhead
p. F16



0155
Coupling
p. F17



0168
Adapter
p. F17



0912
Union Elbow
p. F18



0910
Union Y
p. F18



0915
Union Tee
p. F18



0908
Cross
p. F19



0920
Bulkhead
p. F20



0902
Coupling
p. F21



⚠ WARNING These products can expose you to chemicals including CARBON BLACK or LEAD, which are known to the state of California to cause cancer.

■ Flare to Metric Straight Thread

48F-X-MIX
Male Connector
p. F23



149F-X-MIX
Male Elbow
p. F23



159F-X-MIX
45° Male Elbow
p. F23



■ Hose to Metric Straight Thread

68HB-X-MIX
Male Connector
p. F23



169HB-X-MIX
Male Elbow
p. F23



179HB-X-MIX
45° Male Elbow
p. F23



■ Tube to Metric Straight Thread

68NTA-X-MIX
Male Connector
p. F23



■ Female Pipe to Metric Straight Thread

222P-X-MIX
Adapter
p. F15, F23



■ Stainless Steel Adapters

1844
Equal Male Stud
Elbow Male BSPT
to Female BSPP
p. F24



1843
1843 Equal Elbow
Female BSPP
p. F24



1845
Equal Tee Female
BSPP
p. F24



1871
1871 Bulkhead
Adapter NPT
p. F24



1817
Bulkhead Adapter
BSPP
p. F24



1855
Double Female
Sleeve BSPP
p. F24



1870
Double Female
Sleeve NPT
p. F25



1862
Reducer/Expander
Double Female
Sleeve, BSPP
p. F25



1864
Adapter Male NPT
to Female BSPP
p. F25



1867
Adapter Male
BSPT to
Female NPT
p. F25



1872
Reducer Male/
Female NPT
p. F25



1863
Reducer Male
BSPT to Female
BSPP
p. F25



1873
Expander Male/
Female NPT
p. F26



1861
Expander
Male BSPT to
Female BSPP
p. F26



1821
Adapter Male NPT
p. F26



1821
Adapter Male
BSPT
p. F26



1823
Tailpiece Adapter
For Rubber Hose
Male NPT
p. F26



■ Flare to Female Garden Hose

50GHSV
Swivel Connector
p. F28



■ Male Pipe to Male Garden Hose

69GH-70GH-71GH
Male Pipe
p. F28



⚠ WARNING These products can expose you to chemicals including CARBON BLACK or LEAD, which are known to the state of California to cause cancer.

■ Garden Hose to Garden Hose

75GH
Connector
p. F28



■ Garden Hose to Female Pipe

78GH-79GH-80GH-81GH
Female Pipe
p. F28



■ Female Garden Hose to Male Pipe

82GH-83GH
Female Hose
p. F28



88GH
Swivel Connector
p. F28



■ Female Garden Hose to Female Pipe

98GH-99GH
Hose to Pipe
p. F28



98GHSV-99GHSV
Swivel Connector
p. F28



■ Female Garden Hose

101GHSV
Swivel Nut Connector
p. F28



■ Barb to Male Garden Hose

53GH-54GH-55GH
Hose Barb
p. F28



■ Barb to Female Garden Hose

90GH
Swivel Connector
p. F28



■ Auxiliary Component

210P
Lock Nut
p. F10



211P
Square Head Plug
p. F10



213P
Cap
p. F10



218P
Hex Head Plug
p. F11



219P
Countersunk Plug
p. F11



220P
Slotted Head Plug
p. F11



94GH
Hose Nut
p. F28



95GH
Hose Nut Reducer
p. F29



96GH
Hose Cap
p. F29



901GH
Washer
p. F29



1163-60-BPD
Coupler
p. F29



1163-61-BPD
Nipple
p. F29



⚠ WARNING These products can expose you to chemicals including CARBON BLACK or LEAD, which are known to the state of California to cause cancer.



Pipe Fittings

Parker's Pipe Fittings meet all functional requirements of SAE J530 and SAE J531. All threads on the pipe fittings are made to dryseal standards.

Product Features:

- All brass construction
- Meets functional requirements of SAE J530 and SAE J531
- Threads made to dryseal standards
- Both forgings and extrusions available

Markets:

- Industrial
- Construction
- Heavy duty truck
- Mobile
- Factory/process automation

Applications:

- Air Lines
- Water Line
- Cooling Lines

Specifications:

Pressure Range Up to 1000 PSI (68.9 bar)

Temperature Range -65° to +250° F (-53.9° to +121.1° C)

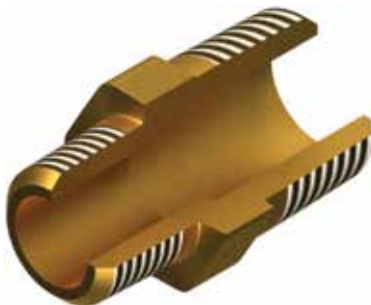

Assembly Instructions

Straight Fittings

1. Hand tighten external thread into internal thread
2. Tighten an additional 2 turns with a wrench up to 1/2" male pipe thread.
3. Above 1/2" 1 1/2 to 2 1/2 turns.

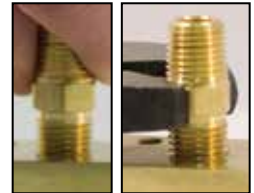

Elbow or Tee Fittings

1. Hand tighten external thread into internal thread
2. Tighten an additional 1 to 1 1/2 turns with a wrench
3. Tighten fitting, clockwise to align with tubing. (Never counter clockwise)

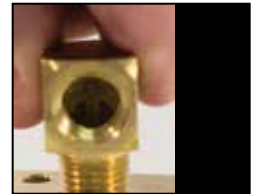

Note: To minimize the possibility of a leaking threaded joint after assembling Male to female pipe threads, neither end should be backed out (loosened) Once the assembly has been made.



[Click here for CADs, Product Specifications or to Configure Parts Online](#)

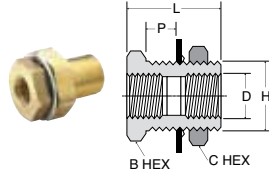

Bulkhead 207ACBH

PART NO.	FEAMLE PIPE THREAD	STRAIGHT THREAD	MAX. BULK HEAD P	B HEX	C HEX	L	BLKHD HOLE DIA. H	FLOW DIA. D
207ACBH-2	1/8	5/8-18	.89	7/8	15/16	1.50	5/8	.339
207ACBHS-2	1/8	5/8-18	.35	7/8	15/16	.96	5/8	.339
207ACBH-4	1/4	3/4-16	.81	1	1-1/8	1.50	3/4	.441
207ACBHS-4	1/4	3/4-16	.26	1	1	.94	3/4	.441
207ACBH-6	3/8	1-14	.62	1-1/8	1-1/4	1.31	1	.571
207ACBH-8	1/2	1-1/8-14	.75	1-1/4	1-3/8	1.50	1-1/8	.703
207ACBH-12	3/4	1-5/16-12	.65	1-1/2	1-1/2	1.50	1-5/16	.906
207ACBH-16*	1	1-5/8-14	1.00	2	2	1.68	1-5/8	1.140

*Lock Washer not Available

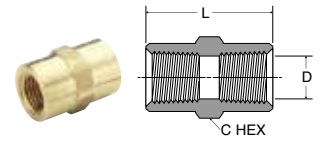

Coupling 207P

PART NO.	PIPE THREAD	C HEX	L	FLOW DIA. D
207P-2	1/8	9/16	.75	.339
207P-4	1/4	3/4	1.12	.441
207P-6	3/8	7/8	1.12	.571
207P-8	1/2	1-1/16	1.50	.703
207P-12	3/4	1-3/8	1.53	.906

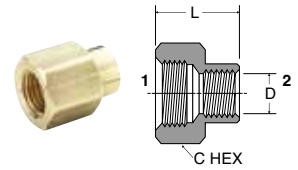

Reducer Coupling 208P

PART NO.	1 PIPE THREAD	2 PIPE THREAD	C HEX	L	FLOW DIA. D
208P-4-2	1/4	1/8	3/4	.97	.339
208P-6-4	3/8	1/4	7/8	1.16	.441
208P-8-4	1/2	1/4	1-1/16	1.28	.441
208P-8-6	1/2	3/8	1-1/16	1.38	.571
208P-12-6	3/4	3/8	1-3/8	1.32	.571
208P-12-8	3/4	1/2	1-3/8	1.50	.703

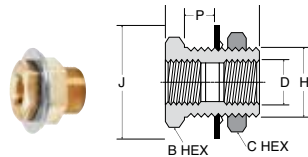

Sealed Bulkhead 207ACBH-S

PART NO.	FEAMLE PIPE THREAD	STRAIGHT THREAD	MAX. BULK HEAD P	B HEX	C HEX	J	L	BLKHD HOLE DIA. H	FLOW DIA. D
207ACBH-2-S	1/8	5/8-18	.84	7/8	15/16	1.19	1.50	.656	.339
207ACBHS-2-S	1/8	5/8-18	.30	7/8	15/16	1.19	.96	.656	.339
207ACBH-4-S	1/4	3/4-16	.75	1	1-1/8	1.31	1.50	.781	.441
207ACBHS-4-S	1/4	3/4-16	.20	1	1	1.31	.94	.781	.441
207ACBH-6-S	3/8	1-14	.56	1-1/8	1-1/4	1.75	1.31	1.031	.571

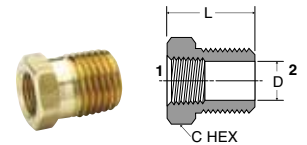

Bushing 209P

PART NO.	1 PIPE THREAD	2 PIPE THREAD	C HEX	L	FLOW DIA. D
209P-4-2	1/8	1/4	9/16	.75	.339
209P-6-2	1/8	3/8	11/16	.75	.339
209P-6-4	1/4	3/8	3/4	.75	.441
209P-8-2	1/8	1/2	7/8	1.00	.339
209P-8-4	1/4	1/2	7/8	1.00	.441
209P-8-6	3/8	1/2	7/8	1.00	.571
209P-12-2	1/8	3/4	1-1/8	1.00	.339
209P-12-4	1/4	3/4	1-1/8	1.00	.441
209P-12-6	3/8	3/4	1-1/8	1.00	.571
209P-12-8	1/2	3/4	1-1/8	1.00	.703
209P-16-8	1/2	1	1-3/8	1.31	.703
209P-16-12	3/4	1	1-3/8	1.31	.906



Sealing Washer Kit (10 pcs)

PART NO.	INNER DIA.	OUTER DIA.
207ACBH-WSHR-2	.625	1.19
207ACBH-WSHR-4	.75	1.31
207ACBH-WSHR-6	1.00	1.75

[Click here for CADs, Product Specifications or to Configure Parts Online](#)

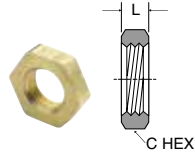

Lock Nut 210P

PART NO.	PIPE THREAD	C HEX	L
210P-2	1/8 NPSL	11/16	.19
210P-4	1/4 NPSL	7/8	.25
210P-6	3/8 NPSL	1	.25
210P-8	1/2 NPSL	1-1/8	.25

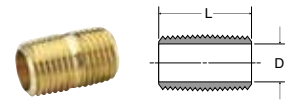

Close Nipple 215PN

PART NO.	PIPE THREAD	L	FLOW DIA. D
215PN-2	1/8	.75	.281
215PN-4	1/4	.88	.375
215PN-6	3/8	1.00	.500
215PN-8	1/2	1.13	.625
215PN-12	3/4	1.31	.750

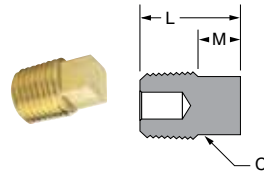

Square-Head Plug 211P

PART NO.	PIPE THREAD	C	L	M
211P-2	1/8	9/32	.59	.25
211P-4	1/4	3/8	.80	.29
211P-6	3/8	7/16	.83	.32
211P-8	1/2	9/16	1.07	.39
211P-12	3/4	5/8	1.14	.45

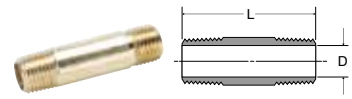

Long Nipple 215PNL

PART NO.	PIPE THREAD	L	FLOW DIA. D
215PNL-2-15	1/8	1-1/2	.250
215PNL-4-15	1/4	1-1/2	.375
215PNL-6-15	3/8	1-1/2	.500
215PNL-8-15	1/2	1-1/2	.625
215PNL-2-20	1/8	2	.250
215PNL-4-20	1/4	2	.375
215PNL-6-20	3/8	2	.500
215PNL-8-20	1/2	2	.625
215PNL-2-25	1/8	2-1/2	.250
215PNL-4-25	1/4	2-1/2	.375
215PNL-6-25	3/8	2-1/2	.500
215PNL-8-25	1/2	2-1/2	.625
215PNL-2-30	1/8	3	.250
215PNL-4-30	1/4	3	.375
215PNL-6-30	3/8	3	.500
215PNL-8-30	1/2	3	.625
215PNL-2-35	1/8	3-1/2	.250
215PNL-4-35	1/4	3-1/2	.375
215PNL-6-35	3/8	3-1/2	.500
215PNL-8-35	1/2	3-1/2	.625

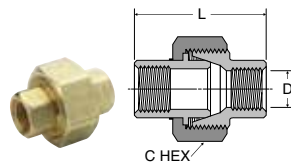

Union 212P

PART NO.	PIPE THREAD	C HEX	L	D
212P-4	1/4	1-3/16	1.54	.441
212P-6	3/8	1-1/4	1.76	.571

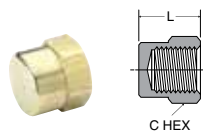

Cap 213P

PART NO.	PIPE THREAD	C HEX	L
213P-2	1/8	9/16	.50
213P-4	1/4	11/16	.63
213P-6	3/8	13/16	.63
213P-8	1/2	1-1/16	.87
213P-12	3/4	1-1/4	.89

[Click here for CADs, Product Specifications or to Configure Parts Online](#)

Hex Nipple 216P

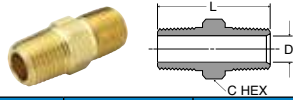

PART NO.	PIPE THREAD	C HEX	L	FLOW DIA. D
216P-2	1/8	7/16	.97	.220
216P-4	1/4	9/16	1.38	.314
216P-6	3/8	11/16	1.41	.440
216P-8	1/2	7/8	1.81	.564
216P-12	3/4	1-1/16	1.81	.752

Slotted-Head Plug 220P

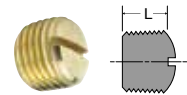

PART NO.	PIPE THREAD	L
220P-2	1/8	.31
220P-4	1/4	.42
220P-6	3/8	.43

Hex Nipple Reducers 216P

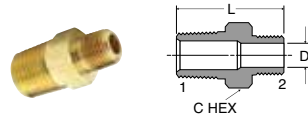

PART NO.	1 PIPE THREAD	2 PIPE THREAD	C HEX	L	FLOW DIA. D
216P-4-2	1/4	1/8	9/16	1.19	.220
216P-6-2	3/8	1/8	11/16	1.22	.220
216P-6-4	3/8	1/4	11/16	1.41	.314
216P-8-4	1/2	1/4	7/8	1.62	.314
216P-8-6	1/2	3/8	7/8	1.62	.440
216P-12-8	3/4	1/2	1-1/16	1.80	.564

Adapter 222P

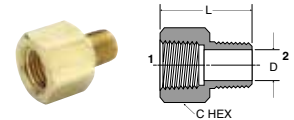

PART NO.	1 PIPE THREAD	2 PIPE THREAD	C HEX	L	FLOW DIA. D
222P-2-2	1/8	1/8	9/16	.88	.220
222P-4-2	1/4	1/8	3/4	1.06	.220
222P-4-4	1/4	1/4	3/4	1.25	.314
222P-6-2	3/8	1/8	7/8	1.10	.220
222P-6-4	3/8	1/4	7/8	1.25	.314
222P-6-6	3/8	3/8	7/8	1.25	.440
222P-8-4	1/2	1/4	1	1.47	.314
222P-8-6	1/2	3/8	1-1/16	1.47	.440
222P-8-8	1/2	1/2	1-1/16	1.66	.564
222P-12-6	3/4	3/8	1-3/8	1.50	.440
222P-12-8	3/4	1/2	1-3/8	1.69	.564
222P-12-12	3/4	3/4	1-3/8	1.69	.752

Hex-Head Plug 218P

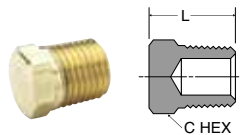

PART NO.	PIPE THREAD	C HEX	L
218P-2	1/8	7/16	.560
218P-4	1/4	9/16	.747
218P-6	3/8	11/16	.780
218P-8	1/2	7/8	.970
218P-12	3/4	1-1/16	1.054

Countersunk Hex-Head Plug 219P

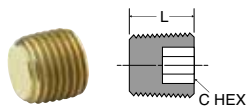

PART NO.	PIPE THREAD	C HEX	L
219P-2	1/8	3/16	.30
219P-4	1/4	1/4	.46
219P-6	3/8	5/16	.46
219P-8	1/2	3/8	.61
219P-12	3/4	9/16	.62

90° Union Elbow 1200P-2200P

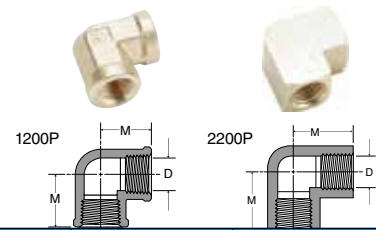

PART NO.	PIPE THREAD	M	FLOW DIA. D
1200P-2-2	1/8	.56	.329
2200P-2-2	1/8	.55	.339
1200P-4-4	1/4	.81	.441
2200P-4-4	1/4	.78	.441
1200P-6-6	3/8	.84	.571
2200P-6-6	3/8	.84	.571
2200P-8-8	1/2	1.07	.703

Click here for CADs, Product Specifications or to Configure Parts Online

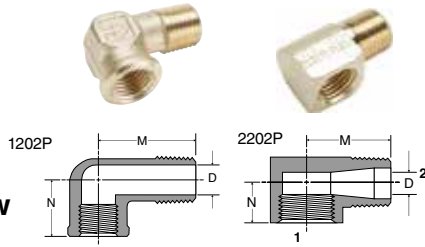

**90° Street Elbow
1202P-2202P**

PART NO.	1 PIPE THREAD	2 PIPE THREAD	M	N	FLOW DIA. D
1202P-2-2	1/8	1/8	.81	.56	.22
2202P-2-2	1/8	1/8	.62	.48	.22
2202PA-2-2*	1/8	1/8	.66	.48	.22
2202P-4-2	1/4	1/8	.72	.45	.23
1202P-4-4	1/4	1/4	1.08	.69	.31
2202P-4-4	1/4	1/4	.91	.45	.34
2202PA-4-4*	1/4	1/4	.91	.72	.31
2202P-4-6	1/4	3/8	.97	.78	.43
1202P-6-4	3/8	1/4	1.25	.78	.31
1202P-6-6	3/8	3/8	1.25	.78	.42
2202P-6-6	3/8	3/8	.98	.54	.41
2202PA-6-6*	3/8	3/8	.97	.78	.43
1202P-6-8	3/8	1/2	1.53	1.01	.56
1202P-8-6	1/2	3/8	1.25	.97	.42
2202P-8-8	1/2	1/2	1.25	1.03	.56
2202P-12-8	3/4	1/2	1.39	1.10	.56
2202P-12-12	3/4	3/4	1.39	1.10	.75

*Meets SAE Dimensions

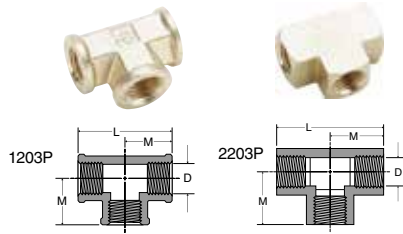

**Union Tee
1203P-2203P**

PART NO.	PIPE THREAD	L	M	FLOW DIA. D
1203P-2	1/8	1.12	.56	.339
2203P-2	1/8	1.06	.53	.339
1203P-4	1/4	1.38	.69	.441
2203P-4	1/4	1.52	.76	.441
2203P-6	3/8	1.68	.84	.571
1203P-8	1/2	2.14	1.07	.703
2203P-8	1/2	2.14	1.07	.703
2203P-12	3/4	2.28	1.14	.906

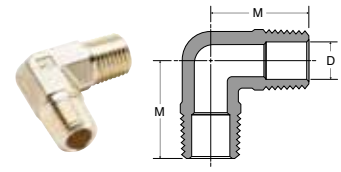

Male Elbow 1204P

PART NO.	PIPE THREAD	M	FLOW DIA. D
1204P-2	1/8	.71	.220
1204P-4	1/4	1.09	.312
1204P-6	3/8	1.09	.408
1204P-8	1/2	1.41	.502

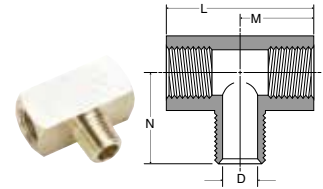

Male Branch Tee 2224P

PART NO.	PIPE THREAD	L	M	N	FLOW DIA. D
2224P-2	1/8	1.06	.53	.66	.220
2224P-4	1/4	1.52	.76	.91	.314
2224P-6	3/8	1.68	.84	.97	.440
2224P-8	1/2	2.18	1.09	1.25	.564
2224P-12	3/4	2.32	1.16	1.38	.752

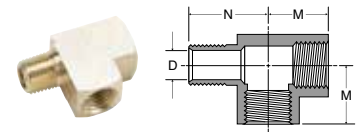

Street Tee 2225P

PART NO.	PIPE THREAD	M	N	DIA. D
2225P-2	1/8	.53	.66	.220
2225P-4	1/4	.76	.91	.314
2225P-6	3/8	.84	.98	.440
2225P-8	1/2	1.07	1.26	.564
2225P-12	3/4	1.14	1.38	.752

[Click here for CADs, Product Specifications or to Configure Parts Online](#)

**Drop-ear 90° Elbow
2200PDE**

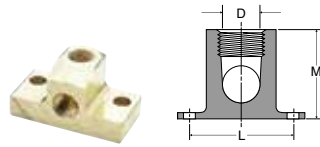

PART NO.	PIPE THREAD	L	M	FLOW DIA. D
2200PDE-2	1/8	1.38	1.00	.339

**45° Female Elbow
1201P-2201P**

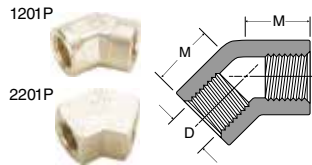

PART NO.	PIPE THREAD	M	FLOW DIA. D
2201P-2-2	1/8	.43	.339
1201P-8-8	1/2	.89	.703

Cross 2205P

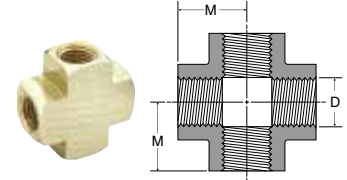

PART NO.	PIPE THREAD	M	FLOW DIA. D
2205P-2	1/8	.53	.339
2205P-4	1/4	.75	.441
2205P-6	3/8	.81	.571
2205P-8	1/2	1.07	.703
2205P-12	3/4	1.14	.906

**45° Street Elbow
2214P**

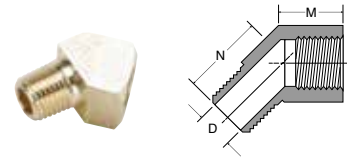

PART NO.	PIPE THREAD	M	N	FLOW DIA. D
2214P-2-2	1/8	.38	.50	.220
2214P-4-4	1/4	.54	.70	.314
2214P-6-6	3/8	.56	.78	.440
2214P-8-8	1/2	.73	1.00	.564
2214P-12-12	3/4	.75	1.35	.750

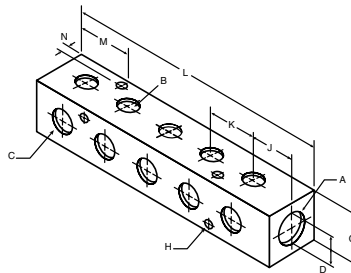

Brass Manifold 255M

PART NO.	PIPE THREAD A	PIPE THREAD B	PIPE THREAD C	G	MOUNTING HOLE DIA. H	J	K	L	M	N	D
255MP-6-4-2	3/8	1/8	1/4	1.25	.22	.88	1.13	6.25	1.45	.25	.25

Stainless Steel Adapters

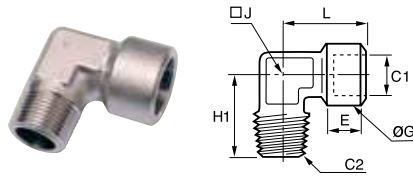

1844 Equal Male Stud Elbow Male BSPT to Female BSPP

PART NO.	C1 BSPT	C2 BSPP	E MM	G MM	H1 MM	J MM	L MM	WT KG
1844 10 10	R1/8	G1/8	7.5	15	20.5	10	22.5	.025
1844 13 13	R1/4	G1/4	12	18.5	27.5	12	26.5	.046
1844 17 17	R3/8	G3/8	12	23.5	28	14	30	.070
1844 21 21	R1/2	G1/2	15	28	38	18	38	.125
1844 27 27	R3/4	G3/4	16.5	33	41	22	44.5	.175
1844 34 34	R1	G1	19	40	48	32	50	.335

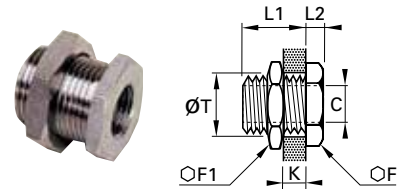

1871 Bulkhead Adapter NPT

PART NO.	C NPT	F MM	F1 MM	K MAX IN	L1 IN	L2 IN	T MIN IN	WT OZ
1871 00 11	1/8	19	22	.35	.55	.20	.65	1.33
1871 00 14	1/4	24	27	.67	.91	.20	.81	2.50
1871 00 18	3/8	30	32	.71	.91	.20	1.04	3.92
1871 00 22	1/2	32	36	.87	1.14	.24	1.12	4.98

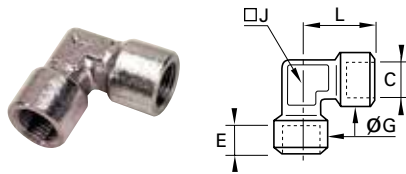

1843 Equal Elbow Female BSPP

PART NO.	C BSPP	E MM	G MM	J MM	L MM	WT KG
1843 10 10	G1/8	7.5	15	12	22.5	.044
1843 13 13	G1/4	11	18.5	15	26.5	.051
1843 17 17	G3/8	11.5	23.5	18	29	.077
1843 21 21	G1/2	15	28	23	38	.160
1843 27 27	G3/4	16.5	33	22	43.5	.232
1843 34 34	G1	19	40	32	52	.477

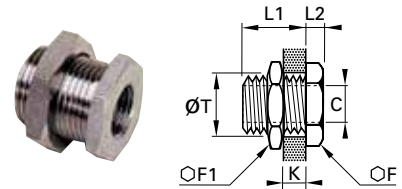

1817 Bulkhead Adapter BSPP

PART NO.	C BSPP	F MM	F1 MM	K MAX IN	L1 IN	L2 IN	T MIN IN	WT KG
1817 00 10	G1/8	19	22	9	14	4	16.5	.033
1817 00 13	G1/4	24	21	15	21	4	20.5	.057
1817 00 17	G3/8	30	32	14	21	5	26.5	.096
1817 00 21	G1/2	32	36	20	27	6	28.5	.117
1817 00 27	G3/4	41	41	22.5	30	6	34.5	.185
1817 00 34	G1	46	50	24.5	34	8	42.5	.306

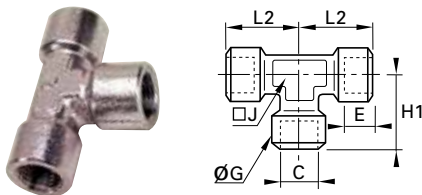

1845 Equal Tee Female BSPP

PART NO.	C BSPP	E MM	G MM	H1 MM	J MM	L2 MM	WT KG
1845 10 10	G1/8	7.5	15	22.5	12	22.5	.061
1845 13 13	G1/4	11	18.5	26.5	15	26.5	.074
1845 17 17	G3/8	11.5	23.5	29	18	29	.147
1845 21 21	G1/2	15	28	38	23	38	.224
1845 27 27	G3/4	16.5	33	43.5	22	43.5	.325
1845 34 34	G1	19	40	50	32	50	.489

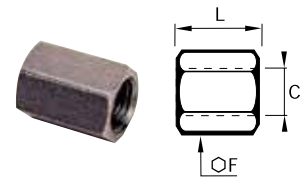

1855 Double Female Sleeve BSPP

PART NO.	C BSPP	F MM	L MM	WT KG
1855 10 10	G1/8	14	17	.033
1855 13 13	G1/4	17	24	.023
1855 17 17	G3/8	22	25	.042
1855 21 21	G1/2	27	32	.077
1855 27 27	G3/4	32	35	.116
1855 34 34	G1	41	40	.227

WARNING These products can expose you to chemicals including NICKEL or LEAD, which are known to the state of California to cause cancer.

[Click here for CADs, Product Specifications or to Configure Parts Online](#)

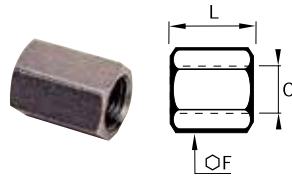

1870 Double Female Sleeve NPT

PART NO.	C NPT	F IN	L IN	WT OZ
1870 11 11	1/8	.55	.74	.564
1870 14 14	1/4	.67	1.10	1.164
1870 18 18	3/8	.87	1.10	1.940
1870 22 22	1/2	1.06	1.38	3.668

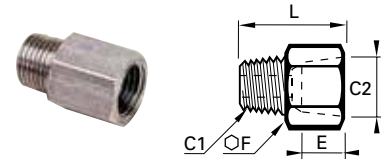

1867 Adapter Male BSPT to Female NPT

PART NO.	C1 BSPT	C2 NPT	E MM	F MM	L MM	WT KG
1867 10 11	R1/8	1/8	8	14	21	.014
1867 13 14	R1/4	1/4	11.5	17	28.5	.027
1867 18 18	R3/8	3/8	12	22	29.5	.044
1867 21 22	R1/2	1/2	15.5	27	37.5	.080

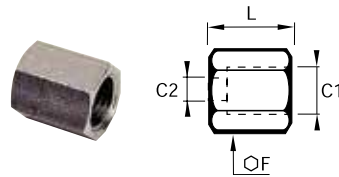

1862 Reducer/Expander Double Female Sleeve, BSPP

PART NO.	C1 BSPP	C2 BSPP	F MM	L MM	WT KG
1862 13 10	G1/4	G1/8	17	20.5	.023
1862 17 10	G3/8	G1/8	22	21	.042
1862 17 13	G3/8	G1/4	22	24.5	.048
1862 21 13	G1/2	G1/4	27	28.5	.084
1862 21 17	G1/2	G3/8	27	29	.080
1862 27 21	G3/4	G1/2	32	39.5	.160
1862 34 27	G1	G3/4	41	45	.302

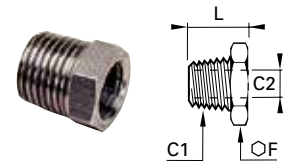

1872 Reducer Male/Female NPT

PART NO.	C1 NPT	C2 NPT	F MM	L MM	WT OZ
1872 14 11	1/4	1/8	14	.63	.42
1872 18 11	3/8	1/8	19	.65	.92
1872 18 14	3/8	1/4	19	.65	.71
1872 22 14	1/2	1/4	22	.83	1.59
1872 22 18	1/2	3/8	22	.83	1.24

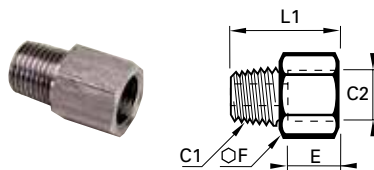

1864 Adapter Male NPT to Female BSPP

PART NO.	C1 NPT	C2 BSPP	E MM	F MM	L MM	WT KG
1864 11 10	1/8	G1/8	7.5	14	21.5	.014
1864 14 13	1/4	G1/4	11	17	30	.027
1864 18 17	3/8	G3/8	11.5	22	31	.043
1864 22 21	1/2	G1/2	15	27	39.5	.079

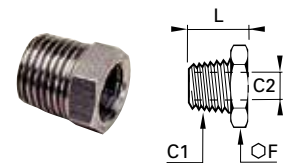

1863 Reducer Male BSPT to Female BSPP

PART NO.	C1 BSPT	C2 BSPP	F MM	L MM	WT KG
1863 13 10	R1/4	G1/8	14	16	.008
1863 17 10	R3/8	G1/8	17	16.5	.018
1863 17 13	R3/8	G1/4	17	16.5	.011
1863 21 13	R1/2	G1/4	22	21	.035
1863 21 17	R1/2	G3/8	22	21	.022
1863 27 21	R3/4	G1/2	27	25.5	.058
1863 34 27	R1	G3/4	36	28.5	.104

WARNING These products can expose you to chemicals including NICKEL or LEAD, which are known to the state of California to cause cancer.

[Click here for CADs, Product Specifications or to Configure Parts Online](#)

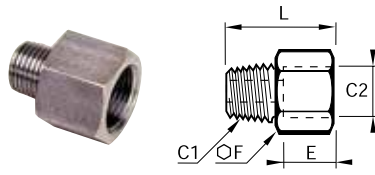

1873 Expander Male/Female NPT

PART NO.	C1 NPT	C2 NPT	E IN	F MM	L IN	WT OZ
1873 11 14	1/8	1/4	.55	14	.98	.092
1873 11 18	1/8	3/8	.55	22	.98	1.48
1873 14 18	1/4	3/8	.55	22	1.10	1.66
1873 14 22	1/4	1/2	.69	27	1.22	2.50
1873 18 22	3/8	1/2	.69	27	1.24	2.54

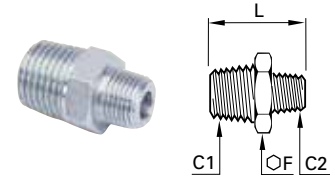

1821 Adapter Male BSPT

PART NO.	C1 BSPT	C2 BSPT	F MM	L MM	WT KG
1821 10 10	R1/8	R1/8	12	19	.008
1821 13 13	R1/4	R1/4	14	27	.019
1821 13 10	R1/4	R1/8	14	23.5	.015
1821 17 17	R3/8	R3/8	17	28	.025
1821 17 13	R3/8	R1/4	17	27.5	.024
1821 21 21	R1/2	R1/2	22	36	.048
1821 21 17	R1/2	R3/8	22	32.5	.041
1821 27 27	R3/4	R3/4	27	42	.099
1821 27 21	R3/4	R1/2	27	41	.088
1821 34 34	R1	R1	36	46	.168
1821 34 27	R1	R3/4	22	48	.158

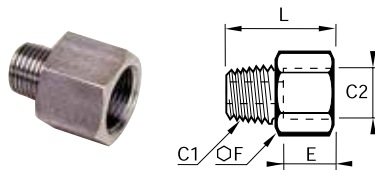

1861 Expander Male BSPT to Female BSPP

PART NO.	C1 BSPT	C2 BSPP	E MM	F MM	L MM	WT KG
1861 10 13	R1/8	G1/4	11	17	24	.021
1861 10 17	R1/8	G3/8	11.5	22	25	.037
1861 13 17	R1/4	G3/8	11.5	22	28.5	.041
1861 13 21	R1/4	G1/2	15	27	32.5	.069
1861 17 21	R3/8	G3/4	15	27	33	.070
1861 21 27	R1/2	G3/4	16.5	32	38	.104
1861 27 34	R3/4	G1	19	41	43.5	.200

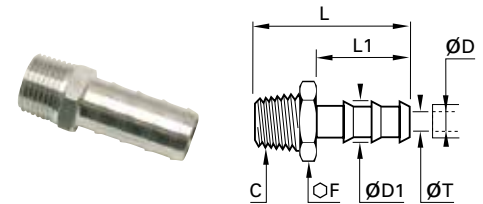

1823 Tailpiece Adapter For Rubber Hose Male NPT

PART NO.	ØD IN	C NPT	ØD1 IN	F MM	L IN	L1 IN	T MIN MM	WT OZ
1823 56 11	1/4	1/8	.33	10	1.34	.88	.21	.388
1823 56 14	1/4	1/4	.33	14	1.51	.88	.21	.635
1823 60 14	3/8	1/4	.46	14	1.51	.88	.33	.705
1823 60 18	3/8	3/8	.46	19	1.53	.88	.33	1.022

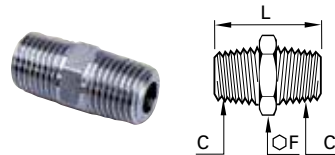

1821 Adapter Male NPT

PART NO.	C NPT	F MM	L MM	WT OZ
1821 11 11	1/8	12	.90	.388
1821 14 14	1/4	14	1.26	.811
1821 18 28	3/8	19	1.30	1.093
1821 22 22	1/2	22	1.65	1.975
1821 28 28	3/4	27	1.57	3.386
1821 35 35	1	36	1.81	5.679

WARNING These products can expose you to chemicals including NICKEL or LEAD, which are known to the state of California to cause cancer.

Metric Adapters



Parker's Metric Adapters offers a comprehensive range of NPT, BSPT, BSPP and metric pipe threads. Metric adapters are produced in both forgings and extrusions.

Product Features:

- All brass construction
- Nickel plated adapters
- Robust design
- Reusable

Markets:

- Industrial
- Construction
- Heavy duty truck
- Mobile
- Factory/process automation

Applications:

- Air Lines
- Water Line
- Cooling Lines

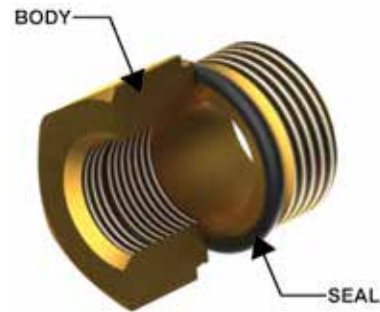

Specifications:

	Pressure Range	Temperature Range
Brass	1000 PSI (68.9 bar)	-40° to +302° F (-40° to +150° C)
Nickel-plated	870 PSI (59.9 bar)	-4° to +176° F (-20° to +80° C)

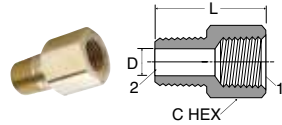

F3HG Adapter NPTF Male BSPT

PART NO.	NPTF 1	BSPT 2	C HEX	L	FLOW D
1/8F3HG-B	1/8	1/8	9/16	.93	.22
1/4F3HG-B	1/4	1/4	3/4	1.35	.31
3/8F3HG-B	3/8	3/8	7/8	1.35	.44
1/2F3HG-B	1/2	1/2	1-1/16	1.76	.56

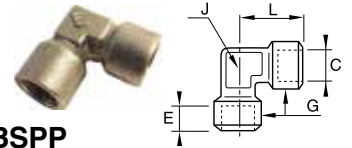

0143 90° Union Elbow BSPP

PART NO.	C BSPP	E MM	G MM	J MM	L MM	WT. KG
0143 10 10	G1/8	7.5	16.5	12	22.5	.042
0143 13 13	G1/4	11	18.5	15	26.5	.055
0143 17 17	G3/8	11.5	23.5	19	31.5	.098
0143 21 21	G1/2	15	28	23	35.5	.158
0143 27 27	G3/4	16.5	34	27	43.5	.256

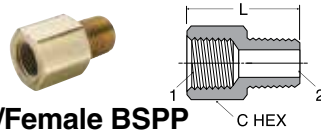

0164 Adapter Male NPT/Female BSPP

PART NO.	BSPP 1	NPTF 2	C HEX	L
0164 11 10	1/8	1/8	14	20
0164 14 13	1/4	1/4	17	27.5
0164 18 17	3/8	3/8	22	28.5
0164 22 21	1/2	1/2	27	36.5
0164 28 27	3/4	3/4	32	38.5

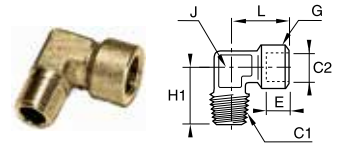

0144 Street Elbow Female BSPP to Male BSPT

PART NO.	C1 BSPT	C2 BSPP	E MM	G MM	H1 MM	J MM	L MM	WT. KG
0144 10 10	R1/8	G1/8	7.5	16.5	23	12	22.5	.033
0144 13 13	R1/4	G1/4	11	18.5	26	15	26.5	.050
0144 17 17	R3/8	G3/8	11.5	23.5	30	19	31.5	.085
0144 21 21	R1/2	G1/2	15	28	35	23	34.5	.138
0144 27 27	R3/4	G3/4	16.5	34	40	27	43.5	.229

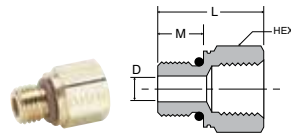

Pipe to Metric Adaptor 222P-X-MIX

PART NO.	NPTF	METRIC THREAD	HEX	L	M	D
222P-2-MI10	1/8-27	M10 X 1.0	9/16	.75	.34	.18
222P-2-MI14	1/8-27	M14 X 1.5	3/4	.91	.43	.30
222P-4-MI12	1/4-18	M12 X 1.5	11/16	1.09	.43	.24
222P-6-MI16	3/8-18	M16 X 1.5	7/8	1.10	.45	.35
222P-6-MI22	3/8-18	M22 X 1.5	1 1/16	1.05	.37	.47
222P-8-MI27	1/2-14	M27 X 2.0	1 1/4	1.32	.63	.60

Note: Fluorocarbon o-ring is standard

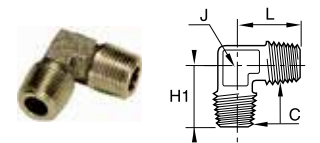

0152 Union Elbow Male BSPT

PART NO.	C BSPT	H1 MM	J MM	L MM	WT. KG
0152 10 10	R1/8	19.5	10	19.5	.018
0152 13 13	R1/4	25	15	25	.045
0152 17 17	R3/8	26.5	15	26.5	.056
0152 21 21	R1/2	31.5	19	31.5	.087
0152 27 27	R3/4	35.5	23	35.5	.153

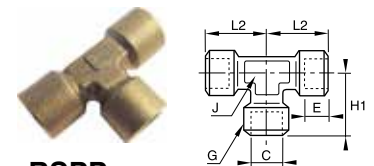

0145 Female Union Tee BSPP

PART NO.	C BSPP	E MM	G MM	H1 MM	J MM	L2 MM	WT. KG
0145 10 10	G1/8	7.5	16.5	22.5	12	22.5	.051
0145 13 13	G1/4	11	18.5	26.5	15	26.5	.074
0145 17 17	G3/8	11.5	23.5	31	19	31	.147
0145 21 21	G1/2	15	28	38	23	38	.231
0145 27 27	G3/4	16.5	34	47.5	27	47.5	.381

[Click here for CADs, Product Specifications or to Configure Parts Online](#)

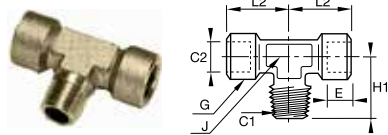

0158 Branch Tee Female BSPP to Male BSPT

PART NO.	C1 BSPT	C2 BSPP	E MM	G MM	H1 MM	J MM	L2 MM	WT. KG
0158 10 10	R1/8	G1/8	7.5	16.5	21.5	12	21.5	.045
0158 13 13	R1/4	G1/4	11	18.5	26	15	26	.071
0158 17 17	R3/8	G3/8	11.5	23.5	30	19	30	.118
0158 21 21	R1/2	G1/2	15	28	36	23	36	.203
0158 27 27	R3/4	G3/4	16.5	34	44	27	44	.320

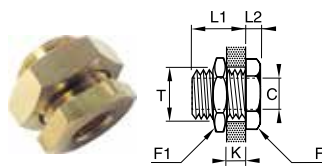

0117 Bulkhead BSPP and M5

PART NO.	C BSPP/M5	F MM	F1 MM	K MAX MM	L1 MM	L2 MM	T MAX MM	WT. KG
0117 00 19	M5X0.8	14	14	7	10.5	3.5	10.5	.013
0117 00 10	G1/8	19	22	9	14	4	16.5	.033
0117 00 13	G1/4	24	27	15	21	4	20.5	.057
0117 00 17	G3/8	30	32	14	21	5	26.5	.096
0117 00 21	G1/2	32	36	20	27	6	28.5	.117
0117 00 27	G3/4	41	41	22.5	30	6	34.5	.162
0117 00 34	G1	46	50	24.5	34	8	42.5	.270
0117 00 42	G1-1/4	55	55	29.5	39	8	49.5	.300
0117 00 49	G1-1/2	60	60	29.5	39	8	54.5	.306

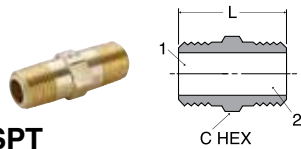

0121 Hex Nipple NPT/BSPT

PART NO.	NPTF 1	BSPT 2	C HEX	L
0121 11 10	1/8	1/8	11	19
0121 14 13	1/4	1/4	14	27
0121 18 17	3/8	3/8	17	28
0121 22 21	1/2	1/2	22	36
0121 28 27	3/4	3/4	27	40

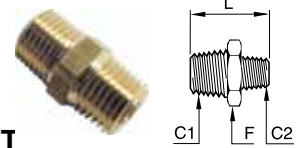

0121 Hex Nipple Male BSPT

PART NO.	C1 BSPT	C2 BSPT	F MM	L MM	WT. KG
0121 10 10	R1/8	R1/8	11	19	.009
0121 13 13	R1/4	R1/4	14	27	.021
0121 13 10	R1/4	R1/8	14	23.5	.021
0121 17 17	R3/8	R3/8	17	28	.025
0121 17 13	R3/8	R1/4	17	27.5	.024
0121 17 10	R3/8	R1/8	17	24	.022
0121 21 21	R1/2	R1/2	22	36	.053
0121 21 17	R1/2	R3/8	22	32.5	.045
0121 21 13	R1/2	R1/4	22	32	.045
0121 21 10	R1/2	R1/8	22	28.5	.041
0121 27 27	R3/4	R3/4	27	40	.092
0121 27 21	R3/4	R1/2	27	39	.084
0121 27 17	R3/4	R3/8	27	35.5	.076
0121 27 13	R3/4	R1/4	27	35	.079
0121 34 34	R1	R1	36	46	.156
0121 34 27	R1	R3/4	36	43	.143
0121 34 21	R1	R1/2	36	42	.133
0121 34 17	R1	R3/8	36	38.5	.126
0121 42 42	R1-1/4	R1-1/4	46	53	.233
0121 42 34	R1-1/4	R1	46	50.5	.237
0121 42 27	R1-1/4	R3/4	46	47.5	.229
0121 42 21	R1-1/4	R1/2	46	46.5	.219

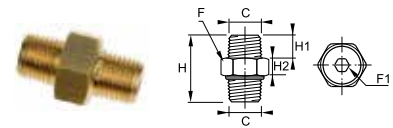

0929 3 Piece Adapter Double Male BSPT

PART NO.	C BSPT	F MM	F1 MM	H MM	H1 MM	H2 MM	WT. KG
0929 00 10	R1/8	15	5	27	9	8.5	0.181
0929 00 13	R1/4	19	6	33.5	11.5	9.5	0.100
0929 00 17	R3/8	22	8	36.5	13	10	0.010
0929 00 21	R1/2	27	12	45	15.5	12	0.088

Note: This connection accessory makes assembly easier thanks to its 3-piece design. To join the 2 threaded components, simply push together and tighten the nut.

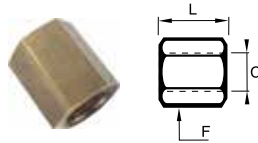

0155 Coupling BSPP

PART NO.	C BSPP	F MM	L MM	WT. KG
0155 10 10	G1/8	14	17	.015
0155 13 13	G1/4	17	24	.025
0155 17 17	G3/8	22	25	.045
0155 21 21	G1/2	27	32	.084
0155 27 27	G3/4	32	35	.109

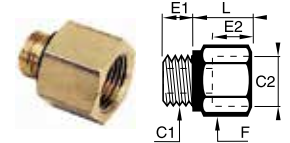

0169 Expander Female BSPP to Male BSPP

PART NO.	C1 BSPP	C2 BSPP	E1 MM	E2 MM	F MM	L MM	WT. KG
0169 10 13	G1/8	G1/4	5	11	17	16	.020
0169 10 17	G1/8	G3/8	5	14	22	19.5	.038
0169 13 17	G1/4	G3/8	7	14	22	19.5	.042
0169 13 21	G1/4	G1/2	7	14.5	27	20.5	.061
0169 17 21	G3/8	G1/2	8	14.5	27	20.5	.062
0169 17 27	G3/8	G3/4	8	15.5	32	22	.082
0169 21 27	G1/2	G3/4	9.5	15.5	32	22.5	.088

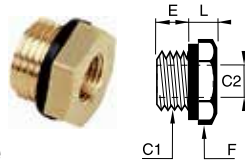

0168 Adapter Reducer Female BSPP to Male BSPP

PART NO.	C1 BSPP	C2 BSPP	E MM	F MM	L MM	WT. KG
0168 10 19	G1/8	M5X0.8	7	14	6	.008
0168 13 19	G1/4	M5X0.8	7	17	7	.010
0168 13 10	G1/4	G1/8	7	17	7	.010
0168 17 10	G3/8	G1/8	9	19	6	.020
0168 17 13	G3/8	G1/4	9	19	6	.013
0168 21 10	G1/2	G1/8	11	24	10	.046
0168 21 13	G1/2	G1/4	11	24	10	.038
0168 21 17	G1/2	G3/8	11	24	10	.026
0168 27 13	G3/4	G1/4	11	32	12	.090
0168 27 17	G3/4	G3/8	11	32	12	.078
0168 27 21	G3/4	G1/2	11	32	12	.058

* With captive polymer seal

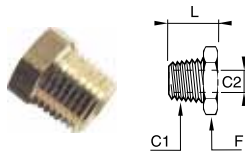

0163 Adapter Reducer Female BSPP to Male BSPT

PART NO.	C1 BSPT	C2 BSPP	F MM	L MM	WT. KG
0163 13 10	R1/4	G1/8	14	16	.009
0163 17 10	R3/8	G1/8	17	16.5	.020
0163 17 13	R3/8	G1/4	17	16.5	.012
0163 21 10	R1/2	G1/8	22	21	.047
0163 21 13	R1/2	G1/4	22	21	.038
0163 21 17	R1/2	G3/8	22	21	.025
0163 27 13	R3/4	G1/4	27	24	.086
0163 27 17	R3/4	G3/8	27	24	.069
0163 27 21	R3/4	G1/2	27	24	.048

Nickel Plated Metric Adapters

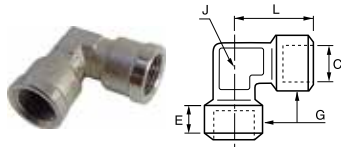

0912 Female Elbow BSPP and M5

PART NO.	C BSPP/M5	E MM	G MM	J MM	L MM	WT. KG
0912 00 19	M5	4	8	9	11	.037
0912 00 10	G1/8	8	13	10	21	.042
0912 00 13	G1/4	11	17	13	25.5	.055
0912 00 17	G3/8	11.5	21	17	28	.098
0912 00 21	G1/2	14	26	21	33.5	.158
0912 00 27	G3/4	15	31	27	36.5	.256

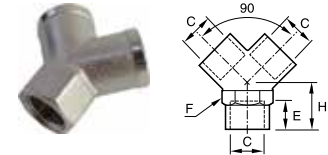

0910 "Y" Connector Female BSPP

PART NO.	C BSPP	E MM	F MM	H MM	WT. KG
0910 00 10	1/8	8	13	12	.055
0910 00 13	1/4	11	17	14	.081
0910 00 17	3/8	11.5	20	16	.128
0910 00 21	1/2	14	25	19	.213

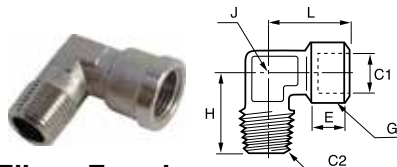

0913 / 0921 Street Elbow Female BSPP to Male BSPT and M5

PART NO.	C1 BSPP/M5	C2 BSPT	E MM	G MM	H MM	J MM	L MM	WT. KG
0921 00 19	M5		4	8	11	9	11	.037
0913 00 10	G1/8	R1/8	8	13	18.5	10	21	.033
0913 00 13	G1/4	R1/4	11	17	23.5	13	25.5	.050
0913 00 17	G3/8	R3/8	11.5	21	26	17	28	.085
0913 00 21	G1/2	R1/2	14	26	31	21	33.5	.138
0913 00 27	G3/4	R3/4	15	31	35	27	36.5	.229

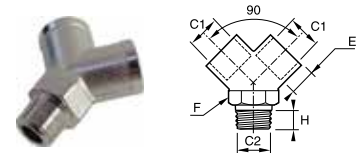

0911 "Y" Connector Female BSPP to Male BSPT

PART NO.	C1 BSPP	C2 BSPT	E	F	H	WT.
0911 00 10	G1/8	R1/8	8	13	12	.055
0911 00 13	G1/4	R1/4	11	17	14	.081
0911 00 17	G3/8	R3/8	11.5	20	16	.128
0911 00 21	G1/2	R1/2	14	25	19	.213

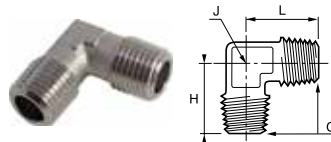

0914 / 0922 Equal Elbow Male BSPT or M5

PART NO.	C BSPT/M5	H MM	J MM	L MM	WT. KG
0922 00 19	M5	11	9	11	.037
0914 00 10	R1/8	18.5	10	18.5	.018
0914 00 13	R1/4	23.5	13	23.5	.045
0914 00 17	R3/8	26	17	26	.056
0914 00 21	R1/2	31	21	31	.087
0914 00 27	R3/4	35	27	35	.153

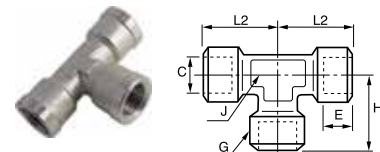

0915 Female Tee BSPP or M5

PART NO.	C BSPP/M5	E MM	G MM	H MM	J MM	L2 MM	WT. KG
0915 00 19	M5	4	8	11	9	11	.047
0915 00 10	G1/8	8	13	21	10	21	.051
0915 00 13	G1/4	11	17	25.5	13	25.5	.074
0915 00 17	G3/8	11.5	21	28	17	28	.147
0915 00 21	G1/2	14	26	33.5	21	33.5	.231
0915 00 27	G3/4	15	31	36.5	27	36.5	.381

Click here for CADs, Product Specifications or to Configure Parts Online

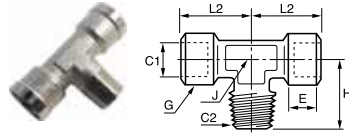

0916 / 0923 Branch Tee Female BSPP to Male BSPT

PART NO.	C1 BSPP/M5	C2 BSPT	E MM	G MM	H MM	J MM	L2 MM	WT. KG
0923 00 19	M5		4	8	11	9	11	.040
0916 00 10	G1/8	R1/8	8	13	18.5	10	21	.045
0916 00 13	G1/4	R1/4	11	17	23.5	13	25.5	.071
0916 00 17	G3/8	R3/8	11.5	21	26	17	28	.118
0916 00 21	G1/2	R1/2	14	26	31	21	33.5	.203
0916 00 27	G3/4	R3/4	15	31	36.5	27	36.5	.320

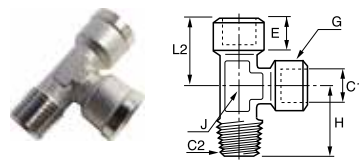

0917 / 0924 Run Tee Female BSPP to Male BSPT or M5

PART NO.	C1 BSPP/M5	C2 BSPT	E MM	G MM	H MM	J MM	L2 MM	WT. KG
0924 00 19	M5		4	8	11	9	11	.040
0917 00 10	G1/8	R1/8	8	13	18.5	10	21	.045
0917 00 13	G1/4	R1/4	11	17	23.5	13	25.5	.071
0917 00 17	G3/8	R3/8	11.5	21	26	17	28	.118
0917 00 21	G1/2	R1/2	14	26	31	21	33.5	.203
0917 00 27	G3/4	R3/4	15	31	36.5	27	36.5	.320

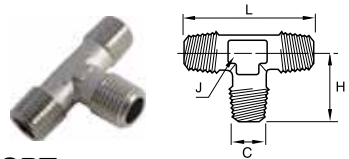

0927 Equal Male Tee BSPT

PART NO.	C BSPT	H MM	J MM	L MM	WT. KG
0927 00 10	R1/8	18.5	10	37	.017
0927 00 13	R1/4	23.5	13	47	.038
0927 00 17	R3/8	26	17	52	.057
0927 00 21	R1/2	31	21	62	.093

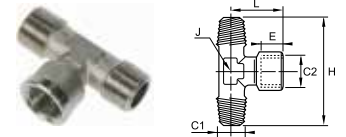

0928 Male Stud Branch Tee BSPT Female BSPP

PART NO.	C1 BSPT	C2 BSPP	E MM	H MM	J MM	L MM	WT. KG
0928 00 10	R1/8	G1/8	8	37	10	21	0.021
0928 00 13	R1/4	G1/4	11	47	13	25.5	0.044
0928 00 17	R3/8	G3/8	11.5	52	17	28	0.066
0928 00 21	R1/2	G1/2	14	62	21	33.5	0.109

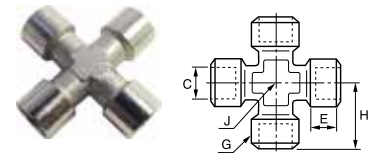

0908 Cross Female BSPP

PART NO.	C BSPP	E MM	G MM	H MM	J MM	WT. KG
0908 00 10	G1/8	8	13	21	10	.055
0908 00 13	G1/4	11	17	25.5	13	.081
0908 00 17	G3/8	11.5	21	28	17	.128
0908 00 21	G1/2	14	26	33.5	21	.213

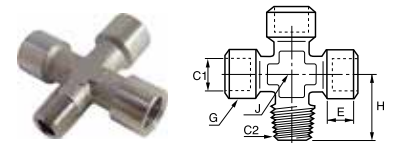

0909 Cross Female BSPP to Male BSPT

PART NO.	C1 BSPP	C2 BSPT	E MM	G MM	H MM	J MM	WT. KG
0909 00 10	G1/8	R1/8	8	13	18.5	10	.055
0909 00 13	G1/4	R1/4	11	17	23.5	13	.081
0909 00 17	G3/8	R3/8	11.5	21	26	17	.128
0909 00 21	G1/2	R1/2	14	26	31	21	.213

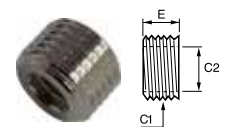

0903 Adapter Reducer BSPP

PART NO.	C1 BSPP	C2 BSPP	E MM	WT. KG
0903 10 13	G1/4	G1/8	8	.009
0903 13 17	G3/8	G1/4	9	.020
0903 17 21	G1/2	G3/8	10	.025
0903 21 27	G3/4	G1/2	14	.048
0903 27 34	G1"	G3/4	20	.060

[Click here for CADs, Product Specifications or to Configure Parts Online](#)

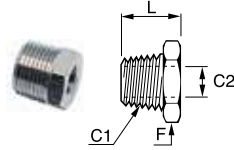

0904 Adapter Reducer Female BSPP to Male BSPT

PART NO.	C1 BSPT	C2 BSPP	F MM	L MM	WT. KG
0904 10 13	R1/4	G1/8	14	16	.009
0904 10 17	R3/8	G1/8	17	16.5	.020
0904 13 17	R3/8	G1/4	17	16.5	.012
0904 13 21	R1/2	G1/4	22	19.5	.038
0904 17 21	R1/2	G3/8	22	19.5	.025
0904 17 27	R3/4	G3/8	27	23.5	.069
0904 21 27	R3/4	G1/2	27	23.5	.048

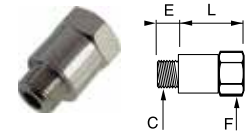

0907 Extended Adapter BSPP

PART NO.	C BSPP	E MM	F MM	L MM	WT. KG
0907 00 10	G1/8	6	14	16	.009
0907 00 10 01	G1/8	6	14	36	.009
0907 00 13	G1/4	8	17	23	.020
0907 00 13 01	G1/4	8	17	43	.020

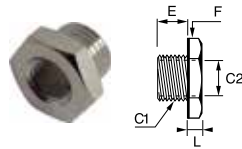

0905 Adapter Reducer Male BSPP to Female BSPP or M5

PART NO.	C1 BSPP	C2 BSPP M5	E MM	F MM	L MM	WT. KG
0905 19 10	G1/8	M5	6	14	4.5	.009
0905 10 13	G1/4	G1/8	8	17	5	.009
0905 10 17	G3/8	G1/8	9	19	5	.020
0905 13 17	G3/8	G1/4	9	19	5	.012
0905 13 21	G1/2	G1/4	10	24	5.5	.038
0905 17 21	G1/2	G3/8	10	24	5.5	.025
0905 17 27	G3/4	G3/8	12	30	5.5	.069
0905 21 27	G3/4	G1/2	12	30	5.5	.048

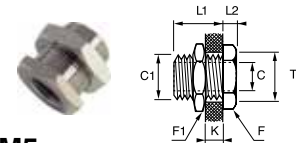

0920 Bulkhead BSPP and M5

PART NO.	C1 METRIC	C BSPP M5	F MM	F1 MM	K MAX MM	L1 MM	L2 MM	T MIN MM	WT. KG
0920 00 19	M10X1	M5	14	14	7	10.5	3.5	10.5	.013
0920 00 10	M16X1.5	G1/8	19	22	9	14	4	16.5	.033
0920 00 13	M20X1.5	G1/4	24	27	15	21	4	20.5	.057
0920 00 17	M26X1.5	G3/8	30	32	14	21	5	26.5	.096
0920 00 21	M28X1.5	G1/2	32	36	20	27	6	28.5	.117

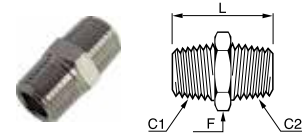

0900 Male Straight Adapter BSPT

PART NO.	C1 BSPT	C2 BSPT	F MM	L MM	WT. KG
0900 00 10	R1/8	R1/8	12	19.5	.009
0900 10 13	R1/8	R1/4	14	23.5	.021
0900 00 13	R1/4	R1/4	14	27	.021
0900 10 17	R1/8	R3/8	17	24	.022
0900 13 17	R1/4	R3/8	17	27.5	.024
0900 00 17	R3/8	R3/8	17	28	.025
0900 13 21	R1/4	R1/2	22	30.5	.045
0900 17 21	R3/8	R1/2	22	31	.045
0900 00 21	R1/2	R1/2	22	33.5	.055
0900 21 27	R1/2	R3/4	27	37.5	.084
0900 00 27	R3/4	R3/4	27	40	.092
0900 27 34	R3/4	R1	34	43	.143
0900 00 34	R1	R1	34	45.5	.156

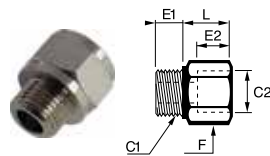

0906 Expander Female BSPP to Male BSPP

PART NO.	C1 BSPP/M5	C2 BSPP	E1 MM	E2 MM	F MM	L MM	WT. KG
0906 10 19	M5	G1/8	4	8	14	10	.009
0906 00 10	G1/8	G1/8	6	8.5	14	10	.009
0906 10 13	G1/8	G1/4	6	11.5	17	14	.020
0906 10 17	G1/8	G3/8	6	11.5	22	14.5	.038
0906 00 13	G1/4	G1/4	8	11.5	17	14	.040
0906 13 17	G1/4	G3/8	8	11.5	22	14.5	.042
0906 13 21	G1/4	G1/2	8	15	27	18	.061
0906 00 17	G3/8	G3/8	9	11.5	22	14.5	.061
0906 17 21	G3/8	G1/2	9	15	27	18	.062
0906 00 21	G1/2	G1/2	10	15	27	18	.070

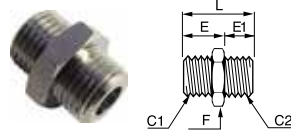

0901 Male Straight Adapter M5 or BSPP

PART NO.	C1 BSPP M5	C2 BSPP M5	E MM	E1 MM	F MM	L MM	WT. KG
0901 00 19	M5	M5	4	4	8	11.5	.002
0901 19 10	M5	G1/8	4	6	14	14.5	.008
0901 00 10	G1/8	G1/8	6	6	14	16.5	.008
0901 10 13	G1/8	G1/4	6	8	17	19	.014
0901 00 13	G1/4	G1/4	8	8	17	21	.016
0901 13 17	G1/4	G3/8	8	9	19	22	.021
0901 00 17	G3/8	G3/8	9	9	19	23	.024

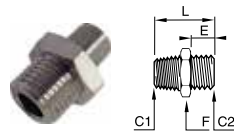

0192 Male Straight Adapter BSPT to BSPP

PART NO.	C1 BSPT	C2 BSPP	E MM	F MM	L MM	WT. KG
0192 10 13	R1/8	G1/4	9.5	17	23.5	.019
0192 13 13	R1/4	G1/4	9.5	17	27.5	.024
0192 13 21	R1/4	G1/2	27	27	31.5	.067
0192 17 13	R3/8	G1/4	9.5	17	45	.025
0192 17 21	R3/8	G1/2	27	27	31.5	.061
0192 21 21	R1/2	G1/2	27	27	34	.060

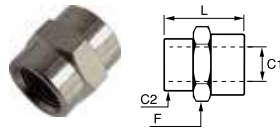

0902 Female Sleeve BSPP and M5

PART NO.	C1 BSPP/M5	C2 BSPP/M5	F MM	L MM	WT. KG
0902 00 19	M5	M5	8	11	.009
0902 19 10	M5	G1/8	14	13	.009
0902 00 10	G1/8	G1/8	14	15	.015
0902 10 13	G1/8	G1/4	17	19.5	.020
0902 00 13	G1/4	G1/4	17	22	.025
0902 10 17	G1/8	G3/8	22	20	.030
0902 13 17	G1/4	G3/8	22	23	.040
0902 00 17	G3/8	G3/8	22	24	.045
0902 13 21	G1/4	G1/2	27	27	.050
0902 17 21	G3/8	G1/2	27	27.5	.060
0902 00 21	G1/2	G1/2	27	30	.084
0902 21 27	G1/2	G3/4	30	30	.090
0902 00 27	G3/4	G3/4	30	32	.109



ISO Port Adapters

Parker's ISO Port Adapters meet dimensional requirements of ISO 6149-3.

Product Features:

- All brass construction
- Fluorocarbon O-ring
- NPTF, flare, hose barb, NTA end configurations

Markets:

- Industrial
- Construction
- Mobile
- Factory/process automation

Applications:

- Air Lines
- Water Line
- Cooling Lines

Specifications:

Pressure Range Dependent on tubing or hose end connection

Temperature Range Dependent on tubing or hose end connection

Pipe to Metric Adaptor 222P-X-MIX

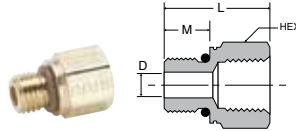

PART NO.	NPTF	METRIC THREAD	HEX	L	M	D
222P-2-MI10	1/8-27	M10 X 1.0	9/16	.75	.34	.18
222P-2-MI14	1/8-27	M14 X 1.5	3/4	.91	.43	.30
222P-4-MI12	1/4-18	M12 X 1.5	11/16	1.09	.43	.24
222P-4-MI14	1/4-18	M14 X 1.5	3/4	1.09	.43	.30
222P-6-MI16	3/8-18	M16 X 1.5	7/8	1.16	.45	.35
222P-6-MI22	3/8-18	M22 X 1.5	1 1/16	1.05	.51	.47
222P-8-MI27	1/2-14	M27 X 2.0	1 1/4	1.32	.63	.60

Note: Fluorocarbon o-ring is standard
For working pressure and Temperature see Metric Adapters Section

Flare to Metric Adaptor 48F-X-MIX

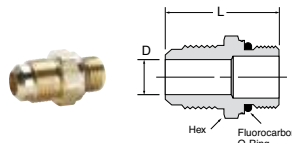

PART NO.	TUBE SIZE	METRIC THREAD	HEX	L	D
48F-8-MI16	1/2	M16 X 1.5	7/8	1.60	.35
48F-10-MI27	5/8	M27 X 2.0	1 1/4	1.87	.50
48F-12-MI27	3/4	M27 X 2.0	1 1/4	1.99	.63

Note: Fluorocarbon o-ring is standard
For working pressure and Temperature see SAE Flare Section

Flare Elbow to Metric Adaptor 149F-X-MIX

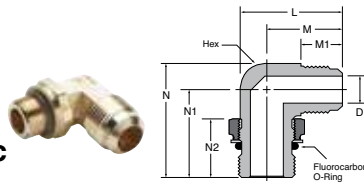

PART NO.	TUBE SIZE	METRIC THREAD	HEX	L	M	M1	N	N1	N2	D
149F-10-MI27	5/8	M27 X 2.0	7/8	1.95	1.46	.88	2.12	1.63	1.09	.50

Note: Fluorocarbon o-ring is standard
For working pressure and Temperature see SAE Flare Section

45° Flare Elbow to Metric Adaptor 159F-X-MIX

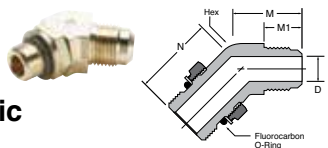

PART NO.	TUBE SIZE	METRIC THREAD	HEX	M	M1	N	D
159F-8-MI16	1/2	M16 X 1.5	13/16	1.10	.75	1.16	.36
159F-10-MI27	5/8	M27 X 2.0	1 1/8	1.21	.88	1.50	.50

Note: Fluorocarbon o-ring is standard
For working pressure and Temperature see SAE Flare Section

Hose Barb to Metric Adaptor 68HB-X-MIX

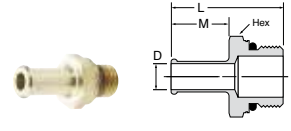

PART NO.	TUBE SIZE	METRIC THREAD	HEX	L	M	D
68HB-6-MI12	3/8	M12 X 1.5	11/16	1.50	.78	.24
68HB-6-MI14	3/8	M14 1.5	3/4	1.51	.78	.30
68HB-8-MI12	1/2	M12 X 1.5	11/16	1.50	.78	.24
68HB-10-MI27	5/8	M27 X 2.0	1 1/4	1.77	.78	.50

Note: Fluorocarbon o-ring is standard
For working pressure and Temperature see Hose Barb Section

Beaded Elbow to Metric Adaptor 169HB-X-MIX

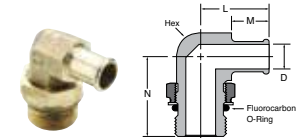

PART NO.	HOSE SIZE	METRIC THREAD	HEX	L	M	N	D
169HB-10-MI27	5/8	M27 X 2.0	7/8	1.41	.78	1.63	.50
169HB-16-MI27	1	M27 X 2.0	1	1.67	.97	1.68	.71

Note: Fluorocarbon o-ring is standard
For working pressure and Temperature see Hose Barb Section

NTA to Metric Adaptor 68NTA-X-MIX

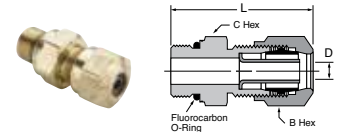

PART NO.	TUBE SIZE	METRIC THREAD	B HEX	C HEX	L	D
68NTA-4-MI10	1/4	M10 X 1.0	9/16	9/16	1.33	.140

Note: Fluorocarbon o-ring is standard
For working pressure and Temperature see Air Brake-NTA Section

Beaded Hose Barb 45° Elbow to Metric Thread 179HB-X-MIX

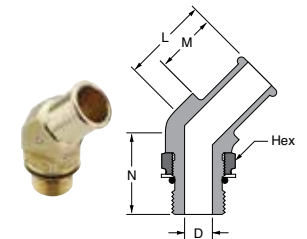

PART NO.	HOSE SIZE	METRIC THREAD	HEX	L	M	N	D
179HB-12-MI18	3/4	M18 X 1.5	13/16	1.15	.78	1.16	.44
179HB-16-MI27	1	M27 X 2.0	1 1/16	1.51	.97	1.71	.71

Note: Fluorocarbon o-ring is standard

Garden Hose Fittings



Parker's Garden Hose Fittings connect garden hose to other garden hose, to pipe or to tubing. Swivel connections allow hose to twist without kinking.

Product Features:

- All brass construction
- 3/4" garden hose thread
- Rubber washer
- Flare, hose barb and pipe end configurations
- High Flow couplings

Markets:

- Industrial
- Mobile
- Factory/process automation

Applications:

- Water Line

Specifications:

Pressure Range Up to 150 PSI (10.3 bar)

Temperature Range +35° to +100° F at 75 PSI
(+1.6° to +37.7° C at 5.1 bar)

Compatible Tubing:

- Garden Hose

Note: 90Gh is intended for use with the 97HC hose clamp or crimped ferrule. All female connector ends should have a rubber washer(901GH-12) inserted prior to use.

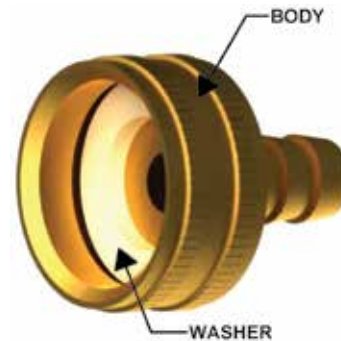

[Click here for CADs, Product Specifications or to Configure Parts Online](#)

Swivel Connector SAE Flare to Female Hose Thread 50GHSV

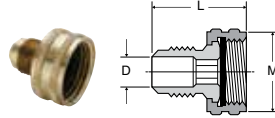

PART NO.	TUBE SIZE	HOSE THREAD	L	M	FLOW DIA. D
50GHSV-6-12	3/8	3/4	1.25	1.15	.297
50GHSV-8-12	1/2	3/4	1.34	1.15	.406

Female Hose to Male Pipe 82GH & 83GH

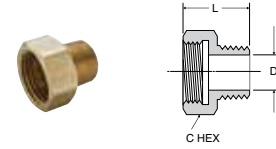

PART NO.	HOSE THREAD	PIPE THREAD	C HEX	L	FLOW DIA. D
82GH-12-8	3/4	1/2	1-3/16	1.20	.562
83GH-12-12	3/4	3/4	1-3/16	1.22	.750

Hose Barb to Male Hose Thread 53GH, 54GH & 55GH

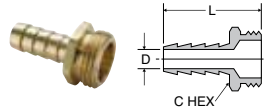

PART NO.	I.D. HOSE SIZE	HOSE THREAD	C HEX	L	FLOW DIA. D
53GH-8-12	1/2	3/4	1-1/16	1.88	.375
54GH-10-12	5/8	3/4	1-1/16	1.88	.500
55GH-12-12	3/4	3/4	1-1/16	1.88	.625

Swivel Connector Female Garden Hose to Male Pipe 88GH

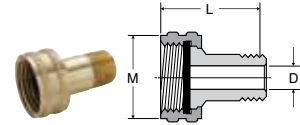

PART NO.	HOSE THREAD	PIPE THREAD	L	M	FLOW DIA. D
88GH-12-4	3/4	1/4	1.69	1.15	.312
88GH-12-6	3/4	3/8	1.69	1.15	.406

Male Hose to Male Pipe 69GH, 70GH, 71GH

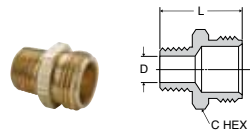

PART NO.	HOSE THREAD	PIPE THREAD	C HEX	L	FLOW DIA. D
69GH-12-4	3/4	1/4	1-1/16	1.25	.410
69GH-12-6	3/4	3/8	1-1/16	1.25	.406
70GH-12-8	3/4	1/2	1-1/16	1.39	.531
71GH-12-12	3/4	3/4	1-1/16	1.41	.750

Swivel Connector Female Garden Hose to Hose Barb 90GH

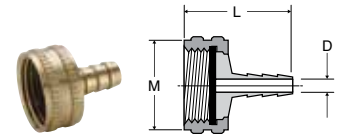

PART NO.	HOSE THREAD	I.D. HOSE SIZE	L	M	FLOW DIA. D
90GH-12-3	3/4	3/16	1.29	1.15	.125
90GH-12-4	3/4	1/4	1.21	1.15	.187
90GH-12-6	3/4	3/8	1.21	1.15	.281
90GH-12-8	3/4	1/2	1.21	1.15	.375
90GH-12-10*	3/4	5/8	1.93	1.19	.500
90GH-12-12*	3/4	3/4	1.93	1.19	.625

*Denotes hex body

Male Hose to Male Hose 75GH

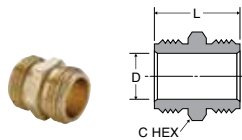

PART NO.	HOSE THREAD	C HEX	L	FLOW DIA. D
75GH-12	3/4	1-1/16	1.25	.750

Male Hose to Female Pipe 78GH, 79GH, 80GH & 81GH

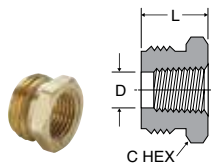

PART NO.	HOSE THREAD	PIPE THREAD	C HEX	L	FLOW DIA. D
78GH-12-4	3/4	1/4	1-1/16	.75	.422
79GH-12-6	3/4	3/8	1-1/16	.75	.562
80GH-12-8	3/4	1/2	1-1/16	.75	.687
81GH-12-12	3/4	3/4	1-3/16	1.28	.719

Knurled Hose Nut 94GH

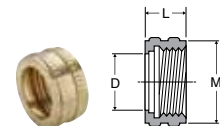

PART NO.	HOSE THREAD	L	M	FLOW DIA. D
94GH-12	3/4	.57	1.15	.808

WARNING These products can expose you to chemicals including CARBON BLACK or LEAD, which are known to the state of California to cause cancer.

[Click here for CADs, Product Specifications or to Configure Parts Online](#)

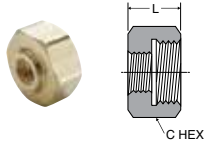

Hose Nut Reducer 95GH

PART NO.	HOSE THREAD	PIPE THREAD	C HEX	L
95GH-12-2	3/4	1/8	1-1/8	.63

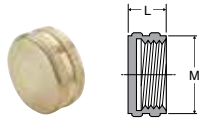

Hose Cap Nut 96GH

PART NO.	HOSE THREAD	L	M
96GH-12	3/4	.50	1.15

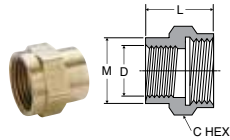

Female Hose to Female Pipe 98GH & 99GH

PART NO.	HOSE THREAD	PIPE THREAD	C HEX	L	M	FLOW DIA. D
98GH-12-8	3/4	1/2	1-3/16	1.14	1.01	.687
99GH-12-12	3/4	3/4	1-3/16	1.25	1.17	.750

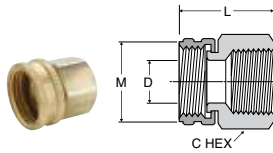

Swivel Connector Female Hose to Female Pipe 98GHSV & 99GHSV

PART NO.	HOSE THREAD	PIPE THREAD	C HEX	L	M	FLOW DIA. D
98GHSV-12-8	3/4	1/2	1	1.27	1.21	.687
99GHSV-12-12	3/4	3/4	1-3/16	1.34	1.21	.687

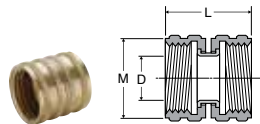

Swivel Nut Connector 101GHSV

PART NO.	HOSE THREAD	L	M	FLOW DIA. D
101GHSV-12	3/4	1.25	1.15	.625



Rubber Garden Hose Coupling Washer 901GH

PART NO.	HOSE THREAD
901GH-12	3/4

NOTE: All female connector ends should have this rubber washer

Hydraulic Quick Couplings/ High Flow Couplings

Applications

Parker Water Service Couplings are used anywhere water hoses are connected and disconnected frequently. They are used on a wide variety of applications including garden hoses, wash down systems, and mobile water tank lines. The unvalved design permits maximum flow with minimum pressure drop.

Features

- Brass and stainless steel construction for heavy duty service.
- Durable 4-ball locking mechanism for secure connections.
- Quality, temperature-resistant nitrile seals for a leak-free service life.

Specifications

- Body Size 3/4"
- Rated Pressure PSI 200 (13.7 bar)
- Rated Flow GPM 28
- Temperature Range (std seals) -40° to +250° F (-40° to 121.1° C)

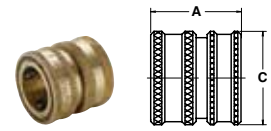

High Flow Coupler 1163-60-BPD

PART NO.	BODY SIZE	THREAD SIZE NH	A	C
1163-60-BPD	3/4	3/4-11 1/2	1.12	1.21

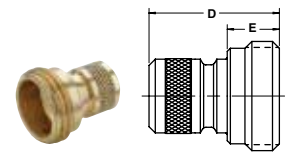

High Flow Nipple 1163-61-BPD

PART NO.	BODY SIZE	THREAD SIZE NH	D	E
1163-61-BPD	3/4	3/4-11 1/2	1.25	.5

WARNING These products can expose you to chemicals including CARBON BLACK or LEAD, which are known to the state of California to cause cancer.



Quick-Acting Couplers

Nylon Safety C9000

Industrial Interchange Coupler



GOODYEAR
RUBBER PRODUCTS, INC.

☎ 727-342-5088

You can also email us at
GRP@goodyearrubberproducts.com

C9000 Nylon Quick-Acting Safety Couplers



Parker Legris' C9000 nylon quick-acting safety couplers have been designed for the safety of operators and machinery while giving very high energy efficiency performance. Available in three profile standards, it is perfectly suited for any type of installation.

Product Features:

Safety & Reliability

- Prevents risk of whiplash
- Quick-acting vent allowing disconnection to be carried out in total safety
- Rotating sleeve to avoid risk of accidental disconnection
- Nylon sleeve protects equipment from scratching
- Protective spiral over the tube prevents kinking

Performance

- Very high flow and low pressure drop
- 100% leak-tested in production
- Date coding to guarantee quality and traceability
- Robust impact-resistant material
- Optimum energy efficiency
- Long-term reliability
- Silicone-Free

Easy-to-Use

- Immediate identification by clear marking on each model showing:
 - profile of the compatible male probe
 - type part number
- Compatible with male probes conforming to:
 - ISO B profile
 - European profile
 - ARO profile

Specifications:

Compatible Fluids	Compressed air only
Working Pressure	Up to 230 psi (16 bar)
Working Temperature	-4° to 140° F (20° to 60° C)

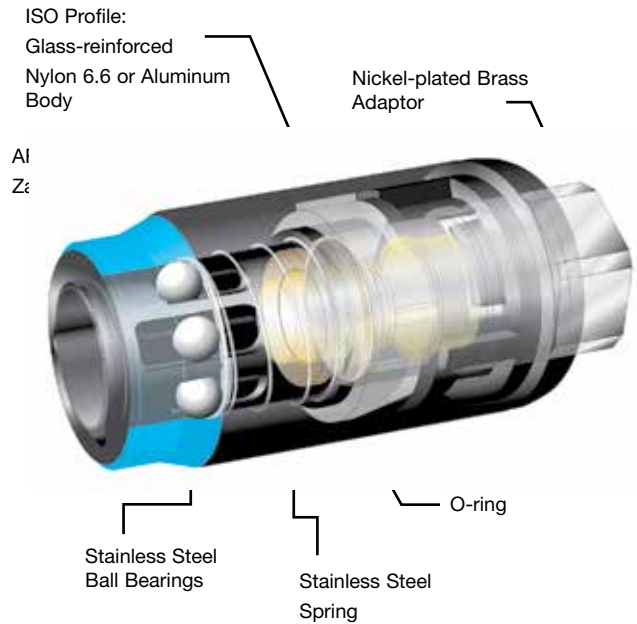

Markets:

- Water Filtration
- Beverage Dispensing
- Life Science
- Bottling
- Semi-Conductor

Applications:

- Workshops
- Cleaning
- Blowing
- Pneumatics
- Air-Operated Tools
- Ring Main Circuits
- Packaging

C9000 Technology and Flow Rates

“Typical” Quick-Acting Coupler
Standard “poppet” technology
Flow: 1400 NI/min

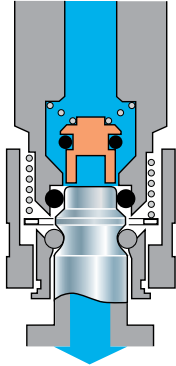

C9000 Quick-Acting Coupler
“Optimal flow” technology
Flow: 2400 NI/min

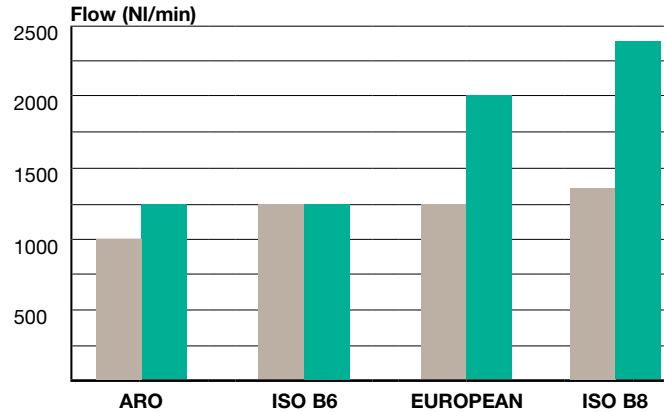
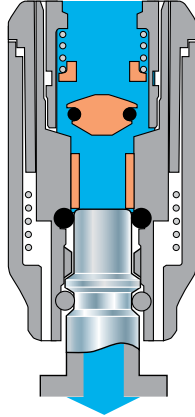

C9000 Coupler
Standard Couplers

Measurements carried out in accordance with ISO 6358 at a pressure of 6 bar, pressure drop < 0.7 bar

Operation

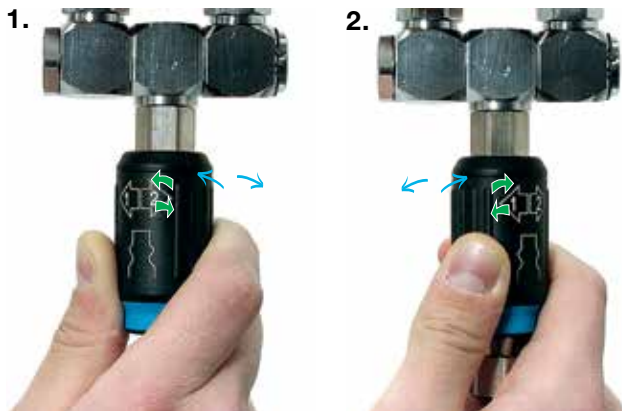

Connecting the probe

The sleeve does not need to be rotated to connect the probe.

Disconnecting the probe

Rotation, arrow 1: circuit vented on probe side.
Rotation, arrow 2: probe disconnected from the body.

Venting Time



ISO B6 profile, recoil tubing (I.D. 6 mm, length 6 m)

Venting time = 350 ms (transition from 6 bar to 0.2 bar)

ISO B8 profile, PVC tubing (I.D. 10 mm, length 25 m)

Venting time = 860 ms (transition from 6 bar to 0.2 bar)

Even with longer lengths of tubing, the vent time of the C9000 coupler can be less than 1 second.

C9000 Safety Couplers – Industrial Interchange

9405U
NPT
p. G7-G8



9415U
NPT
p. G7-G8



9410U
p. G7-G8



9417U
NPT
p. G7-G8



9421U
p. G7-G8



9442U
NPT
p. G7-G8



9084
NPT
p. G7-G8



9083
NPT
p. G7-G8



9085
p. G7-G8



9080U
p. G7-G8



C9000 Safety Couplers – ARO 210

9405A
NPT
p. G9



9415A
NPT
p. G9



9410A
p. G9



9421A
p. G9



9442A
NPT
p. G9



9084
NPT
p. G9



9083
NPT
p. G9



9085
p. G9



9080A
p. G9



Industrial Interchange Couplers

9L05
NPT
p. G11



9L04
NPT
p. G11



9L85
NPT
p. G11



9084
NPT
p. G11



9083
NPT
p. G11



9085
NPT
p. G11



Flow: 47 scfm

The C9000 Industrial Interchange 1/4 body size ensures a superior flow and total security due to disconnection in two steps. Therefore C9000 is perfectly suited for numerous type of installations:

- pneumatic tools
- blowguns
- pneumatic automotive equipment
- production cells

Industrial Interchange Profile: Body Size 1/4 I.D.

ISO 6150 B
NF.E49.053
US.MIL.C 4109
CEJN 310
Prevost IRC06.ISC06
Rectus 23.24

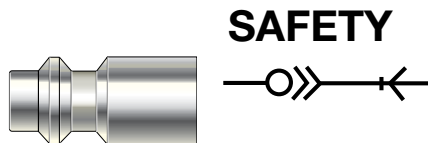

SAFETY

Couplers

9405U Male Straight Body NPT



PART NO.	NPT	W OZ
9405U06 14	1/4	1.6
9405U06 18	3/8	1.6
9405U06 22	1/2	2.0

9415U Female Straight Body NPT



PART NO.	NPT	W OZ
9415U06 14	1/4	1.6
9415U06 18	3/8	1.6
9415U06 22	1/2	2.0

9410U Body + Spring Guard



PART NO.	ØD	W OZ
9410U06 08	5/16	1.55

9417U Bulkhead Body NPT



PART NO.	NPT	W OZ
9417U06 14	1/4	2.0

9421U Barbed Connector Body



PART NO.	ØD	W OZ
9421U06 06	1/4, 6MM	1.6
9421U06 08	5/16, 8MM	1.6
9421U06 10	3/8, 10MM	1.6

9442U "Y" Connector Body



PART NO.	NPT	W OZ
9442U06 18	3/8	7.65

Plugs



9084 Male Straight NPT

PART NO.	NPT	W OZ
9084 23 14	1/4	1.01
9084 23 18	3/8	1.35



9083 Female Straight NPT

PART NO.	NPT	W OZ
9083 23 14	1/4	.95
9083 23 18	3/8	1.36



9085 Barbed Connector

PART NO.	ØD	W OZ
9085 23 56	1/4	.85
9085 23 08	5/16	.88
9085 23 60	3/8	.93



9080U Body + Spring Guard

PART NO.	ØD	W OZ
9080U06 08	5/16	1.03
9080U06 60	3/8	1.27

Flow Characteristics – 1/4 body size

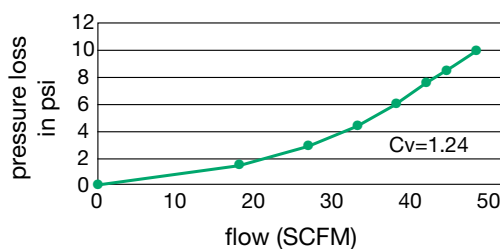

Working pressure
up to 230 psi (16 bar)

WARNING These products can expose you to chemicals including NICKEL, CARBON BLACK, TITANIUM DIOXIDE, or LEAD, which are known to the state of California to

Flow: 97 scfm

The C9000 Industrial Interchange 3/8 body size has a very high flow capacity. Its robust construction and the twist disconnect design make it perfectly suited for heavy duty applications such as:

- large pneumatic tools
- main supply outlets
- stamping equipment

Industrial Interchange Profile: Body Size 3/8 I.D.

ISO 6150 B
NF.E49.053
US.MIL.C 4109
CEJN 310
Prevost IRC08.ISC08
Rectus 30

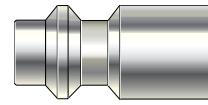

SAFETY



Couplers

9405U Male Straight Body NPT



PART NO.	NPT	W OZ
9405U08 14	1/4	3.2
9405U08 18	3/8	3.2
9405U08 22	1/2	4.0

9415U Female Straight Body NPT



PART NO.	NPT	W OZ
9415U08 14	1/4	3.2
9415U08 18	3/8	3.2
9415U08 22	1/2	4.0

9417U Bulkhead Body NPT



PART NO.	NPT	W OZ
9417U08 18	3/8	3.95

9421U Barbed Connector Body



PART NO.	NPT	W OZ
9421U08 06	1/4, 6MM	3.20
9421U08 08	5/16, 8MM	3.25
9421U08 10	3/8, 10MM	3.45
9421U08 13	1/2, 13MM	3.90

9442U "Y" Connector Body



PART NO.	NPT	W OZ
9442U08 22	1/2	10.95

Plugs

9084 Male Straight NPT



PART NO.	NPT	W OZ
9084 30 14	1/4	1.11
9084 30 18	3/8	1.35
9084 30 22	1/2	1.58

9083 Female Straight NPT



PART NO.	NPT	W OZ
9083 30 14	1/4	1.03
9083 30 18	3/8	1.44

9085 Barbed Connector



PART NO.	NPT	W OZ
9085 30 08	5/16	.94
9085 30 60	3/8	.96
9085 30 62	1/2	1.01

9080U Body + Spring Guard



PART NO.	NPT	W OZ
9080U06 62	1/2	1.87

Flow Characteristics – 3/8 body size

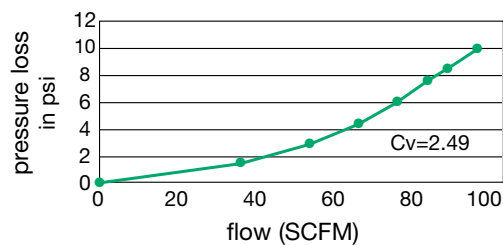

Working pressure
up to 230 psi (16 bar)

WARNING These products can expose you to chemicals including NICKEL, CARBON BLACK, TITANIUM DIOXIDE, or LEAD, which are known to the state of California to

Flow: 44 scfm

The C9000 ARO 210 profile 1/4 body sizes ensure the user a superior flow and small pressure pass - therefore they are perfectly suited for numerous types of installations and equipment.

ARO 210 Profile: Body Size 1/4 I.D.

ARO 210
CEJN300
Orion 44510
Parker 50
Rectus 14-22

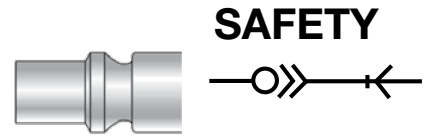

Couplers

9405A Male Straight Body NPT



PART NO.	NPT	W OZ
9405A06 14	1/4	1.6
9405A06 18	3/8	1.6

9415A Female Straight Body NPT



PART NO.	NPT	W OZ
9415A06 14	1/4	1.6

9410A Body + Spring Guard



PART NO.	ØD	W OZ
9410A06 08	5/16	1.55

9421A Barbed Connector Body



PART NO.	ØD	W OZ
9405A06 06	1/4, 6MM	1.6
9405A06 08	5/16, 8MM	1.6
9405A06 10	3/8, 10MM	1.6

9442A "Y" Connector Body



PART NO.	NPT	W OZ
9442A06 18	3/8	7.65

Plugs

9084 Male Straight NPT



PART NO.	NPT	W OZ
9084 22 14	1/4	1.01

9083 Female Straight NPT



PART NO.	NPT	W OZ
9083 22 14	1/4	.95

9085 Barbed Connector



PART NO.	ØD	W OZ
9085 22 06	1/4, 6MM	.494
9085 22 08	5/16, 8MM	.564
9085 22 10	3/8, 10MM	.635

9080A Body + Spring Guard



PART NO.	ØD	W OZ
9080A06 08	5/16, 8MM	1.83

OSHA Recommendation

Safety concerns regarding power tools

Pneumatic Tools – Disconnection

“Pneumatic tools must be checked to see that the tools are fastened securely to the air hose to prevent them from being disconnected. A short wire or positive locking device attaching the air hose to the tool must also be used and will serve as an added safeguard.”

WARNING These products can expose you to chemicals including NICKEL, CARBON BLACK, TITANIUM DIOXIDE, or LEAD, which are known to the state of California to

Features and Benefits:

- Conforms to ANSI (NFPA) T3.20.14-1990 and MIL-C-4109 specifications
- Type "A900" interchange
- More balanced connection (6 ball bearings instead of 4)
- Protective sleeve
- Automatic and easy connection
- Plug insertion force 4.6 lbF
- Interchange with major competitors
- Prolonged life
- Provides protection from accidental disconnection
- No leaks once connection is made

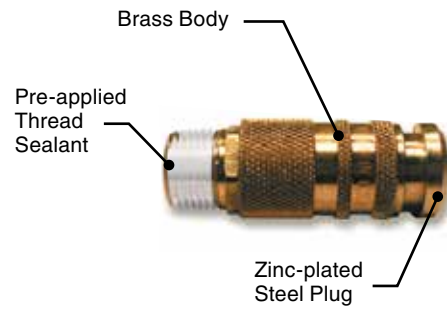

Markets:

- Automotive Process
- Construction
- General Industrial and Air Piping

Applications:

- Factory Automation
- Air Operated Tools
- Workshops
- Pneumatic Equipment
- Cleaning

Features and Benefits:

Interchanges with other manufacturers product conforming to ANSI (NFPA) T3.20.14-1990 and MIL-C-4109 specifications

Industrial Interchange Coupler Flow Rate

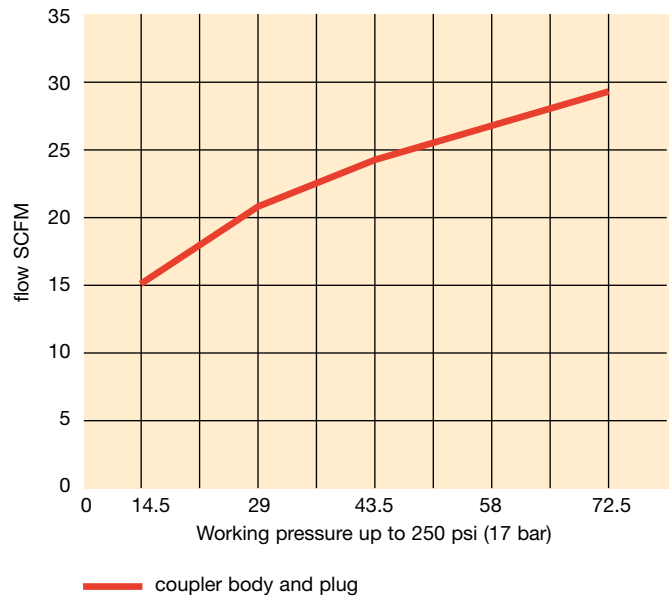

Technical Performances

Sealing Material	Nitrile (Buna-N) U-cup and O-ring
Max. Working Pressure	250 psi (17 bar)
Proof Pressure	4:1 Safety factor
Operating Temperature Range	-40° to 250° F (-40° to 121° C)
Vacuum Data	Disconnected, not recommended Connected, 28 in Hg
Direction of Flow	Connected, either direction Disconnected, seal only in one direction, air in
Thread Sealant	On male NPT threads

Used in compressed air applications
(Please consult us for additional fluids.)

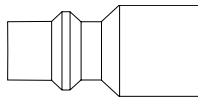

actual size

Body Size 1/4 I.D.

ISO 6150 B
AFNOR:
NF.E49.053
US.MIL.C 4109
CEJN 310
Prevost IRC06.ISC06
Rectus 23.24

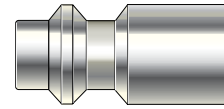

Can be interchanged with other manufacturers.

Couplers



9L05 Male Straight Body NPT

PART NO.	NPT	W OZ
9L05 11 14P180	1/4	3.03
9L05 11 18P180	3/8	3.09



9L04 Female Straight Body NPT

PART NO.	NPT	W OZ
9L04 11 14P180	1/4	2.94
9L04 11 18P180	3/8	1.33



9L85 Barbed Connector Body

PART NO.	HOSE ID	W OZ
9L85 11 14P1	1/4	3.03
9L85 11 18P1	3/8	3.10

Plugs



9084 Male Straight NPT

PART NO.	NPT	W OZ
9084 23 14	1/4	1.01
9084 23 18	3/8	1.35



9083 Female Straight NPT

PART NO.	NPT	W OZ
9083 23 14	1/4	.95
9083 23 18	3/8	1.36



9085 Barbed Connector

PART NO.	NPT	W OZ
9085 23 56	1/4	.81
9085 23 08	5/16	.88
9085 23 60	3/8	.93

Hose barb versions are to be used with single braid general purpose industrial grade rubber hose only. These versions are not to be used with nylon or polyurethane tubing. Hose should be clamped onto the barb with either a worm gear or double ear type clamp. Hose can also be crimped onto the hose barb with a crimped metal ferrule.

WARNING These products can expose you to chemicals including NICKEL, CARBON BLACK, TITANIUM DIOXIDE, or LEAD, which are known to the state of California to

C9000 Industrial Interchange Profile

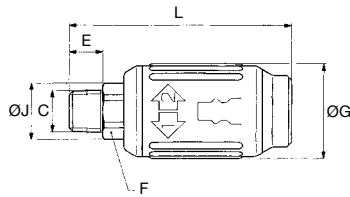

9405U Male Straight Body NPT – 1/4 I.D.

PART NO.	C NPT	E IN	F MM	ØG IN	ØJ IN	L MM
9405U06 14	1/4	.43	17	1.24	.73	2.91
9405U06 18	3/8	.45	19	1.24	.83	2.97
9405U06 22	1/2	.59	22	1.24	.95	3.17

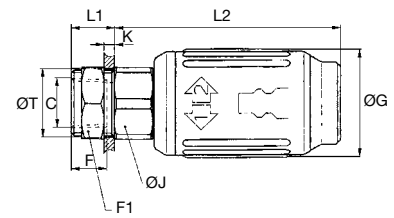

9417U Bulkhead Body NPT – 1/4 I.D.

PART NO.	C NPT	E IN	F MM	F1 MM	ØG IN	ØJ IN	K MAX IN	L1 IN	L2 IN	ØT MIN IN
9417U06 14	1/4	.47	22	22	1.24	.95	.24	.49	2.70	.73

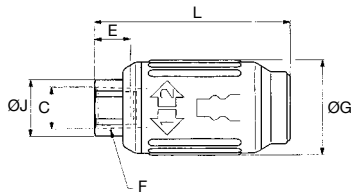

9415U Female Straight Body NPT – 1/4 I.D.

PART NO.	C NPT	E IN	F MM	ØG IN	ØJ IN	L MM
9415U06 14	1/4	.47	17	1.24	.73	2.58
9415U06 18	3/8	.47	22	1.24	.95	2.84
9415U06 22	1/2	.59	27	1.24	1.16	3.01

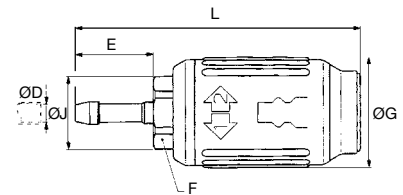

9421U Barbed Connector Body – 1/4 I.D.

PART NO.	C	E IN	F MM	ØG IN	ØJ IN	L MM
9421U06 06	1/4, 6MM	1.02	17	1.24	.73	3.48
9421U06 08	5/16, 8MM	1.02	17	1.24	.73	3.48
9421U06 10	3/8, 10MM	1.02	17	1.24	.73	3.48

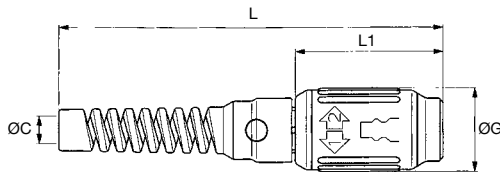

9410U Body + Spring Guard – 1/4 I.D.

PART NO.	C NPT	ØG IN	L IN	L1 MM
9410U06 08	5/16	31.5	145	56

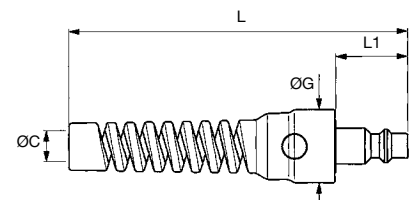

9080U Body + Spring Guard – 1/4 I.D.

PART NO.	C NPT	ØG IN	L IN	L1 MM
9080U06 08	5/16	24	112	24
9080U06 60	3/8	24	112	24

WARNING These products can expose you to chemicals including NICKEL, CARBON BLACK, TITANIUM DIOXIDE, or LEAD, which are known to the state of California to

C9000 Industrial Interchange Profile

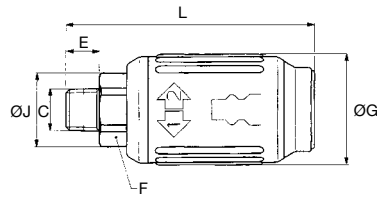

C9000 Industrial Interchange Profile

PART NO.	C NPT	E IN	F MM	ØG IN	ØJ IN	L MM
9405U08 14	1/4	.43	22	1.44	.95	3.27
9405U08 18	3/8	.45	22	1.44	.95	3.29
9405U08 22	1/2	.59	22	1.44	.95	3.43

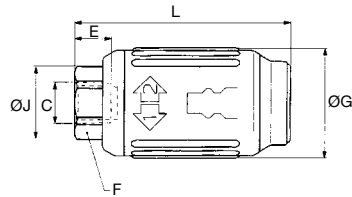

9415U Female Straight Body NPT – 3/8 I.D.

PART NO.	C NPT	E IN	F MM	ØG IN	ØJ IN	L MM
9415U08 14	1/4	.47	22	1.44	.95	2.95
9415U08 18	3/8	.47	22	1.44	.95	2.95
9415U08 22	1/2	.59	27	1.44	1.14	3.15

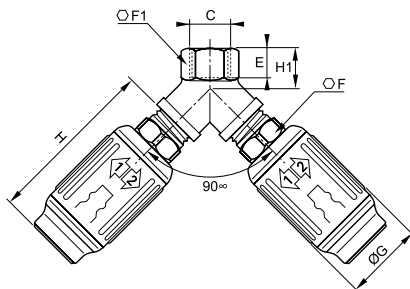

9442U Female Straight Body NPT – 1/4 I.D.

PART NO.	C NPT	E IN	F MM	F1 IN	G IN	H IN	H1 IN
9442U06 18	3/8	.45	19	.79	1.24	2.76	.63

9417U Bulkhead Body NPT – 3/8 I.D.

PART NO.	C NPT	E IN	F MM	F1 MM	ØG IN	ØJ IN	K MAX IN	L1 IN	L2 IN	ØT MIN IN
9417U08 18	3/8	.47	24	24	1.24	.95	.24	.49	2.70	.73

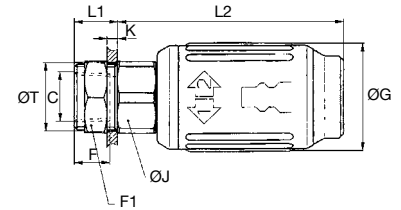

9421U Male Straight Body NPT – 3/8 I.D.

PART NO.	C NPT	E IN	F MM	ØG IN	ØJ IN	L IN
9421U08 06	1/4, 6MM	1.02	22	1.44	.94	3.74
9421U08 08	5/16, 8MM	1.02	22	1.44	.94	3.74
9421U08 10	3/8, 10MM	1.02	22	1.44	.94	3.74
9421U08 13	1/2, 13MM	1.18	22	1.44	.94	3.74

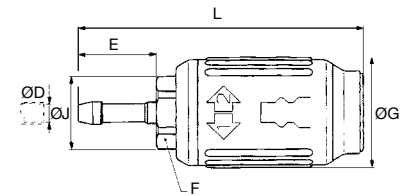

9080U Body + Spring Guard – 3/8 I.D.

PART NO.	C NPT	ØG IN	L IN	L1 MM
9080U08 62	1/2	29.5	4.9	1.02

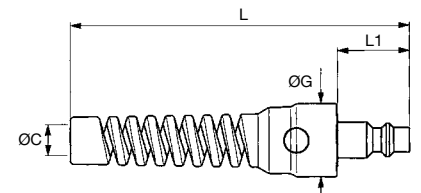

WARNING These products can expose you to chemicals including NICKEL, CARBON BLACK, TITANIUM DIOXIDE, or LEAD, which are known to the state of California to

C9000 Industrial Interchange Profile

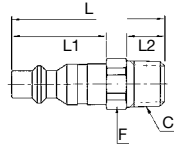

9084 Male Straight NPT – 3/8 I.D.

PART NO.	C NPT	F IN	L IN	L1 IN	L2 IN
9084 30 14	1/4	.67	1.78	1.10	.47
9084 30 18	3/8	.67	1.81	1.10	.47
9084 30 22	1/2	.87	2.02	1.10	.67

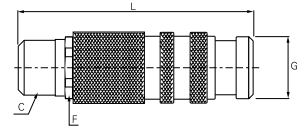

9L05 Male Straight Body NPT – 1/4 I.D.

PART NO.	C NPT	F IN	G IN	L IN
9L05 11 14P180	1/4	11/16	.80	2.21
9L05 11 18P180	3/8	11/16	.80	2.25

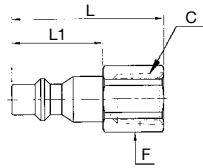

9083 Female Straight NPT – 3/8 I.D.

PART NO.	C NPT	F IN	L IN	L1 IN
9083 30 14	1/4	.67	1.86	1.10
9083 30 18	3/8	.75	1.94	1.10

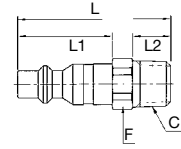

9804 Male Straight NPT – 1/4 I.D.

PART NO.	C NPT	F IN	L IN	L1 IN	L2 IN
9084 23 14	1/4	.551	1.65	.93	.47
9084 23 18	3/8	.669	1.59	.93	.47

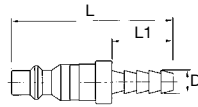

9085 Barbed Connector Body – 3/8 I.D.

PART NO.	D HOSE ID	L IN	L1 IN
9085 30 08	5/16	2.16	1.10
9085 30 60	3/8	2.16	1.10

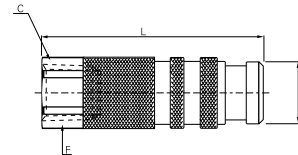

9L04 Female Straight Body NPT – 1/4 I.D.

PART NO.	C NPT	F IN	G IN	L IN
9L04 11 14P180	1/4	11/16	.80	2.00
9L04 11 18P180	3/8	3/4	.80	2.15

WARNING These products can expose you to chemicals including NICKEL, CARBON BLACK, TITANIUM DIOXIDE, or LEAD, which are known to the state of California to

C9000 Industrial Interchange Profile

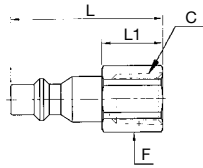

9803 Female Straight NPT – 1/4 I.D.

PART NO.	C NPT	F IN	L IN	L1 IN
9083 23 14	1/4	5/8	1.56	.63
9083 23 18	3/8	13/16	1.60	.67

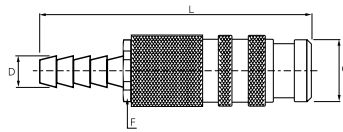

9L85 Barbed Connector Body – 1/4 I.D.

PART NO.	D HOSE ID	F IN	G IN	L IN
9L85 11 14P1	1/4	11/16	.80	2.63
9L85 11 18P1	3/8	11/16	.80	2.63

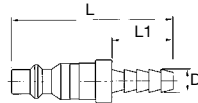

9085 Barbed Connector – 1/4 I.D.

PART NO.	D HOSE ID	L IN	L1 IN
9085 23 56	1/4	1.99	.93
9085 23 08	5/16	1.99	.93
9085 23 60	3/8	1.99	.93

C9000 – ARO 210 Profile

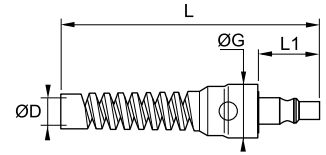

9080A Body + Spring Guard – 1/4 I.D.

PART NO.	ØD	ØG IN	L IN	L1 IN
9080A06 08	5/16, 8MM	.94	4.65	.87

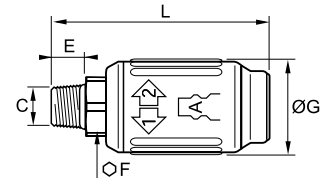

9405A Male Straight Body NPT – 1/4 I.D.

PART NO.	C NPT	E IN	F MM	ØG IN	L IN
9405A06 14	1/4	.47	17	1.24	2.87
9405A06 18	3/8	.49	19	1.24	2.93
9405A06 22	1/2	.63	22	1.24	3.13

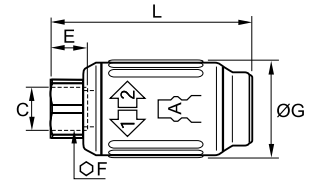

9415A Female Straight Body NPT – 1/4 I.D.

PART NO.	C NPT	E IN	F MM	ØG IN	L IN
9415A06 14	1/4	.47	17	1.24	2.54
9415A06 18	3/8	.47	22	1.24	2.76
9415A06 22	1/2	.59	27	1.24	2.99

WARNING These products can expose you to chemicals including NICKEL, CARBON BLACK, TITANIUM DIOXIDE, or LEAD, which are known to the state of California to

C9000 – ARO 210 Profile

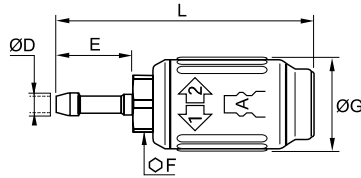

9421A Male Straight Body – 1/4 I.D.

PART NO.	C NPT	E IN	F MM	ØG IN	L IN
9421A06 06	1/4, 6MM	1.02	17	1.24	3.41
9421A06 08	5/16, 8MM	1.02	17	1.24	3.41
9421A06 10	3/8, 10MM	1.02	17	1.24	3.41

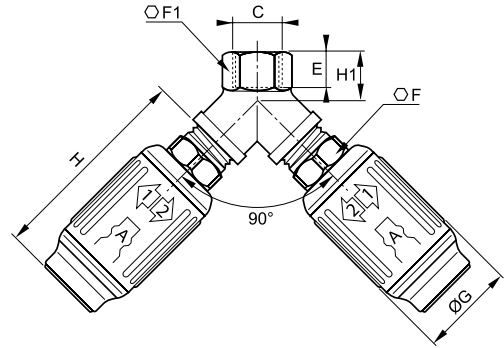

9442A “Y” Connector Body – 1/4 I.D.

PART NO.	C NPT	E IN	F MM	F1 IN	G IN	H IN	H1 IN
9442A06 18	3/8	.45	19	.79	1.24	2.68	.63

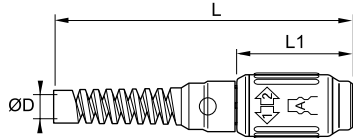

9410A Body + Spring Guard – 1/4 I.D.

PART NO.	ØD	L IN	L1 IN
9410A06 08	5/16, 8MM	5.63	2.13

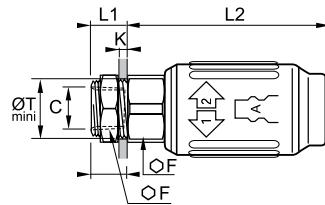

9417A Bulkhead Body NPT – 1/4 I.D.

PART NO.	C NPT	E IN	F MM	K IN	L1 IN	L2 IN	ØT IN
9417A06 14	1/4	.47	22	.24	.49	2.62	.73

WARNING These products can expose you to chemicals including NICKEL, CARBON BLACK, TITANIUM DIOXIDE, or LEAD, which are known to the state of California to



Ball Valves

Legris Standard Series

Brass Series 500

Brass Series 520

Brass Series 525

Micro Series 708/709

Legris Mini Series

Mini Push-In

Legris Stainless Steel

Stainless Steel Series 501SS

Stainless Steel Series 502SS

Polypropylene Ball Valves:
LIQUIfit, TrueSeal and Par-Barb

Axial Valves





GOODYEAR
RUBBER PRODUCTS, INC.

📞 727-342-5088

You can also email us at
GRP@goodyearrubberproducts.com

Female Ports

0402
BSPP
p. H8



4902
BSPP
p. H8



0446
BSPP
p. H9



0472
BSPP
p. H9



0482
BSPP
p. H10



0448
BSPP
p. H10



0452
BSPP
p. H11



0483
BSPP
p. H11



6402
BSPP
p. H11



6401
BSPP
p. H11



0411
p. H12



0414
p. H12



V500P
Female-Female
p. H17



V500P-X-04
Female Ports
p. H17



V500P-X-21
Female Ports
p. H17



V520P
Economy Series
p. H20



V525P
Female-Female
p. H21



MV709
p. H22



MV200
Mini Valve
p. H24



MV609
Mini Valve
p. H24



0492
BSPP
p. H25



0491
BSPP
p. H25



0490
BSPP
p. H25



0497
BSPP
p. H26



0496
BSPP
p. H26



4602
BSPP
p. H26



7913
p. H28



7910
p. H28



4832
BSPP
p. H30



0465
BSPP
p. H30



4810
BSPP
p. H30



V502SS
Panel Mount
Stainless
p. H33



V502SS-X-20
Panel Mount
p. H33



VP502SS
Stainless Steel
p. H33



V502SS-X-21
Oval Handle
p. H33



Male - Male Ports

0400
BSPP
p. H9



Male - Female Ports

0401
BSPP
p. H8



0471
BSPP
p. H9



MV708
p. H22



MV608
Mini Valve
p. H24



7915
NPT
p. H28



7914
BSPP
p. H28



7911
BSPP
p. H28



V501SS
Stainless Steel
p. H31



Padlocking

0432
BSPP
p. H14



0438
BSPP
p. H14



VP500P
Female Ports
p. H17



VP520P
p. H20



Vented

0462
BSPP
p. H10



0461
BSPP
p. H10



0489
NPT, BSPP
p. H13



0449
BSPP
p. H13



0469
BSPP
p. H13



VV500P
Female Ports
p. H17



Vented - Padlocking

0499
NPT
p. H15



0437
BSPP
p. H15



0439
BSPP
p. H15



VVP500P
Female Ports
p. H17



Polypropylene Ball Valves, LIQUIfit

VUC
p. H35



VFC
p. H35



VMC
p. H35



VEU
p. H36



VFE
p. H36



VME
p. H36



■ Polypropylene Ball Valves, TrueSeal

VME
p. H38



VFE
p. H38



VUC
p. H38



VFC
p. H38



VEU
p. H38



VMC
p. H39



VTEU
p. H39



SC
p. H39



TS
p. H39



AQRT
p. H39



■ Polypropylene Ball Valves, Par-Barb

VMC
NPTF
p. H41



VFC
NPTF
p. H41



VME
NPTF
p. H41



VFE
NPTF
p. H41



VEU
p. H41



VUC
p. H41



VUCPB
p. H41



BVC
Ball Valve Clip
p. H41



■ Axial Valves

4203
NPT
p. H44



4202
BSPP
p. H44



4298
Subbase
p. H45



4298
p. H45



4299
p. H45





Ball Valves

Legris Standard Series

This range of valves has patented seal wear compensating technology for reliable and durable sealing, protecting any system whether under pressure or vacuum.

Product Features:

Durability & Reliability

- Automatic seal wear compensation for long-term reliability
- Robust, corrosion-resistant materials
- 100% leak-tested in production
- Date coding to guarantee quality and traceability

Versatility & Performance

- Ideal for ensuring the performance of pneumatic circuits
- Unequaled performance under vacuum
- Large range of working pressures and temperatures
- Lever can be repositioned and replaced
- Configurations to satisfy all system requirements

Applications:

- Pneumatics
- Vacuum
- Transportation
- Packaging
- Textile
- Sawmills
- Rubber & Plastics

Specifications:

Compatible Fluids	Industrial fluids (See application table on pages J23-J25)
Working Pressure	Vacuum to 580 psi (40 bar)
Working Temperature	-4° to 176° F (-20° to 80° C)

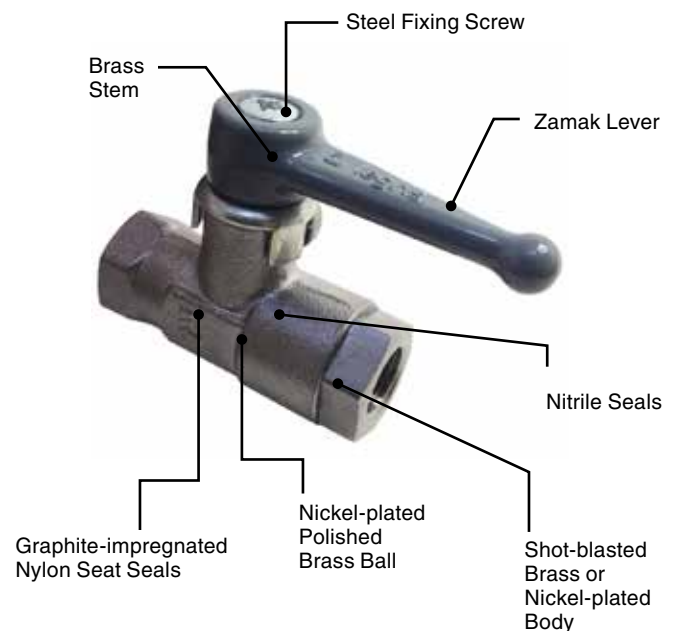

These valves are designed for use where there is a requirement for medium pressure and when the fluid carried requires fluoropolymer seals. It is suitable for many applications, being both high quality and economical.

Materials of Construction:

Body	Forged Brass
Ball	Chrome Plated Brass
Seats/Seals	PTFE
Handle	Steel

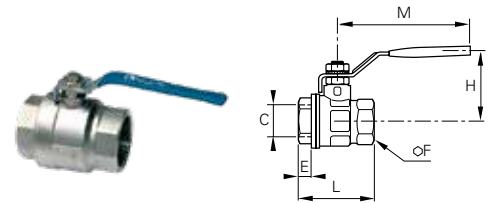
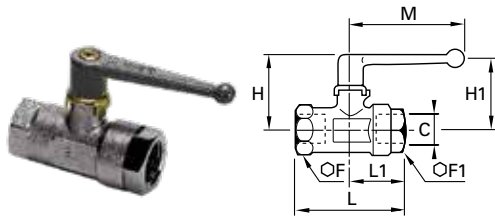

0402 Double Female BSPP

PART NO.	C BSPP	DN	F MM	F1 MM	H MM	H1 MM	L MM	L1 MM	M MM	W OZ
0402 04 10	G1/8	4	-	14	35	29	44	25	48	.09
0402 07 10	G1/8	7	19	19	38	31	51	27	48	.17
0402 07 13	G1/4	7	19	19	38	31	53	28	48	.16
0402 10 17	G3/8	10	24	24	45	43	59	31	69	.23
0402 13 21	G1/2	13	27	27	47	44	67	34	69	.29
0402 20 27	G3/4	20	32	38	63	54	80	39	108	.69
0402 23 34	G1	23	41	46	67	57	94	47	108	1.03
0402 32 42	G1-1/4	32	55	60	97	115	112	59	180	2.43
0402 32 49	G1-1/2	32	55	60	97	115	120	62	180	2.28
0402 40 49	G1-1/2	40	55	55	104	-	111	55	190	2.56
0402 40 48	G2	40	70	70	104	-	122	61	190	2.75

Maximum working pressure: 580 psi

4902 Double Female BSPP

PART NO.	C BSPP	DN	PN	E MM	F MM	H MM	L MM	M MM	W KG
4902 10 13	G1/4	10	30	11	20	43	51.5	98	.14
4902 10 17	G3/8	10	30	11.4	20	43	51.5	98	.13
4902 15 21	G1/2	15	30	13.5	25	47	55	98	.20
4902 20 27	G3/4	20	30	12.5	31	58	57.5	122	.32
4902 25 34	G1	25	30	15	38	60	69.5	122	.49
4902 32 42	G1-1/4	32	25	17	48	77	81.5	153	.90
4902 40 49	G1-1/2	40	25	18	54	83	95	153	1.35
4902 50 48	G2	50	25	22	66	95	113	162	1.80

0401 Male/Female BSPP

PART NO.	C BSPP	DN	F MM	H MM	H1 MM	J MM	L MM	W OZ	M MM	W KG
0401 04 10	G1/8	4	14	35	29	14	45	25	48	.09
0401 05 10	G1/8	5	19	38	31	19	51	27	48	.16
0401 07 13	G1/4	7	19	38	31	19	52	28	48	.15
0401 10 17	G3/8	10	24	45	43	24	58	31	69	.23
0401 13 21	G1/2	13	27	47	44	27	66	34	69	.29
0401 18 27	G3/4	18	38	63	54	39	79	39	108	.71
0401 23 34	G1	23	46	67	57	48	91	47	108	1.03
0401 32 42	G1-1/4	32	60	97	115	55	113	59	180	2.37

Maximum working pressure: 580 psi

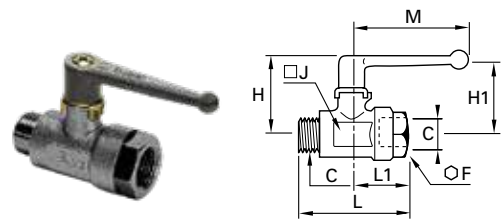

WARNING These products can expose you to chemicals including CARBON BLACK or LEAD, which are known to the state of California to cause cancer.

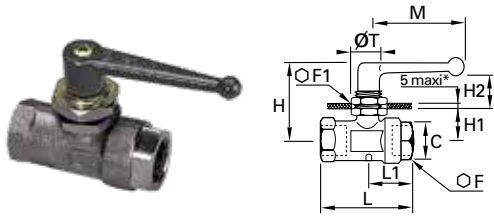

0446 Double Female Panel Mounted BSPP

PART NO.	C BSPP	DN	F MM	F1 MM	H MM	H1 MM	H2 MM	L MM	L1 MM	M MM	T MM	W KG
0446 04 10	G1/8	4	14	22	37	14	12	44	25	48	16.5	.10
0446 07 13	G1/4	7	19	24	45	19	14	53	28	48	20.5	.19
0446 10 17	G3/8	10	24	27	50	21	21	59	31	69	20.5	.29
0446 13 21	G1/2	13	27	27	51	21	21	67	34	69	20.5	.34

Maximum working pressure: 290 psi, for model G 1/8, maximum panel thickness = 3mm (.118 in)

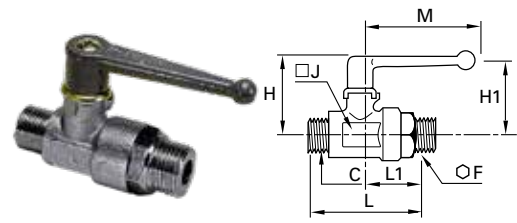

0400 Double Male BSPP

PART NO.	C BSPP	DN	F MM	H MM	H1 MM	J MM	L MM	L1 MM	M MM	W KG
0400 04 10	G1/8	4	14	35	29	14	45	25	48	.09
0400 07 13	G1/4	7	19	38	31	19	60	36	48	.16
0400 10 17	G3/8	10	24	45	43	24	70	43	69	.25
0400 13 21	G1/2	13	27	47	44	27	78	45	69	.33
0400 18 27	G3/4	18	38	63	54	39	90	50	108	.77

Maximum working pressure: 580 psi

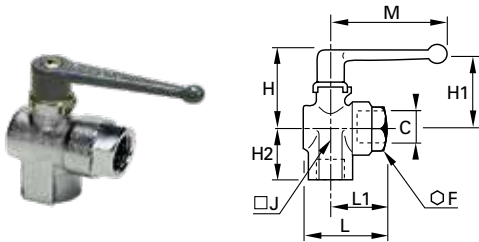

0472 Double Female BSPP

PART NO.	C BSPP	DN	F MM	H MM	H1 MM	H2 MM	J MM	L MM	L1 MM	M MM	W KG
0472 04 10	G1/8	4	14	35	29	18	14	34	25	48	.10
0472 06 10	G1/8	6	19	38	31	20	22	37	27	48	.19
0472 06 13	G1/4	6	19	38	31	24	22	38	28	48	.29
0472 09 17	G3/8	9	24	45	43	27	25	46	31	69	.34
0472 12 21	G1/2	12	27	47	44	33	29	49	34	69	.34
0472 18 27	G3/4	18	38	59	51	40	39	60	39	108	.34

Maximum working pressure: 290 psi

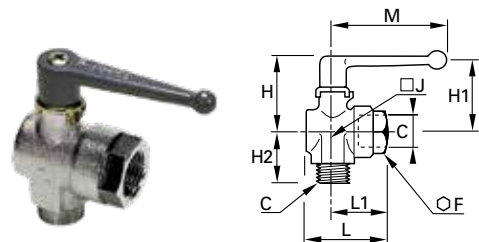

0471 Male and Female BSPP

PART NO.	C BSPP	DN	F MM	H MM	H1 MM	H2 MM	J MM	L MM	L1 MM	M MM	W KG
0471 04 10	G1/8	4	14	35	29	19	14	34	25	48	.10
0471 06 10	G1/8	6	19	38	31	20	22	37	27	48	.17
0471 06 13	G1/4	6	19	38	31	24	22	38	28	48	.17
0471 09 17	G3/8	9	24	45	43	27	25	46	31	69	.26
0471 12 21	G1/2	12	27	47	44	33	29	49	34	69	.31
0471 18 27	G3/4	18	38	59	51	40	39	60	39	108	.72

Maximum working pressure: 290 psi

⚠️ WARNING: These products can expose you to chemicals including CARBON BLACK or LEAD, which are known to the state of California to cause cancer.

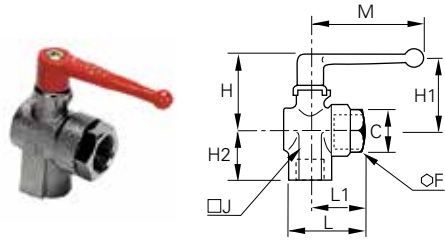

0462 Double Female with Vent BSPP

PART NO.	C BSPP	DN	F MM	H MM	H1 MM	H2 MM	J MM	L MM	L1 MM	M MM	W KG
0462 06 10	G1/8	6	19	38	31	20	22	37	27	48	.18
0462 06 13	G1/4	6	19	38	31	24	22	38	28	48	.18
0462 09 17	G3/8	9	24	45	43	27	25	46	31	69	.27
0462 12 21	G1/2	12	27	47	44	33	29	49	34	69	.31
0462 18 27	G3/4	18	38	59	51	40	39	60	39	108	.73
0462 23 34	G1	23	46	63	55	47	48	72	47	108	1.05

Maximum working pressure: 290 psi

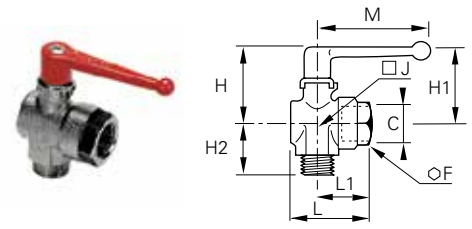

0461 Male and Female with Vent BSPP

PART NO.	C BSPP	DN	F MM	H MM	H1 MM	H2 MM	J MM	L MM	L1 MM	M MM	W KG
0461 06 10	G1/8	6	19	38	31	22	22	37	27	48	.17
0461 06 13	G1/4	6	19	38	31	25	22	38	28	48	.17
0461 09 17	G3/8	9	24	45	43	28	25	46	31	69	.26
0461 12 21	G1/2	12	27	47	44	32	29	49	34	69	.31
0461 18 27	G3/4	18	38	59	51	37	39	60	39	108	.70

Maximum working pressure: 290 psi

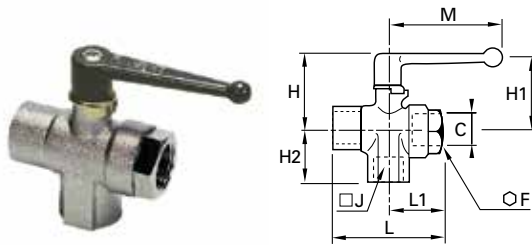

0482 Female Right Angled Porting BSPP

PART NO.	C BSPP	DN	F MM	H MM	H1 MM	H2 MM	J MM	L MM	L1 MM	M MM	W KG
0482 04 10	G1/8	4	14	35	29	18	14	44	25	48	.11
0482 06 13	G1/4	6	19	38	31	24	22	53	28	48	.19
0482 09 17	G3/8	9	24	45	43	27	25	59	31	69	.26
0482 12 21	G1/2	12	27	47	44	33	29	67	34	69	.35
0482 18 27	G3/4	18	38	59	51	40	39	80	39	108	.39
0482 23 34	G1	23	46	63	55	47	48	94	47	108	1.17

Maximum working pressure: 290 psi

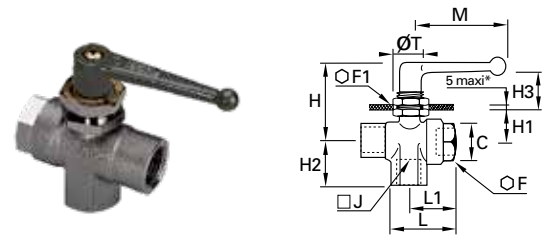

0448 Panel Mountable Female Right Angled Porting BSPP

PART NO.	C BSPP	DN	F MM	F1 MM	H MM	H1 MM	H2 MM	H3 MM	J MM	L MM	L1 MM	M MM	T MM	W KG
0448 04 10	G1/8	4	14	22	37	14	18	12	14	44	25	48	16.5	.12
0448 06 13	G1/4	6	19	24	45	19	24	14	22	53	28	48	20.5	.22
0448 09 17	G3/8	9	24	27	50	21	27	21	25	59	31	69	20.5	.32
0448 12 21	G1/2	12	27	27	51	23	33	21	29	67	34	69	20.5	.40

Maximum working pressure: 290 psi

* G1/8 version: maximum panel thickness = 3mm (.118 in)

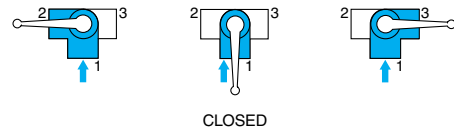
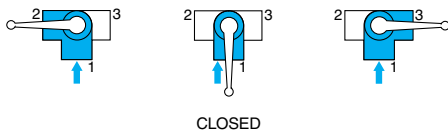

WARNING These products can expose you to chemicals including CARBON BLACK or LEAD, which are known to the state of California to cause cancer.

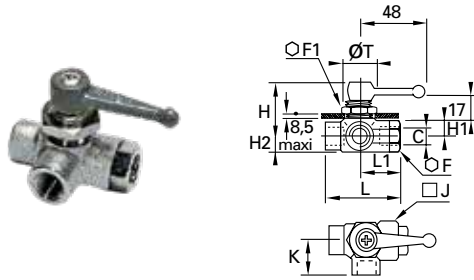

0452 Panel Mountable Female Equal Plane Porting BSPP

PART NO.	C BSPP	DN	F MM	F1 MM	H MM	H1 MM	H2 MM	J MM	K MM	L MM	L1 MM	T MM	W KG
0452 04 10	G1/8	4	14	22	39	10	8	16	18	44	25	19	.32
0452 06 13	G1/4	6	19	24	40	11	11	23	24	53	28	20	.30

Maximum working pressure: 290 psi

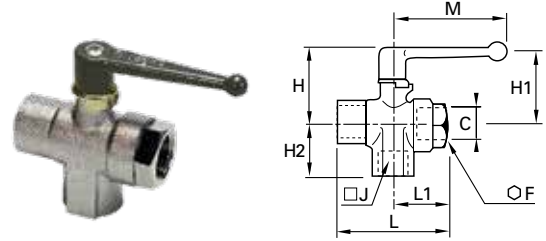
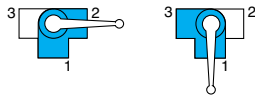

0483 Female Right Angled Porting without Closed Position BSPP

PART NO.	C BSPP	DN	F MM	H MM	H1 MM	H2 MM	J MM	L MM	L1 MM	M MM	W KG
0483 04 10	G1/8	4	14	35	29	18	14	44	25	48	.10
0483 06 13	G1/4	6	19	38	31	24	22	53	28	48	.19
0483 09 17	G3/8	9	24	45	43	27	25	59	31	69	.28
0483 12 21	G1/2	12	27	47	44	33	29	67	34	69	.35
0483 18 27	G3/4	18	38	59	51	40	39	80	39	108	.71
0483 23 34	G1	23	46	63	55	47	48	94	47	108	1.09

Maximum working pressure: 290 psi

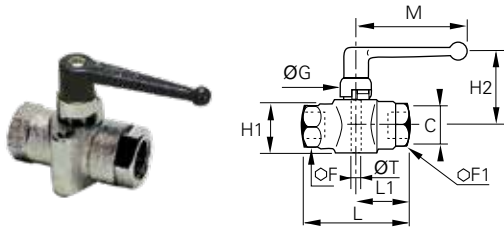
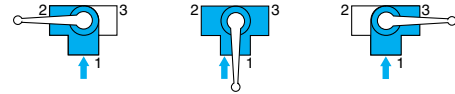

6402 Double Female BSPP

PART NO.	C BSPP	DN	E MM	F MM	F1 MM	G MM	H1 MM	H2 MM	L MM	L1 MM	M MM	T MM	W KG
6402 04 10	G1/8	4	8	14	14	18	18	30	44	25	48	4X70	.13
6402 07 13	G1/4	7	12	19	19	19	24	31	53	28	48	5X80	.22
6402 10 17	G3/8	10	12	24	24	20	30	45	59	31	69	5X80	.32
6402 13 21	G1/2	13	15	27	27	20	34	47	67	34	69	6X100	.39
6402 20 27	G3/4	20	16.5	32	38	27	44	52	80	39	108	8X125	.82
6402 23 34	G1	23	19	41	46	27	53	56	94	47	108	8X125	1.25

Maximum working pressure: 580 psi (40 bar)

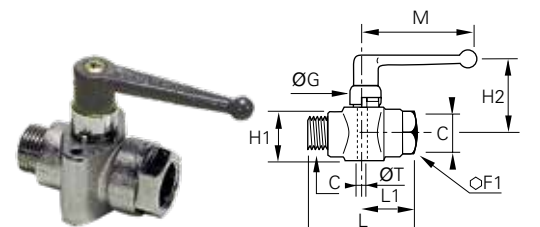
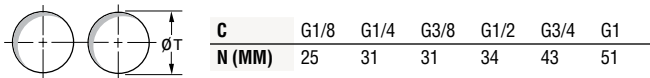

6401 Male and Female BSPP

PART NO.	C BSPP	DN	E MM	E1 MM	F MM	G MM	H1 MM	H2 MM	L MM	L1 MM	M MM	W KG	T MM
6401 04 10	G1/8	4	8	7	14	18	18	30	45	25	48	.13	4X70
6401 07 13	G1/4	7	12	9	19	19	24	31	52	28	48	.22	5X80
6401 10 17	G3/8	10	12	11	24	20	30	45	58	31	69	.32	5X80
6401 13 21	G1/2	13	15	15	27	20	34	47	67	34	69	.39	6X100

Maximum working pressure: 580 psi (40 bar)

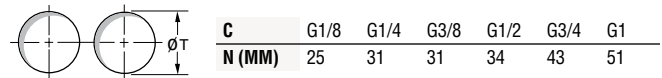

WARNING These products can expose you to chemicals including CARBON BLACK or LEAD, which are known to the state of California to cause cancer.

Different methods of mounting

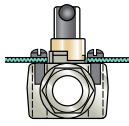

screw fixed mounting on a metal bulkhead with handle above the bulkhead

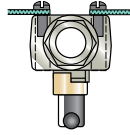

screw fixed mounting on a metal bulkhead with the complete valve below the bulkhead

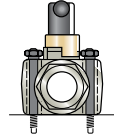

tapped fixing mounting onto a metal plate

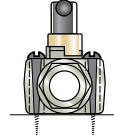

wood screw fixed mounting onto a wooden panel

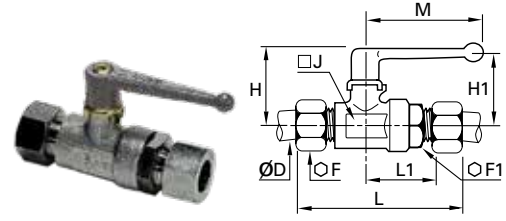
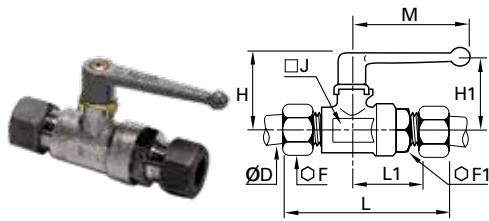

0411 In-Line with Tube Couplings Fitted for Use with Steel Tube

PART NO.	ØD	DN	F MM	F1 MM	H MM	H1 MM	J MM	L MM	L1 MM	M MM	W KG
0411 04 06	6	4	14	19	38	31	19	76	30	48	.073
0411 06 08	8	6	17	19	38	31	19	77	30	48	.095
0411 07 10	10	7	19	19	38	31	19	78	31	48	.100
0411 10 12	12	10	22	24	45	43	24	85	36	69	.110

Maximum working pressure: 580 psi (40 bar)

0414 In-Line with Tube Couplings Fitted with Double Taper Rings

PART NO.	ØD	DN	F MM	F1 MM	H MM	H1 MM	J MM	L MM	L1 MM	M MM	W KG
0414 04 06	6	4	13	19	38	31	19	72	31	48	.177
0414 06 08	8	6	14	19	38	31	19	74	30	48	.180
0414 07 10	10	7	19	19	38	31	19	78	31	48	.210
0414 10 12	12	10	22	24	45	43	24	86	36	69	.308

Maximum working pressure: 580 psi (40 bar)

WARNING These products can expose you to chemicals including CARBON BLACK or LEAD, which are known to the state of California to cause cancer.

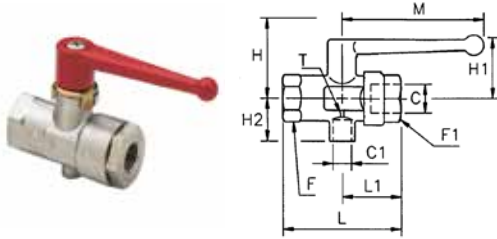

0489 Double Female Vented Ball Valve NPT

PART NO.	C NPT	DN	C1 IN	F IN	F1 IN	H IN	H1 IN	H2 IN	L IN	L1 IN	M IN	T IN	W OZ
0489 07 14	1/4	.27	10-32	.94	.94	1.79	1.68	.66	2.30	1.21	2.69	.08	9.50
0489 10 18	3/8	.39	10-32	.94	.94	1.79	1.68	.66	2.30	1.21	2.69	.08	10.38
0489 13 22	1/2	.51	1/8	1.05	1.05	1.83	1.72	.94	2.61	1.33	2.69	.08	11.01
0489 23 35	1	.90	1/4	1.60	1.79	2.61	2.22	1.44	3.67	1.83	4.21	.12	38.41

Maximum working pressure: 580 psi

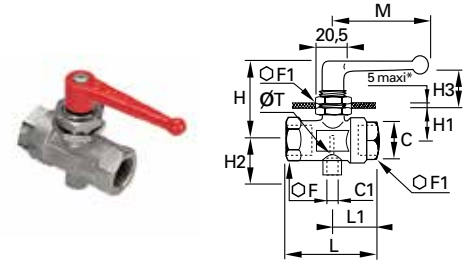

0449 Double Female Ball Valve, Panel Mounted BSPP

PART NO.	C BSPP	DN	C1 MM	F MM	F1 MM	H MM	H1 MM	H2 MM	H3 MM	K MM	L1 MM	M MM	T MM	W KG
0449 07 13	G1/4	7	M5X0.8	24	27	50	20	17	21	59	31	69	2.5	.27
0449 10 17	G3/8	10	M5X0.8	24	27	50	20	17	21	59	31	69	2.5	.29
0449 13 21	G1/2	13	G1/8	27	27	52	23	24	21	67	34	69	4	.31

Maximum working pressure: 290 psi

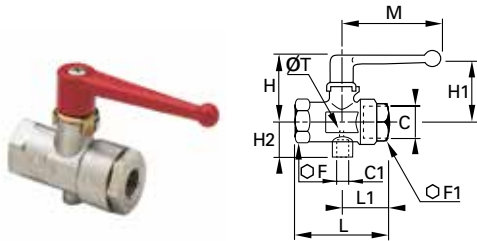

0489 Double Female Vented Ball Valve BSPP

PART NO.	C BSPP	DN	C1 MM	F MM	F1 MM	H MM	H1 MM	H2 MM	L MM	L1 MM	M MM	T MM	W KG
0489 07 13	G1/4	7	M5X0.8	24	24	46	43	17	59	31	69	2	.27
0489 10 17	G3/8	10	M5X0.8	24	24	46	43	17	59	31	69	2	.29
0489 13 21	G1/2	13	G1/8	27	27	47	44	24	67	34	69	2	.31
0489 18 27	G3/4	18	G1/4	32	38	63	54	33	80	39	108	2.5	.75
0489 23 34	G1	23	G1/4	41	46	67	57	37	94	47	108	3	1.09

Maximum working pressure: 580 psi

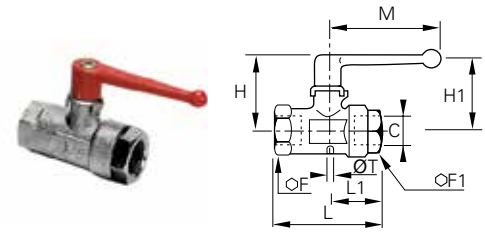

0469 Double Female Vented Ball Valve BSPP

PART NO.	C BSPP	DN	F MM	F1 MM	H MM	H1 MM	L MM	L1 MM	M MM	T MM	W KG
0469 04 10	G1/8	4	-	14	35	29	44	25	48	1.5	.10
0469 07 13	G1/4	7	24	24	46	43	59	31	70	2	.26
0469 10 17	G3/8	10	24	24	46	43	59	31	70	2	.25
0469 13 21	G1/2	13	27	27	47	44	67	34	70	2	.29
0469 18 27	G3/4	18	32	38	63	54	80	39	108	2.5	.70
0469 23 34	G1	23	41	46	67	57	94	47	108	3	1.02

Maximum working pressure: 580 psi

WARNING These products can expose you to chemicals including CARBON BLACK or LEAD, which are known to the state of California to cause cancer.

These valves are lockable in the closed position only.

Right angle ported ball allows flow:
Port 1 to port 2 or from port 2 to port 3

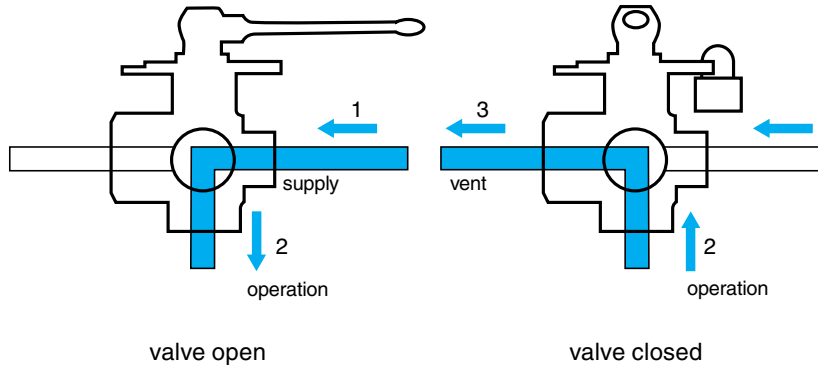

removable handle: where the handle is obstructed in its movement it can be refitted opposite the original position.

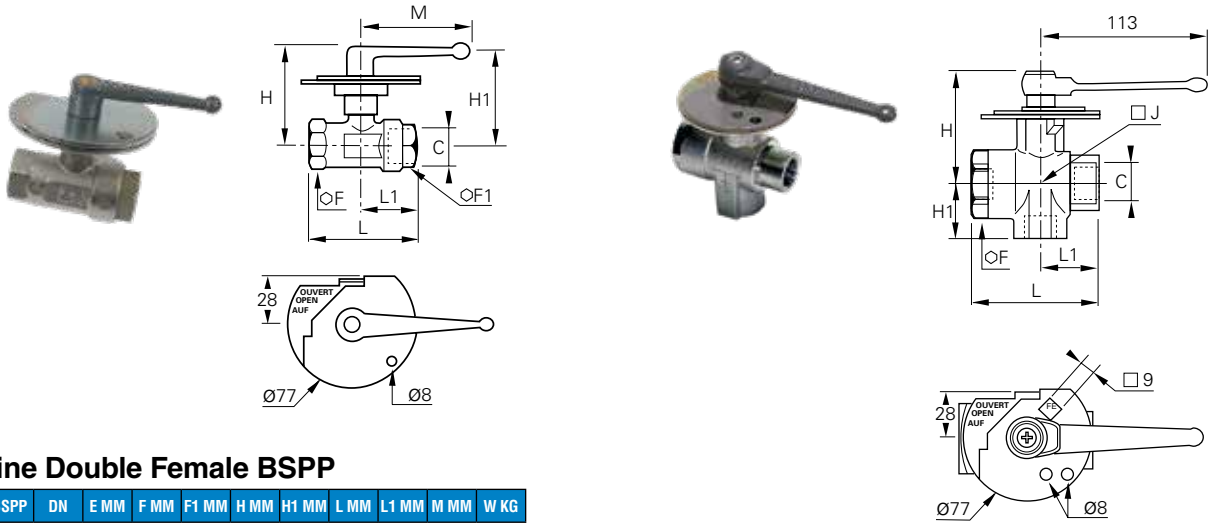

0432 In-Line Double Female BSPP

PART NO.	C BSPP	DN	E MM	F MM	F1 MM	H MM	H1 MM	L MM	L1 MM	M MM	W KG
0432 04 10	G1/8	4	8	19	19	59	54	51	27	69	.41
0432 07 13	G1/4	7	12	19	19	59	54	59	28	69	.40
0432 10 17	G3/8	10	12	24	24	60	55	59	31	69	.46
0432 13 21	G1/2	13	15	27	27	62	57	67	34	69	.52
0432 20 27	G3/4	20	16.5	32	38	66	56	80	39	108	.85
0432 23 34	G1	23	19	41	46	70	59	94	47	108	1.17

Maximum service pressure: 580 psi, handle is non-removable.

0438 Female 3 Way Lockable Ball Valve BSPP

PART NO.	C BSPP	DN	E MM	F MM	H MM	H1 MM	J MM	L MM	L1 MM	W KG
0438 09 17	G3/8	9	12	38	76	34	39	73	35	.91
0438 12 21	G1/2	12	15	38	76	37	39	78	38	.90
0438 18 27	G3/4	18	16.5	38	76	40	39	80	40	.85
0438 23 34	G1	23	19	46	80	47	48	94	47	1.27

Maximum working pressure: 290 psi

WARNING These products can expose you to chemicals including CARBON BLACK or LEAD, which are known to the state of California to cause cancer.

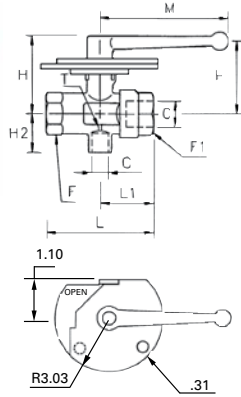

0499 Double Female Lockable Vented Ball Valve NPT

PART NO.	C NPT	DN	C1 IN	F IN	F1 IN	H IN	H1 IN	H2 IN	L IN	L1 IN	M IN	T IN	W KG
0499 10 18	3/8	.89	10-32	.94	.94	1.79	1.68	.66	2.30	1.21	2.69	.08	11.71
0499 13 22	1/2	.51	1/8	1.05	1.05	1.83	1.72	.94	2.61	1.33	2.69	.08	11.39
0499 18 28	3/4	.70	1/4	1.25	1.25	2.46	2.11	1.29	3.12	1.52	4.21	.10	26.95
0499 23 35	1	.90	1/4	1.60	1.60	2.61	2.22	1.44	3.67	1.83	4.21	.12	38.74

These ball valves are OSHA approved.

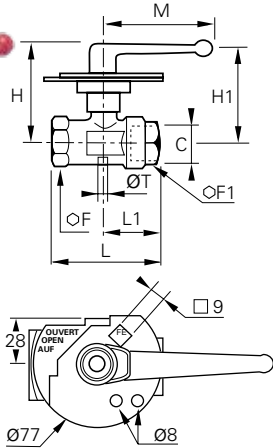

0437 In-Line Double Female Vented Lockable Ball Valve BSPP

PART NO.	C BSPP	DN	E MM	F MM	F1 MM	H MM	L MM	L1 MM	M MM	T MM	W KG
0437 07 13	G1/4	7	12	24	24	60	59	32	69.5	2	.40
0437 10 17	G3/8	10	12	24	24	60	60	32	69.5	2	.46
0437 13 21	G1/2	13	15	27	27	60	67.5	34.5	69.5	2	.52
0437 18 27	G3/4	18	16.5	32	38	69.5	80	39.5	108.5	2.5	.85
0437 23 34	G1	23	19	41	46	70	94.5	47.5	108.5	3	1.17

Maximum working pressure: 580 psi, handle is non-removable.

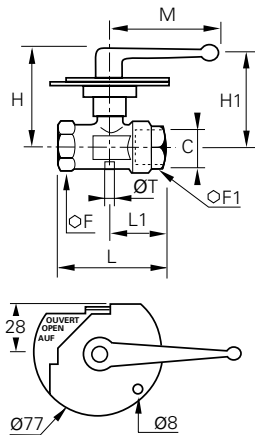

0439 Double Female With Vent BSPP

PART NO.	C BSPP	DN	E MM	F MM	F1 MM	H MM	H1 MM	L MM	L1 MM	M MM	T MM	W KG
0439 04 10	G1/8	4	8	19	19	59	54	51	27	69	2	.42
0439 07 13	G1/4	7	12	24	24	60	55	59	31	69	2	.48
0439 10 17	G3/8	10	12	24	24	60	55	59	31	69	2	.46
0439 13 21	G1/2	13	15	27	27	62	57	67	34	69	2	.51
0439 18 27	G3/4	18	16.5	32	38	66	56	80	39	108	2.5	.83
0439 23 34	G1	23	19	41	46	70	59	94	47	108	3	1.17

Maximum service pressure: 580 psi, handle is non-removable.

WARNING These products can expose you to chemicals including CARBON BLACK or LEAD, which are known to the state of California to cause cancer.

Ball Valves Brass Series 500



Parker's industrial ball valves are intended for general purpose use. Ball valves are intended for use in the fully open or closed positions. Throttling of the valve may result in premature seal failure and/or inability to turn the valve handle.

Product Features:

- Forged brass body
- Chrome plated brass ball
- PTFE seats/seals
- Steel handle

Style:

- V-Valve
- VP-Valve, padlocking handle
- VV-Valve, vented
- VVP-Valve, vented, padlocking handle

Type:

- 500-Female/Female PTF ports

Material:

- P-Brass
- PN-Nickel plated

Options:

- 01-Stainless Steel Ball & Stem
- 02-Stainless Steel Handle & Nut
- 03-Stainless Steel Ball, Stem, Handle & Nut
- 04-Tee Handle
- 08-Unmarked yellow vinyl handle cover
- 21-Oval Handle

Specifications:

Pressure Range:

- 600 WOG , Cold Non-shock
- Saturated Steam up to 150 PSI (10.3 bar)
- Vacuum Service to 29 Inches Hg
- Vented up to 250 PSI (17.2 bar)

Temperature Range

- 0° to +350° F (-17.7° to +176.6° C)

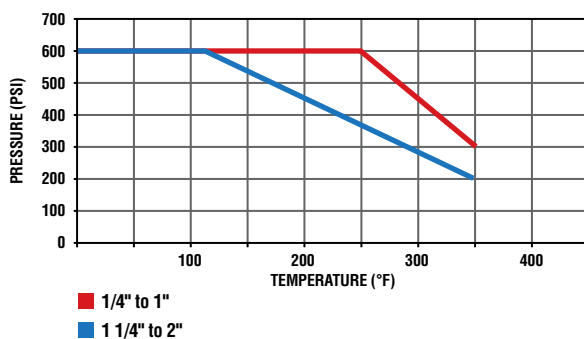

FLOW DATA	
VALVE SIZE	CV
1/4	4.0
3/8	5.8
1/2	12.0
3/4	25.0
1	35.0
1-1/4*	57.0
1-1/2*	92.0
2*	224.0

*For these part numbers only the * options are available.

Female-Female Pipe Ends V500P

PART NO.	PIPE THREAD [PTF]	B HEX	C HEX	H	L	M	N	FLOW DIA. D
V500P-4	1/4	15/16	15/16	3.96	4.90	2.03	2.47	.375
V500P-6	3/8	15/16	15/16	3.96	4.90	2.03	2.47	.375
V500P-8	1/2*	1-1/16	1-1/16	3.96	5.00	2.20	2.58	.500
V500P-12	3/4**	1-1/4	1-5/16	3.96	5.25	2.42	2.81	.685
V500P-16	1**	1-1/2	1-9/16	3.96	5.34	2.75	3.08	.875

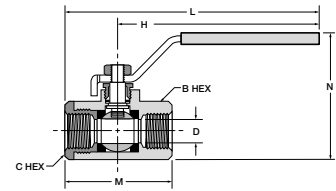

Female-Female Pipe Ends V500P-20, V500P-24, V500P-32

PART NO.	PIPE THREAD [NPT]	OCTAGON	H	L	M	N	FLOW DIA. D
V500P-20	1-1/4	1.93	6.22	8.05	3.66	3.01	1.18
V500P-24	1-1/2	2.13	6.22	8.23	4.02	3.25	1.50
V500P-32	2	2.69	6.22	8.58	4.76	3.52	1.89

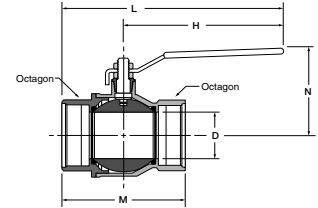

Vented, Female Pipe Ends VV500P

PART NO.	PIPE THREAD [PTF]	B HEX	C HEX	K	H	L	M	N	D FLOW Ø
VV500P-4	1/4	15/16	15/16	1.11	3.96	4.90	2.03	2.47	.375
VV500P-6	3/8	15/16	15/16	1.11	3.96	4.90	2.03	2.47	.375
VV500P-8	1/2*	1-1/16	1-1/16	1.23	3.96	5.00	2.20	2.58	.500
VV500P-12	3/4**	1-1/4	1-5/16	1.45	3.96	5.25	2.42	2.81	.685
VV500P-16	1**	1-1/2	1-9/16	1.58	3.96	5.34	2.75	3.08	.875

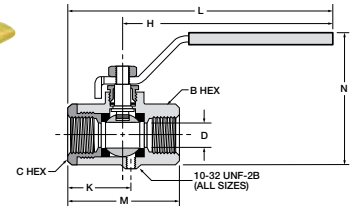

Locking Handle, Female Pipe Ends VP500P

PART NO.	PIPE THREAD [PTF]	B HEX	C HEX	H	L	M	N	D FLOW Ø
VP500P-4	1/4	15/16	15/16	3.96	4.90	2.03	2.47	.375
VP500P-6	3/8	15/16	15/16	3.96	4.90	2.03	2.47	.375
VP500P-8	1/2*	1-1/16	1-1/16	3.96	5.00	2.20	2.58	.500
VP500P-12	3/4**	1-1/4	1-5/16	3.96	5.25	2.42	2.81	.685
VP500P-16	1**	1-1/2	1-9/16	3.96	5.34	2.75	3.08	.875
FOR USE WITH 5/16" Ø SHANK LOCK; .330								
VP500P-20	1-1/4	1-15/16	1-15/16	6.22	8.05	3.66	4.04	1.180
VP500P-24	1-1/2	2-1/8	2-1/8	6.22	8.23	4.02	4.52	1.500
VP500P-32	2	2-11/16	2-11/16	6.22	8.60	4.76	5.07	1.890
FOR USE WITH 9/32" Ø SHANK LOCK; .310								

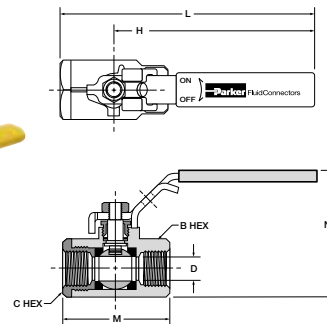

OSHA 29 CFR Part 1910 Vented, Locking Handle, Female Pipe Ends VVP500P

PART NO.	PIPE THD [PTF]	B HEX	C HEX	K	H	L	M	N	D FLOW Ø
VVP500P-4	1/4	15/16	15/16	1.11	3.96	4.90	2.03	2.47	.375
VVP500P-6	3/8	15/16	15/16	1.11	3.96	4.90	2.03	2.47	.375
VVP500P-8	1/2*	1-1/16	1-1/16	1.23	3.96	5.00	2.20	2.58	.500
VVP500P-12	3/4**	1-1/4	1-5/16	1.45	3.96	5.25	2.42	2.81	.685
VVP500P-16	1**	1-1/2	1-9/16	1.58	3.96	5.34	2.75	3.08	.875
FOR USE WITH 5/16" Ø SHANK LOCK									

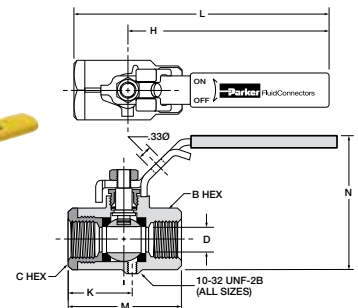

*PTF Special Short. **PTF SPL Extra Short

WARNING These products can expose you to chemicals including CARBON BLACK or LEAD, which are known to the state of California to cause cancer.

Tee Handle, Female Pipe Ends V500P-X-04

PART NO.	PIPE THREAD (PTF)	B HEX	C HEX	H	L	M	N	D FLOW Ø
V500P-4-04	1/4	15/16	15/16	1.25	2.50	2.03	1.87	.375
V500P-6-04	3/8	15/16	15/16	1.25	2.50	2.03	1.87	.375
V500P-8-04	1/2*	1-1/16	1-1/16	1.25	2.50	2.20	1.98	.500
V500P-12-04	3/4**	1-1/4	1-5/16	1.25	2.50	2.42	2.20	.685
V500P-16-04	1**	1-1/2	1-9/16	1.25	2.50	2.75	2.48	.875

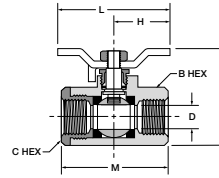

Oval Handle, Female Pipe Ends V500P-X-21

PART NO.	PIPE THREAD (PTF)	B HEX	C HEX	H	L	M	N	D FLOW Ø
V500P-4-21	1/4	15/16	15/16	1.74	3.49	2.03	2.38	.375
V500P-6-21	3/8	15/16	15/16	1.74	3.49	2.03	2.38	.375
V500P-8-21	1/2*	1-1/16	1-1/16	1.74	3.49	2.20	2.49	.500
V500P-12-21	3/4**	1-1/4	1-5/16	1.74	3.48	2.42	2.71	.685
V500P-16-21	1**	1-1/2	1-9/16	1.74	3.48	2.75	2.99	.875

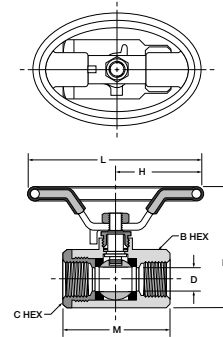

*PTF Special Short. **PTF SPL Extra Short

WARNING These products can expose you to chemicals including CARBON BLACK or LEAD, which are known to the state of California to cause cancer.

Ball Valves Brass Series 520



Product Features:

- Forged brass body
- Chrome plated brass ball
- PTFE seats/seals
- Fluorocarbon Stem O-rings
- Steel handle

Style:

- V-Valve
- VP-Valve, padlocking handle

Type:

- 520-Female/Female NPT Ports

Material:

- P-Brass

Options:

- 04-Tee Handle

Specifications:

Pressure Range:

- 600 WOG Cold Non-shock 1/4" – 2"
- 450 WOG, Cold Non-shock 2 1/2" – 3"
- Saturated Steam up to 150 PSI (10.3 bar)
- Vacuum Service to 29 Inches Hg

Temperature Range

- -40° to +350° F (-40° to +176.6° C)

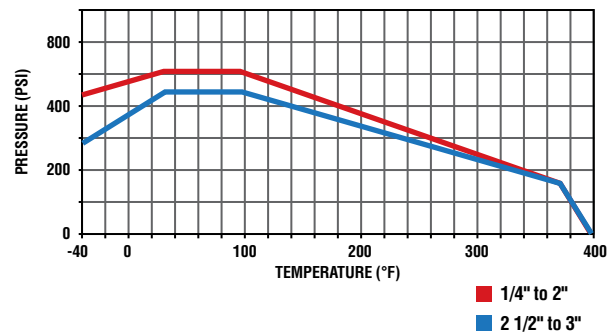

U.L. LISTED	
CATEGORY	
YSDT	LP-GAS SHUT-OFF VALVES
YRBX	FLAMMABLE LIQUID SHUT-OFF VALVES
YRPV	GAS SHUT-OFF VALVES
YQNZ	COMPRESSED GAS SHUT-OFF VALVES

Female Pipe Ends V520P

PART NO.	PIPE THREAD (NPT)	B OCTAGON	C OCTAGON	H	L	M	N	D FLOW Ø
V520P-4	1/4-18	.67	.67	3.94	4.83	1.77	1.50	.310
V520P-6	3/8-18	.79	.79	3.94	4.83	1.77	1.50	.400
V520P-8	1/2-14	.98	.98	3.94	5.10	2.32	1.69	.600
V520P-12	3/4-14	1.22	1.22	4.72	5.98	2.52	1.97	.790
V520P-16	1-11.5	1.57	1.57	4.72	6.32	3.19	2.13	1.000
V520P-20	1-1/4	1.93	1.93	6.22	8.05	3.66	2.82	1.180
V520P-24	1-1/2	2.13	2.13	6.22	8.23	4.02	3.06	1.570
V520P-32	2	2.69	2.69	6.22	8.58	4.76	3.33	2.000
V520P-40	2-1/2	3.35	3.35	10.04	13.11	6.14	5.20	2.520
V520P-48	3	3.89	3.89	10.04	13.52	6.97	5.51	3.000

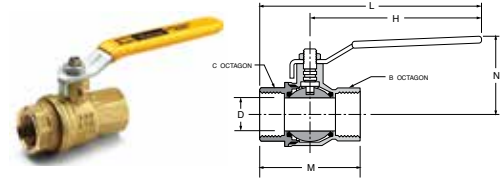

Locking Handle, Female Pipe Ends VP520P

PART NO.	PIPE THREAD (NPT)	B OCTAGON	C OCTAGON	H	L	M	N	D FLOW Ø
VP520P-4	1/4-18	.67	.67	3.94	4.83	1.77	1.50	.310
VP520P-6	3/8-18	.79	.79	3.94	4.83	1.77	1.50	.400
VP520P-8	1/2-14	.98	.98	3.94	5.10	2.32	1.69	.600
VP520P-12	3/4-14	1.22	1.22	4.72	5.98	2.52	1.97	.790
VP520P-16	1-11.5	1.57	1.57	4.72	6.32	3.19	2.13	1.000
VP520P-20	1-1/4	1.93	1.93	6.22	8.05	3.66	2.82	1.180
VP520P-24	1-1/2	2.13	2.13	6.22	8.23	4.02	3.06	1.570
VP520P-32	2	2.69	2.69	6.22	8.58	4.76	3.33	2.000
VP520P-40	2-1/2	3.35	3.35	10.04	13.11	6.14	5.20	2.520
VP520P-48	3	3.89	3.89	10.04	13.52	6.97	5.51	3.000

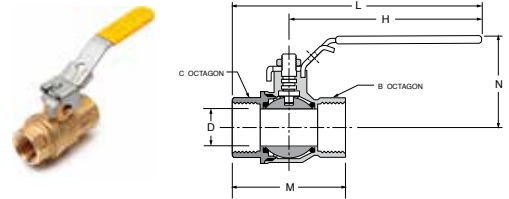

WARNING These products can expose you to chemicals including NICKEL or LEAD, which are known to the state of California to cause cancer.

Ball Valves Brass Series 525



Parker's industrial ball valves are intended for general purpose use. Ball valves are intended for use in the fully open or closed positions. Throttling of the valve may result in premature seal failure and/or inability to turn the valve handle.

Product Features:

- Forged brass body
- Chrome plated brass ball
- PTFE seats/seals
- Steel handle
- Standard Port
- Female/Female NPT Ports

Specifications: Pressure Range:

- 600 WOG Cold Non-shock 1/2" – 2"
- Vacuum Service to 29 Inches Hg

Temperature Range

- -40° to +350° F (-40° to +176.6° C)

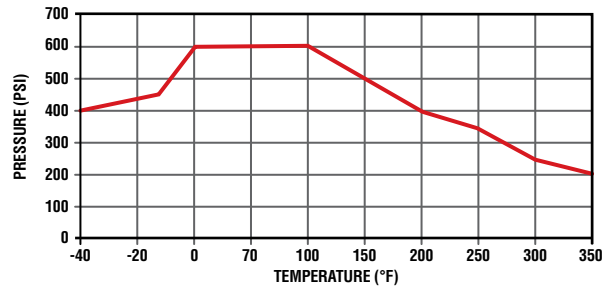

Flow Coefficient

VALUE SIZE	1/2"	3/4"	1"	1-1/4"	1-1/2"	2"
CV	8.4	16	22	38	52	78

Female Pipe Ends, V525P

PART NO.	D	DN	I	L	G	A	H	CH
V525P-8	1/2"	.453	.610	2.126	1.043	3.89	1.62	.984
V525P-12	3/4"	.590	.669	2.441	1.220	3.89	1.69	1.220
V525P-16	1"	.748	.827	2.835	1.417	4.72	1.98	1.496
V525P-20	1 1/4"	.945	.905	3.464	1.732	4.72	2.15	1.929
V525P-24	1 1/2"	1.181	.905	3.779	1.890	6.23	2.97	2.126
V525P-32	2"	1.496	1.043	4.409	2.205	6.23	3.24	2.677

Note: For larger sizes, please contact the division. Packing nut may need to be tightened depending on application temperature. Periodically check the packing nut and tighten as required

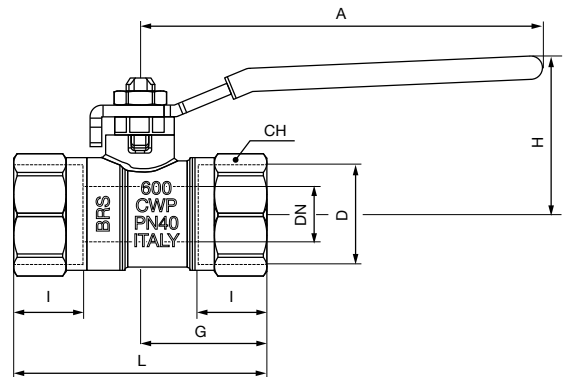

Ball Valves Micro Series 708/709



Product Features:

- Brass Body
- Chrome Plated Brass Ball
- PTFE Seats/Seals
- Nitrile Stem Seal
- Chrome Plated Steel Handle

Style:

- MV-Micro Valve

Type:

- 708-Male/Female
- 709-Female/Female

Specifications:

Pressure Range:

- Up to 500 PSI (34.4 bar)
- Vacuum service 29 inches Hg

Temperature Range

- -35° to +300° F (-37.2 to +148.8° C)

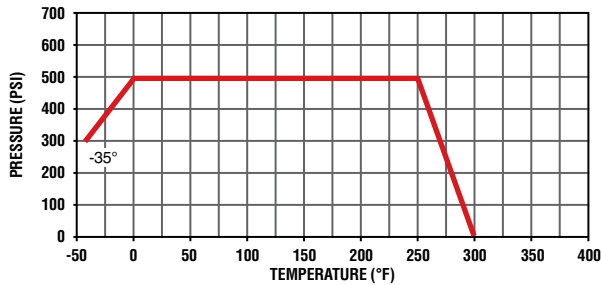

FLOW DATA		
VALVE SIZE	MV708 CV	MV709 CV
1/4	.95	.95

Male-Female Pipe Ends, Mini Ball Valve MV708

PART NO.	PIPE THREAD	B HEX	H	L	M	N	P	FLOW DIA. D
MV708-2	1/8	9/16	1.18	.63	1.62	.93	.38	.180
MV708-4	1/4	11/16	1.52	.70	1.57	.79	.50	.210

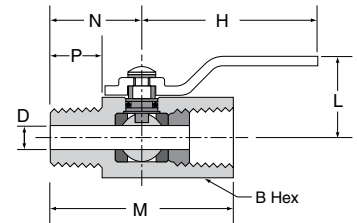

Female Pipe Ends, Mini Ball Valve MV709

PART NO.	PIPE THREAD	B HEX	H	L	M	N	FLOW DIA. D
MV709-2	1/8	9/16	1.18	.63	1.52	.68	.180
MV709-4	1/4	11/16	1.52	.70	1.57	.76	.210

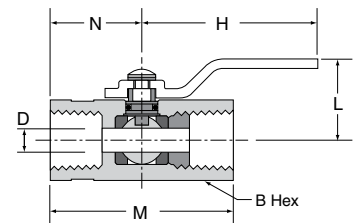

Ball Valves Legris Mini Series



Using the Universal Light Series technology, the Parker Legris light series valves offer the advantages of compactness, ease of operation and long-term reliability.

Product Features:

Easy-to-Use

- Ease of operation due to the low friction design
- The short levers may be repositioned and exchanged
- Extremely compact

Maximum Efficiency

- Excellent performance under vacuum
- Full flow
- Chemical nickel-plated brass with high phosphorous content for outstanding corrosion resistance

Reliability

- Tried-and-tested technology
- Forged brass provides mechanical strength and long service life
- 100% leak-tested in production
- Date coding to guarantee quality and traceability

Applications:

- Vacuum
- Transportation
- Packaging
- Textile
- Sawmills
- Rubber & Plastics

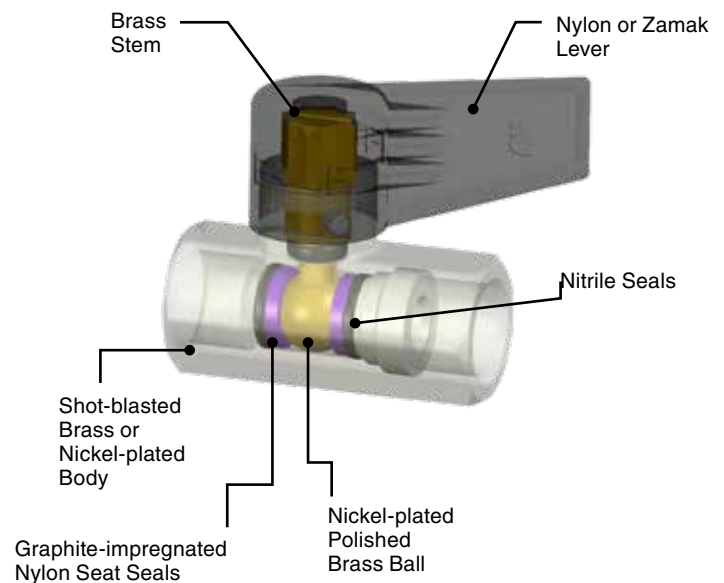

Female Pipe Ends, Lever Handle, Mini Ball Valve MV200

PART NO.	PIPE THREAD	HEX	B	C	H	L	FLOW DIA. D
MV200-2	1/8	.83	1.71	1.20	.91	2.83	.31
MV200-4	1/4	.83	1.71	1.20	.91	2.83	.31
MV200-6	3/8	.83	1.71	1.20	.91	2.83	.31
MV200-8	1/2	.98	2.11	1.28	1.10	2.83	.39

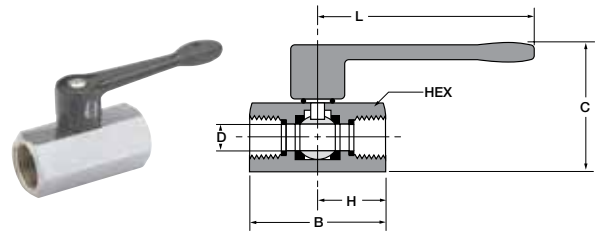

Male-Female Pipe Ends, Compact Handle, Mini Ball Valve MV608

PART NO.	PIPE THREAD	A HEX	B	C	FLOW DIA. D
MV608-2	1/8	.83	1.72	1.22	.20
MV608-4	1/4	.83	1.72	1.22	.31
MV608-6	3/8	.83	1.72	1.22	.31
MV608-8	1/2	.98	2.11	1.30	.39

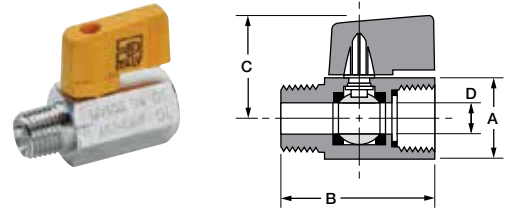

Female Pipe Ends, Compact Handle, Mini Ball Valve MV609

PART NO.	PIPE THREAD	A HEX	B	C	FLOW DIA. D
MV609-2	1/8	.83	1.71	1.22	.24
MV609-4	1/4	.83	1.71	1.22	.31
MV609-6	3/8	.83	1.71	1.22	.31
MV609-8	1/2	.98	2.11	1.30	.39
MV609-6-4	3/8X1/4	.83	1.71	1.22	.31

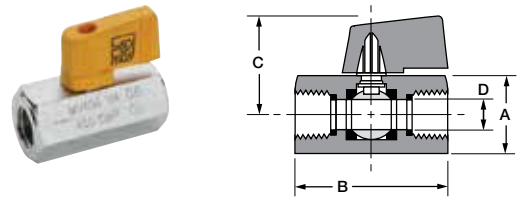

WARNING These products can expose you to chemicals including CARBON BLACK or LEAD, which are known to the state of California to cause cancer.

Light Series Ball Valves allow the passage of many fluids and are suited to high pressures and temperatures. Their materials of construction are the same as for the standard range.

Technical Specifications:

Maximum Working Pressure 175 psi (12 bar)

Maximum Temperature -4° to 176° F (-20° to 80° C)

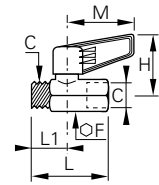

0491 Male and Female BSPP

PART NO.	C BSPP	DN	E MM	E1 MM	F MM	H MM	L MM	L1 MM	M MM	W KG
0491 04 13	G1/4	4	9	7	17	34	39.5	17	35	.07
0491 04 13 64*	G1/4	4	9	7	17	36	39.5	17	25	.07
0491 07 17	G3/8	7	11	8	22	38	45	20	43	.12
0491 10 21	G1/2	10	12	10	24	44	53	24	50	.15
0491 13 27	G3/4	13	14	12	30	46	59	25	50	.23

* Zamac short handle

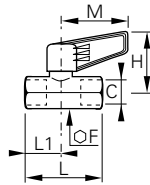

0492 Double Female BSPP

PART NO.	C BSPP	DN	E MM	F MM	H MM	L MM	L1 MM	M MM	W KG
0492 04 13	G1/4	4	9	17	34	39.5	17	35	.07
0492 04 13 64*	G1/4	4	9	17	36	39.5	17	25	.07
0492 07 17	G3/8	7	11	22	38	45	20	43	.12
0492 10 21	G1/2	10	12	24	44	54	25	50	.16
0492 13 27	G3/4	13	14	30	46	62	28	50	.24

* Zamac short handle

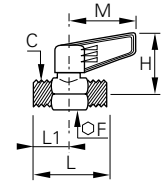

0490 Double Male BSPP

PART NO.	C BSPP	DN	E MM	F MM	H MM	L MM	L1 MM	M MM	W KG
0490 04 13	G1/4	4	9	17	34	39	17	35	.07
0490 07 17	G3/8	7	11	22	38	44	20	43	.11
0490 10 21	G1/2	10	12	24	44	53	24	50	.15
0490 13 27	G3/4	13	14	30	46	59	25	50	.22

WARNING These products can expose you to chemicals including CARBON BLACK or LEAD, which are known to the state of California to cause cancer.

Light series ball valves are usable for the passage of fluids at low pressure and temperatures.

Technical Specifications:

Maximum Working Pressure 174 psi (12 bar)

Max. Working Temperature -4° to 176° F (-20° to 80° C)

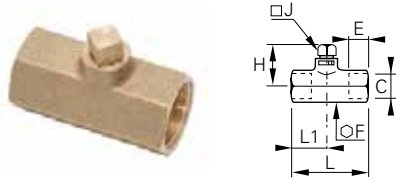

0497 Double Female with Square Stem BSPP

PART NO.	C BSPP	DN	E MM	F MM	H MM	L MM	L1 MM	M MM	W KG
0497 04 13	G1/4	4	9	17	25	7	39	17	.07
0497 07 17	G3/8	7	11	22	26	7	45	20	.11
0497 10 21	G1/2	10	12	24	29	10	54	25	.14
0497 13 27	G3/4	13	14	30	30	10	62	28	.23

The internal component used to shut-off the flow of **Legris lenticular shut-off valves** is a segment of a sphere. Therefore, these valves are usable with abrasive fluids (including solid particles). Lenticular valves can only accommodate fluid flow in one direction. The fluid direction is shown by an arrow on the valve body. The main advantages of this range are low operating torque even with high fluid pressure due to small friction coefficient of lenticule on the ball seal, perfect sealing, small overall dimensions and long life.

Technical Specifications:

Maximum Working Pressure 232 psi (16 bar)

Working Temperature -4° to 174° F (-20° to 80° C)

Compatible Fluids Compressed air, industrial gas, water, cutting oil, mineral oil, fuel, inert gases, solid particles

Lenticule Stainless Steel

Seal Nitrile

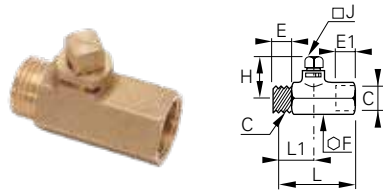

0496 Male and Female with Square Stem BSPP

PART NO.	C BSPP	DN	E MM	F MM	H MM	L MM	L1 MM	M MM	W KG
0496 04 13	G1/4	4	9	17	25	7	39	17	.07
0496 07 17	G3/8	7	11	22	26	7	45	20	.10
0496 10 21	G1/2	10	12	24	29	10	53	24	.14
0496 13 27	G3/4	13	14	30	30	10	59	25	.22

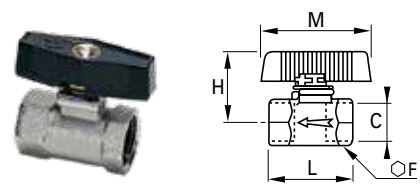

4602 Double Female BSPP

PART NO.	C BSPP	DN	E MM	F MM	H MM	L MM	M MM
4602 06 14	G1/4	9	17	35	34	54	.10
4602 07 17	G3/8	11	22	35	39	54	.14
4602 10 21	G1/2	12	24	37	42	54	.14
4602 13 27	G1/4	14	30	40	49	54	.21
4602 18 34	G1	15	41	46	55	54	.41

WARNING: These products can expose you to chemicals including CARBON BLACK or LEAD, which are known to the state of California to cause cancer.

Ball Valves Mini Push-In



With their push-in connections, these polymer lightweight ball valves allow for a significant reduction in installation time while offering full flow capability and compact dimensions.

Product Advantages:

Optimum Solution

- Full Flow
- Marked with the pneumatic symbol for identification of its function
- Lightweight and compact
- Extremely compact, easy-to-operate lever
- Lever with screwdriver slot to facilitate operation

Proven Technology

Three in-line versions:

- Excellent static and dynamic sealing
- High-strength polyamide
- Automatic seal wear compensation for long-term reliability
- 100% leak-tested in production
- Date coding to guarantee quality and traceability

Applications:

- Robotics
- Vacuum
- Semi-Conductors
- Packaging
- Textile
- Pneumatics

Specifications:

Compatible Fluids	Compressed air only
Pressure Range	145 psi (10 bar)
Temperature Range	-4° to 176° F (-20° to 80° C)

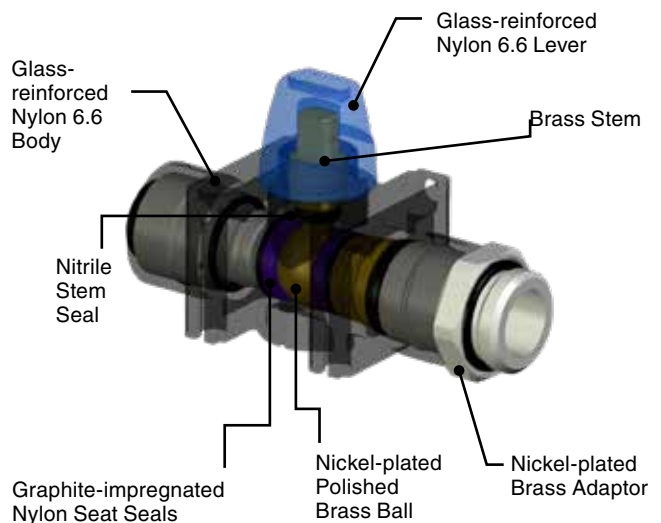

Click here for CADs, Product Specifications or to Configure Parts Online

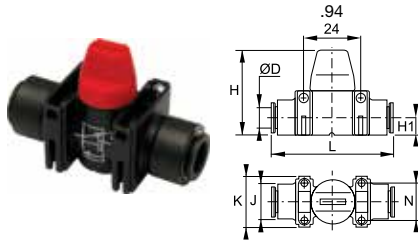

7913 – 3/2 Vented with Push-to-Connect Ports

PART NO.	ØD IN	H IN	H1 IN	J IN	K IN	L IN	N IN	W OZ
7913 04 00	5/32	1.46	.30	.59	.87	2.0	.64	.78
7913 56 00	1/4	1.46	.30	.59	.87	2.0	.64	1.45
7913 08 00	5/16	1.46	.30	.59	.87	2.0	.64	1.98
7913 60 00	3/8	1.69	.43	.79	1.18	2.6	.87	4.06

PART NO.	ØD MM	H MM	H1 MM	J MM	K MM	L MM	N MM	W KG
7913 04 00	4	37	7.5	15	22	51	16.2	0.022
7913 06 00	6	37	7.5	15	22	52	16.2	0.041
7913 08 00	8	37	7.5	15	22	52	16.2	0.056
7913 10 00	10	43	11	20	30	66	22	0.115
7913 12 00	12	43	11	20	30	66	22	0.147

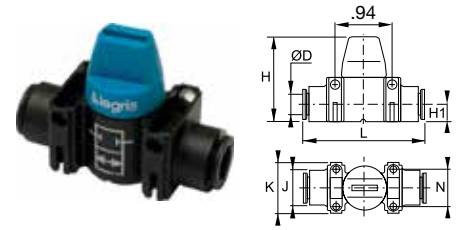

7910 – 2/2 with Push-to-Connect Ports

PART NO.	ØD IN	H IN	H1 IN	J IN	K IN	L IN	N IN	W OZ
7910 04 00	5/32	1.46	.30	.59	.87	2.01	.64	.74
7910 56 00	1/4	1.46	.30	.59	.87	2.05	.64	1.41
7910 08 00	5/16	1.46	.30	.59	.87	2.05	.64	1.94
7910 60 00	3/8	1.69	.43	.79	1.18	2.60	.64	3.95

PART NO.	ØD MM	H MM	H1 MM	J MM	K MM	L MM	N MM	W KG
7910 04 00	4	37	7.5	15	22	51	16.2	0.021
7910 06 00	6	37	7.5	15	22	52	16.2	0.040
7910 08 00	8	37	7.5	15	22	52	16.2	0.055
7910 10 00	10	43	11	20	30	66	16.2	0.112
7910 12 00	12	43	11	20	30	66	16.2	0.144

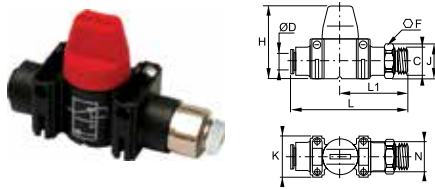

7915 – 3/2 Vented with Male Thread and Push-to-Connect Port NPT

PART NO.	ØD IN	C NPT	F MM	H IN	J IN	K IN	L IN	L1 IN	N IN	W OZ
7915 04 11	5/32	1/8	13	1.46	.55	.87	2.44	1.46	.64	1.76
7915 56 11	1/4	1/8	13	1.46	.55	.87	2.44	1.46	.64	1.90
7915 56 14	1/4	1/4	14	1.46	.59	.87	2.44	1.38	.64	2.40
7915 08 14	5/16	1/4	14	1.46	.59	1.18	2.40	1.61	.64	2.40
7915 08 18	5/16	3/8	18	1.46	.77	1.18	2.91	1.61	.64	2.82
7915 60 14	3/8	1/4	16	1.69	.69	1.18	2.40	1.65	.87	3.60
7915 60 18	3/8	3/8	18	1.69	.77	1.18	2.91	1.65	.87	4.94

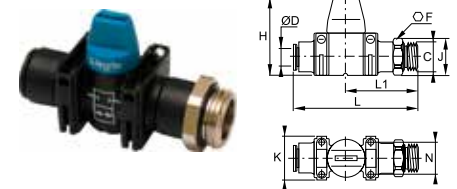

7911 – 2/2 with Male Thread and Push-to-Connect Port BSPP

PART NO.	ØD MM	C BSPP	F MM	H MM	J MM	K MM	L MM	L1 MM	N MM	W KG
7911 06 10	6	G1/8	13	37	14	22	62	37	16.2	0.052
7911 08 13	8	G1/4	16	37	17.5	22	61	35	16.2	0.066
7911 10 17	10	G3/8	20	43	22	30	74	41	16.2	0.098
7911 12 21	12	G1/2	24	43	26	30	75	42	16.2	0.129

To join the mini ball valves together, use the joining clips (7000 series).

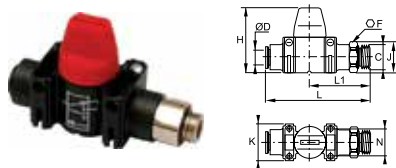

7914 – 3/2 Vented with Male Thread and Push-to-Connect Port BSPP

PART NO.	ØD MM	C BSPP	F MM	H MM	J MM	K MM	L MM	L1 MM	N MM	W KG
7914 06 10	6	G1/8	13	37	14	22	62	37	16.2	0.054
7914 08 13	8	G1/4	16	37	17.5	22	61	35	16.2	0.068
7914 10 17	10	G3/8	20	43	22	30	74	41	22	0.102
7914 12 21	12	G1/2	24	43	26	30	75	42	22	0.140

WARNING These products can expose you to chemicals including CARBON BLACK or LEAD, which are known to the state of California to cause cancer.

Ball Valves

Legris Stainless Steel



Stainless steel series ball valves can withstand corrosive fluids and environments. With full flow, high pressure and temperature capabilities, these valves are suitable for many applications.

Product Advantages:

Reliability

- Full Flow
- Excellent chemical compatibility
- High resistance to pressure/temperature
- Light series version: 100% leak-tested in production, date coding to guarantee quality and traceability

Versatility

Three in-line versions:

- One-piece: cannot be disassembled
- 3-piece: easily disassembled for maintenance and cleaning
- Light Series: for maximum compactness

Fixing Plate: 4813 and 4832

- Through-bulkhead fitting
- Pneumatic or electronic actuation (ISO 5211 standard)

Applications:

- Food Process
- Aviation
- Chemical
- Semi-Conductors
- Medical
- Petrochemical
- Laboratories
- Pharmaceutical

Specifications:

	Type 4810, 4812, 4832	Type 0465
Compatible Fluids	All fluids	All fluids
Working Pressure	0 to 943 psi (0 to 65 bar)	Vacuum to 290 psi (20 bar)
Working Temperature	-4° to 302° F (-20° to 150° C)	-4° to 248° F (-20° to 120° C)

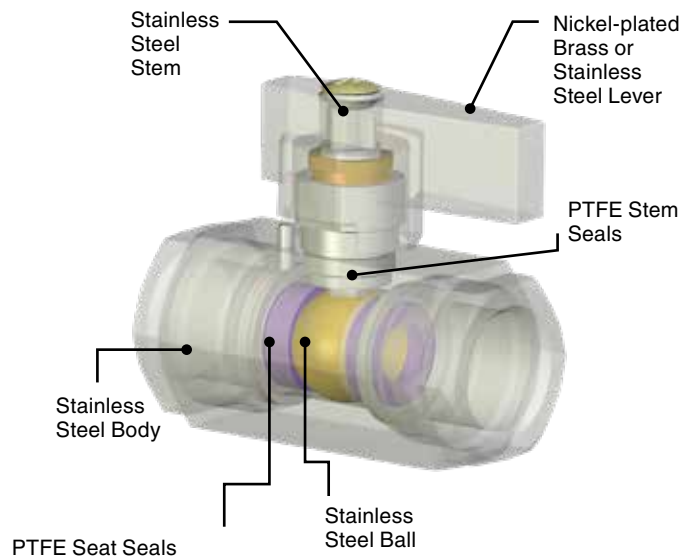

Pressure Range:

- 1/4" – 1": 2000 PSI (137.8 bar)
- 1 1/4" – 2": 1500 PSI (103.4 bar)
- Vacuum service 28 inches Hg

Temperature Range

- 0° to +400° F (-17.7° to +204.4° C)

Approvals

- Meets material requirements of NACE MR-01-75

[Click here for CADs, Product Specifications or to Configure Parts Online](#)

Stainless Steel Series Ball Valves

Stainless steel series ball valves are designed for use with corrosive fluids and in aggressive environments. Full bore, their three-piece construction allows the valve to be disassembled laterally, to facilitate maintenance. They are suitable for higher pressure and temperature applications.

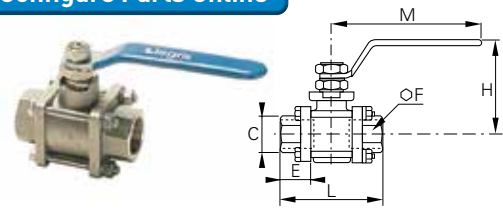

4832 – 3 Piece Double Female with Lateral Dismantling BSPP

PART NO.	C BSPP	DN	PN BAR	E MM	F MM	H MM	L MM	M MM	W KG
4832 10 13	G1/4	10	64	13	22	50	57	110	.43
4832 15 21	G1/2	15	64	15	27	65	65	130	.37
4832 20 27	G3/4	20	40	16.3	32	70	77	130	.56
4832 25 34	G1	25	40	19.1	41	79	92	170	1.04
4832 32 42	G1-1/4	32	25	21.4	50	83	106	170	1.47
4832 40 49	G1-1/2	40	25	21.4	55	100	115	250	2.00
4832 50 48	G2	50	25	25.7	70	107	136	250	3.14

Materials of Construction:

Body, Ball, Ports, Stem	Stainless Steel AISI 316
Handle, Lock Washer, Stop Pin	Stainless Steel AISI 304
Nuts, Packing Washer	Stainless Steel AISI 303
Screw	Stainless Steel AISI 305
Ball Seal, Stem Seal, Anti-friction Washer	PTFE
O-ring	FKM

Compact Stainless Steel Ball Valves

Designed for use with many aggressive and corrosive fluids at pressures not exceeding 290 psi.

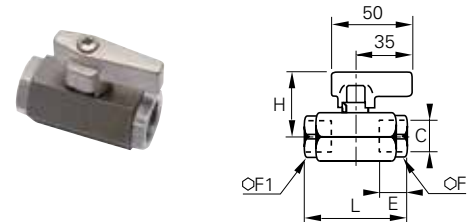

Materials of Construction:

Body, Ball, Ports, Stem	Stainless Steel AISI 18/10
Handle	Nickel-plated Brass
O-ring, Stem Seal, Ball Seal	Stainless Steel AISI 303
O-ring	PTFE

0465 Double Female Vented Ball Valve BSPP

PART NO.	C BSPP	DN	PN	E MM	F MM	F1 MM	H MM	L MM	W KG
0465 04 13	G1/4	4	30	13	19	24	36	50	.22
0465 07 17	G3/8	7	30	13	24	27	39	55	.28
0465 10 21	G1/2	10	30	16	27	30	40	62	.32

Materials of Construction:

Body, Ball, Ports, Stem	Stainless Steel AISI 316L
Handle, Lock Washer, Stop Pin	Stainless Steel AISI 304L
Nuts, Gland Seal	Stainless Steel AISI 303L
Screw	Stainless Steel AISI 305
Ball Seal, Stem Seal, Anti-friction Washer	PTFE
O-ring	FKM

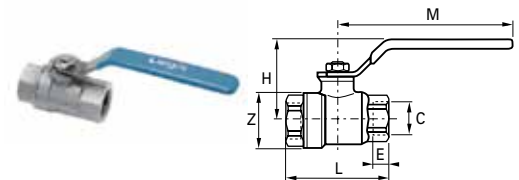

4810 Double Female BSPP

PART NO.	C BSPP	DN	BAR	PN MM	E MM	H MM	L MM	W KG
4810 08 13	G1/4	8	64	10	44.5	53.5	110.5	.22
4810 10 17	G3/8	10	64	10	44.5	53.5	110.5	.20
4810 15 21	G1/2	15	64	13	47	60	110.5	.25
4810 20 27	G3/4	20	40	14	54.5	70	131.5	.45
4810 25 34	G1	25	40	17	58.5	79	131.5	.85

WARNING These products can expose you to chemicals including CARBON BLACK or LEAD, which are known to the state of California to cause cancer.

[Click here for CADs, Product Specifications or to Configure Parts Online](#)



Ball Valves Stainless Steel Series 501SS

Product Features:

- CF-8M Stainless Steel body
- Stainless Steel ball
- PTFE Seats/Seals
- Stainless Steel handle
- Silicone Free

Material:

- SS – Stainless Steel

Options

- 20-Short Handle
- 21-Oval Handle
- 35-Welded Retainer Nut

Specifications:

Pressure Range:

- 2000 PSI (137.8 bar)
- Vacuum service 28 inches Hg

Temperature Range

- 0° to +400° F (-17.7° to +204.4° C)

Style:

- V-Valve

Type:

- 501-Male/Female NPT Ports

Approvals

- Meets material requirements of NACE MR-01-75

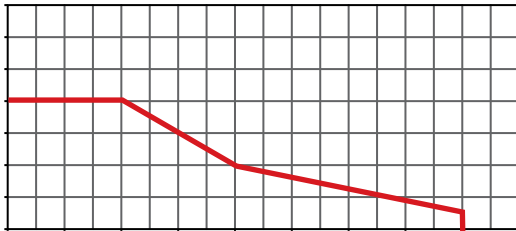

FLOW DATA	
VALVE SIZE	CV
1/4	4.0
3/8	6.0
1/2	14.0
3/4	35.0
1	54.0

Mounting Detail

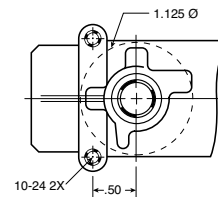

Male-Female Pipe Ends V501SS

PART NO.	PIPE THREAD (NPT)	HEX	F	G	L	M	N	D FLOW Ø
V501SS-4	1/4	15/16	.50	1.12	5.60	2.65	1.97	.280
V501SS-6	3/8	15/16	.50	1.12	5.60	2.65	1.97	.375
V501SS-8	1/2	1-1/16	.50	1.12	5.85	3.05	2.00	.500
V501SS-12	3/4	1-3/8	.88	1.37	7.27	3.85	2.55	.720
V501SS-16	1	1-5/8	.88	1.37	7.48	4.25	2.68	.940

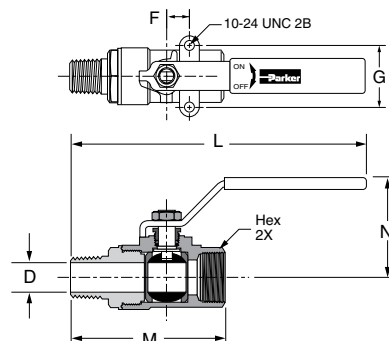

WARNING These products can expose you to chemicals including CARBON BLACK or LEAD, which are known to the state of California to cause cancer.

[Click here for CADs, Product Specifications or to Configure Parts Online](#)

Ball Valves

Stainless Steel Series 502SS

Product Features:

- CF-8M Stainless Steel body
- Stainless Steel ball
- PTFE Seats/Seals
- Stainless Steel handle
- Silicone Free

Style:

- V-Valve
- VP-Valve, Padlocking

Type:

- 502-Panel Mount Female/
Female NPT Ports

Material:

- SS – Stainless Steel

Options

- 20-Short Handle
- 21-Oval Handle
- 35-Welded Retainer Nut

Specifications:

Pressure Range:

- 1/4" – 1": 2000 PSI (137.8 bar)
- 1 1/4" – 2": 1500 PSI (103.4 bar)
- Vacuum service 28 inches Hg

Temperature Range

- 0° to +400° F (-17.7° to +204.4° C)

Approvals

- Meets material requirements of NACE MR-01-75

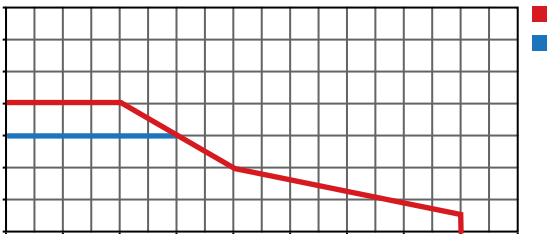

FLOW DATA		MOUNTING HOLE DIAMETER	
VALVE SIZE	CV	VALVE SIZE	DIA. IN.
1/4	4.0	1/4	1.125
3/8	6.0	3/8	1.125
1/2	14.0	1/2	1.125
3/4	35.0	3/4	1.500
1	54.0	1	1.500
1 1/4	74.0	1 1/4	1.875
1 1/2	120.0	1 1/2	1.875
2	226.0	2	1.875

Mounting Detail

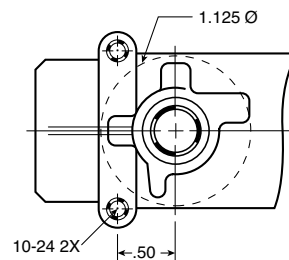

Note: Periodically check the adjustable packing nut and tighten as required.

WARNING These products can expose you to chemicals including CARBON BLACK or LEAD, which are known to the state of California to cause cancer.

[Click here for CADs, Product Specifications or to Configure Parts Online](#)

Female Pipe Ends, Panel Mount V502SS

PART NO.	PIPE THD (NPT)	B/C HEX	F	G	H	I THREAD	L	M	N	PANEL FLOW DIA. D	HOLE DIA.
V502SS-4	1/4	15/16	.500	1.125	4.00	10-24 UNC	5.03	2.07	2.52	.380	1.125
V502SS-6	3/8	15/16	.500	1.125	4.00	10-24 UNC	5.03	2.07	2.52	.380	1.125
V502SS-8	1/2	1-1/16	.500	1.125	4.00	10-24 UNC	5.13	2.27	2.65	.500	1.125
V502SS-12	3/4	1-3/8	.875	1.375	5.00	10-24 UNC	6.67	3.35	3.46	.790	1.500
V502SS-16	1	1-5/8	.875	1.375	5.00	10-24 UNC	6.77	3.54	3.74	1.000	1.500
V502SS-20	1-1/4	2	1.000	1.500	7.00	1/4-20 UNC	9.00	4.00	4.55	1.250	2.000
V502SS-24	1-1/2	2-3/8	1.000	1.500	7.00	1/4-20 UNC	7.19	4.38	5.42	1.500	2.000
V502SS-32	2	3	1.000	1.500	7.00	1/4-20 UNC	9.75	5.50	5.68	2.000	2.000

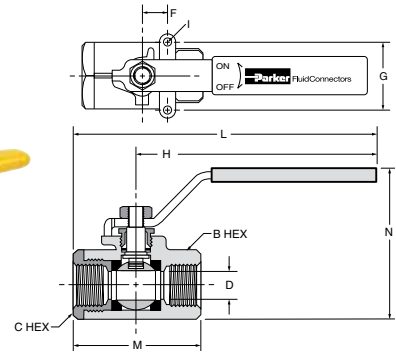

Short Handle, Female Pipe Ends, Panel Mount V502SS-X-20

PART NO.	PIPE THREAD [NPT]	B/C HEX	G	H	L	M	N	FLOW DIA. D
V502SS-4-20	1/4	15/16	1.12	2.28	3.32	2.07	2.53	.375
V502SS-6-20	3/8	15/16	1.12	2.28	3.32	2.07	2.53	.375
V502SS-8-20	1/2	1-1/16	1.12	2.22	3.37	2.25	2.63	.500

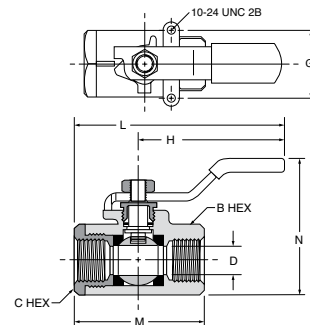

Locking Handle, Female Pipe Ends, Panel Mount VP502SS

PART NO.	PIPE THD (NPT)	B/C HEX	F	G	H	I THREAD	L	M	N	PANEL FLOW DIA. D	HOLE DIA.
VP502SS-4	1/4	15/16	.500	1.125	4.00	10-24 UNC	5.03	2.07	2.52	.380	1.125
VP502SS-6	3/8	15/16	.500	1.125	4.00	10-24 UNC	5.03	2.07	2.52	.380	1.125
VP502SS-8	1/2	1-1/16	.500	1.125	4.00	10-24 UNC	5.13	2.27	2.65	.500	1.125
VP502SS-12	3/4	1-3/8	.875	1.375	5.00	10-24 UNC	6.67	3.35	3.46	.790	1.500
VP502SS-16	1	1-5/8	.875	1.375	5.00	10-24 UNC	6.77	3.54	3.74	1.000	1.500
VP502SS-20	1-1/4	2	1.000	1.500	7.00	1/4-20 UNC	9.00	4.00	4.55	1.250	2.000
VP502SS-24	1-1/2	2-3/8	1.000	1.500	7.00	1/4-20 UNC	7.19	4.38	5.42	1.500	2.000
VP502SS-32	2	3	1.000	1.500	7.00	1/4-20 UNC	9.75	5.50	5.68	2.000	2.000

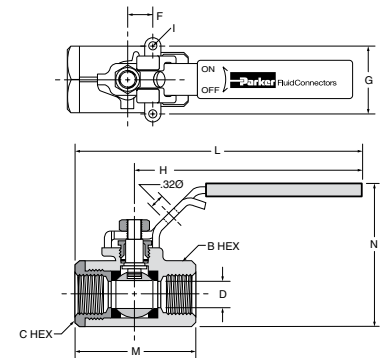

Oval Handle, Female Pipe Ends, Panel Mount V502SS-X-21

PART NO.	PIPE THD (NPT)	B/C HEX	G	H	L	I THREAD	M	N	PANEL FLOW DIA. D	HOLE DIA.
V502SS-4-21	1/4	15/16	1.125	1.74	3.48	10-24 UNC	2.07	2.43	.380	1.125
V502SS-6-21	3/8	15/16	1.125	1.74	3.48	10-24 UNC	2.07	2.43	.380	1.125
V502SS-8-21	1/2	1-1/16	1.125	1.74	3.48	10-24 UNC	2.27	2.54	.500	1.125
V502SS-12-21	3/4	1-3/8	1.375	2.68	5.36	10-24 UNC	3.35	3.45	.790	1.500
V502SS-16-21	1	1-5/8	1.375	2.68	5.36	10-24 UNC	3.54	3.74	1.000	1.500

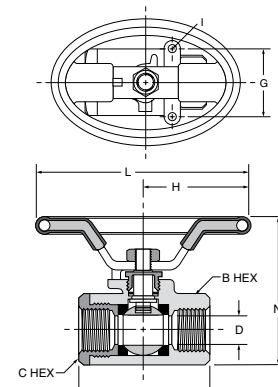

WARNING These products can expose you to chemicals including CARBON BLACK or LEAD, which are known to the state of California to cause cancer.



Polypropylene Ball Valves LIQUIfit

This range of valves offers an innovative solution in the treatment of water and the handling of beverages. LIQUIfit's corrosion-resistant, all plastic design make them ideal for water filtration units, coffee and beverage machines and a wide variety of other fluid applications.

Product Features:

- Stainless steel gripping ring
- Polypropylene body
- EPDM D-seal
- Full flow self cleaning ball maintains the cleanliness of the circuit
- Gripping ring technology prevents pumping effect
- FDA, NSF 51, NSF 61
- 100% leak tested in production
- Date coded for lot traceability

Markets:

- Water Filtration
- Beverage Dispensing
- Life Science
- Bottling
- Semi-Conductor

Applications:

- Water
- Beverages
- Food
- CO₂

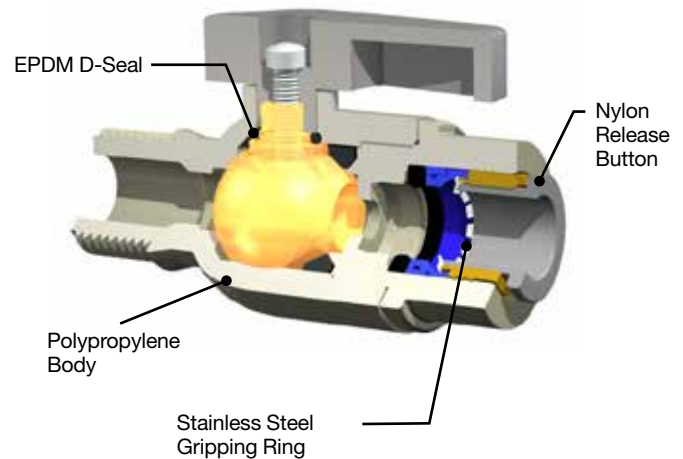

Specifications:

Pressure Range Up to 230 psi (16 bar)

Temperature Range 35° to 200° F (1° to 93° C)

Note: Maximum working pressure and temperature are dependent on the type of tubing used

Compatible Tubing:

- Polyethylene



[Click here for CADs, Product Specifications or to Configure Parts Online](#)



**VUC – Valve Union Connector
Fractional Inch Tube to Tube**

PART NO.	ØD1 IN	ØD2 IN	A IN	B IN	C IN	D IN	ØE IN	W OZ
LFPP4VUC4	1/4	1/4	2.55	1.22	1.0	.5	.19	1.12
LFPP4VUC6	1/4	3/8	2.57	1.30	1.0	.5	.19	1.18
LFPP6VUC6	3/8	3/8	2.67	1.32	1.4	.5	.25	1.24

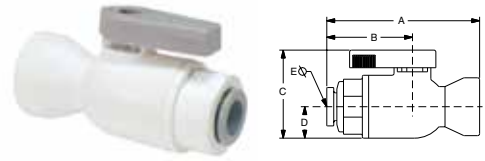

**VUC – Valve Union Connector
Metric Tube to Tube**

PART NO.	ØD1 MM	ØD2 MM	A MM	B MM	C MM	D MM	ØE MM	W KG
LFPP6MVUC6M	6	6	.57	.27	.36	.13	.19	.019
LFPP8MVUC8M	8	8	.60	.27	.36	.13	.25	.020
LFPP10MVUC10M	10	10	.70	.33	.36	.13	.33	.023
LFPP12MVUC12M	12	12	.88	.43	.36	.13	.37	.034

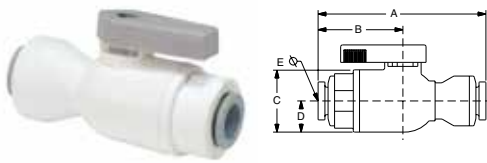

**VFC – Valve Female Connector
Fractional Inch Tube to NPTF**

PART NO.	ØD IN	NPTF THREAD	A IN	B IN	C IN	D IN	ØE IN	W OZ
LFPP4VFC2	1/4	1/8	2.55	1.22	1.0	.5	.19	1.07
LFPP4VFC4	1/4	1/4	2.57	1.30	1.0	.5	.19	1.09
LFPP4VFC6	1/4	3/8	2.67	1.32	1.4	.5	.25	1.08
LFPP6VFC2	3/8	1/8	2.55	1.22	1.0	.5	.19	1.12
LFPP6VFC4	3/8	1/4	2.57	1.30	1.0	.5	.19	1.14
LFPP6VFC6	3/8	3/8	2.67	1.32	1.4	.5	.25	1.14

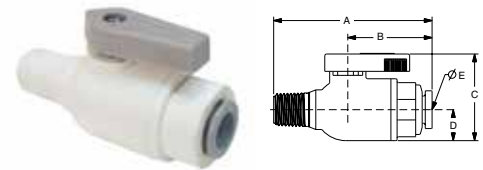

**VMC – Valve Male Connector
Fractional Inch Tube to NPTF**

PART NO.	ØD IN	NPTF THREAD	A IN	B IN	C IN	D IN	ØE IN	W OZ
LFPP4VMC2	1/4	1/8	2.22	1.21	1.4	.5	.19	1.09
LFPP4VMC4	1/4	1/4	2.40	1.21	1.4	.5	.19	1.08
LFPP4VMC6	1/4	3/8	2.40	1.21	1.4	.5	.19	1.07
LFPP4VMC8	1/4	1/2	2.59	1.21	1.4	.5	.19	1.08
LFPP6VMC2	3/8	1/8	2.33	1.32	1.4	.5	.25	1.14
LFPP6VMC4	3/8	1/4	2.51	1.32	1.4	.5	.25	1.14
LFPP6VMC6	3/8	3/8	2.51	1.32	1.4	.5	.25	1.14
LFPP6VMC8	3/8	1/2	2.70	1.32	1.4	.5	.25	1.14

WARNING These products can expose you to chemicals including CARBON BLACK or LEAD, which are known to the state of California to cause cancer.

Click here for CADs, Product Specifications or to Configure Parts Online

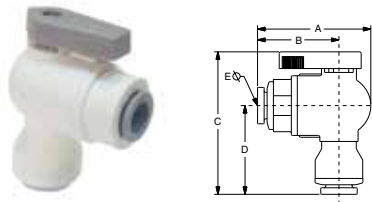

**VEU – Valve Elbow Union
Fractional Inch Tube to Tube**

PART NO.	ØD1 IN	ØD2 IN	A IN	B IN	C IN	D IN	ØE IN	W OZ
LFPP4VEU4	1/4	1/4	1.75	1.22	2.33	1.42	.19	1.17
LFPP4VEU6	1/4	3/8	1.75	1.22	2.33	1.42	.11	1.21
LFPP6VEU4	3/8	1/4	1.83	1.30	2.32	1.40	.19	1.21
LFPP6VEU6	3/8	3/8	1.85	1.32	2.34	1.44	.25	1.24

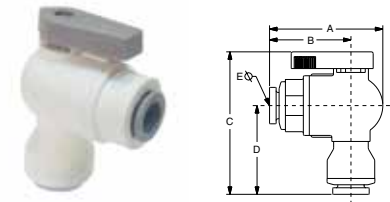

**VEU – Valve Elbow Union
Metric Tube to Tube**

PART NO.	ØD1 MM	ØD2 MM	A MM	B MM	C MM	D MM	ØE MM	W KG
LFPP6MVEU6M	6	6	.41	.27	.55	.31	.19	.033
LFPP8MVEU8M	8	8	.41	.28	.56	.33	.25	.034
LFPP10MVEU10M	10	10	.48	.33	.61	.38	.33	.034

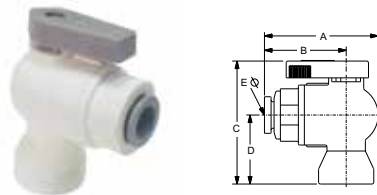

**VFE – Valve Female Elbow
Fractional Inch Tube to NPTF**

PART NO.	ØD IN	NPTF THREAD	A IN	B IN	C IN	D IN	ØE IN	W OZ
LFPP4VFE2	1/4	1/8	1.74	1.21	1.82	.92	.19	1.08
LFPP4VFE4	1/4	1/4	1.74	1.21	2.05	1.15	.19	1.09
LFPP4VFE6	1/4	3/8	1.74	1.21	2.18	1.28	.19	1.07
LFPP6VFE2	3/8	1/8	1.85	1.32	1.82	.92	.25	1.14
LFPP6VFE4	3/8	1/4	1.85	1.32	2.05	1.15	.25	1.14
LFPP6VFE6	3/8	3/8	1.85	1.32	2.18	1.28	.25	1.24

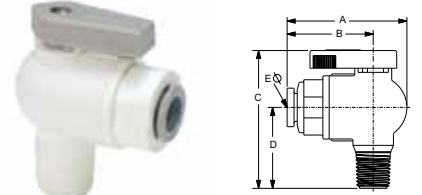

**VME – Valve Male Elbow
Fractional Inch Tube to NPTF**

PART NO.	ØD IN	NPTF THREAD	A IN	B IN	C IN	D IN	ØE IN	W OZ
LFPP4VME2	1/4	1/8	1.74	1.21	2.00	1.10	.19	1.09
LFPP4VME4	1/4	1/4	1.74	1.21	2.18	1.28	.19	1.09
LFPP4VME6	1/4	3/8	1.74	1.21	2.18	1.28	.19	1.08
LFPP4VME8	1/4	1/2	1.74	1.21	2.37	1.47	.19	1.08
LFPP6VME2	3/8	1/8	1.85	1.32	2.00	1.10	.25	1.14
LFPP6VME4	3/8	1/4	1.85	1.32	2.18	1.28	.25	1.14
LFPP6VME6	3/8	3/8	1.85	1.32	2.18	1.28	.25	1.14
LFPP6VME8	3/8	1/2	1.85	1.32	2.37	1.47	.25	1.24

WARNING These products can expose you to chemicals including CARBON BLACK or LEAD, which are known to the state of California to cause cancer.



Polypropylene Ball Valves TrueSeal™

Parker's TrueSeal Ball Valves offer proven leak-free performance. Their corrosion-resistant, all-plastic design makes them ideal for water filtration units, coffee and beverage machines and a wide variety of other fluid applications. Polypropylene material meets all FDA and NSF-51 requirements for food contact.

Product Features:

- Precision molded, all-plastic design is leak free and corrosion resistant.
- Polypropylene material offers a wider chemical acceptance range, as well as a wide temperature range.
- Bi-directional flow maximizes productivity.
- Full flow design reduces pressure drop across the valve.
- Special o-ring seal ensures a reliable leak-tight connection.
- TrueSeal™ connection reduces potential leaks.

Specifications:

- Temperature range: 0° F to +225° F (-18° C to +107° C).
- O-ring seal material: EPDM.
- NSF/ANSI 51 listed.
- Pressure rated to 150 PSI (10.3 bar) with a 600 PSI (41.4 bar) burst pressure. Actual working pressures will be lower at elevated temperatures.

Advantages:

- Reduce costs – Built-in TrueSeal™ connection eliminates the need for a secondary fitting.
- Save space – Low-profile design allows for easy assembly and access where space is at a premium.

Assembly Instructions

1. Inspect the mating threads for debris or damage. Remove any old fluoropolymer tape or sealant on previously used threads. If threads are damaged, replace with new adapter before proceeding.
2. Apply 2 to 3 wraps of fluoropolymer tape, or an NSF/FDA approved silicon sealant. Do not use Plumbers Putty or Pipe Dope. These chemically react with plastic materials and could cause a failure.
3. Align ball valve to mating thread to ensure cross threading does not occur.
4. Screw ball valve onto mating thread 3 to 5 turns.
5. This should be sufficient to properly seal the threads.

tube SIZE	o.d. Tolerance	Insertion depth
5/32	±.005	9/16
1/4	±.005	11/16
5/16	±.005	13/16
3/8	±.005	3/4
1/2	±.005	7/8

Click here for CADs, Product Specifications or to Configure Parts Online

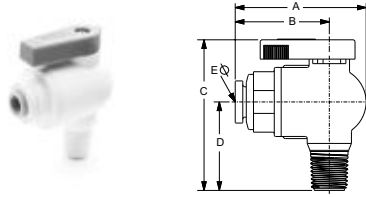

VME – Valve Male Elbow Fractional Inch to NPTF

PART NO.	ØD IN	NPTF THREAD	A IN	B IN	C IN	D IN	ØE IN
PP4VME2-MG (+)	1/4	1/8	1.74	1.21	2.00	1.10	.19
PP4VME4-MG	1/4	1/4	1.74	1.21	2.18	1.28	.19
PP4VME6-MG	1/4	3/8	1.74	1.21	2.18	1.28	.19
PP4VME8-MG (+)	1/4	1/2	1.74	1.21	2.37	1.47	.19
PP6VME2-MG (+)	3/8	1/8	1.85	1.32	2.00	1.10	.25
PP6VME4-MG	3/8	1/4	1.85	1.32	2.18	1.28	.25
PP6VME6-MG	3/8	3/8	1.85	1.32	2.18	1.28	.25
PP6VME8-MG	3/8	1/2	1.85	1.32	2.37	1.47	.25

(+) For nonstandard plastic collet, remove -MG suffix.

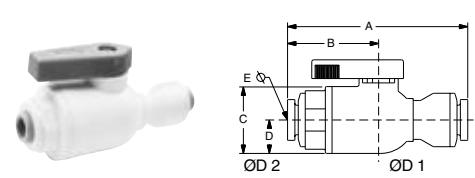

VUC – Valve Union Connector Fractional Inch Tube

PART NO.		ØD1 IN	ØD2 IN	A IN	B IN	C IN	D IN	ØE IN
BLACK PPL	WHITE PPL							
PPB4VUC4-MG	PP4VUC4-MG	1/4	1/4	2.55	1.22	1.0	.5	.19
	PP4VUC6-MG	1/4	3/8	2.55	1.22	1.0	.5	.19
	PP6VUC4-MG	3/8	1/4	2.57	1.30	1.0	.5	.19
PPB6VUC6-MG	PP6VUC6-MG	3/8	3/8	2.57	1.32	1.4	.5	.25

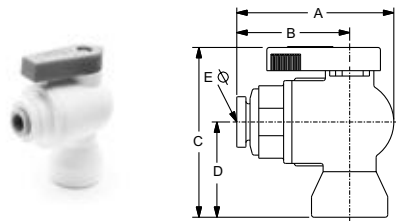

VFE – Valve Female Elbow Fractional Inch to NPTF

PART NO.	ØD IN	NPTF THREAD	A IN	B IN	C IN	D IN	ØE IN
PP4VFE2-MG (+)	1/4	1/8	1.74	1.21	1.82	.92	.19
PP4VFE4-MG	1/4	1/4	1.74	1.21	2.05	1.15	.19
PP4VFE6-MG	1/4	3/8	1.74	1.21	2.18	1.28	.19
PP6VFE2-MG (+)	3/8	1/8	1.85	1.32	1.82	.92	.25
PP6VFE4-MG	3/8	1/4	1.85	1.32	2.05	1.15	.25
PP6VFE6-MG	3/8	3/8	1.85	1.32	2.18	1.28	.25

(+) For nonstandard plastic collet, remove -MG suffix.

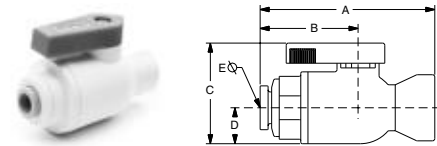

VFC – Valve Female Connector Fractional Inch Tube to NPTF

PART NO.		ØD1 IN	NPTF THREAD	A IN	B IN	C IN	D IN	ØE IN
BLACK PPL	WHITE PPL							
	PP4VFC2-MG	1/4	1/8	2.04	1.21	1.4	.5	.19
	PP4VFC4-MG	1/4	1/4	2.27	1.21	1.4	.5	.19
	PP4VFC6-MG	1/4	3/8	2.40	1.21	1.4	.5	.19
	PP6VFC2-MG	3/8	1/8	2.15	1.32	1.4	.5	.25
	PP6VFC4-MG	3/8	1/4	2.38	1.32	1.4	.5	.25
PPB6VFC6-MG	PP6VFC6-MG	3/8	3/8	2.51	1.32	1.4	.5	.25

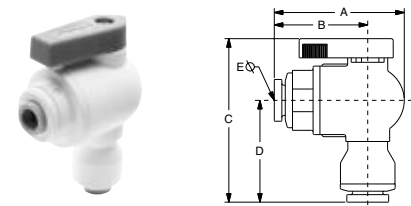

VEU – Valve Elbow Union Fractional Inch

PART NO.	ØD1 IN	ØD2 IN	A IN	B IN	C IN	D IN	ØE IN
PP4VEU4-MG	1/4	1/4	1.75	1.22	2.33	1.42	.19
PP4VEU6-MG	1/4	3/8	1.75	1.22	2.33	1.42	.19
PP6VEU4-MG	3/8	1/4	1.83	1.30	2.32	1.40	.19
PP6VEU6-MG	3/8	3/8	1.83	1.32	2.34	1.44	.25

WARNING These products can expose you to chemicals including CARBON BLACK or LEAD, which are known to the state of California to cause cancer.

[Click here for CADs, Product Specifications or to Configure Parts Online](#)

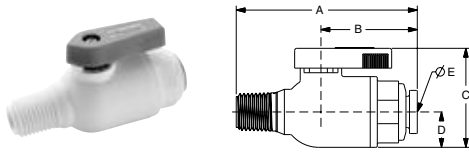

VMC Valve Male Connector Fractional Inch to NPTF

PART NO.	ØD IN	NPTF THREAD	A IN	B IN	C IN	D IN	ØE IN
PP4VMC2-MG (+)	1/4	1/8	2.22	1.21	1.4	.5	.19
PP4VMC4-MG	1/4	1/4	2.40	1.21	1.4	.5	.19
PP4VMC6-MG	1/4	3/8	2.40	1.21	1.4	.5	.19
PP4VMC8-MG (+)	1/4	1/2	2.59	1.21	1.4	.5	.19
PP6VMC2-MG (+)	3/8	1/8	2.33	1.32	1.4	.5	.25
PP6VMC4-MG	3/8	1/4	2.51	1.32	1.4	.5	.25
PP6VMC6-MG	3/8	3/8	2.51	1.32	1.4	.5	.25
PP6VMC8-MG (+)	3/8	1/2	2.70	1.32	1.4	.5	.25

(+) For nonstandard plastic collet, remove -MG suffix.

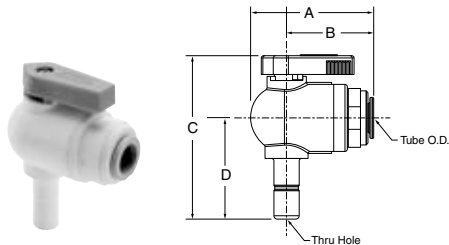

VTEU Valve Male Connector Fractional Inch to NPTF

PART NO.	ØD IN	STEM IN	A IN	B IN	C IN	D IN	ØE IN
PP4VTEU6-MG	1/4	3/8	1.75	1.22	2.43	1.50	.17
PP6VTEU6-MG	3/8	3/8	1.83	1.30	2.43	1.50	.25



SC Safety Clip

PART NO.	PART NO.	ØD IN
SC-4	SC-4-B	1/4
SC-5	SC-5-B	5/16
SC-6	SC-6-B	3/8
SC-8	SC-8-B	1/2

(Patent No. 6,065,779)



TS Tube Supports

PART NO.	
NYLON	PPL
N4TS3	P4TS3
N5TS3	P4TS3
N6TS4	P6TS4
N8TS6	P8TS6

To be used with soft durometer tubing.



AQRT – Quick Release Tool

Makes disconnection of tube adapters and tubing a breeze.

WARNING These products can expose you to chemicals including CARBON BLACK or LEAD, which are known to the state of California to cause cancer.



Polypropylene Ball Valves Par-Barb

Parker's Par-Barb Ball Valves are injection molded from high strength chemically inert, thermoplastic materials. The multiple barb design generates the maximum gripping and sealing power when combined with a hose clamp.

Product Features:

- Available in black polypropylene and white nylon
- FDA compliant material
- NSF/ANSI 51
- Uniprene washer
- Up to 1 1/2" sizes

Markets:

- Water
- Beverage Dispensing
- Bottling
- Semi-Conductor

Applications:

- Water
- Beverages
- Cooling Systems

Specifications:

Pressure Range Up to 125 PSI (8.6 bar)

Temperature Range Nylon: -40° to +200° F (-40° to +93.3° C)
Polypropylene: +10° to +220° F (-12.2° to +104.4° C)

Compatible Tubing:

- Vinyl
- Polyurethane
- Rubber hose

[Click here for CADs, Product Specifications or to Configure Parts Online](#)

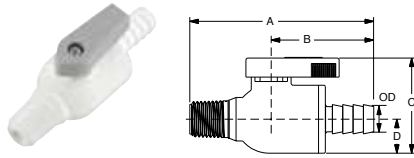

**VMC – Valve Male Connector
Fractional Inch Barb To NPTF**

PART NO.	ID IN	NPTF THREAD	ØD IN	A IN	B IN	C IN	D IN	ØE IN
PBPP4VMC4	1/4	1/4	.31	2.79	1.60	1.42	.50	.15
PBPP6VMC6	3/8	3/8	.43	2.79	1.60	1.42	.50	.19

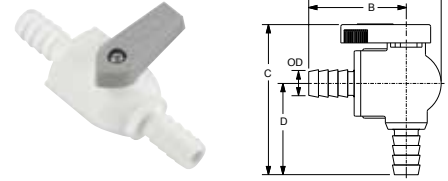

**VEU – Valve Parbarb Elbow
Fractional Inch Barb To Barb**

PART NO.	ID IN	ØD IN	A IN	B IN	C IN	D IN	ØE IN
PBPP4VEU4	1/4	.31	2.13	1.57	2.32	1.40	.15
PBPP6VEU6	3/8	.43	2.13	1.60	2.32	1.40	.25
PBPP8VEU8	1/2	.55	2.13	1.60	2.32	1.40	.25

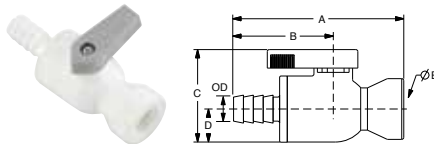

**VFC – Valve Female Connector
Fractional Inch Barb to NPTF**

PART NO.	ID IN	NPTF THREAD	ØD IN	A IN	B IN	C IN	D IN	ØE IN
PBPP4VFC4	1/4	1/4	.31	2.76	1.60	1.41	.50	.15
PBPP6VFC6	3/8	3/8	.43	2.79	1.60	1.41	.50	.19

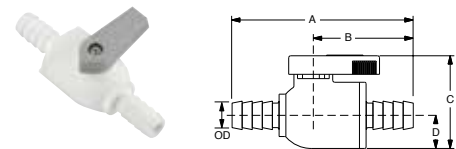

**VUC – Valve Union Connector
Fractional Inch Barb To Barb**

PART NO.	ID IN	ØD IN	A IN	B IN	C IN	D IN	ØE IN
PBPP4VUC4	1/4	.31	2.91	1.60	1.42	.50	.15
PBPP6VUC6	3/8	.43	2.91	1.60	1.42	.50	.19
PBPP8VUC8	1/2	.55	2.91	1.60	1.42	.50	.25

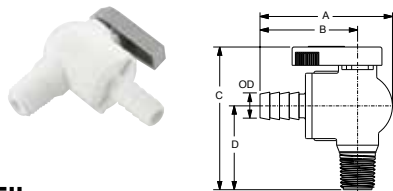

**VME – Valve Male Elbow
Fractional Inch Barb to NPTF**

PART NO.	ID IN	NPTF THREAD	ØD IN	A IN	B IN	C IN	D IN	ØE IN
PBPP4VME4	1/4	1/4	.31	2.13	1.60	2.18	1.28	.15
PBPP6VME6	3/8	3/8	.43	2.13	1.60	2.18	1.28	.19

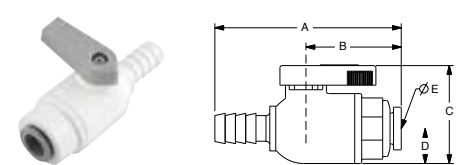

**VUCPB – Valve Union Connector
Fractional Inch Tube To Barb**

PART NO.	ID IN	TUBE ØD IN	ØD IN	A IN	B IN	C IN	D IN	ØE IN
LFPP4VUCPB4	1/4	1/4	.31	2.40	1.08	1.42	.50	.15
LFPP6VUCPB6	3/8	3/8	.43	2.63	1.32	1.42	.50	.19

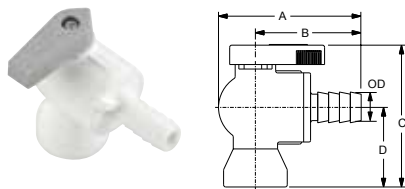

**VFE – Valve Female Elbow
Fractional Inch Barb To NPTF**

PART NO.	ID IN	NPTF THREAD	ØD IN	A IN	B IN	C IN	D IN	ØE IN
PBPP4VFE4	1/4	1/4	.31	2.13	1.60	2.05	1.15	.15
PBPP6VFE4	3/8	1/4	.43	2.13	1.60	2.05	1.15	.15
PBPP6VFE6	3/8	3/8	.43	2.13	1.60	2.18	1.28	.19

BVC Ball Valve Clip

BV-Clip Shown below holding VUCPB and VME

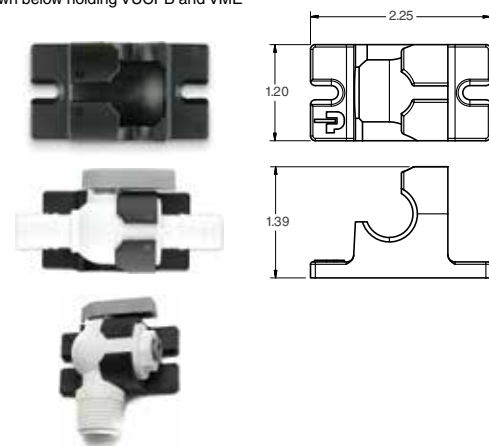

WARNING These products can expose you to chemicals including CARBON BLACK or LEAD, which are known to the state of California to cause cancer.



Axial Valves

The Parker Legris axial valve is the only valve to incorporate both the valve and actuation function. With pneumatic or electro-pneumatic control, it avoids many of the restrictions associated with traditional actuators.

Product Advantages:

Optimization & Safety

- Very compact: up to 50% smaller than valves with separate actuators
- Simple to install: ready-to-use
- Common sub-base for solenoid control
- Automation of the open/close function
- Operation independent of the upstream and downstream pressure in the circuit

Performance

- Full flow: low pressure drop
- Excellent pressure/temperature performance
- Compatible with many industrial fluids

Applications:

- Flow Control
- Plastic Injection Molding
- Rubber Industry
- Pneumatics
- Textile
- Printing
- Packaging
- Robotics

Specifications:

Working Pressure 150 psi (10 bar)

Working Temperature -4° to 275° F (20° to 135° C)

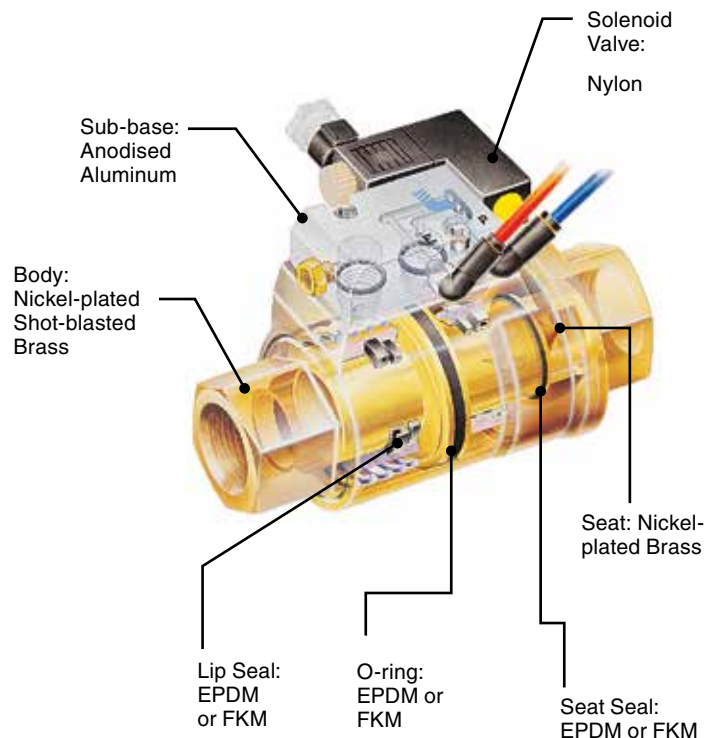

Operation

Depending on operational requirement, air is passed into the actuation chamber to open or close the valve.

Normally Closed Axial Valve (NC)

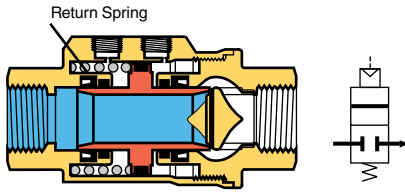

Rest State (Valve Closed)

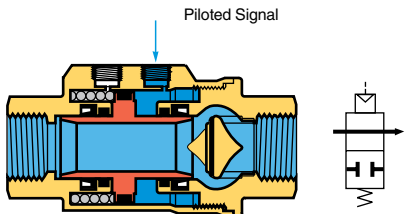

Piloted State (Valve Open)

Normally Open Axial Valve (NO)

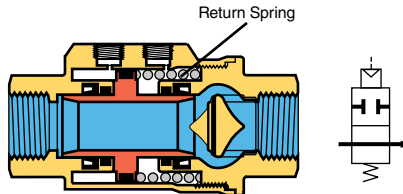

Rest State (Valve Open)

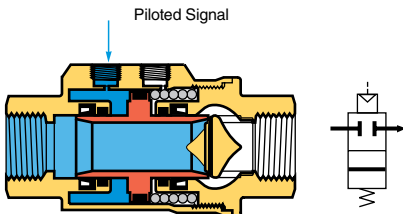

Piloted State (Valve Closed)

Double-Acting Axial Valve (DE)

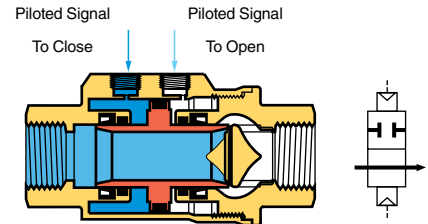

Piloted State (Valve Closed)

Installation Options

Parker Legris' axial valve offers 3 different control methods dependant on the requirements of the installation:

Pneumatic Control

Example: Double-acting axial valve 4222

- Local compressed air control
- For repetitive on/off cycles
- Remote control where access to the machine is difficult
- For explosive or explosion prevention areas

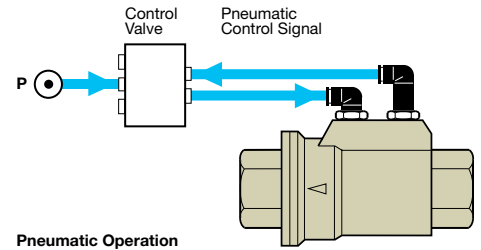

Electro-Pneumatic Control

Example: Normally closed axial valve 4203

- Sub-base and mini-solenoid valve 4298
- For automated industrial systems requiring remote control
- Namur seating plane solenoid valve

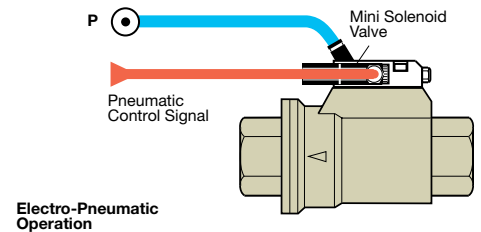

Dual Pneumatic and Electro-Pneumatic Control

Example: Normally open axial valve 4212

- Sub-base and mini-solenoid valve 4298
- Pneumatic push-button 4299
- Dual control structure
- For increased safety: prevents localised operating errors
- Namur seating plane solenoid valve

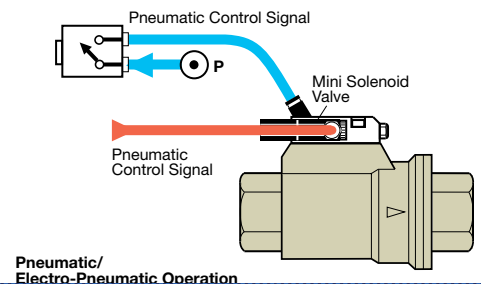

Click here for CADs, Product Specifications or to Configure Parts Online

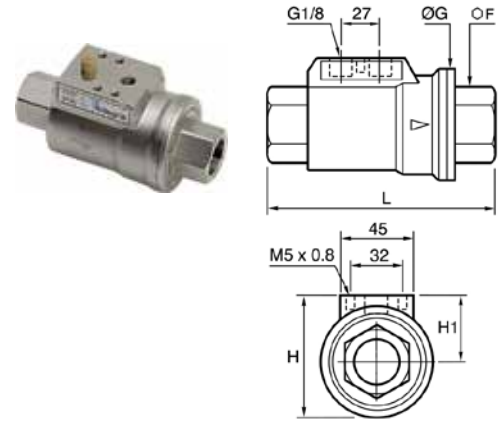
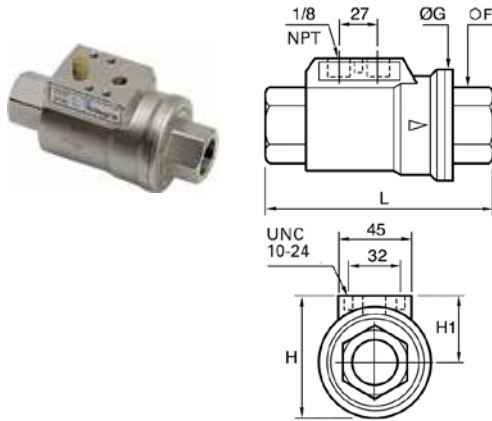

4203 Normally Closed, Double Female NPT

PART NO.	C NPT	DN	FKM SEAL	F MM	G IN	H IN	H1 IN	W LB
4203 10 18 20	3/8	10	22	1.81	2.12	1.21	3.60	1.79
4203 15 22 20	1/2	15	27	2.03	2.33	1.31	4.13	2.39
4203 20 28 20	3/4	20	33	2.50	2.76	1.51	4.92	3.60
4203 40 50 20	1 1/2	40	60	3.78	4.01	2.12	6.67	9.22
4203 50 44 20	2	50	75	4.29	4.50	2.35	7.39	14.02

Pilot port: 1/8 - 27 NPT
Complete with 1/8 NPT silencer

4202 Normally Closed, Double Female BSPP

PART NO.	C BSPP	DN	FKM SEAL	F MM	G MM	H MM	H1 MM	W KG
4202 10 17 20	G3/8	10	22	46	54	31	98	.814
4202 15 21 20	G1/2	15	27	52	60	35	112	1.085
4202 20 27 20	G3/4	20	33	64	70	38	135	1.634
4202 25 34 20	G1	25	41	69	76	41.5	143	2.024
4202 32 42 20	G1 1/4	32	50	86	91	48	165	3.301
4202 40 49 20	G1 1/2	40	60	96	102	54	180	4.180
4202 50 48 20	G2	50	75	109	115	60.5	207	6.360

Pilot port: 1/8 BSPP
Complete with 1/8 BSPT silencer

Upon special request, we can supply:

- Normally open and double acting valves
- Replacement seal kits (FKM, Nitrile)
- Axial valves equipped with magnetic sensors to indicate their state (open and/or closed)
- Chemically nickel-plated axial valves

⚠ WARNING These products can expose you to chemicals including CARBON BLACK or LEAD, which are known to the state of California to cause cancer.

[Click here for CADs, Product Specifications or to Configure Parts Online](#)

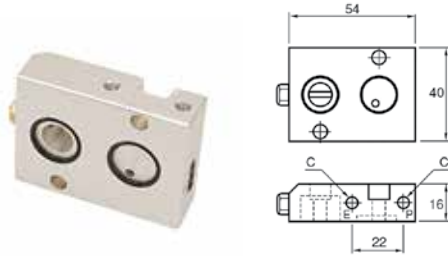

4298 Subbase for Solenoid Pilot Valve M5

PART NO.	C	W OZ
4298 00 01	M5X0.8	3.35

Sub-base conforms to NAMUR specifications. The sub-base is fitted directly to the axial valve and permits the mounting of a mini solenoid valve.

Supplied with two fixing bolts and silencer.



4298 Mini-Solenoid Valve 1W/1.2VA

PART NO.	VOLTAGE	W OZ
4298 01 01	24V	DC
4298 01 02	24V	AC
4298 02 01	110V	AC
4298 02 02	220V	AC

type of coil	voltage	power class	insulation degree	protection	cable entry	
size 15	~	24-110-220V - 50/60 Hz	2W	F	IP 65	plug size 15 rotatable through 90° - CM 6
	=	24V	1W			



4299 Pneumatic Button

PART NO.	1 PNEUMATIC CONTACT	W OZ
4299 01 01	STANDARD	3.17
4299 01 02	WITH KEY	3.88

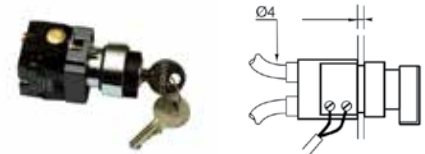

4299 Electro-Pneumatic

PART NO.	1 ELECTRO-PNEUMATIC CONTACT	W OZ
4299 02 01	STANDARD	3.60

Bulkhead fixing hole diameter: 22mm

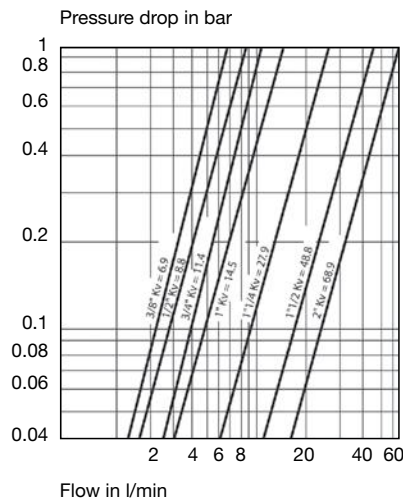

Flow curve / Pressure drop / Kv

Kv in l/min

(water at ambient temperature, under a differential pressure of one bar)

WARNING These products can expose you to chemicals including CARBON BLACK or LEAD, which are known to the state of California to cause cancer.



Accessories

Blow Guns

Silencers

Sealing Accessories & Plugs

Bins



For Bins information visit:
www.parker.com/bins



GOODYEAR
RUBBER PRODUCTS, INC.

☎ 727-342-5088

You can also email us at
GRP@goodyearrubberproducts.com

Blow Guns

0659

Standard Blowgun
NPT
p. L6



0659

Standard Blowgun
BSPP
p. L6



0621

Standard Safety
Blowgun NPT
p. L6



Silencers

0673 0610 0670

Threaded Silencer
UNF, NPT or BSPP
p. L7



0671

Plug-In Silencer
p. L7



0673

Compact Threaded
Silencer Male
BSPP, M5
p. L7



0677

Miniature
Silencer BSPP
p. L7



0614 0672

Flow Control
Silencer Male
NPT, BSPP
p. L8



0611 0674

Threaded Silencer
NPT, BSPP, M5
p. L8



0676

Flow Control
Silencer BSPP
p. L8



0682

Stainless Steel
Threaded Silencer
Male BSPP
p. L8



0683

Stainless Steel
Threaded Silencer
Male NPT
p. L8



Sealing Accessories and Plugs

0138

Copper Washer
BSPP and Metric
p. L9



0139

Bi-Material
Captive Sealing
Washer BSPP
p. L9



0602

Captive Sealing
Washer BSPP
and M5
p. L9



0127

Tube Support
for Nylon and
Polyurethane
Tubing
p. L10



1827

Tube Support for
Fluoropolymer
Tubing
p. L10



0200

Hex Head Plug
BSPP and Metric
p. L11



0205

Internal Hex
Head Plug NPT
and BSPT
p. L11



0285

Internal Hex Head
NPT and BSPT
p. L11



0206

Internal Hex Head
NPT and BSPT
p. L11



WARNING These products can expose you to chemicals including NICKEL or LEAD, which are known to the state of California to cause cancer and LEAD.

Bins

16-CB

16 Compartment
p. L13



24-CB

24 Compartment
p. L13



ADJ-CB

Adjustable
Compartments
p. L13



4CB-SR

Slide Rack
p. L13



LSR-STAND

Stand
p. L14



9-DC

9 Drawer
p. L14



18-DC

18 Drawer
p. L14



24B-CABINET

24 Opening
p. L14



40B-STAND

Stand
p. L14



40B-CABINET

40 Opening
p. L15



WARNING These products can expose you to chemicals including NICKEL or LEAD, which are known to the state of California to cause cancer and LEAD.

[Click here for CADs, Product Specifications or to Configure Parts Online](#)

Blow Guns

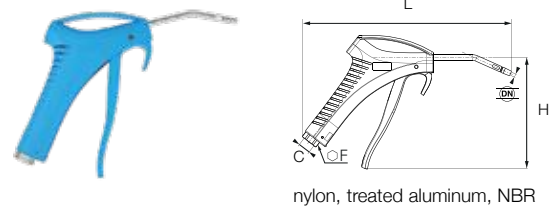
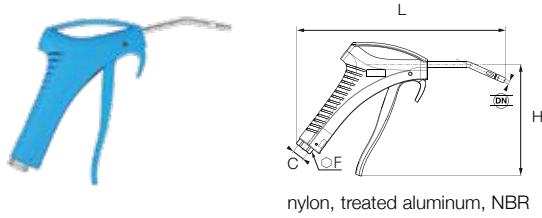

0659 Standard Blowgun Lower Connection with Short Angled Nozzle - NPT

PART NO.	C NPT	C1 METRIC	F MM	H IN	L IN	W KG
0659 00 14	1/4	M12 X 1.25	20	4.71	8.78	2.50

0659 Standard Blowgun Lower Connection with Short Angled Nozzle - BSPP

PART NO.	C BSPP	C1 METRIC	F MM	H MM	L MM	W KG
0654 00 13	G1/4	M12 X 1.25	20	120	223	.072

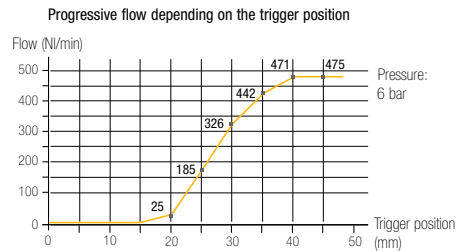
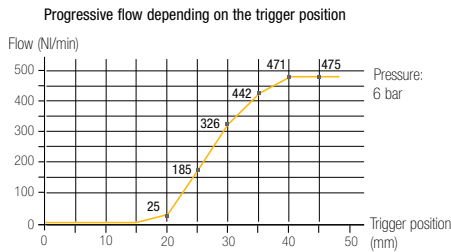

- 475 NI/min
- 82 dBA
- OSHA 1910.242 (b)
OSHA 1910.95 (b)
2003/10/EC directive:
Requirement to use ear protection
if exposure > 8 hours

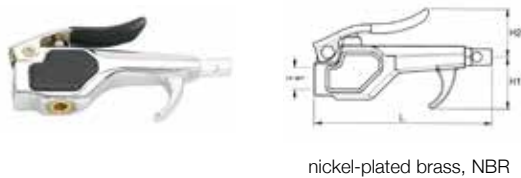

0621 Standard Safety Blowgun NPT

PART NO.	C NPT	H1 IN	H2 IN	L IN	W KG
0621 00 14	1/4	1.28	1.18	4.32	6.89

Silencers

Technical Specification of Silencers:

MATERIAL	WORKING PRESSURE	WORKING TEMPERATURE
SINTERED BRONZE	175 PSI (12.0 bar)	-4° to +300° F (-20° to +148.8° C)
POLYETHYLENE	145 PSI (9.9 bar)	-14° to +175° F (-25.5° to +79.4° C)
STAINLESS STEEL	175 PSI (12.0 bar)	-4° to +355° F (-20° to +179.4° C)

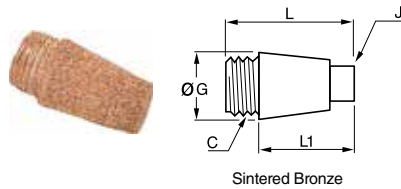

0673 0610 0670 Threaded Silencer UNF, NPT or BSPP

PART NO.	C UNF/NPT	J IN	G IN	L IN	L1 IN	W OZ
0673 00 20*	10-32	.27	.31	.34	.18	.07
0610 00 11	1/8	.31	.42	.89	.71	.21
0610 00 14	1/4	.39	.59	1.10	.87	.46
0610 00 18	3/8	.51	.75	1.42	1.14	.85
0610 00 22	1/2	.59	.91	1.73	1.42	1.48

PART NO.	C BSPP	J MM	G MM	L MM	L1 MM	W KG
0670 00 10	G1/8	7	12	20.5	15	.007
0670 00 13	G1/4	8	15	24.5	18.5	.013
0670 00 17	G3/8	10	19	37	29	.033
0670 00 21	G1/2	14	23	40	31	.049
0670 00 27	G3/4	16.5	29.5	51	40.5	.092
0670 00 34	G1	20	36	60	49.5	.140

* Brass Body

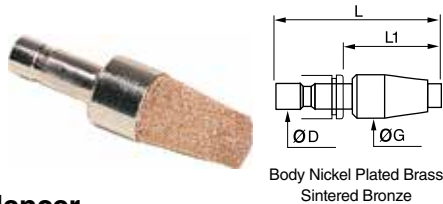

0671 Plug-In Silencer

PART NO.	C	G MM	L MM	L1 MM	W OZ
0671 04 00	4	13	41.5	24.5	.015
0671 06 00	6	15	48	29	.023
0671 08 00	8	15	49.5	29.5	.024
0671 10 00	10	19.5	68	43.5	.054
0671 12 00	12	20	68.5	43	.055

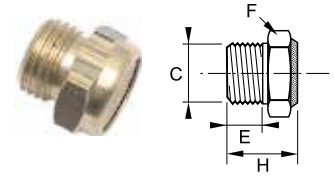

0673 Compact Threaded Silencer Male BSPP, M5

PART NO.	C BSPP/M5	E MM	F MM	H MM	W OZ
0673 00 10	G1/8	4	13	12	.006
0673 00 13	G1/4	6	16	16	.012
0673 00 17	G3/8	8	19	17	.022
0673 00 19	M5X0.8	8	8	8.5	.001
0673 00 20	UNF 10-32	4	6	11	.006
0673 00 21	G1/2	9	24	18	.037

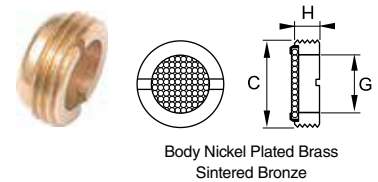

0677 Miniature Silencer BSPP

PART NO.	C BSPP	G MM	H MM	W OZ
0677 00 10	G1/8	5.5	4	.002
0677 00 13	G1/4	6	4.5	.003
0677 00 17	G3/8	9.5	5	.006
0677 00 21	G1/2	12.5	5.5	.012
0677 00 27	G3/4	19	6	.014
0677 00 34	G1	24	7	.025

[Click here for CADs, Product Specifications or to Configure Parts Online](#)

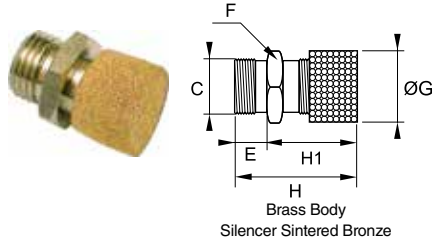

0614 0672 Flow Control Silencer Male NPT, BSPP

PART NO.	C NPT	E	F MM	G	H MIN	H MAX	H1	W OZ
0614 00 22	1/2	.47	27	1.06	1.54	1.65	1.30	1.55

PART NO.	C BSPP	E MM	F MM	G MM	H MIN	H MAX	H1 MM	W KG
0672 00 10	1/8	8	14	14	24	27	18	.012
0672 00 13	1/4	8	17	17	25	28	19	.023
0672 00 17	3/8	10	22	22	30	33	24	.033
0672 00 21	1/2	12	27	27	39	42	33	.044

Consult us for flow characteristics

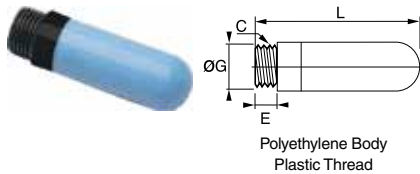

0611 0674 Threaded Silencer NPT, BSPP, M5

PART NO.	C NPT	E IN	G IN	L IN	W OZ
0611 00 11	1/8	.24	.49	1.34	.07
0611 00 14	1/4	.28	.61	1.67	.11
0611 00 22	1/2	.43	.93	3.07	.35

PART NO.	C BSPP	E MM	G MM	L MM	W OZ
0674 00 19	M5X0.8	4	6.5	23	.001
0674 00 10	G1/8	6	12.5	34	.002
0674 00 13	G1/4	7	15.5	42.5	.003
0674 00 17	G3/8	11.5	18.5	67.5	.006
0674 00 21	G1/2	11	23.5	78	.010
0674 00 27	G3/4	15.5	38.5	131	.040
0674 00 34	G1	19.5	49	160	.050

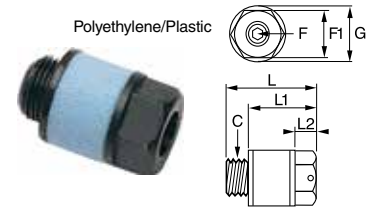

0676 Flow Control Silencer BSPP

PART NO.	C BSPP	F MM	F1 MM	G MM	L MM	L1 MM	L2 MM	W OZ
0676 00 10	G1/8	2.5	13	15	20.5	14.5	5	.002
0676 00 13	G1/4	4	15	18	29	22	7	.007

FLOW SCFM AT 87 PSI											NOISE LEVEL DBA*
NO. OF TURNS	0	1	2	3	4	5	6	7	8	9	
0676 00 10	0	1.06	3.2	7.4	11.8	13	13.8	13.8	13.9	13.9	82
0676 00 13	0	.78	.88	1.77	12	26.5	33	34.6	35.3	36	84

* dBA at 87 PSI and 12 SCFM

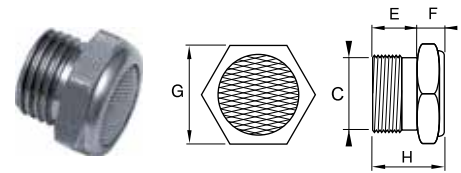

0682 Stainless Steel Threaded Silencer Male BSPP

PART NO.	C BSPP	E MM	F MM	G MM	H MM	W KG
0682 00 10	G1/8	8	7	14	15	.009
0682 00 13	G1/4	8	7	17	15	.013
0682 00 17	G3/8	10	8	22	18	.020
0682 00 21	G1/2	12	10	27	22	.038
0682 00 27	G3/4	15	12	32	27	.066
0682 00 34	G1	18	14	38	32	.118

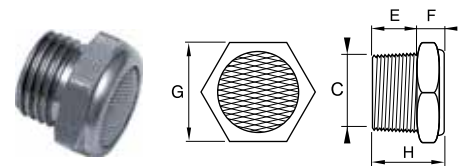

0683 Stainless Steel Threaded Silencer Male NPT

PART NO.	C NPT	E IN	F IN	G MM	H IN	W KG
0683 00 11	1/8	.28	.28	14	.55	.35
0683 00 14	1/4	.43	.28	17	.71	.53
0683 00 18	3/8	.43	.31	22	.75	.81
0683 00 22	1/2	.59	.39	27	.98	1.55

Sealing Accessories and Plugs

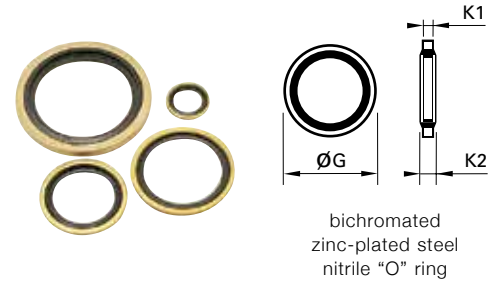
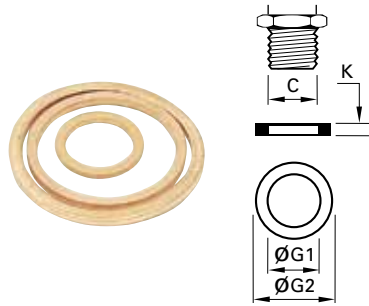

0138 Copper Washer BSPP and Metric

PART NO.	C MM	G1 MM	G2 MM	K MM	W KG
0138 06 00	M6	6.3	9	1	.033
0138 08 00	M8	8.3	11	1	.001
0138 12 00	M12	12.3	15.5	1.5	.072
0138 14 00	M14	14.3	18	1.5	.001
0138 16 00	M16	16.3	20	1.5	.001
0138 18 00	M18	18.3	22	1.5	.001
0138 20 00	M20	20.3	24	1.5	.001
0138 22 00	M22	22.3	27	1.5	.002
0138 24 00	M24	24.3	29	2	.003
0138 26 00	M26	26.3	31	2	.003
0138 30 00	M30	30.3	36	2	.004
0138 36 00	M36	36.3	42	2	.005
0138 39 00	M39	39.3	44	2	.007
0138 52 00	M52	52.3	60	2	.009
0138 10 00	G1/8	10.3	13.5	1	.001
0138 13 00	G1/4	13.5	18	1.3	.001
0138 17 00	G3/8	17.3	21	1.5	.001
0138 21 00	G1/2	21.3	26	1.5	.002
0138 27 00	G3/4	27.3	32	2	.003
0138 33 00	G1	33.5	39	2	.005
0138 42 00	G1 1/4	42.5	49	2	.007
0138 60 00	G2	60	68	2.5	.014

0139 Bi-Material Captive Sealing Washer BSPP

PART NO.	C BSPP	G MM	K1 MM	K2 MM	W KG
0139 10 00	G1/8	14	1	1.8	.001
0139 13 00	G1/4	17	1	1.8	.001
0139 17 00	G3/8	22	1.3	2.1	.001
0139 21 00	G1/2	26	1.6	2.4	.002
0139 27 00	G3/4	32	1.6	2.4	.002
0139 34 00	G1	43	3.5	4.5	.002

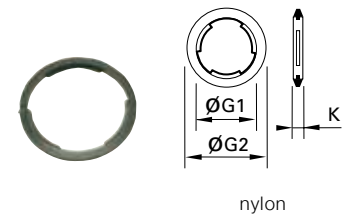

0602 Captive Sealing Washer BSPP and M5

PART NO.	C BSPP/M5	G1 MM	G2 MM	K MM	W KG
0602 29 93 15	M5X0.8	5.2	7.8	1.5	.001
0602 23 10 20	G1/8	10.3	14	2	.001
0602 23 11 20	G1/4	13.7	17.5	2	.001
0602 23 12 20	G3/8	17.2	21	2	.001
0602 23 13 20	G1/2	21.5	25.5	2.5	.001
0602 27 32 20	G3/4	27	32	2.5	.001
0602 30 60 20	G1	33.8	39	3	.001

Click here for CADs, Product Specifications or to Configure Parts Online

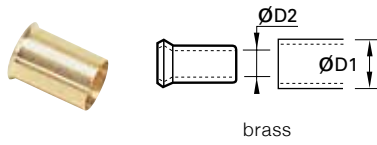

brass

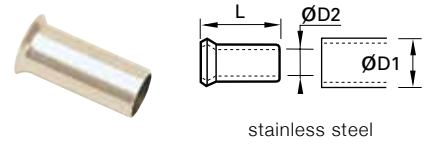

stainless steel

0127 Tube Support for Nylon and Polyurethane Tubing

PART NO.	ØD1 MM	ØD2 MM	W KG
0127 04 00	4	2	.001
0127 04 27	4	2.7	.001
0127 05 03	5	3	.001
0127 05 00	5	3.3	.001
0127 06 00	6	4	.001
0127 08 55	8	5.5	.001
0127 08 00	8	6	.001
0127 10 07	10	7	.002
0127 10 75	10	7.5	.002
0127 10 00	10	8	.002
0127 12 08	12	8	.002
0127 12 09	12	9	.002
0127 12 00	12	10	.002
0127 14 11	14	11	.003
0127 14 00	14	12	.003
0127 15 12	15	12	.003
0127 16 13	16	13	.003
0127 18 14	18	14	.004
0127 20 15	20	15	.004
0127 22 16	22	16	.005
0127 25 19	25	19	.005

1827 Tube Support for Fluoropolymer Tubing

PART NO.	ØD1 MM	ØD2 MM	L MM	W KG
PART	ØD1	ØD2	L	
NUMBER	MM	MM	MM	
1827 06 00	4	6	11.5	.001
1827 08 00	6	8	14	.001
1827 10 00	8	10	18	.002
1827 12 00	10	12	18	.002
1827 16 00	14	16	18	.003

This ferrule is necessary when using fluoropolymer at all temperatures compatible with the fitting/tube assembly.

⚠ WARNING These products can expose you to chemicals including NICKEL or LEAD, which are known to the state of California to cause cancer.

[Click here for CADs, Product Specifications or to Configure Parts Online](#)

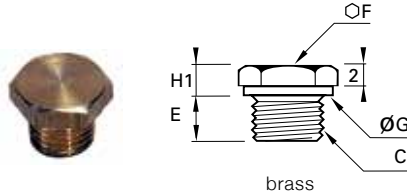

brass

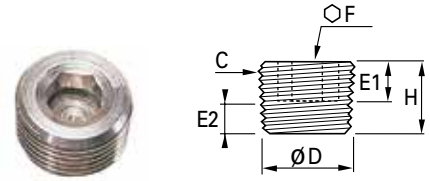

stainless steel AISI 316L

0200 Hex Head Plug BSPP and Metric

PART NO.	C BSPP	E MM	F MM	G MM	H1 MM	H2 MM	W KG
0200 10 00	G1/8	7	14	13.7	5.5	4	.012
0200 13 00	G1/4	8.5	17	16.7	5.5	4	.019

PART NO.	C METRIC	E MM	F MM	G MM	H1 MM	H2 MM	W KG
0200 52 00	M6X1	6	10	10	4	3.5	.004
0200 57 00	M8X1.25	7	13	13	4	3.5	.007
200 60 00	M10X10	8	14	14	5	4.5	.012
200 65 00	M12X10	9	17	17	5	4.5	.018
0200 66 00	M12X1.25	9	17	17	5	4.5	.018

Parallel metric threads ISO – standards NFE 03-054 and BNA 541.
Parallel metric threads – standards NFE 03-005 and BNA 541.

0285 Internal Hex Head NPT and BSPT

PART NO.	C NPT	ØD IN	E1 IN	E2 MIN IN	E2 MAX IN	F MM	H IN	W OZ
0285 11 00	1/8	.40	.24	.13	.20	5	.31	.14
0285 14 00	1/4	.54	.31	.17	.28	6	.39	.25
0285 18 00	3/8	.67	.31	.19	.30	8	.43	.49
0285 22 00	1/2	.84	.31	.25	.39	10	.51	.88

PART NO.	C BSPT	ØD MM	E1 MM	E2 MIN MM	E2 MAX MM	F MM	H MM	W KG
0285 10 00	R1/8	9.728	6	3.1	4.9	5	8	.003
0285 13 00	R1/4	13.157	8	4.7	7.3	6	10	.007
0285 17 00	R3/8	16.662	8	5.1	7.7	8	11	.013
0285 21 00	R1/2	20.955	8	6.4	10	10	13	.024
0285 27 00	R3/4	26.441	11	7.7	11.3	14	17	.048
0285 34 00	R1	33.249	13	8.1	12.7	17	19	.086
0285 34 00	R1-1/4	41.910	14	10.4	15	22	22	.162
0285 34 00	R1-1/2	47.803	14	10.4	15	24	22	.222

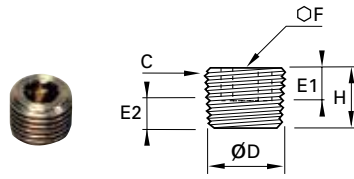

brass

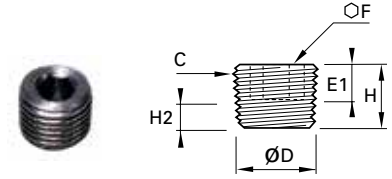

untreated steel

0205 Internal Hex Head Plug NPT and BSPT

PART NO.	C NPT	ØD IN	E1 IN	E2 MIN IN	E2 MAX IN	F IN	H IN	W OZ
0205 11 00	1/8	.40	.24	.12	.20	.79	.31	.141
0205 14 00	1/4	.54	.31	.17	.28	.94	.39	.282
0205 18 00	3/8	.67	.31	.18	.29	1.22	.43	.494
0205 22 00	1/2	.93	.31	.25	.39	1.53	.51	.917
0205 28 00	3/4	1.04	.43	.27	.41	2.16	.67	1.834
0205 35 00	1	1.31	.51	.31	.49	2.95	.75	3.245

PART NO.	C BSPT	ØD MM	E1 MM	E2 MIN MM	E2 MAX MM	F MM	H MM	W KG
0205 10 00	R1/8	9.728	6	3.1	4.9	5	8	.004
0205 13 00	R1/4	13.157	8	4.7	7.3	6	10	.008
0205 17 00	R3/8	16.662	8	5.1	7.7	8	11	.014
0205 21 00	R1/2	20.955	8	6.4	10	10	13	.027
0205 27 00	R3/4	26.441	11	7.7	11.3	14	17	.053
0205 34 00	R1	33.249	13	8.1	12.7	17	19	.092
0205 42 00	R1-1/4	41.910	14	10.4	15	22	22	.183
0205 49 00	R1-1/2	47.803	14	10.4	15	24	22	.250
0205 48 00	R2	59.614	16	13.6	18.2	30	25	.440

For BSP taper plus 1/2" - 1 1/2" inclusive - thread standard NFE 03-004 - DIN906

0206 Internal Hex Head NPT and BSPT

PART NO.	C NPT	ØD IN	E1 IN	E2 MIN IN	E2 MAX IN	F MM	H IN	W OZ
0206 08 00	1/16	.31	.24	.15	.25	.16	.26	.070
0206 11 00	1/8	.40	.24	.12	.20	.20	.31	.106
0206 14 00	1/4	.54	.31	.17	.28	.24	.39	.247
0206 18 00	3/8	.67	.31	.18	.29	.31	.43	.423
0206 22 00	1/2	.83	.31	.25	.39	.39	.51	.847
0206 28 00	3/4	1.04	.43	.27	.41	.55	.67	1.658
0206 35 00	1	1.31	.51	.31	.49	.67	.75	2.928

PART NO.	C BSPT	ØD MM	E1 MM	E2 MIN MM	E2 MAX MM	F MM	H MM	W KG
0285 10 00	R1/8	9.728	6	3.1	4.9	5	8	.003
0285 13 00	R1/4	13.157	8	4.7	7.3	6	10	.007
0285 17 00	R3/8	16.662	8	5.1	7.7	8	11	.013
0285 21 00	R1/2	20.955	8	6.4	10	10	13	.024
0285 27 00	R3/4	26.441	11	7.7	11.3	14	17	.048
0285 34 00	R1	33.249	13	8.1	12.7	17	19	.086
0285 34 00	R1-1/4	41.910	14	10.4	15	22	22	.162
0285 34 00	R1-1/2	47.803	14	10.4	15	24	22	.222

For BSP taper plugs 1/2" - 1 1/2" inclusive - conform to standard BNA 247 - thread - DIN 906 standard NFE 03-004

WARNING These products can expose you to chemicals including NICKEL or LEAD, which are known to the state of California to cause cancer.

Cabinet

Store hundreds of Parker Legris products in one location.

This valuable product management tool is great for facilities that recognize the need for inventory management programs. When implemented with your specific needs, this cabinet provides ease of access, clear product identification, reduced inventory costs as well as increased productivity.



Part Number
3150 00 05 53

- Overall dimensions
16 7/8" wide x 28 1/2" deep x 38 1/8" tall
- Lockable drawers
- Heavy-duty, all-steel construction
- Customizable drawer compartments
Keeps products separate and allows rapid part selection
- "At a Glance" chart for quick reference
- Casters for easy transportation with locks to hold in place

Parker Legris Fit Kit

Convenient storage bin filled with our most common fittings.

- Fractional Inch version: Part number **3150 00 06 24**
- Metric version: Part number **3150 00 06 31**
- Products available in most common diameters: 5/32, 1/8 and 1/4
- 1/8, 1/4 and 3/8 NPT Threads
- Fit Kit contains a selection of 20 configuration of our most common used products



Bins

16 Compartment Large Scoop Box

- Prime cold rolled steel outer shell
- High impact styrene insert with 16 compartments
- Scooped bottom compartments for easy part removal
- Full piano hinge on cover provides rigidity
- Positive pull-down catch keeps cover tightly closed to prevent part migration
- Handle allows for easy transport
- Durable gray powder coat finish

PART NO.	DIMENSIONS (IN.)		
	WIDTH	DEPTH	HEIGHT
16-CB	18	12	3



24 Compartment Large Scoop Box

- Prime cold rolled steel outer shell
- High impact styrene insert with 24 compartments
- Scooped bottom compartments for easy part removal
- Full piano hinge on cover provides rigidity
- Positive pull-down catch keeps cover tightly closed to prevent part migration
- Handle allows for easy transport
- Durable gray powder coat finish

PART NO.	DIMENSIONS (IN.)		
	WIDTH	DEPTH	HEIGHT
24-CB	18	12	3



ADJ-CB

- Prime cold rolled steel outer shell
- High impact styrene insert with 4 fixed vertical compartments and 9 moveable dividers adjustable on 1" centers
- Full piano hinge on cover provides rigidity
- Positive pull-down catch keeps cover tightly closed to prevent part migration
- Durable gray powder coat finish

PART NO.	DIMENSIONS (IN.)			COMPARTMENTS
	WIDTH	DEPTH	HEIGHT	
ADJ-CB	18	12	3	ADJUSTABLE



Easy Glide Slide Rack (Holds 4 16-CB or 24-CB per rack)

- Sturdy construction using prime cold-rolled steel
- Each cradle holds up to 40 lbs
- Easy glide slides allow boxes to move in and out smoothly
- Center braces on cradles provide extra rigidity
- Reinforced rack keeps boxes level
- Boxes can be easily removed for transport to work areas
- Base and locking hinge are available as accessories
- Durable gray powder coat finish

PART NO.	DIMENSIONS (IN.)		
	WIDTH	DEPTH	HEIGHT
4CB-SR	20	15.75	15



LSR-Stand

- Sturdy all steel construction
- Legs attach easily using fasteners provided
- Raises units 15 inches off the floor
- Durable gray powder finish

PART NO.	DIMENSIONS (IN.)		
	WIDTH	DEPTH	HEIGHT
LSR-STAND	20 5/8	16 1/4	15 5/8



9 Drawer Cabinet

- Prime cold rolled steel construction
- High density drawer cabinet, easy to store large quantities of small parts
- Drawers feature interlocking design for superior strength
- Drawers have full width handles and easy glide runners
- Each drawer includes 2 easy label dividers, which are adjustable on 1" centers
- Cabinets can be stacked using mounting holes
- Durable gray powder coat finish
- Ships fully assembled

PART NO.	DIMENSIONS (IN.)			DRAWER DIMENSIONS (IN.)		
	WIDTH	DEPTH	HEIGHT	WIDTH	DEPTH	HEIGHT
9-DC	17.25	11.625	10.875	5.375	11.25	2.75



18 Drawer Cabinet

- Prime cold rolled steel construction
- High density drawer cabinet, easy to store large quantities of small parts
- Drawers feature interlocking design for superior strength
- Drawers have full width handles and easy glide runners
- Each drawer includes 2 easy label dividers, which are adjustable on 1" centers
- Cabinets can be stacked using mounting holes
- Durable gray powder coat finish
- Ships fully assembled

PART NO.	DIMENSIONS (IN.)			DRAWER DIMENSIONS (IN.)		
	WIDTH	DEPTH	HEIGHT	WIDTH	DEPTH	HEIGHT
18-DC	17.25	11.625	21.25	5.375	11.25	2.75



24 Opening Bin

- All welded, prime cold rolled steel
- Fully hemmed 1 1/8" bin fronts to hold labels and retain parts
- Roll-formed sides for increased strength and stability
- Ribbed and hemmed dividers provide added strength
- Modular with most 12" deep bins and drawer cabinets; mounting holes are located at both the top and bottom
- Durable gray powder coat finish
- Ships fully assembled

PART NO.	DIMENSIONS (IN.)			BIN DIMENSIONS (IN.)		
	WIDTH	DEPTH	HEIGHT	WIDTH	DEPTH	HEIGHT
24B-CABINET	33.75	12	23.875	5.375	11.875	5.5



Parker Brass Products Base Stand for 40B Cabinets

- Stands are 12" high
- Designed for use with 40B Cabinets
- Each stand includes a 15 piece bolt and nut set package for assembly

PART NO.	DIMENSIONS (IN.)		
	WIDTH	DEPTH	HEIGHT
40B-STAND	33.75	12	23.875



[Click here for CADs, Product Specifications or to Configure Parts Online](#)

40 Opening Bin

- All welded, prime cold rolled steel
- Fully hemmed 1 1/8" bin fronts to hold labels and retain parts
- Roll-formed sides for increased strength and stability
- Ribbed and hemmed dividers provide added strength
- Modular with most 12" deep bins and drawer cabinets; mounting holes are located at both the top and bottom
- Durable gray powder coat finish
- Ships fully assembled



PART NO.	DIMENSIONS (IN.)			BIN DIMENSIONS (IN.)		
	WIDTH	DEPTH	HEIGHT	WIDTH	DEPTH	HEIGHT
40B-CABINET	33.75	12	23.875	3.8125	11.875	3.8125



Tubing

Nylon Tubing

Polyurethane Tubing

Polyethylene Tubing

Nylon Self-Storing Air Hose

Supercoil® PU Self-Storing Air Hose

Polyurethane 95A Mini Coil Tubing





GOODYEAR
RUBBER PRODUCTS, INC.

☎ 727-342-5088

You can also email us at
GRP@goodyearrubberproducts.com

Nylon Tubing

p. K4



Fluids: compressed air, industrial fluids

Materials:

- Nylon
- 8 colors available

Pressure: 160–500 psi (11–35 bar)

Temperature: -40° to 200°F (-40° to 93°C)

Pressure ratings are also effected by diameter of tubing and wall thickness. Actual performance may vary with different media and working conditions.

O.D. fractional: 1/8 to 1/2

O.D. metric: 4mm to 16mm

Polyurethane Tubing

p. K7



Fluids: compressed air, industrial fluids

Materials:

- Polyurethane 95A durometer
- 7 colors available

Pressure: 125–200 psi (8.5–14 bar)

Temperature: -40° to 165°F (-40° to 74°C)

Pressure ratings are also effected by diameter of tubing and wall thickness. Actual performance may vary with different media and working conditions.

O.D. fractional: 1/8 to 1/2

O.D. metric: 4mm to 16mm

Polyethylene Tubing

p. K9



Fluids: compressed air, industrial fluids and food handling application (except holding food during cooking)

Materials:

- Low density polyethylene
- FDA CF21, part 177 (all colors)
- 6 colors available

Pressure: 83–200 psi (5.7–13 bar)

Temperature: -100° to 150°F (-73°C to 66°C)

Pressure ratings are also effected by diameter of tubing and wall thickness. Actual performance may vary with different media and working conditions.

O.D. fractional: 5/32 to 1/2

O.D. metric: 4mm to 12mm

Nylon Self-Storing Air Hose

p. K11



Fluids: compressed air, industrial fluids

Materials:

- Nylon
- 2 colors available
- 1/4 NPT fittings with pre-applied thread sealant

Pressure: up to 250 psi (17 bar)

Temperature: -40° to 200° F (-40° to 93° C)

Maximum pressure and temperature range are dependent on tube diameter used.

O.D. fractional: 1/4 to 3/16

Supercoil® PU Self-Storing Air Hose

p. K13



Fluids: compressed air

Materials:

- Polyurethane 95A durometer
- 2 colors available
- 1/4 NPT fittings with pre-applied thread sealant

Pressure: up to 150 psi (10 bar)

Temperature: -40° to 165° F (-40° to 74° C)

Maximum pressure and temperature range are dependent on tube diameter used.

O.D. fractional: 1/4 to 3/16

Polyurethane 95A Mini Coil Tubing

p. K14



Fluids: compressed air, industrial fluids

Materials:

- Polyurethane 95 shore A durometer
- 2 colors available

Pressure: up to 233 psi (16 bar)

Temperature: -40° to 165° F (-40° to 74° C)

Maximum pressure and temperature range are dependent on tube diameter used.

O.D. fractional: 3/32, 1/8

How to Read the Graphs

In the graphs in this chapter, each curve represents the acceptable maximum pressure at a given temperature, by diameter.

Technical characteristics of Parker Legris tubing depend on the type of connection used.

The vacuum capability of all tubing is 755 mm Hg (99% vacuum).

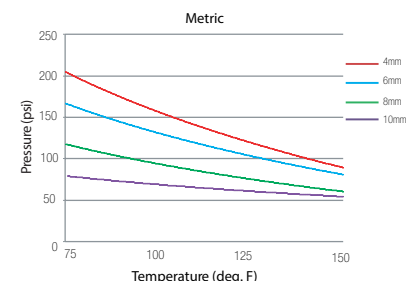

Nylon Tubing

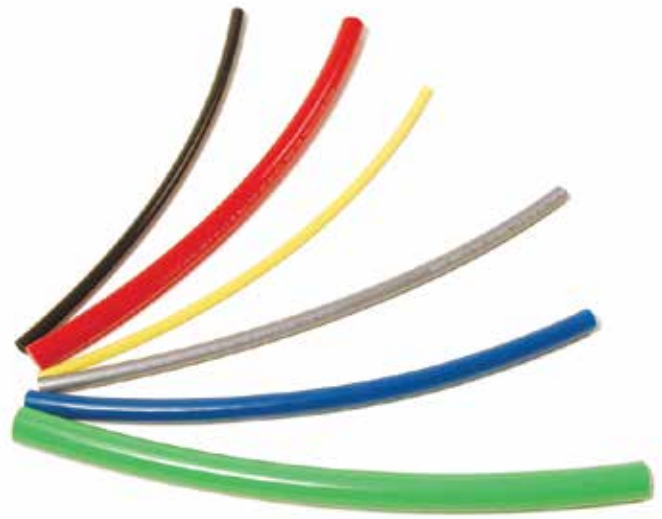

Nylon tubing is a popular choice for low pressure pneumatic applications because of its combination of flexibility and toughness. Nycoil uses a heat and light stabilized, very flexible compound that yields a quality tube. Nylon is the most recommended tubing material for all types of pneumatic circuits.

A circuit designer could never get into trouble using Nylon tubing for pneumatic circuits. Due to its physical properties, Nylon is the number one choice for reliable connections with all types of fittings. Nylon retains its performance integrity in elevated temperatures and generally, because of its higher pressure and temperature characteristics, Nylon will have a greater flow passage than composite tubing made from other material with the same outside diameter. These factors should never be overlooked when designing pneumatic circuits.



Product Advantages:

- Flexible
- Good Chemical Resistance
- Low Moisture Absorption
- Superior Dimensional Stability

Applications:

- Low Pressure Pneumatic
- Pneumatic Circuits
- Injection Lube Systems
- Hydro-Pneumatic Circuit

Nylon Products

- Pneumatic Tubing
- Mini-Coils
- Capillary Tubing

Specifications:

Compatible Fluids Compressed air, industrial fluids

up to 667 psi (46 bar)
 Pressure ratings are also effected by diameter of tubing and wall thickness.
 Actual performance may vary with different media and working conditions.

Working Pressure

Working Temperature -40° to +200° F (-40° to +93° C)

Packaging

TubePack®: 50ft, 100ft, 250ft, 25m and 100m
 Reels: 500ft

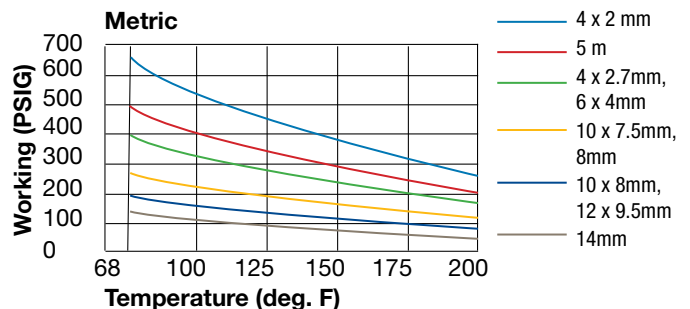
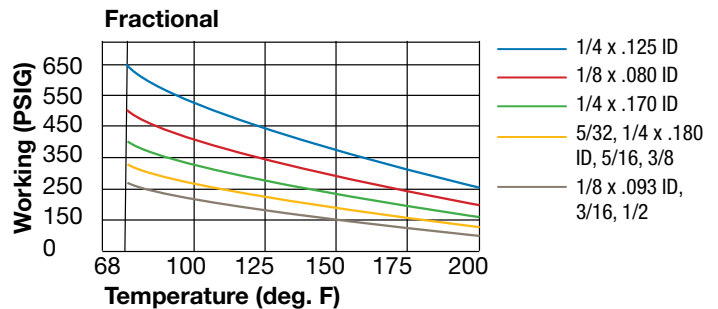







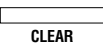

[Click here for CADs, Product Specifications or to Configure Parts Online](#)











Nycoil Nylon Fractional Inch

100ft Tubepack®

ØD IN	I.D. IN										WEIGHT (LBS/1000FT)
1/8	.093	1/2"	61220	61221	61224	61222	61223				2.50
5/32	.106	5/8"							61237	61236	4.80
3/16	.137	3/4"	61330	61331							5.80
1/4	.170	7/8"	61470	61471	61474	61472	61473	61475	61477	61476	12.20
5/16	.232	1"	61550	61551	61554	61552	61553	61555	61557		15.70
3/8	.275	1 1/4"	61660	61661	61664	61662	61663	61665		61666	23.30
1/2	.375	2 1/4"	61880	61881	61884	61882	61883	61885	61887		39.00







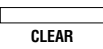

Nycoil Nylon Metric

100ft Tubepack®

ØD MM	I.D. MM										WEIGHT (LBS/1000FT)
4	2.7	24	71040	71041			71043		71047		3.80
4	2.0	24	71020	71021	71024	71022	71023	71025	71027		6.80
5	3.0	30	71050								9.00
6	4.0	36	71060	71061	71064	71062	71063	71065	71067		11.20
8	6.0	48	71080	71081	71084	71082	71083	71085	71087		15.00
10	7.5	70	71100								20.20
10	8.0	60	71110	71111	71114	71112	71113	71115	71117		24.60
12	9.5	70	71120	71121			71123	71125			30.10
14	12.0	100	71160	71161			71163				29.10

Nycoil Nylon Fractional Inch

500ft Tubepack®

ØD IN	I.D. IN										WEIGHT (LBS/1000FT)
1/8	.093	1/2"	65220	65221	-	65222	-	-	-	-	2.50
5/32	.106	5/8"	65230	65231	65234	65232	65233	65235	65237	-	4.80
3/16	.137	3/4"	65330	65331	-	-	-	-	-	-	5.80
1/4	.170	7/8"	65470	65471	65474	65472	65473	65475	65477	-	12.20
5/16	.232	1"	65550	65551	-	65552	65553	-	-	-	15.70
3/8	.275	1 1/4"	65660	65661	65664	65662	65663	65665	-	-	23.30
1/2	.375	2 1/4"	68880*	68881*	68884*	68882*	68883*	-	-	-	39.00







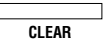

*250 ft. Reel

WARNING: These products can expose you to chemicals including NICKEL, CARBON BLACK, TITANIUM DIOXIDE, or LEAD, which are known to the state of California to cause cancer or reproductive harm. For more information, go to www.P65Warnings.ca.gov.

[Click here for CADs, Product Specifications or to Configure Parts Online](#)

Nycoil Nylon Metric







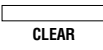

500ft Tubepack®

ØD MM	I.D. MM										WEIGHT (LBS/1000FT)
			CLEAR	BLACK	GREEN	RED	BLUE	YELLOW	GRAY	ORANGE	
4	2.7	24	-	-	-	-	-	-	-	-	3.80
4	2.0	24	74020	74021	-	-	74023	-	-	-	6.80
5	3.0	30	-	-	-	-	-	-	-	-	9.00
6	4.0	36	74060	74061	74064	74062	74063	-	-	-	11.20
8	6.0	48	74080	74081	74084	74082	74083	-	-	-	15.00
10	7.5	70	-	-	-	-	-	-	-	-	20.20
10	8.0	60	74110	74111	74114	74112	74113	-	-	-	24.60
12	9.5	70	74120	74121	-	74122	74123	-	-	-	30.10
14	12.0	100	-	-	-	-	-	-	-	-	29.10









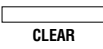

Nycoil Nylon Fractional Inch

1000ft Tubepack®

ØD IN	I.D. IN										WEIGHT (LBS/1000FT)
			CLEAR	BLACK	GREEN	RED	BLUE	YELLOW	GRAY	ORANGE	
1/8	.093	1/2"	-	-	-	-	-	-	-	-	2.50
3/16	.137	3/4"	60330	60331	-	-	-	-	-	-	5.80
1/4	.170	7/8"	60470	60471	-	-	-	-	-	-	12.20
5/16	.232	1"	60550	60551	-	-	60553	-	-	-	15.70
3/8	.275	1 1/4"	60660	60661	-	-	-	-	-	-	23.30
1/2	.375	2 1/4"	60880	60881	-	-	-	-	-	-	39.00

Nycoil Nylon Metric

1000ft Tubepack®

ØD MM	I.D. MM										WEIGHT (LBS/1000FT)
			CLEAR	BLACK	GREEN	RED	BLUE	YELLOW	GRAY	ORANGE	
4	2.7	24	77040	77041	-	-	-	-	-	-	3.80
4	2.0	24	-	-	-	-	-	-	-	-	6.80
5	3.0	30	-	-	-	-	-	-	-	-	9.00
6	4.0	36	77060	77061	-	-	-	-	-	-	11.20
8	6.0	48	77080	77081	-	-	-	-	-	-	15.80
10	7.5	70	77110	77111	-	-	-	-	-	-	20.20
10	8.0	60	-	-	-	-	-	-	-	-	24.60
12	9.5	70	77120	77121	-	-	-	-	-	-	30.10
14	12.0	100	-	-	-	-	-	-	-	-	29.10

WARNING These products can expose you to chemicals including NICKEL, CARBON BLACK, TITANIUM DIOXIDE, or LEAD, which are known to the state of



Polyurethane Tubing

Polyurethane tubing is usually the best choice for applications requiring extensive flexing, a small bend radius or where kinking can be a problem. Nycoil uses a raw material that will not break down or be affected in any way by moisture. Being a naturally rubbery compound, it requires no plasticizers that can leach out over time. This material also offers superior resistance to grease, oils, fuels and abrasion, making it suitable for a wide variety of applications.

Since Nycoil's Push-To-Connect Fittings have the highest gripping "force" as compared to other brands, it is assured that our tubing will always work with our fittings. However, when using Push-To-Connect Fittings from other manufacturers with any brand of Polyurethane tubing, testing for retention reliability is strongly recommended. Further, we recommend using only Polyurethane tubing made from 95A Durometer hardness compound with Push-To-Connect Fittings. In addition, compression type fittings should never be used with Polyurethane tubing of any hardness.

Property Overview:

- Extreme Flexibility
- Reduced Bend Radius
- Moisture Resistant
- Abrasion Resistant
- Compatible Fittings:
 - Push-To-Connect
 - Hose Barb

Typical Applications:

- Water & Pneumatic Lines
- Spot Welders
- Machines
- Tools
- Pneumatic Plumbing
- Pick & Place Automation
- Product Specifications:



Compatible Fluids

Compressed air, industrial fluids

Working Pressure

125 PSI – 200 PSI
(8.5 BAR – 14 BAR)
Pressure ratings are also effected by diameter of tubing and wall thickness. Actual performance may vary with different media and working conditions.

Temperature Range

-40° to 165° F (-40° to 74° C)

Packaging

TubePack®: 50ft, 100ft, 250ft, 25m and 100m

Reels: 500ft

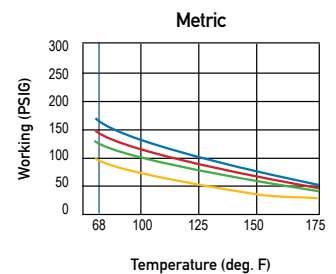
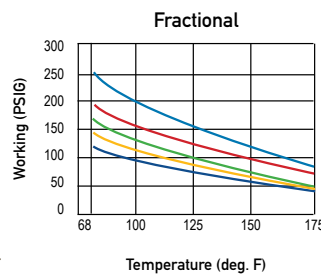

— 1/8, 1/4 x .125 ID — 1/4 x .170 ID, 3/8
— 3/16 — 1/2
— 5/32







— 4mm, 5mm — 6mm, 10 x 7mm
— 10 x 6.5mm — 8mm, 12 mm

[Click here for CADs, Product Specifications or to Configure Parts Online](#)

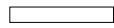







Polyurethane 95 Shore A Durometer Fractional Inch

100ft Tubepack®

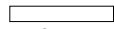
ØD IN	I.D. IN		 CLEAR	 BLACK	 GREEN	 RED	 BLUE	 YELLOW	 GRAY	WEIGHT (LBS/1000FT)
1/8	0.062	1/4	63220	63221	63224	63222	63223	63225	-	0.48
5/32	0.093	3/8	63250	63251	63254	63252	63253	63255	63257	0.62
1/4	0.16	1/2	63440	63441	63444	63442	63443	63445	63447	1.46
5/16	0.216	3/4	63550	63551	63554	63552	63553	63555	-	2.00
3/8	0.25	1	63660	63661	63664	63662	63663	63665	-	3.30
1/2	0.32	2	63870	63871	63874	63872	63873	63875	-	5.85

Polyurethane 95 Shore A Durometer Metric







100ft Tubepack®

ØD MM	I.D. MM		 CLEAR	 BLACK	 GREEN	 RED	 BLUE	 YELLOW	 GRAY	WEIGHT (LBS/1000FT)
4	2.5	12	73030	73031	73034	73032	73033	73035	73037	2.40
6	4	15	73060	73061	73064	73062	73063	73065	73067	3.10
8	5.5	20	73080	73081	73084	73082	73083	73085	73087	7.30
10	7	25	73100	73101	73104	73102	73103	73105	73107	10.00
12	8	35	73130	73131	73134	73132	73133	73135	73137	16.50

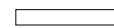

Polyurethane 95 Shore A Durometer Fractional Inch

500ft Reel

ØD IN	I.D. IN		 CLEAR	 BLACK	 GREEN	 RED	 BLUE	 YELLOW	WEIGHT (LBS/1000FT)
1/8	0.062	0.25	67220	67221	-	67222	-	-	2.40
5/32	0.093	0.375	67250	67251	-	-	-	67255	3.10
1/4	0.16	0.5	67440	67441	67444	67442	67443	67445	7.30
5/16	0.216	0.75	-	-	-	-	67553	-	10.00
3/8	0.25	1	67660	67661	-	67662	67663	-	16.50

Consult factory for diameters and colors not shown in catalog. (480) 830-0216

WARNING: These products can expose you to chemicals including NICKEL, CARBON BLACK, TITANIUM DIOXIDE, or LEAD, which are known to the state of California to cause cancer or reproductive harm. For more information go to www.P65Warnings.ca.gov



Polyethylene Tubing

Polyethylene is the most commonly used tubing due to its flexibility, wide range of chemical resistance and lower cost. LLDPE has a much higher resistance to stress cracking as compared to other Polyethylene compounds. It is also chemically inert, meaning it forms a good barrier against moisture, vapors and gases – minimizing the possibility of leaks or contamination. Where prolonged exposure to sunlight or ultraviolet (UV) light is a concern, black tubing is recommended for extended life.

Property Overview:

- Flexible
- Chemically Inert
- UV Resistant (Black tube)

Compatible Fittings:

- Push-To-Connect
- Compression
- Hose Barb

Typical Applications:

- Potable Water Feed/Drains
- Pneumatic or Signal Lines
- Liquid/Air Transfer

Product Specifications:

Compatible Fluids Industrial Fluids

Working Pressure 83 PSI – 200 PSI
(5.7 BAR – 13 BAR)

Pressure ratings are also effected by diameter of tubing and wall thickness. Actual performance may vary with different media and working conditions.

Temperature Range -100°F to +150°F (-73°C to +66°C)

Packaging

TubePack®: 100ft, 250ft, 25m and 100m
Reels: 500ft

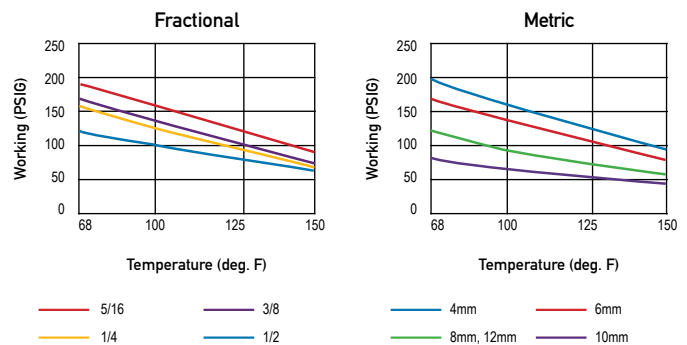



[Click here for CADs, Product Specifications or to Configure Parts Online](#)





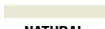



Low Density Polyethylene Fractional Inch

100ft Tubepack®

ØD IN	I.D. IN	 R	 NATURAL	 BLACK	 BLUE	WEIGHT (LBS/1000FT)
5/32	0.106	1	72030	–	–	3.70
1/4	0.17	1	62440	62441	62443	10.50
3/8	0.25	1-1/4	62660	62661	–	24.46
1/2	0.375	2-1/2	–	–	–	33.56



Low Density Polyethylene Fractional Inch

500ft Tubepack®

ØD IN	I.D. IN	 R	 NATURAL	 BLACK	 GREEN	 RED	 BLUE	 YELLOW	WEIGHT (LBS/1000FT)
5/32	0.106	1	75030	–	–	–	–	–	10.25
1/4	0.17	1	64440	64441	64444	64442	64443	64445	39.37
5/16	0.187	1-1/8	64550	–	–	–	–	–	48.77
3/8	0.25	1-1/4	64660	64661	64664	64662	64663	–	61.15
1/2	0.375	2-1/2	69880	69881	69884	–	–	–	83.9

Low Density Polyethylene Metric

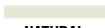
100ft Tubepack®

ØD MM	I.D. MM	 R	 NATURAL	 BLACK	 BLUE	WEIGHT (LBS/1000FT)
6	4	25	72060	72061	72063	4.50
8	6	38	72080	72081	72083	6.40
10	7	38	72110-XX	–	72113-XX	11.80
12	9	63	72130	–	72133	14.50

Consult factory for diameters and colors not shown in catalog. (480) 830-0216

⚠ WARNING: These products can expose you to chemicals including NICKEL, CARBON BLACK, TITANIUM DIOXIDE, or LEAD, which are known to the state of

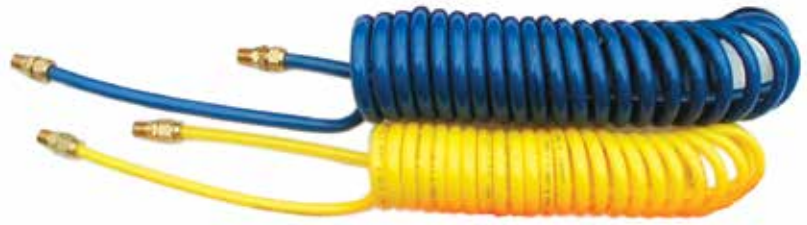

Nylon Self-Storing Air Hose

Nycoil was the inventor of the Nylon Self-Storing Air Hose in 1958. It was developed as a means to transport air from overhead piping to pneumatic tools at assembly stations while keeping the work area neat and safe. Unlike straight hose that lays on the floor or workbench and can easily become tangled, Self-Storing Hose retracts to keep the area clutter free. The user can also be more productive because the hose retracts away from the work area, giving the user more clear space and freedom of movement.

Nylon is resistant to a wide variety of chemicals making it a good choice for most industrial environments. For more information on the properties of Nylon, please view the Technical Section.

Property Overview:

- Extremely light weight – considerably lighter than traditional rubber hoses
- Economizes on space – retracts to a fraction of its working length
- Highly flexible – doesn't impede tool maneuverability
- Brass field attachable fittings - no ferrules or inserts that become deformed and have to be replaced whenever fittings are installed
- Excellent memory - coils continue to retract after repeated stretching
- Resistant to many chemicals & petroleum based products - suitable for numerous applications
- Less than 1% moisture absorption

Typical Applications:

- MRO
- Pneumatic Tools
- Transportation
- Lubrication
- Industrial Cleaning
- Robotics

We are continually developing new innovations to further enhance our product line and, as a result, reserve the right to make design, engineering or specification changes without prior notice.

Product Specifications:

Working Pressure up to 250 psi (17 bar)
Maximum pressure and temperature range are dependent on tube diameter used.

Temperature Range -40°F to +200°F (-40°C to +93°C)

***Recommended Working Length:**
up to 85% of Material Length

Packaging

Plastic bags



[Click here for CADs, Product Specifications or to Configure Parts Online](#)

Nylon Coil Fractional Inch

6ft

ØD IN	I.D. IN	BLUE	YELLOW	UNIT LENGTH FT	WORKING LENGTH FT	COIL ØD IN	WEIGHT (LBS/1000FT)
1/4	3/16	N3AS3-06	N3AS5-06	6	4.8	2-1/2	4.80
5/16	1/4	N4AS3-06	-	6	4.8	3	4.80

Nylon Coil Fractional Inch

12ft

ØD IN	I.D. IN	BLUE	YELLOW	UNIT LENGTH FT	WORKING LENGTH FT	COIL ØD IN	WEIGHT (LBS/1000FT)
1/4	3/16	N3AS3-12	N3AS5-12	12	9.6	2-1/2	4.80
5/16	1/4	N4AS3-12	N4AS5-12	12	9.6	3	6.40

Nylon Coil Fractional Inch

17ft

ØD IN	I.D. IN	BLUE	YELLOW	UNIT LENGTH FT	WORKING LENGTH FT	COIL ØD IN	WEIGHT (LBS/1000FT)
1/4	3/16	-	N3AS5-17	17	13.6	2-1/2	4.80
5/16	1/4	N4AS3-17	-	17	13.6	3	8.00

Nylon Coil Fractional Inch

25ft

ØD IN	I.D. IN	BLUE	YELLOW	UNIT LENGTH FT	WORKING LENGTH FT	COIL ØD IN	WEIGHT (LBS/1000FT)
1/4	3/16	N3AS3-25	N3AS5-25	25	20	2-1/2	7.20
5/16	1/4	-	N4AS5-25	25	20	3	9.60

Nylon Coil Fractional Inch

50ft

ØD IN	I.D. IN	BLUE	YELLOW	UNIT LENGTH FT	WORKING LENGTH FT	COIL ØD IN	WEIGHT (LBS/1000FT)
1/4	3/16	N3AS3-50	N3AS5-50	50	40	2-1/2	10.40
5/16	1/4	-	N4AS5-50	50	40	3	14.40

WARNING: These products can expose you to chemicals including NICKEL, CARBON BLACK, TITANIUM DIOXIDE, or LEAD, which are known to the state of

[Click here for CADs, Product Specifications or to Configure Parts Online](#)

Supercoil® PU Self-Storing Air Hose

SUPERCOIL® is Self-Storing Air Hose made from 95 Durometer Polyurethane. This extremely flexible hose is perfect for applications where kink and abrasion resistance are important considerations. Our contemporary looking state-of-the-art strain relief system protects the hose at its weakest point (at the barb) while enhancing the appearance of the entire assembly.

Other manufacturers use a strain relief that limits the ability of the hose to bend but ours was uniquely designed to take advantage of Polyurethane's flexibility, giving the user a much wider range of motion without the possibility of kinking. Reusable compression fittings are available for quick and easy installation without the need of any special tools. Supercoil® Hose Assemblies can be ordered with these reusable compression fittings already installed for rough environments that may require more frequent repairs. We also offer rigid fittings for additional durability on high impact or severe vibration applications.

Property Overview:

- SUPER flexible - 100% kink proof
- Rugged brass swivel fittings provide long life and minimal flow restrictions
- State-of-the-art strain relief system protects the hose and increases its maneuverability
- Low tension retractability - minimizes user fatigue
- Abrasion resistant
- Soft Polyurethane material will not mar finishes
- Strong enough to repel most oils and chemicals
- 16" tail on the working (tool) end eliminates tangling of the tool with the coils
- 8" tail on the supply end makes the connection to the air source easy

Product Specifications:

Working Pressure up to 150 psi (10 bar)
Maximum pressure and temperature range are dependent on tube diameter used.

Temperature Range -40°F to +165°F (-40°C to +74°C)

***Maximum Recommended Working Length:**
90% of Material Length

Packaging

Plastic bags

Polyurethane Coil Fractional Inch

10ft

ØD IN	I.D. IN	BLUE	YELLOW	UNIT LENGTH FT	WORKING LENGTH FT	COIL ØD IN	WEIGHT (LBS/1000FT)
5/16	3/16	—	—	10	9.2	2-1/8	8
3/8	1/4	U4103	—	10	9.2	2-1/2	8

Polyurethane Coil Fractional Inch

15ft

ØD IN	I.D. IN	BLUE	YELLOW	UNIT LENGTH FT	WORKING LENGTH FT	COIL ØD IN	WEIGHT (LBS/1000FT)
5/16	3/16	—	U3155	15	13.8	2-1/8	8.8
3/8	1/4	—	—	15	13.8	2-1/2	9.6

WARNING These products can expose you to chemicals including NICKEL, CARBON BLACK, TITANIUM DIOXIDE, or LEAD, which are known to the state of



Polyurethane 95A Mini Coil Tubing

The tight diameter of our Mini-Coils make them extremely flexible and ideal for use with robotics, instrumentation, small pneumatic tools, control circuits or any other application requiring either constant or intermittent motion. They include a pigtail on each end for easy fitting installation or connection to other devices. We offer a variety of colors for coding purposes or to be aesthetically compatible with other equipment. Custom colors, sizes and lengths are available – please contact Customer Service.

Property Overview:

- Extreme Flexibility
- Reduced Bend Radius
- Moisture Resistant
- Abrasion Resistant

Typical Applications:

- Water & Pneumatic Lines
- Spot Welders
- Machines
- Tools
- Pneumatic Plumbing
- Pick & Place Automation

Product Specifications:

Working Pressure up to 233 psi (16 bar)
Maximum pressure and temperature range are dependent on tube diameter used.

Temperature Range -40° to 165° F (-40° to 74° C)

***Recommended Working Length:**
85% of the total Length

Packaging

Plastic bags

Polyurethane 95A Mini Coil Fractional Inch

7ft

ØD IN	I.D. IN	BLUE	YELLOW	UNIT LENGTH FT	WORKING LENGTH FT	COIL ØD IN	WEIGHT (LBS/1000FT)
5/32	3/32	–	–	7	6	7/8	0.75
1/4	1/8	–	48471	7	6	1 1/2	1.75

Mini-Coils are fabricated with precision tubing that can be used with Push-to-Connect fittings and intended for applications where motion and fatigue for non flexible connection is a concern. Supplied with "pigtaills" for connection. All "tails" are 6" long on both ends. 5/32" units of lengths longer than 60" are manufactured with 1-1/8" Coil O.D. for shorter compacted length.

WARNING These products can expose you to chemicals including NICKEL, CARBON BLACK, TITANIUM DIOXIDE, or LEAD, which are known to the state of

[Click here for CADs, Product Specifications or to Configure Parts Online](#)

3000 71 00 – Tube Cutter



PART NUMBER	H IN	L IN	WEIGHT (LBS/1000FT)
3000 71 00	.98	3.11	1.09

This tool will cut all resilient plastic tube (e.g. nylon, fluoropolymer, polyurethane, braided PVC, soft rubber, etc.) from 1/8 to 1/2 and 3mm to 16mm diameter inclusive. It is designed to give a clean cut at right angles to the tube axis. A spring maintains the cutter in the closed position.

3000 71 11 – Tube Cutter for Tubing & Push-On Hose



PART NUMBER	WEIGHT (LBS/1000FT)
3000 71 11	1.09

For hoses up to 1" (25mm)
spare blade: 3000 71 11 05

3110/3330 – Caps/Manual Release Button Fractional Inch



ØD TUBE IN	NATURAL	BLACK	GREEN	RED	BLUE	YELLOW	WEIGHT (LBS/1000FT)
1/8	3110 53 00	–	3110 53 02	3110 53 03	3110 53 04	3110 53 05	.04
5/32	3110 04 00	3330 04 01	3110 04 02	3110 04 03	3110 04 04	3110 04 05	.04
3/16	3330 55 00	3330 55 01	3330 55 02	3110 55 03	3330 55 04	3330 55 05	.04
1/4	3110 56 00	3330 56 01	3110 56 02	3110 56 03	3110 56 04	3110 56 05	.04
5/16	3110 08 00	–	3110 08 02	3110 08 03	3110 08 04	3110 08 05	.04
3/8	3110 60 00	–	3110 60 02	3110 60 03	3110 60 04	3110 60 05	.04
1/2	3110 62 00	3330 62 01	3110 62 02	3110 62 03	3110 62 04	3110 62 05	.04

Metric



ØD TUBE MM	NATURAL	BLACK	GREEN	RED	BLUE	YELLOW	WEIGHT (LBS/1000FT)
4	3110 04 00	3330 04 01	3110 04 02	3110 04 03	3110 04 04	3110 04 05	.001
6	3110 06 00	3330 06 01	3110 06 02	3110 06 03	3110 06 04	3110 06 05	.001
8	3110 08 00	–	3110 08 02	3110 08 03	3110 08 04	3110 08 05	.001
10	3110 10 00	–	3110 10 02	3110 10 03	3110 10 04	3110 10 05	.001
12	3110 12 00	–	3110 12 02	3110 12 03	3110 12 04	3110 12 05	.001
14	3110 14 00	–	3110 14 02	3110 14 03	3110 14 04	3110 14 05	.001

In all sizes of the LF3000 fittings, except 3/16, the push button is an integral part of the design which makes it non-removable, and comes standard in black. For identification of the circuits, colored caps (p/n 3110) fit over the black push button.

Clip Strings for Tubing and Fittings

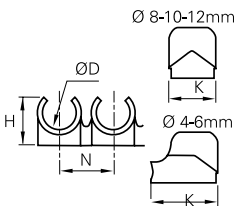

ØD TUBE	Ø LF3000 TO BE CLIPPED	PART NUMBER	H MM	K MM	N MM	NUMBER OF CLIPS PER STRING	WEIGHT (LBS/1000FT)
5/32, 4MM		CLIP 04 00	9	13.5	10.5	8	.000
1/4, 3/16, 6MM		CLIP 06 00	10.5	13	10.5	8	.000
5/16, 8MM	5/32, 4MM	CLIP 08 00	12.5	10.5	12	7	.009
3/8, 10MM	1/4, 6MM	CLIP 10 00	14	12	15	6	.010
1/2, 12MM		CLIP 12 00	16.5	14	16.5	5	.011
14MM	5/16, 8MM	CLIP 14 00	18	16	20.5	4	.011

Clip strips come complete with screws of .375 inches in length.

WARNING These products can expose you to chemicals including NICKEL, CARBON BLACK, TITANIUM DIOXIDE, or LEAD, which are known to the state of

Compatibility of Legris fittings and tubing

The chart below summarizes the compatibility of Legris fittings and tubing. In order to obtain the best performance of connection assembly, the user should take into account the individual technical specification of both the fitting and tubing.

FITTINGS	TUBING				
	NYLON SEMI-RIGID	POLYURETHANE	NYLON AND POLYURETHANE RECOIL TUBING	FLUOROPOLYMER FEP 140	POLYETHYLENE
LF3000 SYSTEM	●	●	●	●	●
FUNCTION VALVES	●	●	●	●	
LF3600 SYSTEM	●	●	●	●	●
LF3800 SYSTEM	●	●	●	●	●
BRASS COMPRESSION	●	●	●	●	●
CARTRIDGES	●	●			●
STAINLESS STEEL COMPRESSION	●	●		●	
C9000 SAFETY COUPLER	●	●	●		
METAL QUICK DISCONNECT COUPLERS	●	●	●	●	
BLOWGUNS	●	●	●		●
LIQUIFIT					●

* tube support must also be used

At high temperature and pressure or during oscillating movements, the use of a tube support prevents distortion of the tube which guarantees effective gripping and sealing.

Packaging for Tubing



Tubepack®

- 50ft, 100ft, 250ft, 25m and 100m lengths
- Easy identification of the material, size and color of tubing
- Cleaner storage in warehouse, can be stored vertically or horizontally



Reels

- 500ft
- Supplied with protective plastic film



General Technical

Manufacturing Techniques

Tube Line Fabrication Guide
for Leak Free Systems

Thread Specifications

Flaring Instructions

Thread Designations and Standards for
Threads Used in Fluid Connectors

Straight Thread Size Comparison Chart

S.A.E. Part Index

SAE Standards

U.L. Listed Fittings

Flare and Thread Profiles

Pressure Conversions

English/Metric Conversions

Assembly Guides

Fluid Compatibility Guide



GOODYEAR
RUBBER PRODUCTS, INC.

 **727-342-5088**

You can also email us at
GRP@goodyearrubberproducts.com

Manufacturing Techniques

Parker Extruded fittings

Hexagon, round and shaped bars are extruded in the configuration required, drawn to size, cut to length and straightened. First a solid round billet (8 to 12 inches in diameter) is heated to the pliable state and forced by pressure of approximately 80,000 pounds per square inch through a die. The resulting continuous length of bar is cooled and then drawn through dies to the desired external size. (The drawing process also controls the temper.) After straightening, the bar is ready for machining.

The process produces a dense, nonporous material somewhat stronger in the longitudinal direction due to an orientated flow of the grain.

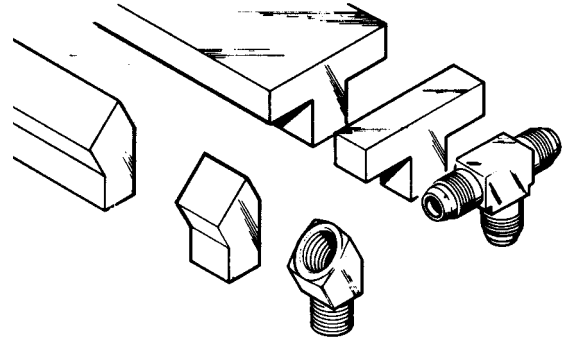

Material used for Parker Brass Fittings

(Reference SAE J461)

Straight bodies:	barstock CA 360 or CA 345
Shape bodies:	extruded barstock CA 360
Shape bodies:	forged CA 377
Nuts:	barstock CA 360
Nuts:	forged CA 377

Parker Forged Fittings

Material for forgings is extruded in round bars, cut to length and straightened. (At this point in the process, forging rod differs from round extruded machinable bars only in temper and chemical properties.) After straightening, the bars are cut again into slugs (short lengths), reheated to the pliable state and pressed under a pressure of approximately 25,000 pounds per square inch between upper and lower die cavities. After cooling the flash is trimmed away and the forging blank is ready for machining.

This process of forming under extreme pressure produces a uniformly dense material of exceptional strength. Because grain flow follows the contour, the fitting has high impact strength and is more resistant to mechanical shock and vibration.

Of the major brass fittings producers, only Parker offers elbows and tees machined from both extruded and forged shapes.

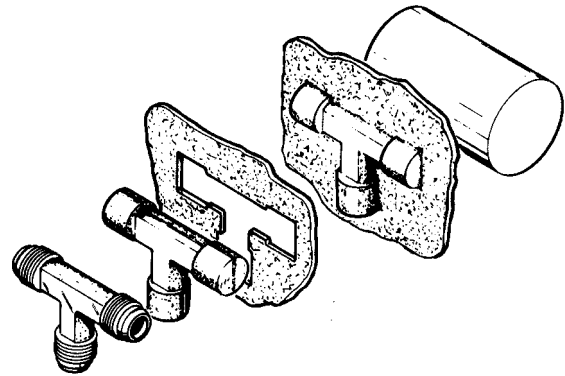

Tube Line Fabrication Guide for Leak Free Systems

Every hydraulic, pneumatic and lubrication system requires some form of tube line fabrication and fitting installation for completion. Proper fabrication and installation are essential for the overall efficiency, leak free performance, and general appearance of any system.

Start by planning ahead. After sizing the tube lines and selecting the appropriate style of fitting, consider the following in the design of your system:

1. Accessibility of joints
2. Proper routing of lines
3. Adequate tube line supports
4. Available fabricating tools

Routing of Lines

Routing of lines is probably the most difficult yet most significant of these system design considerations. Proper routing involves getting a connecting line from one point to another through the most logical path.

Always try to leave fitting joints as accessible as possible. Hard to reach joints are hard to assemble and tighten properly. Inaccessible joints are also more difficult and time consuming to service.

The most logical path should have the following characteristics:

- **Avoid excessive strain on joint** — A strained joint will eventually leak. (See Figures A14 through A21.)
- **Allow for expansion and contraction** — Use a “U” bend or a hose in long lines to allow for expansion and contraction. (See Figure A22.)
- **Allow for motion under load** — Even some apparently rigid systems do move under load. (See Figure A23.)
- **Get around obstructions without using excessive amount of 90° bends** — Pressure drop due to one 90° bend is greater than that due to two 45° bends. (See Figures A24 and A25.)
- Keep tube lines away from components that require regular maintenance. (See Figures A26 and A27.)
- Have a neat appearance and allow for easy troubleshooting, maintenance and repair. (See Figures A28 and A29.)

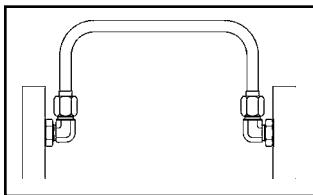

Fig. A14 — Correct Routing

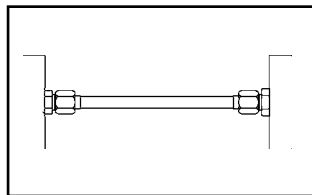

Fig. A15 — Incorrect Routing

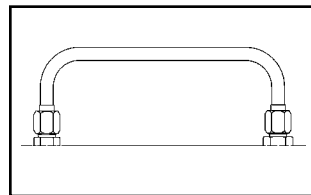

Fig. A18 — Correct Routing

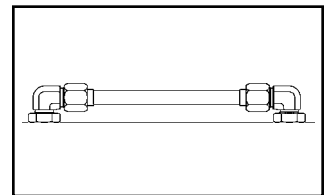

Fig. A19 — Incorrect Routing

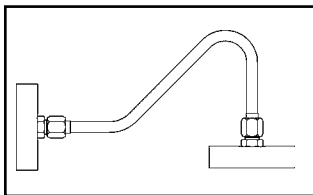

Fig. A16 — Correct Routing

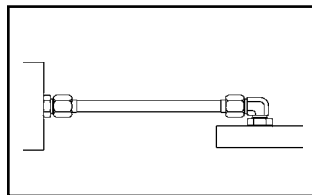

Fig. A17 — Incorrect Routing

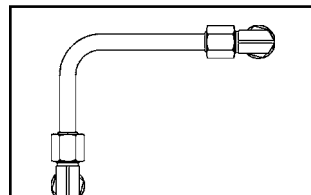

Fig. A20 — Correct Routing

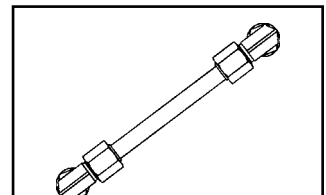

Fig. A21 — Incorrect Routing

(continued next page)

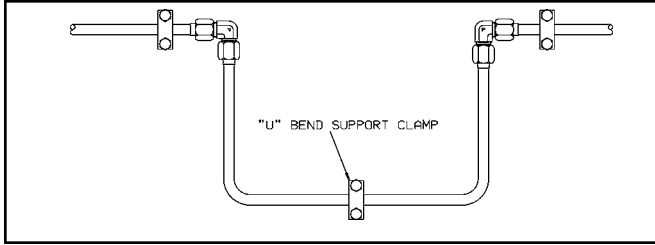

Fig. A22 — U-Bend Allowing Expansion and Contraction

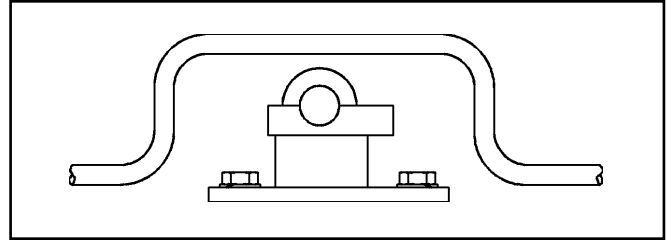

Fig. A25 — Incorrect

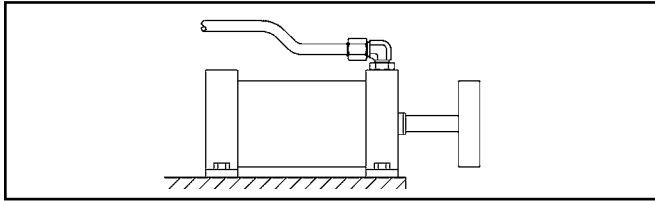

Fig. A23 — Bent Tube Allowing for Motion Under Load

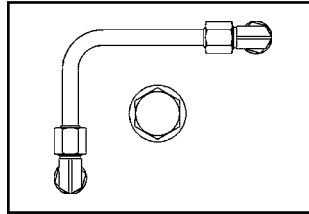

Fig. A26 — Correct

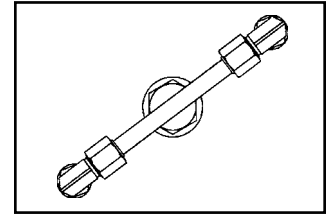

Fig. A27 — Incorrect

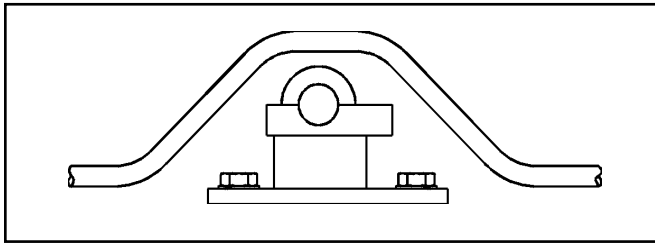

Fig. 24 — Correct

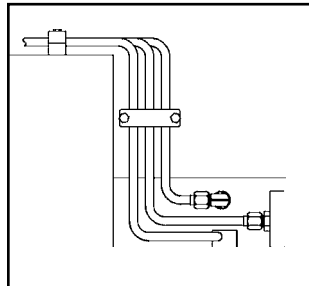

Fig. A28 — Correct

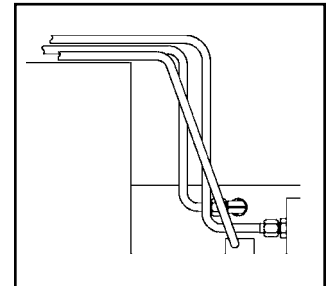

Fig. A29 — Incorrect

Thread Specifications

Dryseal Pipe Threads

All dryseal pipe threads are manufactured in accordance with the American National Standards Institute (ANSI) B1.20.3 specification and designed to seal pressure tight joints. The threads may incorporate the NPTF (National Standard Pipe Taper Fuel and Oil), PTF-SAE Short, PTF-SPL Short or PTF-SPL Extra Short form. Dryseal threads are used on brass products found within this catalog. Use of a thread sealant is recommended.

Non-Dryseal Pipe Threads

All non-dryseal pipe threads are manufactured in accordance with the American National Standards Institute (ANSI) B1.20.1 specification. These tapered pipe threads are used on our carbon and stainless steel products. Use of a thread sealant is recommended.

Nickel Plating

Nickel Plating is optional on standard product. Specifications for plating are not considered when standard product is manufactured. Since plating will alter thread pitch diameters, all plated threads should be qualified by functional fit with mating parts and not by standard thread gauging. Consult factory on plated product that will be qualified by standard thread gauging. These should be ordered as non-standards so product can be machined to pre-plated specifications.

Nickel plating provides a corrosion resistant coating which is desirable in many applications. Electrolytic nickel plating is the standard plating supplied unless otherwise specified. This will provide a uniform coverage of external surfaces; however, internal surfaces may be uncoated.

Unified Threads

All threads in the columns headed "Straight Thread" found within this catalog are manufactured in accordance with the American National Standards Institute (ANSI) B1.1 specification.

British Standard Pipe Threads BSPT and BSPP

Pressure Tight

The British pipe threaded products found within this catalog intended for use where pressure tight joints are made on the threads are manufactured in accordance with British Standard (BS) 21 and International Standards Organization (ISO) 7-1. The threads are designated as follows:

- Rp: Internal parallel
- Rc: Internal taper
- Rs: Special external parallel
- R: External taper

Use of a thread sealant is recommended with the R series thread. An elastomeric peripheral seal should be used with the Rs thread.

Non-Pressure Tight

All British Standard parallel pipe threads manufactured in this catalog according to BS2779 and ISO 228-1 are intended for use where pressure tight joints are not made on the threads. An elastomeric peripheral seal should be used. These threads are designated as follows:

- G: Internal Thread
- GA, External thread, tight tolerance classification
- GB, External thread, general purpose and assumed if no classification designation is given

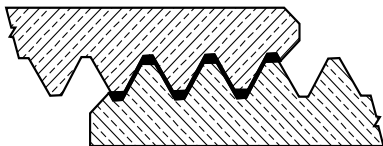

Dryseal Pipe Thread

Metal to metal contact. Crests of thread are crushed by the roots when wrench-tightened to form seal.

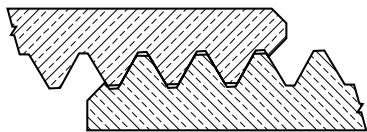

Non-Dryseal Pipe Thread

Flanks are in contact with possible clearance between the roots and crests. Will not prevent spiral leakage

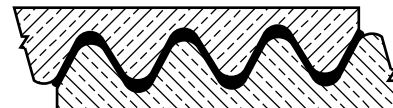

BS21 British Standard Pipe Thread for Pressure Tight Joints

Metal to metal contact provides seal as tapered thread is wrench-tightened.

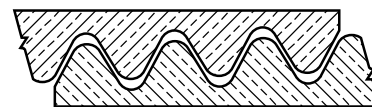

BS2779 British Standard Pipe Thread for Non-Pressure Tight Joints

Thread tolerances allow for possible clearance between threads. Will not prevent leakage paths.

Pipe Thread Assembly

The two British Standard pipe thread forms used for Parker's standard product are manufactured in a tighter tolerance range than required by the standards in order to facilitate the assembly and mating of fittings produced by the two different standards. In general, BS21 threads do not necessarily mate with BS2779 threads at tolerance overlap conditions, but fittings located within this catalog can be assembled as follows:

External Thread	Mating Internal Thread
G-BS2779 (parallel)	G-BS2779 (parallel) Rp-BS21* (parallel)
Rs-BS21 (parallel)	Rp-BS21 (parallel) G-BS2779 (parallel)
R-BS21 (taper)	Rp-BS21 (parallel) Rc-BS21 (taper) G-BS2779 (parallel)

*This thread must be manufactured within a reduced tolerance range to always assemble with the G series external thread.

British Standard ISO Metric Screw Threads

They are commonly used in miniature pneumatic applications because of the availability of small thread diameters and are also used extensively in the automotive industry. There are two forms of sealing on metric screw threads.

- O-ring sealing into a profiled port in accordance with ISO 6149.
- Peripheral sealing with a copper or bonded washer in accordance with ISO 261 and 262.

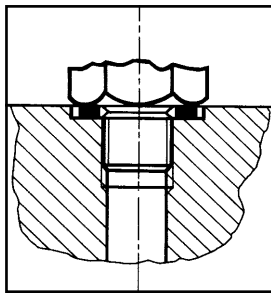

Peripheral sealing of parallel threads

Pressure-tight joints of screwed connections with parallel threads are achieved by placing a seal between the two machined faces

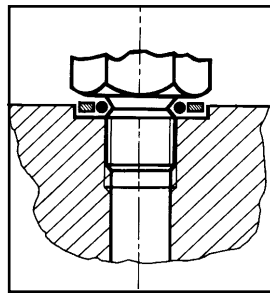

Flat seals

Washers and rings are manufactured in many different materials including copper, aluminium, fiber, plastics, etc.

The tightening torque at assembly must be carefully selected so as to avoid compressing the seal to the point of extrusion. As a general rule, the fitting should be tightened with an additional 1/4 wrench turn from the fingertight position.

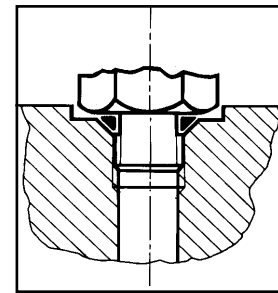

O-rings

Depending upon the configuration of the female port or male thread, O-Ring seals are fitted with or without back-up washers, and can be fully retained in a captive seal.

Flaring Instructions

In order to properly flare copping tubing for use with Parker 45° Flared Fittings and Inverted Flared Fittings, the following procedures and specifications should be met in preparation and make-up of flares.

1. Cut tube with tube cutter:

To minimize the burr and workhardening, use a light feed on the cutting wheel and make several revolutions.

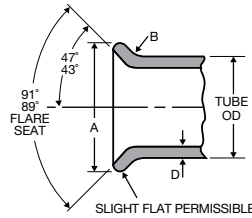

2. Ream the tubing:

Cutting with a tube cutter will always create a burr. The burr must be removed to obtain maximum sealing surface. Remove only the burr, do not remove material from the original wall thickness. Also clean the tube end thoroughly to remove burrs.

3. Flare tubing: Flare with a compression or generating type flaring tool. Follow tool manufacturer’s instructions for: (a) positioning the tube in tool and (b) for the correct number of turns on the feed handle.

4. Inspect tubing: The flare cone should be checked for a smooth surface on the i.D. Of the cone and measure with micrometer over largest o.D. For proper size. (See dimensions below for flare size for each tubing size.)

NOMINAL TUBE	A SINGLE FLARE DIAMETER		B SINGLE FLARE RADIUS	D SINGLE FLARE WALL THICKNESS
	MAX. IN	MIN. IN	+/- 0.01 IN	MAX. IN
1/8	.181	.171	.02	.035
3/16	.249	.239	.02	.035
1/4	.325	.315	.02	.049
5/16	.404	.388	.02	.049
3/8	.487	.471	.02	.065
7/16	.561	.545	.02	.065
1/2	.623	.607	.02	.083
9/16	.676	.660	.02	.083
5/8	.748	.732	.02	.095
3/4	.916	.900	.02	.109
7/8	1.041	1.025	.02	.109
1	1.157	1.141	.02	.120

Thread Designations and Standards for Threads Used in Fluid Connectors

	ABBREVIATION	DESCRIPTION	APPLICABLE STD.
STRAIGHT PIPE	NPSC	AMERICAN STANDARD STRAIGHT PIPE THREADS IN PIPE COUPLINGS	ANSI B1.20.1 FED-STD-H28/7
	NPSF	DRYSEAL AMERICAN STANDARD FUEL INTERNAL STRAIGHT PIPE THREADS (GENERALLY SED IN SOFT OR DUCTILE MATERIALS TO MATE WITH NPTF EXTERNAL TAPER THREADS)	SAE J476 ANSI B1.20.3 FED-STD-H28/8
	NPSI	DRYSEAL AMERICAN INTERMEDIATE INTERNAL STRAIGHT PIPE THREADS (FOR BRITTLE OR HARD MATERIALS; INTENDED TO MATE WITH PTF-SAE SHORT EXTERNAL TAPER THREADS)	SAE J476 ANSI B1.20.3 FED-STD-H28/8
	NPSM	AMERICAN STANDARD STRAIGHT PIPE THREADS FOR FREE-FITTING MECHANICAL JOINTS FOR FIXTURES (THESE THREADS FIT FREELY OVER NPTF THREADS. THEY ARE USED IN SWIVEL NUTS OF 07 ADAPTERS)	ANSI B1.20.1 FED-STD-H28/7
TAPER PIPE	ANPT	AERONAUTICAL NATIONAL TAPER PIPE THREADS (SIMILAR TO NPT WITH VARIOUS ADDITIONAL REQUIREMENTS IN GAGING)	MIL-P-7105
	NPT	AMERICAN STANDARD TAPER PIPE THREADS FOR GENERAL USE	ANSI B1.20.1 FED-STD-H28/7
	NPTF	DRYSEAL AMERICAN STANDARD TAPER PIPE THREADS (USED IN ALL OF OUR STEEL AND BRASS FITTINGS)	SAE J476 ANSI B1.20.3 FED-STD-H28/8
	PTF - SAE SHORT	DRYSEAL SAE SHORT TAPER PIPE THREADS (MAINLY USED IN LOW PRESSURE PNEUMATIC AND FUEL APPLICATIONS)	SAE J476 ANSI B1.20.3 FED-STD-H28/8
	PTF - SPL SHORT ¹	DRYSEAL SPECIAL SHORT TAPER PIPE THREADS	ANSI B1.20.3
	PTF - SPL EXTRA SHORT ¹	DRYSEAL SPECIAL EXTRA SHORT TAPER PIPE THREADS	ANSI B1.20.3

Continued next page

	ABBREVIATION	DESCRIPTION	APPLICABLE STD.
UNIFIED THREADS	UN	UNIFIED CONSTANT PITCH THREADS (STANDARD SERIES: 4, 6, 8, 12, 16, 20, 28, 32)	ANSI B1.1 ED-STD-H28/2
	UNC	UNIFIED COARSE THREADS	ANSI B1.1 FED-STD-H28/2
	UNEF	UNIFIED EXTRA FINE THREADS	ANSI B1.1 FED-STD-H28/2
	UNF	UNIFIED FINE THREADS	ANSI B1.1 FED-STD-H28/2
	UNS	UNIFIED SPECIAL PITCH THREADS	ANSI B1.1 FED-STD-H28/3
	UNJ	UNIFIED CONTROLLED ROOT RADIUS THREADS	ANSI B1.15 FED-STD-H28/4
METRIC THREADS	M	METRIC SCREW THREADS — M PROFILE	ISO 261 ANSI B1.13M FED-STD-H28/21
	M — KEG	METRIC TAPER THREADS (MAINLY USED IN GERMANY)	DIN 158
BRITISH STANDARD	R (BSPT)	BRITISH STANDARD TAPER PIPE THREADS, EXTERNAL	BS 21 ISO 7/1
	RC (BSPT)	BRITISH STANDARD TAPER PIPE THREADS, INTERNAL	BS 21 ISO 7/1
	RP OR G (BSPP)	BRITISH STANDARD PIPE (PARALLEL) THREADS	BS 2779 ISO 228/1
JAPANESE STANDARD	PF ²	JIS PARALLEL PIPE THREADS	JIS B202 ISO 228/1
	PT ²	JIS TAPER PIPE THREADS	JIS B203 ISO 7/1
	PS	JIS PARALLEL INTERNAL PIPE THREADS (TO MATE WITH PT THREADS)	JIS B203

Table A48 — Thread Designations and Standards for Threads Used in Fluid Connectors

- Used in some pneumatic components where shortened thread depth is required because of lack of enough material due to component size limitations.
- PF and PT threads are functionally interchangeable with BSPP and BSPT threads, respectively. These are old designations. They are being replaced with G (for PF) and R and Rc (for PT) as documents are revised.

Straight Thread Size Comparison Chart

	TUBE O.D.										
	1/8	3/16	1/4	5/16	3/8	7/16	1/2	5/8	3/4	7/8	1
SAE 45° FLARED	5/16 -24	3/8 -24	7/16 -20	1/2 -20	5/8 -18	11/16 -16	3/4 -16	7/8 -14	1-1/16 -14	1-1/4 -12	-
INVERTED FLARED	5/16 -28	3/8 -24	7/16 -24	1/2 -20	5/8 -18	11/16 -18	3/4 -18	7/8 -18	1-1/16 -16	1-3/16 -16	-
AIR BRAKE/NTA	-	-	7/16 -24	-	17/32 -24	-	11/16 -20	13/16 -18	1 -18	-	1-1/4 -16
STANDARD, COMPRESSION / COMPRESS-ALIGN	5/16 -24	3/8 -24	7/16 -24	1/2 -24	9/16 -24	5/8 -24	11/16 -20	13/16 -18	1 -18	1-1/8 -18	1-1/4 -18
POLY-TITE			3/8 -24	7/16 -24	1/2 -24	-	11/16 -20	-	-	-	-
VIBRA-LOK	3/8 -24	-	1/2 -24	9/16 -24	5/8 -24	-	13/16 -18	1 -18	1-1/8 -18	-	-
V510 BALL VALVES	-	-	7/16 -20	-	9/16 -18	-	3/4 -16	7/8 -14	1-1/16 -12	-	1-5/16 -12
HI-DUTY FLARELESS TUBE FITTINGS	5/16 -24	3/8 -24	7/16 -20	1/2 -20	9/16 -20	-	11/16 -16	7/8 -18	-	-	-

S.A.E. Part Index

<u>PART NO.</u>	<u>PAGE</u>	<u>PART NO.</u>	<u>PAGE</u>	<u>PART NO.</u>	<u>PAGE</u>	<u>PART NO.</u>	<u>PAGE</u>
SAE 010101	H8	SAE 010202.....	H10	SAE 060102 BA.....	G9	SAE 100203 BA.....	F9
SAE 010102.....	H9	SAE 010203.....	H11	SAE 060103 BA.....	G9	SAE 100302 BA.....	F9
SAE 010103.....	H9	SAE 010302	H11	SAE 060110.....	G8	SAE 100401 BA.....	F8
SAE 010104.....	H8	SAE 010401.....	H10	SAE 060111	G8	SAE 100424 BA.....	F9
SAE 010105.....	H12	SAE 010424.....	H11	SAE 060115.....	G8	SAE 100425 BA.....	F9
SAE 010106.....	H12	SAE 010425.....	H10	SAE 060201 BA.....	G10	SAE 120101 BA	F13
SAE 010107.....	H12	SAE 040101.....	H14	SAE 060202 BA	G10	SAE 120102 BA.....	F13
SAE 010108.....	H7	SAE 040102	H14	SAE 060203 BA	G11	SAE 120103 BA.....	F13
SAE 010109.....	H12	SAE 040103	H14	SAE 060401 BA	G10	SAE 120111	F13
SAE 010110	H8	SAE 040110.....	H14	SAE 060424 BA.....	G11	SAE 120115	F13
SAE 010111	H8	SAE 040202	H15	SAE 060425 BA	G11	SAE 120201 BA.....	F13
SAE 010112	H12	SAE 040203	H15	SAE 100101 BA	F7	SAE 120202 BA.....	F14
SAE 010113	H7	SAE 040302	H15	SAE 100102 BA	F8	SAE 120203 BA.....	F14
SAE 010114	H7	SAE 040401	H14	SAE 100103 BA.....	F8	SAE 120302 BA.....	F14
SAE 010165.....	H7	SAE 040424	H15	SAE 100110	F7	SAE 120401 BA.....	F13
SAE 010166.....	H7	SAE 040425	H15	SAE 100115	F7	SAE 120424 BA.....	F14
SAE 010167.....	H7	SAE 040427	H15	SAE 100201 BA.....	F8	SAE 120425 BA.....	F14
SAE 010201.....	H11	SAE 060101 BA.....	G8	SAE 100202 BA.....	F9		

SAE Standards

(Current)

- J246:** Spherical and Flanged Sleeve (Compression) Tube Fittings
Tubing: Copper and J844 Nylon
Fittings: NTA and Air Brake
- J476:** Dryseal Pipe Threads
- J512:** Automotive Tube Fittings
Tubing: Copper and Nylon
Fittings: 45° Flare, Inverted Flare, Compression
- J513:** Refrigeration Tube Fittings
Tubing: Annealed Copper
Fittings: 45° Flare
- J530:** Automotive Pipe Fittings
Fittings: Pipe
- J531:** Automotive Pipe, Filler and Drain Plugs
Fittings: Pipe Plugs
- J844:** Nonmetallic Air Brake System Tubing
Tubing: Non-reinforced Type A, reinforced Type B
- J1131:** Performance Requirements for SAE J844 Nonmetallic Tubing and Fitting Assemblies Used in Automotive Air Brake Systems
Tubing: J844 Nylon
Fittings: NTA and Prestomatic
- J1615:** Thread Sealants
- J2494:** Brass Body Push-to-Connect Fittings
Tubing: J844 Nylon
Fittings: Prestomatic

U.L. Listed Fittings

Many of the Fluid System Connectors Division's fittings have been listed by the Underwriter's Laboratory. The listings fall under 1 of 3 categories, depending upon application. Underwriter's requires that the smallest unit package carry the U.L. symbol and each carton be printed in accordance with the specification of each category.

List of U.L. Fittings

FITTINGS, FLAMMABLE LIQUID			
1F	62C	168CA	252IFHD
2GF	62CA	169C	256IF
3GF	62CABH	169CA	259IFHD
14FL	62CBH	170C	264C
14FSV	66C	170CA	264CA
14FSX	66CA	171C	265C
41FL	68C	171CA	265CA
41FS	68CA	172C	269C
41FX	144F	172CA	269CA
41IF	145F	176C	270C
41IFS	147F	176CA	270CA
42F	149F	177C	639C
42IFHD	150F	177CA	639CA
46F	151F	244F	639F
46IFHD	155F	244IFHD	640F
48F	159F	245IFHD	660FHD
48IFHD	164C	249F	661FHD
60C	164CA	249IF	664FHD
61C	165C	249IFHD	
61CA	165CA	250IFHD	
61CL	168C	251IFHD	

FITTINGS, FUEL EQUIPMENT, MARINE			
2GF	144F	155F	664FHD
3GF	145F	159F	
14FL	147F	639F	
42F	149F	640F	
46F	150F	660FHD	
48F	151F	661FHD	

SHUT-OFF VALVES, FLAMMABLE LIQUIDS, LP GAS AND COMPRESS GAS		
XV520P-4	XV520P-20	XV500P-20
XV520P-6	XV520P-24	XV500P-24
XV520P-8	XV520P-32	XV500P-32
XV520P-12	XV520P-40	
XV520P-16	XV520P-48	

Flare and Thread Profiles

SAE (JIC) 37° Flare Nose Sizes

Actual Size

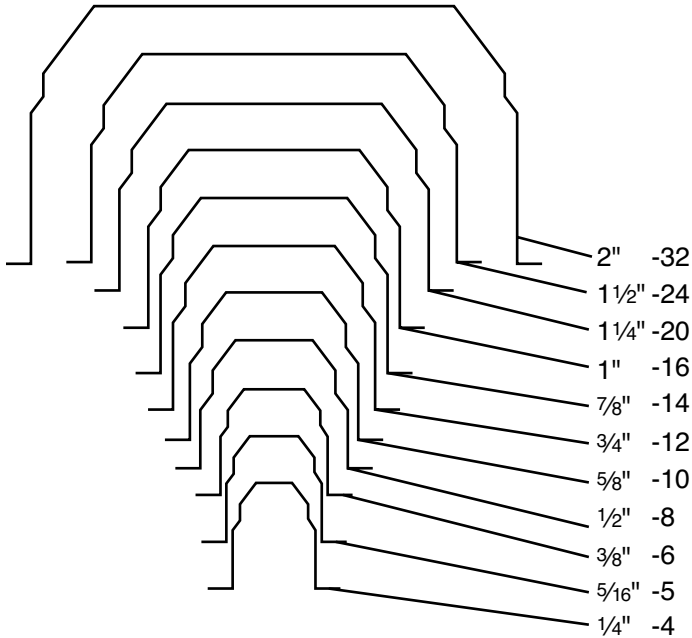

SAE 45° Flare Nose Sizes

Actual Size

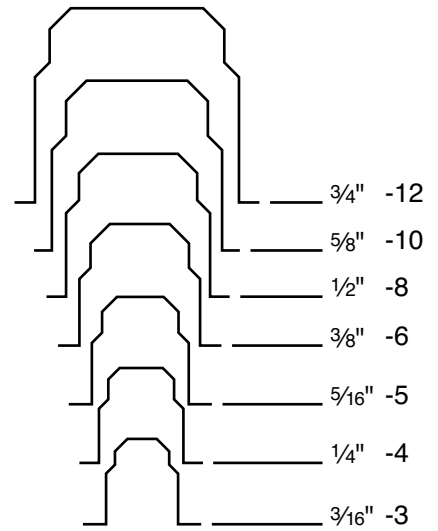

Male Pipe Thread Sizes

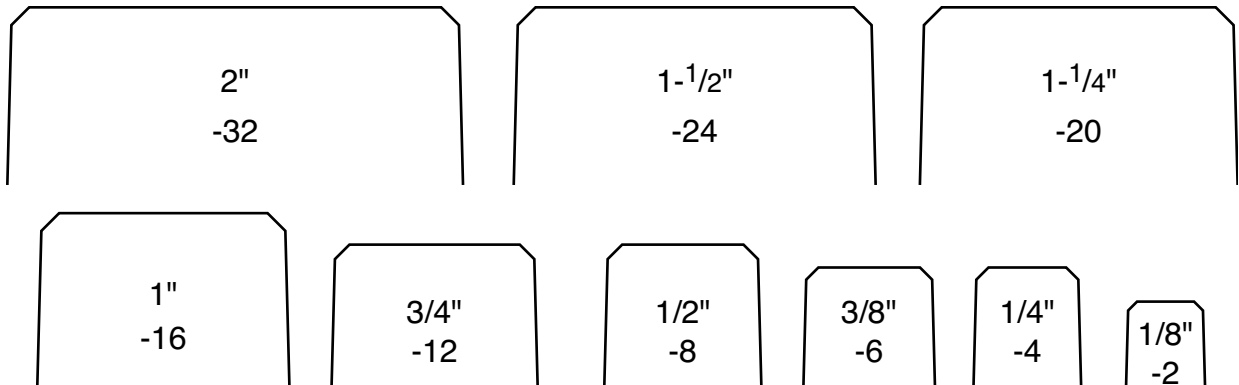

Actual Outside Diameters of Tubing

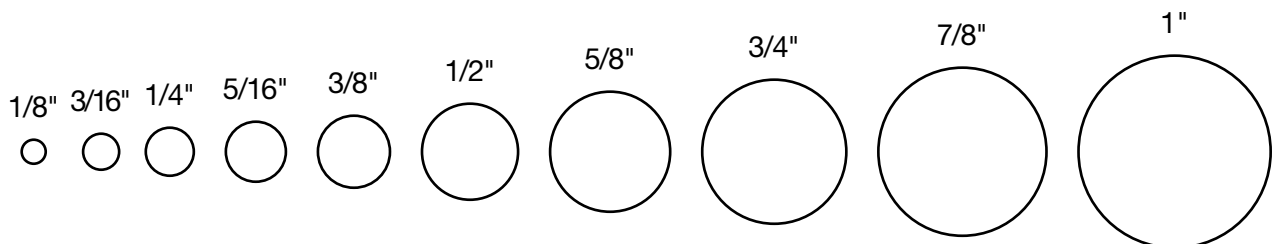

Pressure Conversions

KILOPASCALS (KPA)	MEGAPASCALS (MPA)	BAR (bar)	KILOGRAMS PER SQUARE CENTIMETER (KGF/CM2)	POUNDS PER SQUARE INCH (PSI)
100	1.0	1	1.02	14.50
200	.2	2	2.04	29.00
300	.3	3	3.06	43.50
400	.4	4	4.08	58.00
500	.5	5	5.10	72.50
600	.6	6	6.12	87.00
700	.7	7	7.14	101.50
800	.8	8	8.16	116.00
900	.9	9	9.18	130.50
1000	1.0	10	10.20	145.00
2000	2.0	20	20.40	290.10
3000	3.0	30	30.60	435.10
4000	4.0	40	40.80	580.20
5000	5.0	50	51.00	725.20
6000	6.0	60	61.20	870.20
7000	7.0	70	71.40	1015.30
8000	8.0	80	81.60	1160.30
9000	9.0	90	91.80	1305.30
10000	10.0	100	102.00	1450.00
20000	20.0	200	204.00	2901.00
30000	30.0	300	306.00	4351.00
40000	40.0	400	408.00	5802.00
50000	50.0	500	510.00	7252.00
60000	60.0	600	612.00	8702.00
70000	70.0	700	714.00	10153.00
80000	80.0	800	816.00	11603.00
90000	90.0	900	918.00	13053.00
100000	100.0	1000	1020.00	14504.00
200000	100.0	2000	2040.00	29008.00
300000	300.0	3000	3060.00	43511.00

POUNDS PER SQUARE INCH (PSI)	KILOPASCALS (KPA)	MEGAPASCALS (MPA)	BAR (bar)	KILOGRAMS PER SQUARE CENTIMETER (KGF/CM2)
10	68.90	.07	.70	.70
20	137.90	.14	1.41	1.41
30	206.80	.21	2.10	2.11
40	275.80	.28	2.80	2.81
50	344.70	.34	3.40	3.52
60	413.70	.41	4.10	4.22
70	482.60	.48	4.80	4.92
80	551.60	.55	5.50	5.63
90	620.50	.62	6.20	6.33
100	689.00	.70	6.90	7.00
200	1379.00	1.40	13.80	14.10
300	2068.00	2.10	20.70	21.10
400	2758.00	2.80	27.60	28.10
500	3447.00	3.40	34.50	35.20
600	4137.00	4.10	41.40	42.20
700	4826.00	4.80	48.30	49.20
800	5516.00	5.50	55.20	56.30
900	6205.00	6.20	62.10	63.30
1000	6895.00	6.90	68.90	70.30
2000	13790.00	13.80	137.90	140.70
3000	20684.00	20.70	206.80	211.00
4000	27579.00	27.60	275.80	281.30
5000	34474.00	34.50	344.70	351.60
6000	41369.00	41.40	413.70	421.90
7000	48263.00	48.30	482.60	492.30
8000	55158.00	55.20	551.60	562.60
9000	62053.00	62.10	620.50	632.90
10000	68948.00	68.90	689.00	703.00
20000	137895.00	137.90	1379.00	1406.00
30000	206843.00	206.80	2068.00	2110.00
40000	275790.00	275.80	2758.00	2813.00

Tube Insertion Depths

This engineering standard covers the tube insertion depths and minimum depths to pass thru the o-ring. The depths are used for conveying information to customers and are meant to be used only as a guideline.

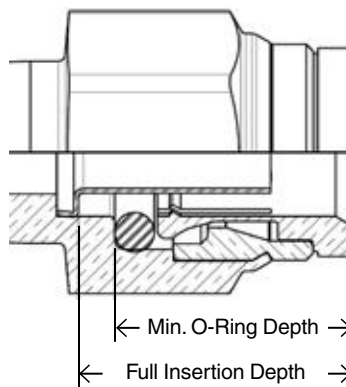
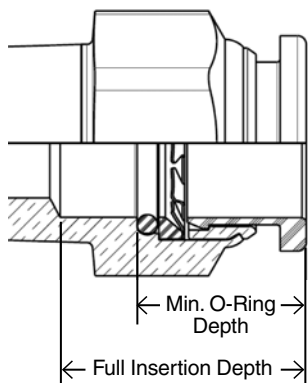

Brass Prestolok Plus (PLP Metal)

TUBE SIZE	FULL INSERTION DEPTH (IN.)	MINIMUM O-RING DEPTH (IN.)
1/8"	.64	.48
5/32"	.64	.48
3/16"	.67	.48
1/4"	.67	.49
5/16"	.77	.51
3/8"	.78	.51
1/2"	.85	.58

LF3000 (PLP Composite) & LIQUIfit

TUBE SIZE	FULL INSERTION DEPTH (IN.)	MINIMUM O-RING DEPTH (IN.)
1/8"	.46	.38
3/16"	.65	.56
1/4"	.58	.44
3/8"	.81	.62
1/2"	1.09	.84
4MM	.51	.39
6MM	.58	.45
8MM	.73	.55
10MM	.81	.62
12MM	.97	.73
14MM	1.08	.83
16MM	1.15	.89

LF3600 (PLM) & LF3800 (PLS)

TUBE SIZE	FULL INSERTION DEPTH (IN.)	MINIMUM O-RING DEPTH (IN.)
1/4"	.66	.55
3/8"	.88	.73
1/2"	.89	.74
4MM	.57	.49
6MM	.68	.57
8MM	.71	.62
10MM	.90	.75
12MM	.96	.78
14MM	1.00	.82

Carstick

TUBE SIZE	FULL INSERTION DEPTH (IN.)	MINIMUM O-RING DEPTH (IN.)
1/8"	.46	.38
1/4"	.75	.55
3/8"	.86	.68
1/2"	1.16	.92
4MM	.49	.41
6MM	.58	.49
8MM	.71	.60
10MM	.85	.67
12MM	1.00	.79

Composite PTC / PTCR

TUBE SIZE	FULL INSERTION DEPTH (IN.)	MINIMUM O-RING DEPTH (IN.)
1/4"	.58	.47
3/8"	.70	.53
1/2"	.80	.61
5/8"	.99	.72
3/4"	1.04	.83

Metric Prestomatic

TUBE SIZE	FULL INSERTION DEPTH (IN.)	MINIMUM O-RING DEPTH (IN.)
6MM	.78	
8MM	.80	
10MM	.91	
12MM	.91	
16MM	.89	

PTCCE

TUBE SIZE	FULL INSERTION DEPTH (IN.)	MINIMUM O-RING DEPTH (IN.)
1/4"	.65	.54
3/8"	.81	.72
1/2"	.94	.72
5/8"	1.00	.75
3/4"	1.00	.75

LF3800 (PLS)

TUBE SIZE	FULL INSERTION DEPTH (IN.)	MINIMUM O-RING DEPTH (IN.)
1/4"	.69	.58
3/16"	.57	.49
3/8"	.90	.75
1/2"	.93	.78
4MM	.57	.49
6MM	.67	.56
8MM	.74	.65
10MM	.91	.76
12MM	.96	.79

Brass PTC

TUBE SIZE	FULL INSERTION DEPTH (IN.)	MINIMUM O-RING DEPTH (IN.)
5/32"	.64	.44
3/16"	.62	.44
1/4"	.59	.49
3/8"	.78	.56
1/2"	.85	.63
5/8"	1.02	.80
3/4"	1.03	.82

Prestomatic

TUBE SIZE	FULL INSERTION DEPTH (IN.)	MINIMUM O-RING DEPTH (IN.)
1/4"	.63	.54
3/8"	.81	.72
1/2"	.94	.72
5/8"	1.12	.75
3/4"	1.12	.92

TrueSeal – Acetal & Kynar

TUBE SIZE	FULL INSERTION DEPTH (IN.)	MINIMUM O-RING DEPTH (IN.)
1/4"	.71	.52
5/16"	.80	.55
3/8"	.80	.55
1/2"	.90	.63

TrueSeal - PolyPropylene

TUBE SIZE	FULL INSERTION DEPTH (IN.)	MINIMUM O-RING DEPTH (IN.)
1/4"	.74	.55
3/8"	.83	.59
1/2"	.93	.66

English/Metric Conversions

Inches x 25.4 = Millimeters (mm)
 Inches x 2.54 = Centimeters (cm)
 Inches x .254 = Decimeters (dm)
 Feet x .3048 = Meters (m)
 Yards x .9144 = Meters (m)
 PSI x .0689 = Bars (bar)
 Bars x 100 = Kilopascals (kPa)
 PSI x .0069 = Megapascals (MPa)
 Pound Inches x .113 = Newton Meters (N•m)

Pound Feet x 1.356 = Newton Meters (N•m)
 Millimeters x .0394 = Inches
 Centimeters x .3937 = Inches
 Meters x 3.281 = Feet
 Meters x 1.0936 = Yards
 Bars x 14.5 = PSI Megapascals x 145 = PSI
 Newton Meters x 8.85 = Pound Inches
 Newton Meters x .737 = Pound Feet

Millimeters to Fractions to Decimals

MM	INCHES	
	FRACTION	DECIMAL
.3969	1/64	.0156
.7938	1/32	.0312
1.1906	3/64	.0468
1.5875	1/16	.0625
1.9844	5/64	.0781
2.3812	3/32	.0937
2.7781	7/64	.1093
3.1750	1/8	.1250
3.5719	9/64	.1406
3.9688	5/32	.1562
4.3656	11/64	.1718
4.7625	3/16	.1875
5.1594	13/64	.2031
5.5562	7/32	.2187
5.9531	15/64	.2343
6.3500	1/4	.2500

MM	INCHES	
	FRACTION	DECIMAL
6.7469	17/64	.2656
7.1438	9/32	.2812
7.5406	19/64	.2968
7.9375	5/16	.3125
8.3344	21/64	.3281
8.7312	11/32	.3437
9.1281	23/64	.3593
9.5250	3/8	.3750
9.9219	25/64	.3906
10.3188	13/32	.4062
10.7156	27/64	.4218
11.1125	7/16	.4375
11.5094	29/64	.4531
11.9062	15/32	.4687
12.3031	31/64	.4843
12.7000	1/2	.5000

MM	INCH	
	FRACTION	DECIMAL
13.0969	33/64	.5156
13.4938	17/32	.5312
13.8906	35/61	.5468
14.2875	9/16	.5625
14.6844	37/64	.5781
15.0812	19/32	.5937
14.4781	39/64	.6093
15.8750	5/8	.6250
16.2719	41/64	.6406
16.6688	21/32	.6562
17.0656	43/64	.6718
17.4625	11/16	.6875
17.8594	45/64	.7031
18.2562	23/32	.7187
18.6531	47/64	.7343
19.0500	3/4	.7500

MM	INCH	
	FRACTION	DECIMAL
19.4469	49/64	.7656
19.8438	25/32	.7812
20.2406	51/64	.7968
20.2375	13/16	.8125
21.0344	53/64	.8281
21.4312	27/32	.8437
21.8281	55/64	.8593
22.2250	7/8	.8750
22.6219	57/64	.8906
23.0188	29/32	.9062
23.4156	59/64	.9218
23.8125	15/16	.9375
24.2094	61/64	.9531
24.6062	31/32	.9687
25.0031	63/64	.9843
25.4000	1	1.0000

Assembly Guides

Push-to-Connect Fittings

- PLP Metal
- LF3000 / Prestolok PLP Composite
- LF3600 / Prestolok PLM
- LF3800 / Prestolok PLS
- Oscillating Elbows
- LIQUIFit
- TrueSeal
- Flow Controls
- Prestomatic
- PTC
- Metric Prestomatic
- PMH
- Polypropylene Ball Valves

1. Cut tubing squarely – maximum of 15° angle allowable.
2. Check that port or mating part is clean and free of debris.
3. Mark tubing to appropriate tube insertion length. (see Tube Insertion Chart on page N22)
4. Insert tubing until it bottoms
5. Pull on tubing to verify it is fully inserted
6. To disassemble, simply press release button, hold against body and pull tubing out of fitting.



Transportation Compression Style NTA

1. Cut tubing squarely – maximum of 15° angle allowable.
2. Check that port or mating part is clean and free of debris.
3. Insert tubing until it bottoms on seat.
4. Tighten nut with wrench until one thread remains visible on the fitting body; (this will allow for a number of remakes) or, the nut should be screwed down finger tight, then wrench-tightened as indicated in the following table.

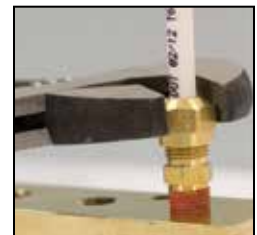

TUBE SIZE	ADDITIONAL NUMBER OF TURNS FROM HAND-TIGHT
3/16	2-1/2
1/4	3
3/8 & 1/2	4
5/8 & 3/4	3-1/2

Air Brake – AB Fittings

1. Cut tubing squarely and remove burrs
2. Slide nut and sleeve onto tubing.
3. Insert tubing into fitting until bottomed on seat. The nut should be screwed down finger tight, then wrench tightened as indicated in the chart



TUBE SIZE	TURNS REQUIRED TO SEAL FROM HAND-TIGHT
1/4, 3/8, 1/2	2
5/8, 3/4	3

Transmission Fittings

1. Cut tubing squarely and remove burrs
2. Insert tubing into fitting until bottomed
3. Tighten nut 1 1/2 turns from finger tight



Vibra-Lok

1. Cut the tubing squarely removing burrs
2. Slip nut and sleeve over tube
3. Bottom tubing into fitting and tighten nut until stop is reached. The elastic sleeve ordinarily will extrude slightly around the tube at the end of the nut. This extrusion further aids in isolating the tube from the nut.



For Higher Pressure applications

4. Consult pressure chart to determine if tubing should be belled
5. Slip nut and sleeve over tube. The sleeve should be positioned near end of tubing just behind the surface to be belled
6. Bell tubing with standard 45° flaring tool or 90° punch. The size of bell should be approximately that shown.



Air Brake Hose Ends

1. Slide nut onto hose
2. Slide sleeve onto hose with tapered edge toward fitting body
3. Bottom hose into fitting
4. Tighten nut until it contacts body hex



Note: When reassembling fitting, body and nut should be inspected. Only reuse if parts are in proper condition. Sleeves should never be Reused.

Recommended Size of Bell

TUBE O.D.	BELL DIA. C
1/8	.190-.160
3/16	.255-.225
1/4	.318-.288
5/16	.381-.351
3/8	.444-.414
1/2	.569-.539
5/8	.694-.664
3/4	.819-.789
7/8	.944-.914

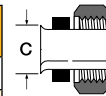

Tube Length Calculator

This table shows distance tube extends beyond face of Vibra-Lok fitting body on installation with bell on tubing and without bell on tubing.

O.D. OF TUBE	A WITH BELL	B WITHOUT BELL
1/8	3/16	3/16
3/16	3/16	7/32
1/4	3/16	1/4
5/16	3/16	1/4
3/8	3/16	1/4
1/2	3/16	11/32
5/8	3/16	TUBING SHOULD BE BELLED
3/4	3/16	
7/8	1/4	

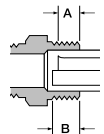

45° Flare Fittings

1. Cut tubing squarely and clean tube end thoroughly to remove burrs.
2. Place nut onto tube. Place threaded end of nut toward end of tube.
3. Flare tube end with flaring tool to provide 45° flare.
4. Clamp tube flare between nut and nose of fitting body by screwing nut on finger-tight. Tighten with a wrench an additional 1/4 to 1/2 turn past finger-tight for a metal-to-metal seal.

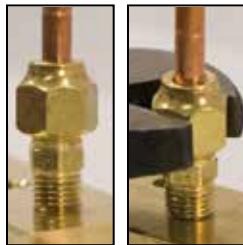

Inverted Flare

1. Cut tubing squarely and clean to remove burrs
2. Place nut onto tube. Place threaded end of nut toward end of tube.
3. Flare tube end with flaring tool to provide 45° flare
4. On thin wall copper, welded or brazed tubing, use double flare to prevent pinch-off or cracked flares
5. Clamp tube flare between nut and nose of fitting body by screwing nut on finger tight. Tighten nut with a wrench an additional 1/4 to 1/2 turn past finger tight for a metal-to-metal seal.



Dubl-Barb

Cut tube squarely and simply push tube over the two barbs



Hose Barbs

1. Cut hose cleanly and squarely to length.
2. Slide clamp on hose.
3. Lubricate hose. Push hose on fitting until bottomed against stop ring or hex.
4. Position hose clamp as shown and secure with a screwdriver or wrench. Maintain "A" dimension for proper clamp positioning.



HOSE SIZE	HOSE CLAMP	A
3/16	97 HC-3	1/4
1/4	97 HC-3	1/4
5/16	97 HC-6	1/4
3/8	97 HC-6	1/8
1/2	97 HC-8	1/8
5/8	97 HC-12	1/8
3/4	97 HC-12	1/8

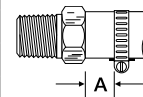

Fluid Compatibility Guide

The following pages list general recommendations for the selection of valve materials. For specific cases, and for those not included in the Fluid Compatibility Chart, it is advisable to check with your Parker representative.

There are many specific environmental factors which might affect corrosion rate such as temperature, solution,

concentration and presence of impurities. Therefore, we suggest that the information be used as a rough guide to material selection. If any questions exist regarding the expected performance of a material in a given application, actual tests should be performed to determine the suitability of the materials in question.

FLUID	BRASS	CARBON STEEL	316 S.S.	BUNA N (NITRILE)	NEOPRENE	EPR	FLUORO-CARBON	PTFE	ACETAL	NYLON
ACETALDEHYDE	P	G	E	P	G	G	P	E	U	
ACETAMINE	G	G	G	E	G			E		
ACETATE SOLVENTS	E	E	E	P			U	E	U	
ACETIC ACID VAPORS	U		U	U				E		
ACETIC ACID (10%)	P	P	E	U	P	G	U	E	U	U
ACETIC ACID (80%)	P	P	E	U	U	P	U	E	U	U
ACETIC ACID (AERATED)	P	P	E	G	G		P	E	U	
ACETIC ACID (AIR FREE)	P	P	E	G	G		U	E	U	
ACETIC ACID (CRUDE)	P	P	E	U	U		U	E	U	
ACETIC ACID (GLACIAL)			U	U	P	G	P	E		U
ACETIC ACID (PURE)	P	U	E	U	U		U	E	U	
ACETIC ANHYDRIDE	U	U	G	U	P	P	U	E	U	U
ACETONE	E	E	E	U	U	E	U	E	E	E
ACETOPHENONE	G	G	G	U	U	E	U			
ACETYL CHLORIDE	E	G	P	U	U	U	U	E		
ACETYLENE	G	E	E	G	P	E	E	E	E	
ACID FUMES	U	U	G	P	G			E		
ACRYLONITE	E	E	E	U	U	U	P	E		
AIR	E	E	E	E	E	E	E	E	E	
ALCOHOL, AMYL	G	G	E	P	P	E	G	E	E	
ALCOHOL, BUTYL	G	G	E	G	G	P	E	E	E	
ALCOHOL, DIACETONE	E	E	E	U	P	G	U	E		
ALCOHOL, ETHYL	G	G	G	E	G	E	E	E	E	
ALCOHOL, ISOPROPYL	G	G	G	P	G	E	E	E	E	
ALCOHOL, METHYL	E	G	E	G	E	E	P	E		E
ALCOHOL, PROPYL	E	G	E	G	G	E	E	E		
ALCOHOLS, FATTY	G	G	E	G	G			E		
ALUM	U		G	G	G		G	E		
ALUMINA	U		E	E	E	E		E		
ALUMINUM ACETATE	G		E	U	U	E	U	E		
ALUMINUM BROMIDE				E	E	E	E			
ALUMINUM CHLORIDE DRY	U	P	P	G	G	E	E	E	E	
ALUMINUM CHLORIDE SOLUTION			U	G	G		E	E		U
ALUMINUM FLUORIDE	U	U	P	E	E	E	E	E		U
ALUMINUM HYDROXIDE	E	U	E	E	E	E	E	E		
ALUMINUM NITRATE	U	U	P	G	G	G	U	E		
ALUMINUM OXALATE			U					E		
ALUMINUM SALTS				E	E	E	E			
ALUMINUM SULFATE	P	U	G	E	E	E	E	E	E	P
AMINES	G	G	E	U	U	P	U	E	E	
AMLY CHLORIDE	G		E	U	P	U	U	E		
AMMONIUM BICARBONATE	G	P	G	G	E	E	E	E	E	
AMMONIA, ALUM			E	G	G			E		
AMMONIA, ANHYDROUS LIQUID	U	E	E	G	P	G	U	E		
AMMONIA, AQUEOUS	U	E	E	G	G		E	E		
AMMONIA, GAS, HOT	U	G	E	P	E	E	U	E		
AMMONIA LIQUOR			E					E		
AMMONIA SOLUTIONS	U	G	E	G	G	G	U	E		
AMMONIUM ACETATE	U		G	G	G	E	U	E		
AMMONIUM BROMIDE 5%			G					E		

E-EXCELLENT

G-GOOD

P-POOR

U-UNSATISFACTORY

FLUID	BRASS	CARBON STEEL	316 S.S.	BUNA N (NITRILE)	NEOPRENE	EPR	FLUORO-CARBON	PTFE	ACETAL	NYLON
AMMONIUM CARBONATE	G	G	G	P	E	E	G	E	E	
AMMONIUM CHLORIDE	U	U	P	G	E	E	E	E	E	U
AMMONIUM HYDROXIDE 28%	U	P	G	G	E	G	E	E	E	
AMMONIUM HYDROXIDE CONC.	U	P	G	P	E	E	E	E	E	
AMMONIUM MONOSULFATE			E				E	E		
AMMONIUM NITRATE	U	U	E	E	E	E	E	E	E	U
AMMONIUM OXALATE 5%			E				E	E		
AMMONIUM PERSULFATE	P	U	E	U	P	G	G	E		U
AMMONIUM PHOSPHATE	U	U	G	E	E	E	E	E	G	P
AMMONIUM PHOSPHATE DI-BASIC	P	U	G	E	E		E	E	E	
AMMONIUM PHOSPHATE TRI-BASIC	P	U	G	E	E		E	E	E	
AMMONIUM SULFATE	P	P	G	E	E	E	G	E	E	U
AMMONIUM SULFIDE	U	U	G	E	G	E	U	E		
AMMONIUM SULFITE	P	P	E	G	E	G	E	E	E	
AMYL ACETATE	G	P	G	U	U	G	U	E	G	P
AMYL BORATE				E	E	U	E			
AMYL CHLORONAPHTHALENE				U	U	U	E			
AMYL NAPHTHALENE				U	U	U	E			
ANILINE	U	P	G	U	U	P	P	E	E	P
ANILINE DYES	P	P	E	P	P	P	G	E	E	
ANIMAL OIL	G	G	G	E	G	G	E			
ANTIMONY TRICHLORIDE	U	U	U	P			G	E		
APPLE JUICE	P	U	G	E	E	G	E	E		
AQUA REGIA (STRONG ACID)	U	U	G	U	U	U	U	E		U
AROCLOR 1248	G	U	U	U	U	G	E			
AROCLOR 1254	G	U	U	U	U	G	E			
AROCLOR 1260	G	U	U	E	E		E			
AROMATIC SOLVENTS	E	P	E	U	U	U		E		
ARSENIC ACID	U	U	G	E	E	G	E	E	E	U
ASPHALT EMULSION	E	G	E	U	P	U	E	E	E	
ASPHALT LIQUID	E	G	E	P	P	U	E	E	E	
ASTM OIL, NO. 1	E	E	E	E	E	U	E			
ASTM OIL, NO. 2	E	E	E	E	G	U	E			
ASTM OIL, NO. 3	E	E	E	E	U	U	E			
ASTM OIL, NO. 4	E	E	E	E	U	U	E			
ASTM REFERENCE FUEL A	U	G	E	E	G	U	E			
ASTM REFERENCE FUEL B	U	G	E	E	U	U	E			
ASTM REFERENCE FUEL C	U	G	E	G	U	U	E			
BARIUM CARBONATE	G	G	G	G	E	E	E	E	E	
BARIUM CHLORIDE	G	P	G	E	E	E	E	E	E	E
BARIUM CYANIDE	P		G	G	G	G	G	E		
BARIUM HYDRATE	U		E				E	E		
BARIUM HYDROXIDE	P	P	G	E	E	G	E	E	E	
BARIUM NITRATE			E		G			E		
BARIUM SALTS				E	E	E	E			
BARIUM SULFATE	P	P	E	E	E	G	E	E	E	E
BARIUM SULFIDE	U	P	G	E	G	E	E	E	E	
BEER	G	U	E	G	G	G	E	E	E	U
BEET SUGAR LIQUORS	E	G	E	E	E	G	E	E	E	
BENZALDEHYDE	E	E	E	U	U	E	U	E	E	E
BENZENE	G	G	G	U	U	U	G	E		E
BENZENESULFONIC ACID, 10%	U	U	U	U	G	U	E			
BENZLY CHLORIDE	U	U	G	U	U	U	E			
BENZOIC ACID	G	U	G	P	P	U	G	E		P
BENZYL ALCOHOL		U	E	U	G	G	E			
BERYLLIUM	G		G	G	G	G	G	E		
BLEACH LIQUOR				U	G	E	E			
BLEACHING POWDER WET	G		P	U	E	G	G	E	E	
BLOOD	G		E	G	G	G	G	E		
BORAX	U	P	E	G	U	E	E	E	E	E
BORAX LIQUORS	E	P	G		P	E	E	E	E	
BORDEAUX MIXTURE			E				E	E	E	
BORIC ACID	P	U	G	G	G	G	E	E	E	G
BRAKE FLUID	G		G	U	P	G	U	E		
BRINES, SATURATED	G	U	G	E	G	E	E	E	E	
BROMINE, DRY	G	U	U	U	U	U	G	E		
BROMINE, WET	U	U	U	U	U	U	G	E		

E-EXCELLENT

G-GOOD

P-POOR

U-UNSATISFACTORY

FLUID	BRASS	CARBON STEEL	316 S.S.	BUNA N (NITRILE)	NEOPRENE	EPR	FLUORO-CARBON	PTFE	ACETAL	NYLON
BUNKER OILS (FUEL)	G	G	E	G	G		E	E	E	
BUTADIENE	P	G	E	P	P	P	G	U		
BUTANE	E	G	E	G	G	U	E	E	E	
BUTTER	G	U	E	G	G			E		
BUTTERMILK	U	U	E	E	E	G	E	E	E	
BUTYL ACETATE	G	U	G	U	U	U	U	E		E
BUTYL ALCOHOL	E	P	E	G	G		G	E		
BUTYL AMINE	G	G	E	U	U		U	E		
BUTYL BUTYRATE				U	U	E	E			
BUTYL CARBITOL	E	P	E	U	U		U	E		
BUTYL CELLOSOLVE	E	P	E	U	U		G	E		
BUTYL STEARATE				G	U	U	E			
BUTYLENE	E	E	E	U	U	U	U	E		
BUTYRIC ACID	P	U	G	P	P	P	P	E	E	U
CALCINE LIQUORS				E		E	E			
CALCIUM ACETATE				G	G	E	U			
CALCIUM BISULFITE	P	U	G	E	E	U	E	E	E	
CALCIUM CARBONATE	P	U	G	E	E	G	E	E	E	
CALCIUM CHLORATE	U		G	G	G	G	G	E		
CALCIUM CHLORIDE	G	P	G	E	E	G	E	E	E	U
CALCIUM HYDROXIDE	P	P	G	E	G	E	E	E	E	
CALCIUM HYPOCHLORITE	U	U	P	P	P		E	E	E	U
CALCIUM NITRATE			G	G	G	G	G	E		
CALCIUM PHOSPHATE	P		G	G	G	G	G	E		
CALCIUM SALTS				E	E	E	E			
CALCIUM SILICATE	P		G	G	G	G	G	E		
CALCIUM SULFATE	P	P	G	E	E	G	E	E	E	U
CALCIUM SULFIDE	U	U	G	E	E	E	E			
CALICHE LIQUOR		G		G	G			E		
CAMPHOR	P		E	G	G	G	G	E		
CANE SUGAR LIQUORS	G	G	E	G	G	G	G	E		
CARBOLIC ACID	U	U	G	G	G	G	E	E	U	
CARBON BISULFIDE	P	G	G	U	U	U	E	E	E	
CARBON DIOXIDE, DRY	E	E	E	P	G	G	G	E	E	
CARBON DISULFIDE	U	P	E	U	U		E	E	E	
CARBON MONOXIDE	E	E	E	G	U	G	G	E		
CARBON TETRACHLORIDE, DRY	P	G	E	U	U	U	G	E	E	
CARBON TETRACHLORIDE, WET	U	U	G	U	U	U	G	E	E	
CARBONATED BEVERAGE	G	U	G	U	G	G	G	G		E
CARBONATED WATER	G	G	E	E	E	E	E	E	E	
CASEIN	P			G	G	G	G	G	E	
CASTER OIL	E	G	E	E	G	G	E	E	E	
CAUSTIC POTASH			E	G	G			E		
CAUSTIC SODA		G	E	P		G	G	E		
CELLULOSE ACETATE	G		G	U	U	G	U	E		
CELLULUBE	E		E	U	U		U	E		
CHINA WOOD OIL	P	P	E	E	G	U	E	E	E	
CHLORACETIC ACID	P	U	U	U	P		P	E		U
CHLORINATED SOLVENTS	P	P	E	U	U	U	P	E	E	
CHLORINATED WATER	U	P	G	E		E	E	E	U	U
CHLORINE, WET	U	U	U	U	U			E		
CHLORINE GAS	P	G	G	P	U	U	G	E	E	
CHLORO BROMO METHANE	G	U	G	U	U		G	E		
CHLOROBENZENE, DRY	G	G	E	U	U	U	E	E	E	E
CHLOROBUTADIENE				U	U	U	E			
CHLOROFORM, DRY	G	G	E	U	U	U	G	E	E	U
CHLOROPHYLL, DRY	G		G	G	G	G	G	E		
CHLOROSULFONIC ACID, DRY	P	G	G	U	U	U	U	E		U
CHLOROSULFONIC ACID, WET	U	U	U	U	U		P	E		
CHLORPHENOL				U	U	U	E			
CHROME ALUM	P	G	E	G	G	G	G	E		
CHROMIC ACID <50%	U	U	P	U	U	P	P	E	U	U
CHROMIC ACID >50%	U	U	P	U	U	P	P	E		
CHROMIUM SULFATE	P		G	G	G	G	G	E		
CIDER			E					E		
CITRIC ACID	P	U	G	G	E	G	E	E		P
CITRUS JUICES	G	U	G	E	E		E	E	E	

E-EXCELLENT

G-GOOD

P-POOR

U-UNSATISFACTORY

FLUID	BRASS	CARBON STEEL	316 S.S.	BUNA N (NITRILE)	NEOPRENE	EPR	FLUORO-CARBON	PTFE	ACETAL	NYLON
COCA-COLA SYRUP			E	G	G		G	E		
COCONUT OIL	G	P	E	E	P	E	E	E	E	
COFFEE	E		G	E	E	E	E	G		
COFFEE EXTRACTS, HOT	G	P	E					E		
COKE OVEN GAS	P	G	E	P	U	U	G	E		
COOKING OIL	G	G	E	E	G	U	E	E	E	
COPPER ACETATE	U	U	E	P	P	G	U	E		
COPPER CARBONATE			E					E		
COPPER CHLORIDE	U	U	P	G	G		E	E		U
COPPER CYANIDE	U		E	E	E	G	G	E		E
COPPER NITRATE	U	U	G	E	E	G	E	E	E	U
COPPER SALTS					E	E	E	E		
COPPER SULFATE	U	U	G	E	E	E	E	E	E	P
CORN OIL	G	P	G	E	P	P	E	E	E	
COTTONSEED OIL	G	P	G	E	G	P	G	E	E	
CREOSOTE OIL	G	G	G	P	U	U	E	E		U
CREOSOLS	U	G	G	U	U	U	U	E		
CRESYLIC ACID	P	P	G	U	U	U	G	E	U	U
CRUDE OIL, SOUR	P	G	E	E	G	U	E	E		
CRUDE OIL, SWEET	G	G	E	E	G		E	E		
CUPRIC NITRATE			E					E		
CUTTING OILS, WATER EMULSIONS	E	G	E	E	G		E	E		E
CYANIDE PLATING SOLUTION	U		G	G	G	G	G	E		
CYCLOHEXANE	E	E	E	P	U	U	E	E	E	
CYCLOHEXANONE	G		E	U	U			E		
DECANE				E	U	U	E			
DENATURED ALCOHOL				E	E	E	E			
DETERGENTS, SYNTHETIC	G	U	G	G	G	G	E	E		
DEXTRIN	G		G	G	G	G	G	E		
DIACETONE ALCOHOL	E	E	E	U	P			E		
DICHLOROETHANE			P	U	U	U		E		
DICHLOROETHYL ETHER	G		G	U	U	U	U	E		
DIESEL OIL FUELS	E	E	E	E	P	U	E	E		
DIETHYL BENZENE			G	U	U	U		E		
DIETHYL SULFATE	G		G	P	P	P	G	E		
DIETHYLAMINE	G	E	E	G	P	P	U	E		
DIETHYLENE GLYCOL	G	E	E	E	E	E	G	E		
DIMETHYL FORMAMIDE	G		E	G	U	U	U	E		
DIMETHYL PHTHALATE			U	G	G		U	E		
DIOCTYL PHTHALATE	E		E	P	U	U	P	E		
DIOXANE	G		G	U	U	P	U	E		
DIPENTANE	E		E	G	U	U	G	E		
DISODIUM PHOSPHATE			G	G	G		G	E		
DOW CHEMICAL HD50-4					G	E	U			
DOW CORNING 200, 510, 550				G	E	E	E			
DOWTHERM	E	G	E	U	U	U	E	E	E	
DRILLING MUD	G	G	E	E	P	E	E	E	E	
DRY CLEANING FLUIDS	P	G	E	U	U		G	E	E	
DRYING OIL	P	P	G	E	G			E	E	
ENAMEL	E		E	G	G	U		E		
EPSOM SALTS	G	P	G	E	E		E	E	E	
ETHANE	G	P	G	E	G	U	E	E	E	
ETHANOL	E	U	U	U	E	E	U			
ETHANOLAMINE	U	G	E	G	P		U	E		
ETHERS	G	E	E	U	U	P	P	E	P	
ETHYL ACETATE	P	G	G	U	U	P	U	E	E	E
ETHYL ACRYLATE	G	P	E	U	U	P	U	E		
ETHYL ALCOHOL	G	G	G	E	E		E	E		
ETHYL BENZENE			G	P	U	U		E	E	
ETHYL BROMIDE	E		G	G	G	G	G	E		
ETHYL CHLORIDE, DRY	G	G	E	P	P	P	G	G	E	E
ETHYL CHLORIDE, WET	P	U	E	P	P	G	G	E		
ETHYL ETHER	G		E	U	U	U	U	E		
ETHYL HEXANOL			E	E	E	E	E			
ETHYL SILICATE	G		G	G	P	G	G			
ETHYL SULFATE			G	G	G	P	E	E	E	

E-EXCELLENT

G-GOOD

P-POOR

U-UNSATISFACTORY

FLUID	BRASS	CARBON STEEL	316 S.S.	BUNA N (NITRILE)	NEOPRENE	EPR	FLUORO-CARBON	PTFE	ACETAL	NYLON
ETHYLENE CHLORIDE			E	U	E		U	E		
ETHYLENE DICHLORIDE	U	U	G	U	U		U	E		
ETHYLENE GLYCOL	G	G	G	E	G		E	E		
ETHYLENE OXIDE	P	G	G	U	U		U	E		
FATTY ACIDS	P	U	E	G	G		U	E	E	U
FERRIC CHLORIDE	U	U	U	E	U		E	E		U
FERRIC HYDROXIDE			E	G				E		
FERRIC NITRATE	U	U	P	E	E	E	E	E	E	U
FERRIC SULFATE	U	U	G	E	E	E	E	E	E	U
FERROUS AMMONIUM CITRATE			G					E		
FERROUS CHLORIDE	G	U	U	E	E	E	E	E	E	U
FERROUS SULFATE	G	U	G	E	E	E	E	E	E	U
FERROUS SULFATE, SATURATED	P	P	E	P	P	G	G	E		
FERTILIZER SOLUTIONS	P	G	G	G	G			E	G	
FISH OILS	G	G	E	E	G	U	E	E	G	
FLUE GASES	G		E	P	P	U	P	E	P	
FLUOBORIC ACID			G	E	G			E		U
FLUORINE, DRY	U		U	U					E	
FLUOROSILICIC ACID	G	U	G	P	P	P	P	E		U
FOOD FLUIDS & PASTES	G	P	E	G	E			E		
FORMALDEHYDE, COLD	E	E	E	G	P	G	U	E	E	U
FORMALDEHYDE, HOT	G	U	P	G	G			E	E	U
FORMIC ACID, COLD	G	U	G	U	G		G	E	U	E
FORMIC ACID, HOT	G	U	G	U	E		E	E	U	
FRUIT JUICES	G	U	E	E	E	E	E	E	E	
FUEL OIL	G	G	E	E	P	U	E	E	E	
FUMARIC ACID				G	G			E		
FURFURAL	E	E	E	U	P	P	U	E	E	E
GALIC ACID 5%	P	U	G	G	G	P	E	E	E	
GAS, NATURAL	G	G	E	E	E	U	E	E	E	
GAS, ODORIZERS	E	G	G	G	G			E	E	
GAS MFG.	G	G	G	E				E	E	
GASOLINE, AVIATION	E	E	E	P	U			E	E	E
GASOLINE, LEADED	E	E	E	P	U			E	E	
GASOLINE, MOTOR	E	E	E	P	U	U		E	E	
GASOLINE, REFINED	G	G	E	P	P	U		E	E	
GASOLINE, SOUR	G	G	E	P	U	U		E	E	
GASOLINE, UNLEADED	E	E	E	P	U			E	E	E
GELATIN	E	U	E	E	E	E		E	E	
GLUCOSE	E	G	E	E	E	E		E	E	
GLUG	E	G	E	E	G	E		E	E	
GLYCERINE	G	P	E	P	U	E	G	E	P	E
GLYCOL	G	P	G	G	E	E	E	E	P	
GLYCOL AMINE	U		G	E		U	U			
GRAPHITE	G		G	G	G	G	G	E		
GREASE	P	E	E	E	G	U	E	E		
GULF-FR FLUID, EMULSION			E	E	G	U	E			
GULF-FR FLUID G			E	E	E	E	E			
GULF-FR FLUID P			U	U	U	G	G			
HELIUM GAS	G	E	E	G	G	G	G	E		
HEPTANE	E	G	E	E	G	U	E	E	E	
HEXANE	G	G	E	E	P	U	E	E	E	E
HEXANOL, TERTIARY	E	E	E	E	P	U	G	E	E	
HEXYL ALCOHOL	E	P	E	U	P		E	E		
HYDRAULIC OIL, PETROLEUM BASE	G	E	E	E	G	U	E	E	E	
HYDRAZINE	U	U	G	P	P	G	U	E		
HYDRIGEN SULFIDE, DRY	P	G	E	P	E	E	E	E		
HYDROCHLORIC ACID, AIR FREE	U	U	U	G	P		E	E		U
HYDROCYANIC ACID	U	U	E	G	G	G	E	E	U	
HYDROFLUORIC ACID	U	U	U		G					U
HYDROFLUOSILICIC ACID	E	U	P	G	G	G	E	E		U
HYDROGEN GAS, COLD	G	G	E	G	G	G	E	E		
HYDROGEN GAS, HOT	G	G	G	G	G		E	E		
HYDROGEN PEROXIDE, CONCENTRATED	U	U	G	U	U	G	G	E		U
HYDROGEN PEROXIDE, DILUTE	P	U	G	E	G	G	E	E	G	U
HYDROGEN SULFIDE, WET	U	P	G	P	G	G	E	E	E	

E-EXCELLENT

G-GOOD

P-POOR

U-UNSATISFACTORY

FLUID	BRASS	CARBON STEEL	316 S.S.	BUNA N (NITRILE)	NEOPRENE	EPR	FLUORO-CARBON	PTFE	ACETAL	NYLON
HYDROLUBE				E	G	E	E			
HYPO (SODIUM THIOSULFATE)	P	U	G	E	E	E	E	E	E	
HYPOCHLORITES, SODIUM	U	U	P	P			E	E		
ILLUMINATING GAS	E	E	E	P	P	U	E	E		
INK, NEWSPRINT	P	U	E	E	G	G	E	E	E	
IODINE, WET	U	U	U	G			E	E		
IODIFORM	P	G	E				E	E	E	
ISOPROPYL ACETATE			G	U	U	U		E		
ISOPROPYL ALCOHOL	G	G	G	P	G		E	E		
ISOPROPYL ETHER	E	E	E	P	P	U	U	E		
ISO-BUTANE			G	G	U	U		E		
ISO-OCTANE	E	E	E	E	P	U	E	E		E
J P-4 FUEL	E	E	E	E	P		E	E	E	
J P-5 FUEL	E	E	E	G	P		E	E	E	
J P-6 FUEL	E	E	E	E	P		E	E	E	
KEROSENE	E	G	E	E	P	U	E	E	E	
KETCHUP	U	U	E	E	E		E	E	E	
KETONES	E	E	E	U	U	U	U	E	E	
LACTIC ACID, CONC. COLD	U	U	E	G	E	G	E	E	U	U
LACTIC ACID, CONC. HOT	U	U	G	P	P	G	G	E	U	U
LACTIC ACID, DILUTE COLD	U	U	E	G	E	G	E	E	U	U
LACTIC ACID, DILUTE HOT	U	U	E	P	U		U	E	U	U
LACTOSE	G		G	G	P	G	G	E		
LAQUER	E	P	E	U	U	U	U	E	E	E
LARD	G	E	E	G	P	P		E		
LARD OIL	G	P	G	E	G	G	E	E	E	
LEAD ACETATE	P	U	G	E	G	G	G	E	E	E
LEAD SULFATE	P		G	G	G	G	G	E		
LECITHIN	P		G	U	U	U	G	E		
LINOLEIC ACID	G	G	E	G	G	U	G	E	E	
LINSEED OIL	G	E	E	E	P	U	E	E	E	
LITHIUM CHLORIDE	G		G	G	G	G	G	E		
LPG	E	G	G	E	G	U	E	E	E	
LUBRICATING OIL	G	E	E	E	G	U	E	E	E	
LUDOX	U		G	G	G	G	G	E		
MAGNESIUM BISULFATE	G	G	E	G	G	G	G	E		
MAGNESIUM BISULFIDE	U		G	G	G	G	G	E		
MAGNESIUM CARBONATE	G		G	E	G	G	G	E		
MAGNESIUM CHLORIDE	G	P	E	E	E	E	E	E	E	E
MAGNESIUM HYDROXIDE	G	G	E	E	E	E	E	E	E	
MAGNESIUM HYDROXIDE HOT	U	G	E	G	G		E	E	E	
MAGNESIUM NITRATE			E	G	E		G	E		E
MAGNESIUM SALTS				E	E	E	E			
MAGNESIUM SULFATE	G	G	E	E	E	E	E	E	E	E
MALEIC ACID	G	G	G	G	G	U	E	E	E	
MALEIC ANHYDRIDE	G		G	U	U	U	G	E		
MALIC ACID	G	U	G	E	G		E	E	E	
MALT BEVERAGES			E	E	E	G	E	E		
MANGANESE CARBONATE			G	G				E		
MANGANESE SULFATE	G		E	G	G	G	G	E		
MAYONNAISE	U	U	E	E	E		E	E	E	
MEAT JUICES	U		E	G	G			E		
MELAMINE RESINS			P	G	G			E		
MERCURIC CHLORIDE	U	U	G	E	G	E	E	E		
MERCURIC CYANIDE	U	U	E	E	G		E	E		
MERCUROUS NITRATE	U		E				G	E		
MERCURY	U	E	E	E	E	E	E	E		E
METHANE	E	G	E	E	G		E	E		
METHANOL	E	E	E	E	E	E	U		E	
METHANOL	G		E	G	G	U	G	E		
METHYL ACETATE	E	G	E	U	U	G	U	E		
METHYL ACETONE	E	E	E	E	U	E	U	E		
METHYL ALCOHOL	G	G	G	E	G		P	E		E
METHYL BROMIDE 100%	P	G	G	G	U	U	G	E		
METHYL CELLOSOLVE	E	G	E	P	U	G	U	E		
METHYL CELLULOSE			E	U	U			E		
METHYL CHLORIDE	G	G	E	U	U	U	G	E	E	

E-EXCELLENT

G-GOOD

P-POOR

U-UNSATISFACTORY

FLUID	BRASS	CARBON STEEL	316 S.S.	BUNA N (NITRILE)	NEOPRENE	EPR	FLUORO-CARBON	PTFE	ACETAL	NYLON
METHYL ETHER				E	U	U	E			
METHYL ETHYL KETONE	E	E	E	U	U	G	U	E	E	E
METHYL FORMATE	E	P	G	U	G	G	U	E		
METHYL ISOBUTYLE KETONE			E	U	U			E		
METHYLAMINE	U	G	E	U	U	G	U	E		
METHYLENE CHLORIDE	E	G	E	U	U	U	P	E		U
MILK & MILK PRODUCTS	G	U	E	E	E	E	E	E	E	
MIL-F-81912, JP-9	E	E	E	U	U	U	E			
MIL-H-5606	E	E	E	E	G	U	E			
MIL-H-6083	E	E	E	E	E	U	E			
MIL-H-7083	E	E	E	E	G	E	G			
MIL-H-8446	G	E	E	G	E	U	E			
MIL-L-2104 & 2104B	E	E	E	E	G	U	E			
MIL-L-7808	U	G	E	G	U	U	E			
MINE WATERS, ACID	P	U	P	E			E	E		
MINERAL OILS	G	G	E	E	G	U	E	E	E	
MINERAL SPIRITS	G	G	G	E	P		E	E	E	
MIXED ACIDS, COLD	U	P	G	U	U	U	G	E	U	
MLO-7277 & MLO-7557	G	E	E	U	U	U	E			
MOBILE HF	E	E	E	E	G	U	E			
MOLASSES, CRUDE	E	E	E	E	E		E	E	E	
MOLASSES, EDIBLE	E	P	E	E	E		E	E	E	
MOLYBDIC ACID			E				E	E	E	
MONOCHLORO BENZENE DRY			G	U	U			E		
MONOMETHYL HYDRAZINE				G	G	E				
MORPHOLINE	G		E	U	U	G	U	E		
MURIATIC ACID	U	U	U	G			E	E		
MUSTARD	E	G	E	E	E		E	E	E	
NAPHTHENIC ACID	G	E	G	G	U	U	E			
NAPTHA	G	G	G	G	P	U	E	E	E	
NAPTHALENE	G	G	G	U	U	U	E	E	E	
NATURAL GAS, SOUR	G	G	E	E	E	U	E	E		
NEATSFOOT OIL				E	U	G	E			
NICKEL ACETATE	U	G	E	G	G	E	U			
NICKEL AMMONIUM SULFATE	U	U	E	E	G	G	U	E		
NICKEL CHLORIDE	U	U	G	E	E	G	E	E	E	E
NICKEL NITRATE	U	U	G	E	E	E	E	E	E	
NICKEL SALTS				E	G	E	E			
NICKEL SULFATE	U	U	G	E	E	G	E	E	E	E
NITRIC ACID 100%	U	U	E	U	U	U	G	E	U	U
NITRIC ACID 10%	U	U	E	P	G		E	E	U	U
NITRIC ACID 30%	U	U	E	P	P	G	E	E	U	U
NITRIC ACID 80%	U	U	P	U	U	U	G	E	U	U
NITRIC ACID ANHYDROUS	U	U	E	U	U	U	E	E		
NITROBENZENE	U	G	E	U	U	P	P	E		E
NITROGEN	E	E	E	E	E	G	E	E	E	
NITROUS ACID 10%	U	U	G	P	E		E	E	E	
NITROUS GASES	U	G	E					E		
NITROUS OXIDE	G	G	G	G	G		E	E		
NOCOTINIC ACID	E	G	E	U	U	U	G	E		
OCTYL ALCOHOL	E	E	E	G	G		E			
OILS, ANIMAL	E	E	E	E	G	G	G	E		
OILS, PETROLEUM REFINED	G	E	E	E	G	U	E	E	E	
OILS, PETROLEUM SOUR	P	G	E	E	G	U	E	E		
OILS, WATER MIXTURE	E	G	E	E	G		E	E	E	
OILS & FATS			E	G		U		E		
OLAIC ACID			G	U	U		P	E		
OLEIC ACID	G	P	G	G	P	U	E	E	E	
OLEUM	P	G	G	U	U	U	P	E	E	U
OLEUM SPIRITS	U		G	P	U	U	E	E		
OLIVE OIL	P	G	E	E	G	G	E	E	E	
ORTHO-DICHLORO BENZENE	G	G	E	U	U	U	E	E	E	
OTHER KETONES	E	E	E	U	U	U	U	E		
OXALIC ACID	G	U	G	P	G	G	E	E	P	U
OXYGEN	E	G	E	G	G	E	E	E	U	
OZONE, DRY	E	E	E	U	U	E	G	E		
OZONE, WET	G	P	E	U	U	G	G	E		

E-EXCELLENT

G-GOOD

P-POOR

U-UNSATISFACTORY

FLUID	BRASS	CARBON STEEL	316 S.S.	BUNA N (NITRILE)	NEOPRENE	EPR	FLUORO-CARBON	PTFE	ACETAL	NYLON
PAINTS & SOLVENTS	E	E	E	U	U	U	G	E		
PALM OIL	G	P	G	G	G	U	E	E	E	
PALMITIC ACID	G	P	G	G	G	G	E	E	E	
PAPER PULP	G		E	G	G	G	G	E		
PARAFFIN	E	G	E	E	P	U	E	E	E	
PARAFORMALDEHYDE	G	G	G	G	G	U		E	E	
PARALDEHYDE			G	G	G	U		E		
PARA-DICHLOROENZENE	G	E	E	U	U	U			E	
PARKER O LUBE	E	E	E	E	E	U	E			
PEANUT OIL	G	E	E	E	U	U	E			
PENTANE	E	G	E	E	G	U	E	E	E	
PERCHLORETHYLENE, DRY	P	G	E	U	U	U	E	E		
PERCHLORIC ACID-2N	U	U	G	U	G	G			E	
PETROLATUM (PETROLEUM JELLY)	G	P	G	E	G		E	E	E	
PHENOL	G	U	E	U	U	U	G	E	U	E
PHOSPHATE ESTER	U	E	E	U		E		E		
PHOSPHORIC ACID 10%	U	U	U	G	E	G	E	E	U	U
PHOSPHORIC ACID 50% COLD	U	U	U	G	G	G	E	E	U	U
PHOSPHORIC ACID 50% HOT	U	U	U	G	G	G	E	E	U	U
PHOSPHORIC ACID 85% COLD	G	G	E	P	P		G	E	U	U
PHOSPHORIC ACID 85% HOT	P	P	G	P	P			E	U	U
PHOSPHORIC ANHYDRIDE			E	U	U		G	E	G	
PHOSPHOROUS TRICHLORIDE	U	G	E	U	U	G	G	E		
PHTHALIC ACID	G	P	G	P	P		E	E	E	
PHTHALIC ANHYDRIDE	G	P	G	P	P		E	E	E	
PICRIC ACID	P	U	G	P	E	G	G	E		
PINE OIL	G	G	E	E	U	U	E	E	E	
PINEAPPLE JUICE	P	P	E	E	E		E	E	E	
PITCH			E	P	P	U		E		
PLATING SOLUTIONS, CHROME	E	U	E		U	E	E			
PLATING SOLUTIONS, OTHER		E	E	E	U	E	E			
PNEUMATIC SERVICE	E	E	E	E	E	E	E	E		
POLYSULFIDE LIQUOR	U		G	G	G	G	G	E		
POLYVINYL ACETATE	G		G		P	G		E		
POLYVINYL CHLORIDE	G		G		P	G		E		
POTASSIUM ACETATE	G	E	G	G	G	E	U			
POTASSIUM BICARBONATE			E	G				E		E
POTASSIUM BICHROMATE			E	G	G		G	E	G	
POTASSIUM BISULFATE			E	G	G		E	E		
POTASSIUM BISULFITE	P	U	G	E	E	G	E	E	E	
POTASSIUM BROMIDE	P	U	E	E	E	G	E	E	E	P
POTASSIUM CARBONATE	G	G	G	E	E	G	E	E	E	E
POTASSIUM CHLORATE	G	G	G	E	E	G	E	E	E	P
POTASSIUM CHLORIDE	P	P	G	E	E	E	E	E	E	P
POTASSIUM CHROMATE	G		G	G	E	G	G	E		
POTASSIUM CYANIDE	U	G	G	E	E	E	E	E	E	E
POTASSIUM DICHROMATE	U	P	G	E	E	G	E	E	E	U
POTASSIUM DIPHOSPHATE	G	E	E	E			E	E		
POTASSIUM FERRICYANIDE	U	P	E	E	E	G	E	E	E	
POTASSIUM FERROCYANIDE	G	P	G	E	E		E	E	E	
POTASSIUM HYDROXIDEDILUTE COLD	U	E	G	E	G		U	E		E
POTASSIUM HYDROXIDE DILUTE HOT	U	G	G	G	G			E		
POTASSIUM HYDROXIDE TO 70% COLD										
POTASSIUM HYDROXIDE TO 70% HOT	U	E	G	P	G	E			E	
POTASSIUM HYDROXIDE TO 70% HOT	U	E	G	P	G	E		E		
POTASSIUM IODIDE	U	P	G	E	E	G	E	E	E	
POTASSIUM NITRATE	G	G	G	E	E	G	E	E	E	P
POTASSIUM OXALATE			E					E		
POTASSIUM PERMANGANATE	G	G	G	E	E	G	E	E	E	U
POTASSIUM PHOSOHATE	P		G	E	E	E	E	E		
POTASSIUM PHOSPHATE DI-BASIC	G	E	E	E	E	G	E	E	E	
POTASSIUM PHOSPHATE TRI-BASIC		E	G	E	E	G		E		
POTASSIUM SALTS				G	G	E	E			
POTASSIUM SULFATE	G	G	E	E	E	E	E	E	E	P
POTASSIUM SULFIDE	G	G	E	E	G	G	G	E		
POTASSIUM SULFITE	G	G	E	E	G	E	G	E		
PRODUCER GAS	G	G	G	E	G	U	E	E	E	

E-EXCELLENT

G-GOOD

P-POOR

U-UNSATISFACTORY

FLUID	BRASS	CARBON STEEL	316 S.S.	BUNA N (NITRILE)	NEOPRENE	EPR	FLUORO-CARBON	PTFE	ACETAL	NYLON
PROPANE GAS	E	G	G	E	G	U	E	E	E	
PROPYL ACETATE	U	E	E	U	U	G	U			
PROPYL ALCOHOL	E	G	G	E	E		E	E		
PROPYL BROMIDE	G		G	G	G	G	G	E		
PROPYLENE	E	E	E	U	U	U	E			
PROPYLENE GLYCOL	G	G	G	E	E	G	E	E	P	
PYDRAUL	E	P	E	U	U		G	E		
PYRIDINE			G	U	U		U	E		
PYROGARD 42, 43, 53, 55				U	U	E	E			
PYROGARD D				E	G	E	E			
PYROLGALIC ACID	G	G	G	E	E		E	E	E	
QUENCH OIL	G	G	E	E	G		E	E	E	
QUININE, SULFATE, DRY			E					E		
R P-1 FUEL	E	E	E	G	P		E	E	E	
RESINS & ROSINS	E	P	E	P	P		E	E		
RESORCINOL			G					E		
ROAD TAR	E	E	E	G	P	U	E	E	E	
ROOF PITCH	E	E	E	G	P		E	E	E	
ROSIN EMULSION	G	P	E	U	P		G	E		
RUBBER LATEX EMULSIONS	E	G	E				E	E	E	
RUBBER SOLVENTS	E	E	E	U	P		U	E	P	
SALAD OIL	G	P	G	E	E	G	E	E	E	
SALICYLIC ACID	P	U	E	E	E	G	E	E	E	
SALT	G	P	G	E	E		E	E	E	
SALT BRINE	G		G	E	U	G	G	E		
SAUERKRAUT ARINE			G					E		
SEA WATER	P	U	G	E	E	E	E	E	E	
SEWAGE	P	P	G	E	P	G	G	E		
SHELL IRUS 905				E	G	U	E			
SHELLAC	E	E	E	E	E			E		
SILICONE FLUIDS	G		G	G	G		G	E		
SILVER BROMIDE										
SILVER CYANIDE	U		E	G	G		G	E		
SILVER NITRATE	U	U	E	P	P	E	E	E	E	
SILVER PLATING SOL.			E		G			E		
SKYDROL 500	E	G	E	U	U		U	E		
SKYDROL 7000, TYPE 2	U	E	E	U	U	E	G			
SOAP SOLUTIONS	E	E	E	E	G	E	E	E		
SODIUM ACETATE	G	P	G	E	G	G	E	E	E	E
SODIUM ALUMINATE	G	P	E	E	E	G	E	E	E	
SODIUM BENZOATE			G					E		
SODIUM BICARBONATE	G	P	G	E	E	E	E	E	E	E
SODIUM BICHROMATE			G	U				E		
SODIUM BISULFATE 10%	G	U	E	E	E	G	E	E	E	P
SODIUM BISULFITE 10%	G	U	E	E	E	G	E	E	E	P
SODIUM BORATE	G	P	G	E	E	G	E	E	E	
SODIUM BROMIDE 10%	G	P	G	E	E	G	E	E	E	
SODIUM CARBONATE	G	G	E	E	E	G	E	E	E	E
SODIUM CHLORATE	G	P	G	E	E	G	E	E	E	P
SODIUM CHLORIDE	G	P	G	E	E	G	E	E	E	E
SODIUM CHROMATE	P	G	E	E	E	G	E	E	E	
SODIUM CITRATE			G					E		
SODIUM CYANIDE	U	G	E	E	E	G	E	E	E	E
SODIUM FERRICYANIDE			E					E		
SODIUM FLUORIDE	P	U	G	E	E	G	E	E	E	
SODIUM HYDROXIDE 20% COLD	E	E	E	E	E	G	G	E		E
SODIUM HYDROXIDE 20% HOT	E	G	E	G	G	G	P	E		
SODIUM HYDROXIDE 50% COLD	E	E	E	E	E	G	P	E		E
SODIUM HYDROXIDE 50% HOT	E	G	E	E	G	G	P	E		
SODIUM HYDROXIDE 70% COLD	E	E	E	G	P	G	P	E		
SODIUM HYDROXIDE 70% HOT	G	G	E	U	U	G	P	E		
SODIUM HYPOCHLORITE (BLEACH)	U	U	U				E	E		U
SODIUM HYPOSULFITE			G					E		
SODIUM LACTATE			E					E		
SODIUM METAPHOSPHATE	P	G	G	E	E	G		E		
SODIUM METASILICATE COLD	G	P	E	G	E		G	E		
SODIUM METASILICATE HOT	G	U	E					E		

E-EXCELLENT

G-GOOD

P-POOR

U-UNSATISFACTORY

FLUID	BRASS	CARBON STEEL	316 S.S.	BUNA N (NITRILE)	NEOPRENE	EPR	FLUORO-CARBON	PTFE	ACETAL	NYLON
SODIUM NITRATE	G	G	E	P	G	G	E	E	E	E
SODIUM NITRITE			G	P	U	E	G	E	G	
SODIUM PERBORATE	G	G	G	P	G	E	E	E	E	
SODIUM PEROXIDE	U	P	G	P	G	E	E	E	E	
SODIUM PHOSPHATE	P	P	G	G	P	E	E	E	G	
SODIUM PHOSPHATE DI-BASIC	P	P	G	E	E	E	E	E	E	
SODIUM PHOSPHATE TRI-BASIC	P	P	G	G	G	E	E	E	E	
SODIUM POLYPHOSPHATE			G	G	G	E	E	E		
SODIUM SALICYLATE			E				E	E		
SODIUM SALTS										
SODIUM SILICATE	G	G	G	E	E	G	E	E	E	E
SODIUM SILICATE, HOT	P	P	G			G	E	E		
SODIUM SULFATE	G	G	E	E	E	E	E	E		E
SODIUM SULFIDE	U	G	E	E	E	G	E	E	E	E
SODIUM SULFITE	P		G	E	E	G	G	E		
SODIUM TETRABORATE			E	E	E	G		E		
SODIUM THIOSULFATE	P	G	E	E	E	E	E	E	E	
SOYBEAN	G	P	G	E	G	G	E	E	E	
STANNIC CHLORIDE	P	U	U	E	E		E	E		
STARCH	G	P	G	E	E	P	E	E	E	
STEAM (212 F)	E	E	E	U	U	G	P	E	U	
STEARIC ACID	P	P	E	E	P	G	E	E	E	
STODDARD SOLVENT	G	E	G	E	G	U	E			
STYRENE	E	E	E	U	U	U	G	E		
SUCROSE SOLUTIONS	E	E	E	E	G	E	E			
SUGAR, SYRUPS & JAM	G		E		G			E		
SUGAR LIQUIDS	E	G	E	E	E	G	E	E	E	
SULFATE, BLACK LIQUOR	P	P	G	P	G	G	P	E	E	
SULFATE, GREEN LIQUOR	P	P	G	P	G		P	E	E	
SULFATE, WHITE LIQUOR	P	P	G	P	G		P	E	E	
SULFUR	U	P	G	U	P	G	G	E	E	
SULFUR, MOLTEN	U	P	G	U	P	G	G	E		
SULFUR CHLORIDES	G	U	U	U	U	P	E	E	E	
SULFUR DIOXIDE, DRY	G	G	E	U	U	E	E	E	E	
SULFUR DIOXIDE, WET	U		E	U	U	G		E		
SULFUR HEXAFLUORIDE	G		E		G			E		
SULFUR TRIOXIDE	G	G	G	U	U		G	E		
SULFUR TRIOXIDE, DRY	G	G	G	U	U	G	E	E		
SULFURIC ACID 0 TO 77%	P	U	P	G	G		E	E	P	U
SULFURIC ACID 100%	P	P	E	U	U	P	G	E	U	U
SULFUROUS ACID	U	U	G	P	P	P	E	E	P	
SUNSAFE	U	E	E	E	G	U	E			
TALL OIL	G	G	G	G	G	U	E	E		
TANNIC ACID	G	P	G	G	G	G	E	E	E	U
TANNING LIQUORS			G	G	U			E		
TAR & TAR OILS	E	E	E	P	U	U	E	E		
TARTARIC ACID	G	U	E	P	G	G	E	E	E	
TERPINEOL				G	U	U	E			
TERTIARY BUTYL ALCOHOL	E	E	E	G	G	G	E			
TETRACHLOROETHANE		G	E	U	U	U	E			
TETRACHLOROETHYLENE	U	G	U	U	U	E				
TETRAETHYL LEAD	G	P	G					E	E	
TITANIUM TETRACHLORIDE	G	E	G	G	U	U	E			
TOLUOL (TOLUENE)	E	E	E	U	U	U	G	E	E	E
TOMATO JUICE	P	P	E	E	E		E	E		E
TRANSFORMER OIL	G	E	E	E	G		E	E	E	
TRANSMISSION FLUID, TYPE A	E	E	E	E	G	U	E			
TRIBUTYL PHOSPHATE	E	E	E	U	U	G	U	E		
TRICHLOROETHYLENE	G	G	G	U	U	U	G	E	E	U
TRICHLOROACETIC ACID	G		U	P	U		U	E		
TRICHLOROETHANE		G	E	U	U	U	E			
TRICRESYL PHOSPHATE		E	G	U	U	E	G			
TRITHANOLAMINE			G	P	G	G		E		
TRIETHYLAMINE	G		G	G	G			E		
TRISODIUM PHOSPHATE			G	E	E	G	G	E		
TUNG OIL	G	G	E	E	G	U	E	E	E	
TURBINE OIL #15		G	E	G	U	U	E		E	

E-EXCELLENT

G-GOOD

P-POOR

U-UNSATISFACTORY

Parker Safety Guide for Selecting and Using Hose, Tubing, Fittings, Connectors, Conductors, Valves and Related Accessories

Parker Publication No. 4400-B.1

WARNING: Failure or improper selection or improper use of hose, tubing, fittings, assemblies, valves, connectors, conductors or related accessories ("Products") can cause death, personal injury and property damage. Possible consequences of failure or improper selection or improper use of these Products include but are not limited to:

- Fittings thrown off at high speed.
- High velocity fluid discharge.
- Explosion or burning of the conveyed fluid.
- Electrocutation from high voltage electric powerlines.
- Contact with suddenly moving or falling objects that are controlled by the conveyed fluid.
- Injections by high-pressure fluid discharge.
- Dangerously whipping Hose.
- Tube or pipe burst.
- Weld joint fracture.
- Contact with conveyed fluids that may be hot, cold, toxic or otherwise injurious.
- Sparking or explosion caused by static electricity buildup or other sources of electricity.
- Sparking or explosion while spraying paint or flammable liquids.
- Injuries resulting from inhalation, ingestion or exposure to fluids.

Before selecting or using any of these Products, it is important that you read and follow the instructions below. No product from any division in Fluid Connector Group is approved for in-flight aerospace applications. For hoses and fittings used in in-flight aerospace applications, please contact Parker Aerospace Group

GENERAL INSTRUCTIONS

- 1.0 Scope:** This safety guide provides instructions for selecting and using (including assembling, installing, and maintaining) these Products. For convenience, all rubber and/or thermoplastic products commonly called "hose" or "tubing" are called "Hose" in this safety guide. Metallic tube or pipe are called "tube". All assemblies made with Hose are called "Hose Assemblies". All assemblies made with Tube are called "Tube Assemblies". All products commonly called "fittings", "couplings" or "adapters" are called "Fittings". Valves are fluid system components that control the passage of fluid. Related accessories are ancillary devices that enhance or monitor performance including crimping, flaring, flanging, presetting, bending, cutting, deburring, swaging machines, sensors, tags, lockout handles, spring guards and associated tooling. This safety guide is a supplement to and is to be used with the specific Parker publications for the specific Hose, Fittings and Related Accessories that are being considered for use. Parker publications are available at www.parker.com. SAE J1273 (www.sae.org) and ISO 17165-2 (www.ansi.org) also provide recommended practices for hydraulic Hose Assemblies, and should be followed.
- 1.1 Fail-Safe:** Hose, Hose Assemblies, Tube, Tube Assemblies and Fittings can and do fail without warning for many reasons. Design all systems and equipment in a fail-safe mode, so that failure of the Hose, Hose Assembly, Tube, Tube Assembly or Fitting will not endanger persons or property.
- 1.2 Distribution:** Provide a copy of this safety guide to each person responsible for selecting or using Hose, Tube and Fitting products. Do not select or use Parker Hose, Tube or Fittings without thoroughly reading and understanding this safety guide as well as the specific Parker publications for the Products.
- 1.3 User Responsibility:** Due to the wide variety of operating conditions and applications for Hose, Tube and Fittings. Parker does not represent or warrant that any particular Hose, Tube or Fitting is suitable for any specific end use system. This safety guide does not analyze all technical parameters that must be considered in selecting a product. The user, through its own analysis and testing, is solely responsible for:
- Making the final selection of the Products.
 - Assuring that the user's requirements are met and that the application presents no health or safety hazards.
 - Following the safety guide for Related Accessories and being trained to operate Related Accessories.
 - Providing all appropriate health and safety warnings on the equipment on which the Products are used.
 - Assuring compliance with all applicable government and industry standards.
- 1.4 Additional Questions:** Call the appropriate Parker technical service department if you have any questions or require any additional information. See the Parker publication for the Products being considered or used, or call 1-800-CPARKER, or go to www.parker.com, for telephone numbers of the appropriate technical service department.

2.0 HOSE, TUBE AND FITTINGS SELECTION INSTRUCTIONS

- 2.1 Electrical Conductivity:** Certain applications require that the Hose be nonconductive to prevent electrical current flow. Other applications require the Hose and the Fittings and the Hose/Fitting interface to be sufficiently conductive to drain off static electricity. Extreme care must be exercised when selecting Hose, Tube and Fittings for these or any other applications in which electrical conductivity or nonconductivity is a factor.
- The electrical conductivity or nonconductivity of Hose, Tube and Fittings is dependent upon many factors and may be susceptible to change. These factors include but are not limited to the various materials used to make the Hose and the Fittings, Fitting finish (some Fitting finishes are electrically conductive while others are nonconductive), manufacturing methods (including moisture control), how the Fittings contact the Hose, age and amount of deterioration or damage or other changes, moisture content of the Hose at any particular time, and other factors.
- The following are considerations for electrically nonconductive and conductive Hose. For other applications consult the individual catalog pages and the appropriate industry or regulatory standards for proper selection.
- 2.1.1 Electrically Nonconductive Hose:** Certain applications require that the Hose be nonconductive to prevent electrical current flow or to maintain

electrical isolation. For applications that require Hose to be electrically nonconductive, including but not limited to applications near high voltage electric lines, only special nonconductive Hose can be used. The manufacturer of the equipment in which the nonconductive Hose is to be used must be consulted to be certain that the Hose, Tube and Fittings that are selected are proper for the application. Do not use any Parker Hose or Fittings for any such application requiring nonconductive Hose, including but not limited to applications near high voltage electric lines or dense magnetic fields, unless (i) the application is expressly approved in the Parker technical publication for the product, (ii) the Hose is marked "nonconductive", and (iii) the manufacturer of the equipment on which the Hose is to be used specifically approves the particular Parker Hose, Tube and Fittings for such use.

- 2.1.2 Electrically Conductive Hose:** Parker manufactures special Hose for certain applications that require electrically conductive Hose. Parker manufactures special Hose for conveying paint in airless paint spraying applications. This Hose is labeled "Electrically Conductive Airless Paint Spray Hose" on its layline and packaging. This Hose must be properly connected to the appropriate Parker Fittings and properly grounded in order to dissipate dangerous static charge buildup, which occurs in all airless paint spraying applications. Do not use any other Hose for airless paint spraying, even if electrically conductive. Use of any other Hose or failure to properly connect the Hose can cause a fire or an explosion resulting in death, personal injury, and property damage. All hoses that convey fuels must be grounded. Parker manufactures a special Hose for certain compressed natural gas ("CNG") applications where static electricity buildup may occur. Parker CNG Hose assemblies comply with the requirements of ANSI/IAS NGV 4.2; CSA 12.52, "Hoses for Natural Gas Vehicles and Dispensing Systems" (www.ansi.org). This Hose is labeled "Electrically Conductive for CNG Use" on its layline and packaging. This Hose must be properly connected to the appropriate Parker Fittings and properly grounded in order to dissipate dangerous static charge buildup, which occurs in, for example, high velocity CNG dispensing or transfer. Do not use any other Hose for CNG applications where static charge buildup may occur, even if electrically conductive. Use of other Hoses in CNG applications or failure to properly connect or ground this Hose can cause a fire or an explosion resulting in death, personal injury, and property damage. Care must also be taken to protect against CNG permeation through the Hose wall. See section 2.6, Permeation, for more information. Parker CNG Hose is intended for dispenser and vehicle use within the specified temperature range. Parker CNG Hose should not be used in confined spaces or unventilated areas or areas exceeding the specified temperature range. Final assemblies must be tested for leaks. CNG Hose Assemblies should be tested on a monthly basis for conductivity per ANSI/IAS NGV 4.2; CSA 12.52. Parker manufactures special Hose for aerospace in-flight applications. Aerospace in-flight applications employing Hose to transmit fuel, lubricating fluids and hydraulic fluids require a special Hose with a conductive inner tube. This Hose for in-flight applications is available only from Parker's Stratoflex Products Division. Do not use any other Parker Hose for in-flight applications, even if electrically conductive. Use of other Hoses for in-flight applications or failure to properly connect or ground this Hose can cause a fire or an explosion resulting in death, personal injury and property damage. These Hose assemblies for in-flight applications must meet all applicable aerospace industry, aircraft engine and aircraft requirements.
- 2.2 Pressure:** Hose, Tube and Fitting selection must be made so that the published maximum working pressure of the Hose, Tube and Fittings are equal to or greater than the maximum system pressure. The maximum working pressure of a Hose, or Tube Assembly is the lower of the respective published maximum working pressures of the Hose, Tube and the Fittings used. Surge pressures or peak transient pressures in the system must be below the published maximum working pressure for the Hose, Tube and Fitting. Surge pressures and peak pressures can usually only be determined by sensitive electrical instrumentation that measures and indicates pressures at millisecond intervals. Mechanical pressure gauges indicate only average pressures and cannot be used to determine surge pressures or peak transient pressures. Published burst pressure ratings for Hose is for manufacturing test purposes only and is no indication that the Product can be used in applications at the burst pressure or otherwise above the published maximum recommended working pressure.

- 2.3 Suction: Hoses used for suction applications must be selected to insure that the Hose will withstand the vacuum and pressure of the system. Improperly selected Hose may collapse in suction application.
- 2.4 Temperature: Be certain that fluid and ambient temperatures, both steady and transient, do not exceed the limitations of the Hose, Tube, Fitting and Seals. Temperatures below and above the recommended limit can degrade Hose, Tube, Fittings and Seals to a point where a failure may occur and release fluid. Tube and Fittings performances are normally degraded at elevated temperature. Material compatibility can also change at temperatures outside of the rated range. Properly insulate and protect the Hose Assembly when routing near hot objects (e.g. manifolds). Do not use any Hose in any application where failure of the Hose could result in the conveyed fluids (or vapors or mist from the conveyed fluids) contacting any open flame, molten metal, or other potential fire ignition source that could cause burning or explosion of the conveyed fluids or vapors.
- 2.5 Fluid Compatibility: Hose, and Tube Assembly selection must assure compatibility of the Hose tube, cover, reinforcement, Tube, Plating and Seals with the fluid media used. See the fluid compatibility chart in the Parker publication for the product being considered or used. This information is offered only as a guide. Actual service life can only be determined by the end user by testing under all extreme conditions and other analysis. Hose, and Tube that is chemically compatible with a particular fluid must be assembled using Fittings and adapters containing likewise compatible seals. Flange or flare processes can change Tube material properties that may not be compatible with certain requirements such as NACE Permeation: Permeation (that is, seepage through the Hose or Seal) will occur from inside the Hose or Fitting to outside when Hose or Fitting is used with gases, liquid and gas fuels, and refrigerants (including but not limited to such materials as helium, diesel fuel, gasoline, natural gas, or LPG). This permeation may result in high concentrations of vapors which are potentially flammable, explosive, or toxic, and in loss of fluid. Dangerous explosions, fires, and other hazards can result when using the wrong Hose for such applications. The system designer must take into account the fact that this permeation will take place and must not use Hose or Fitting if this permeation could be hazardous. The system designer must take into account all legal, government, insurance, or any other special regulations which govern the use of fuels and refrigerants. Never use a Hose or Fitting even though the fluid compatibility is acceptable without considering the potential hazardous effects that can result from permeation through the Hose or Tube Assembly. Permeation of moisture from outside the Hose or Fitting to inside the Hose or Fitting will also occur in Hose or Tube assemblies, regardless of internal pressure. If this moisture permeation would have detrimental effects (particularly, but not limited to refrigeration and air conditioning systems), incorporation of sufficient drying capacity in the system or other appropriate system safeguards should be selected and used. The sudden pressure release of highly pressurized gas could also result in Explosive Decompression failure of permeated Seals and Hoses.
- 2.7 Size: Transmission of power by means of pressurized fluid varies with pressure and rate of flow. The size of the components must be adequate to keep pressure losses to a minimum and avoid damage due to heat generation or excessive fluid velocity.
- 2.8 Routing: Attention must be given to optimum routing to minimize inherent problems (kinking or flow restriction due to Hose collapse, twisting of the Hose, proximity to hot objects or heat sources). For additional routing recommendations see SAE J1273 and ISO 17165-2. Hose Assemblies have a finite life and should be installed in a manner that allows for ease of inspection and future replacement. Hose because of its relative short life, should not be used in residential and commercial buildings inside of inaccessible walls or floors, unless specifically allowed in the product literature. Always review all product literature for proper installation and routing instructions.
- 2.9 Environment: Care must be taken to insure that the Hose, Tube and Fittings are either compatible with or protected from the environment (that is, surrounding conditions) to which they are exposed. Environmental conditions including but not limited to ultraviolet radiation, sunlight, heat, ozone, moisture, water, salt water, chemicals and air pollutants can cause degradation and premature failure.
- 2.10 Mechanical Loads: External forces can significantly reduce Hose, Tube and Fitting life or cause failure. Mechanical loads which must be considered include excessive flexing, twist, kinking, tensile or side loads, bend radius, and vibration. Use of swivel type Fittings or adapters may be required to insure no twist is put into the Hose. Use of proper Hose or Tube clamps may also be required to reduce external mechanical loads. Unusual applications may require special testing prior to Hose selection.
- 2.11 Physical Damage: Care must be taken to protect Hose from wear, snagging, kinking, bending smaller than minimum bend radius and cutting, any of which can cause premature Hose failure. Any Hose that has been kinked or bent to a radius smaller than the minimum bend radius, and any Hose that has been cut or is cracked or is otherwise damaged should be removed and discarded. Fittings with damages such as scratches on sealing surfaces and deformation should be replaced.
- 2.12 Proper End Fitting: See instructions 3.2 through 3.5. These recommendations may be substantiated by testing to industry standards such as SAE J517 for hydraulic applications, or MIL-A-5070, AS1339, or AS3517 for Hoses from Parker's Stratoflex Products Division for aerospace applications.
- 2.13 Length: When determining the proper Hose or Tube length of an assembly, be aware of Hose length change due to pressure, Tube length change due to thermal expansion or contraction, and Hose or Tube and machine tolerances and movement must be considered. When routing short hose assemblies, it is recommended that the minimum free hose length is always used. Consult the hose manufacturer for their minimum free hose length recommendations. Hose assemblies should be installed in such a way that any motion or flexing occurs within the same plane.
- 2.14 Specifications and Standards: When selecting Hose, Tube and Fittings, government, industry, and Parker specifications and recommendations must be reviewed and followed as applicable.
- 2.15 Hose Cleanliness: Hose and Tube components may vary in cleanliness levels. Care must be taken to insure that the Hose and Tube Assembly selected has an adequate level of cleanliness for the application.
- 2.16 Fire Resistant Fluids: Some fire resistant fluids that are to be conveyed by Hose or Tube require use of the same type of Hose or Tube as used with petroleum base fluids. Some such fluids require a special Hose, Tube, Fitting and Seal, while a few fluids will not work with any Hose at all. See instructions 2.5 and 1.5. The wrong Hose, Tube, Fitting or Seal may fail after a very short service. In addition, all liquids but pure water may burn fiercely under certain conditions, and even pure water leakage may be hazardous.
- 2.17 Radiant Heat: Hose and Seals can be heated to destruction without contact by such nearby items as hot manifolds or molten metal. The same heat source may then initiate a fire. This can occur despite the presence of cool air around the Hose or Seal. Performance of Tube and Fitting subjected to the heat could be degraded.
- 2.18 Welding or Brazing: When using a torch or arc welder in close proximity to hydraulic lines, the hydraulic lines should be removed or shielded with appropriate fire resistant materials. Flame or weld spatter could burn through the Hose or Seal and possibly ignite escaping fluid resulting in a catastrophic failure. Heating of plated parts, including Hose Fittings and adapters, above 450°F (232°C) such as during welding, brazing or soldering may emit deadly gases. Any elastomer seal on fittings shall be removed prior to welding or brazing, any metallic surfaces shall be protected after brazing or welding when necessary. Welding and brazing filler material shall be compatible with the Tube and Fitting that are joined.
- 2.19 Atomic Radiation: Atomic radiation affects all materials used in Hose and Tube assemblies. Since the long-term effects may be unknown, do not expose Hose or Tube assemblies to atomic radiation. Nuclear applications may require special Tube and Fittings.
- 2.20 Aerospace Applications: The only Hose, Tube and Fittings that may be used for in-flight aerospace applications are those available from Parker's Stratoflex Products Division. Do not use any other Hose or Fittings for in-flight applications. Do not use any Hose or Fittings from Parker's Stratoflex Products Division with any other Hose or Fittings, unless expressly approved in writing by the engineering manager or chief engineer of Stratoflex Products Division and verified by the user's own testing and inspection to aerospace industry standards.
- 2.21 Unlocking Couplings: Ball locking couplings or other Fittings with quick disconnect ability can unintentionally disconnect if they are dragged over obstructions, or if the sleeve or other disconnect member, is bumped or moved enough to cause disconnect. Threaded Fittings should be considered where there is a potential for accidental uncoupling.
- 3.0 HOSE AND FITTINGS ASSEMBLY AND INSTALLATION INSTRUCTIONS**
- 3.1 Component Inspection: Prior to assembly, a careful examination of the Hose and Fittings must be performed. All components must be checked for correct style, size, catalog number, and length. The Hose must be examined for cleanliness, obstructions, blisters, cover looseness, kinks, cracks, cuts or any other visible defects. Inspect the Fitting and sealing surfaces for burrs, nicks, corrosion or other imperfections. Do NOT use any component that displays any signs of nonconformance.
- 3.2 Hose and Fitting Assembly: Do not assemble a Parker Fitting on a Parker Hose that is not specifically listed by Parker for that Fitting, unless authorized in writing by the engineering manager or chief engineer of the appropriate Parker division. Do not assemble a Parker Fitting on another manufacturer's Hose or a Parker Hose on another manufacturer's Fitting unless (i) the engineering manager or chief engineer of the appropriate Parker division approves the Assembly in writing or that combination is expressly approved in the appropriate Parker literature for the specific Parker product, and (ii) the user verifies the Assembly and the application through analysis and testing. For Parker Hose that does not specify a Parker Fitting, the user is solely responsible for the selection of the proper Fitting and Hose Assembly procedures. See instruction 1.4. To prevent the possibility of problems such as leakage at the Fitting or system contamination, it is important to completely remove all debris from the cutting operation before installation of the Fittings. The Parker published instructions must be followed for assembling the Fittings on the Hose. These instructions are provided in the Parker Fitting catalog for the specific Parker Fitting being used, or by calling 1-800-CPARKER, or at www.parker.com.
- 3.3 Related Accessories: Do not crimp or swage any Parker Hose or Fitting with anything but the listed swage or crimp machine and dies in accordance with Parker published instructions. Do not crimp or swage another manufacturer's Fitting with a Parker crimp or swage die unless authorized in writing by the engineering manager or chief engineer of the appropriate Parker division.
- 3.4 Parts: Do not use any Parker Fitting part (including but not limited to socket, shell, nipple, or insert) except with the correct Parker mating parts, in accordance with Parker published instructions, unless authorized in writing by the engineering manager or chief engineer of the appropriate Parker division.
- 3.5 Field Attachable/Permanent: Do not reuse any field attachable Hose Fitting that has blown or pulled off a Hose. Do not reuse a Parker permanent Hose Fitting (crimped or swaged) or any part thereof. Complete Hose Assemblies may only be reused after proper inspection under section 4.0. Do not assemble Fittings to any previously used hydraulic Hose that was in service, for use in a fluid power application.
- 3.6 Pre-Installation Inspection: Prior to installation, a careful examination of the Hose Assembly must be performed. Inspect the Hose Assembly for any damage or defects. DO NOT use any Hose Assembly that displays any signs of nonconformance.
- 3.7 Minimum Bend Radius: Installation of a Hose at less than the minimum listed bend radius may significantly reduce the Hose life. Particular attention must be given to preclude sharp bending at the Hose to Fitting juncture. Any bending during installation at less than the minimum bend radius must be avoided. If any Hose is kinked during installation, the Hose must be discarded.
- 3.8 Twist Angle and Orientation: Hose Assembly installation must be such that relative motion of machine components does not produce twisting.
- 3.9 Securement: In many applications, it may be necessary to restrain, protect, or guide the Hose to protect it from damage by unnecessary flexing, pressure surges, and contact with other mechanical components. Care must be taken to insure such restraints do not introduce additional stress or wear points.
- 3.10 Proper Connection of Ports: Proper physical installation of the Hose Assembly

requires a correctly installed port connection insuring that no twist or torque is transferred to the Hose when the Fittings are being tightened or otherwise during use.

- 3.11 **External Damage:** Proper installation is not complete without insuring that tensile loads, side loads, kinking, flattening, potential abrasion, thread damage or damage to sealing surfaces are corrected or eliminated. See instruction 2.10.
- 3.12 **System Checkout:** All air entrapment must be eliminated and the system pressurized to the maximum system pressure (at or below the Hose maximum working pressure) and checked for proper function and freedom from leaks. Personnel must stay out of potential hazardous areas while testing and using.
- 3.13 **Routing:** The Hose Assembly should be routed in such a manner so if a failure does occur, the escaping media will not cause personal injury or property damage. In addition, if fluid media comes in contact with hot surfaces, open flame or sparks, a fire or explosion may occur. See section 2.4.
- 3.14 **Ground Fault Equipment Protection Devices (GFEPDs):** **WARNING!** Fire and Shock Hazard. To minimize the danger of fire if the heating cable of a Multitube bundle is damaged or improperly installed, use a Ground Fault Equipment Protection Device. Electrical fault currents may be insufficient to trip a conventional circuit breaker. For ground fault protection, the IEEE 515: (www.ansi.org) standard for heating cables recommends the use of GFEPDs with a nominal 30 milliampere trip level for "piping systems in classified areas, those areas requiring a high degree of maintenance, or which may be exposed to physical abuse or corrosive atmospheres".

4.0 TUBE AND FITTINGS ASSEMBLY AND INSTALLATION INSTRUCTIONS

- 4.1 **Component Inspection:** Prior to assembly, a careful examination of the Tube and Fittings must be performed. All components must be checked for correct style, size, material, seal, and length. Inspect the Fitting and sealing surfaces for burrs, nicks, corrosion, missing seal or other imperfections. Do NOT use any component that displays any signs of nonconformance.
- 4.2 **Tube and Fitting Assembly:** Do not assemble a Parker Fitting with a Tube that is not specifically listed by Parker for that Fitting, unless authorized in writing by the engineering manager or chief engineer of the appropriate Parker division. The Tube must meet the requirements specified to the Fitting. The Parker published instructions must be followed for assembling the Fittings to a Tube. These instructions are provided in the Parker Fitting catalog for the specific Parker Fitting being used, or by calling 1-800-CPARKER, or at www.parker.com.
- 4.3 **Related Accessories:** Do not preset or flange Parker Fitting components using another manufacturer's equipment or procedures unless authorized in writing by the engineering manager or chief engineer of the appropriate Parker division. Tube, Fitting component and tooling must be checked for correct style, size and material. Operation and maintenance of Related Accessories must be in accordance with the operation manual for the designated Accessory.
- 4.4 **Securement:** In many applications, it may be necessary to restrain, protect, or guide the Tube to protect it from damage by unnecessary flexing, pressure surges, vibration, and contact with other mechanical components. Care must be taken to insure such restraints do not introduce additional stress or wear points.
- 4.5 **Proper Connection of Ports:** Proper physical installation of the Tube Assembly requires a correctly installed port connection insuring that no torque is transferred to the Tube when the Fittings are being tightened or otherwise during use.
- 4.6 **External Damage:** Proper installation is not complete without insuring that tensile loads, side loads, flattening, potential abrasion, thread damage or damage to sealing surfaces are corrected or eliminated. See instruction 2.10.
- 4.7 **System Checkout:** All air entrapment must be eliminated and the system pressurized to the maximum system pressure (at or below the Tube Assembly maximum working pressure) and checked for proper function and freedom from leaks. Personnel must stay out of potential hazardous areas while testing and using.
- 4.8 **Routing:** The Tube Assembly should be routed in such a manner so if a failure does occur, the escaping media will not cause personal injury or property damage. In addition, if fluid media comes in contact with hot surfaces, open flame or sparks, a fire or explosion may occur. See section 2.4.

5.0 HOSE AND FITTING MAINTENANCE AND REPLACEMENT INSTRUCTIONS

- 5.1 Even with proper selection and installation, Hose life may be significantly reduced without a continuing maintenance program. The severity of the application, risk potential from a possible Hose failure, and experience with any Hose failures in the application or in similar applications should determine the frequency of the inspection and the replacement for the Products so that Products are replaced before any failure occurs. Certain products require maintenance and inspection per industry requirements. Failure to adhere to these requirements may lead to premature failure. A maintenance program must be established and followed by the user and, at minimum, must include instructions 5.2 through 5.7
- 5.2 **Visual Inspection Hose/Fitting:** Any of the following conditions require immediate shut down and replacement of the Hose Assembly:
- Fitting slippage on Hose;
 - Damaged, cracked, cut or abraded cover (any reinforcement exposed);
 - Hard, stiff, heat cracked, or charred Hose;
 - Cracked, damaged, or badly corroded Fittings;
 - Leaks at Fitting or in Hose;
 - Kinked, crushed, flattened or twisted Hose; and
 - Blistered, soft, degraded, or loose cover.
- 5.3 **Visual Inspection All Other:** The following items must be tightened, repaired, corrected or replaced as required:
- Leaking port conditions;
 - Excess dirt buildup;
 - Worn clamps, guards or shields; and
 - System fluid level, fluid type, and any air entrapment.
- 5.4 **Functional Test:** Operate the system at maximum operating pressure and check for possible malfunctions and leaks. Personnel must avoid potential hazardous areas while testing and using the system. See section 2.2.
- 5.5 **Replacement Intervals:** Hose assemblies and elastomeric seals used on Hose Fittings and adapters will eventually age, harden, wear and deteriorate under thermal cycling and compression set. Hose Assemblies and elastomeric seals

should be inspected and replaced at specific replacement intervals, based on previous service life, government or industry recommendations, or when failures could result in unacceptable downtime, damage, or injury risk. See section 1.2. Hose and Fittings may be subjected to internal mechanical and/or chemical wear from the conveying fluid and may fail without warning. The user must determine the product life under such circumstances by testing. Also see section 2.5.

- 5.6 **Hose Inspection and Failure:** Hydraulic power is accomplished by utilizing high pressure fluids to transfer energy and do work. Hoses, Fittings and Hose Assemblies all contribute to this by transmitting fluids at high pressures. Fluids under pressure can be dangerous and potentially lethal and, therefore, extreme caution must be exercised when working with fluids under pressure and handling the Hoses transporting the fluids. From time to time, Hose Assemblies will fail if they are not replaced at proper time intervals. Usually these failures are the result of some form of misapplication, abuse, wear or failure to perform proper maintenance. When Hoses fail, generally the high pressure fluids inside escape in a stream which may or may not be visible to the user. Under no circumstances should the user attempt to locate the leak by "feeling" with their hands or any other part of their body. High pressure fluids can and will penetrate the skin and cause severe tissue damage and possibly loss of limb. Even seemingly minor hydraulic fluid injection injuries must be treated immediately by a physician with knowledge of the tissue damaging properties of hydraulic fluid. If a Hose failure occurs, immediately shut down the equipment and leave the area until pressure has been completely released from the Hose Assembly. Simply shutting down the hydraulic pump may or may not eliminate the pressure in the Hose Assembly. Many times check valves, etc., are employed in a system and can cause pressure to remain in a Hose Assembly even when pumps or equipment are not operating. Tiny holes in the Hose, commonly known as pinholes, can eject small, dangerously powerful but hard to see streams of hydraulic fluid. It may take several minutes or even hours for the pressure to be relieved so that the Hose Assembly may be examined safely. Once the pressure has been reduced to zero, the Hose Assembly may be taken off the equipment and examined. It must always be replaced if a failure has occurred. Never attempt to patch or repair a Hose Assembly that has failed. Consult the nearest Parker distributor or the appropriate Parker division for Hose Assembly replacement information. Never touch or examine a failed Hose Assembly unless it is obvious that the Hose no longer contains fluid under pressure. The high pressure fluid is extremely dangerous and can cause serious and potentially fatal injury.
- 5.7 **Elastomeric seals:** Elastomeric seals will eventually age, harden, wear and deteriorate under thermal cycling and compression set. Elastomeric seals should be inspected and replaced.
- 5.8 **Refrigerant gases:** Special care should be taken when working with refrigeration systems. Sudden escape of refrigerant gases can cause blindness if the escaping gases contact the eye and can cause freezing or other severe injuries if it contacts any other portion of the body.
- 5.9 **Compressed natural gas (CNG):** Parker CNG Hose Assemblies should be tested after installation and before use, and at least on a monthly basis per instructions provided on the Hose Assembly tag. The recommended procedure is to pressurize the Hose and check for leaks and to visually inspect the Hose for damage and to perform an electrical resistance test. Caution: Matches, candles, open flame or other sources of ignition shall not be used for Hose inspection. Leak check solutions should be rinsed off after use.
- #### 6.0 HOSE STORAGE
- 6.1 **Age Control:** Hose and Hose Assemblies must be stored in a manner that facilitates age control and first-in and first-out usage based on manufacturing date of the Hose and Hose Assemblies. Unless otherwise specified by the manufacturer or defined by local laws and regulations:
- 6.1.1 The shelf life of rubber hose in bulk form or hose made from two or more materials is 28 quarters (7 years) from the date of manufacture, with an extension of 12 quarters (3 years), if stored in accordance with ISO 22303;
- 6.1.2 The shelf life of thermoplastic and polytetrafluoroethylene hose is considered to be unlimited;
- 6.1.3 Hose assemblies that pass visual inspection and proof test shall not be stored for longer than 2 years.
- 6.1.4 **Storage:** Stored Hose and Hose Assemblies must not be subjected to damage that could reduce their expected service life and must be placed in a cool, dark and dry area with the ends capped. Stored Hose and Hose Assemblies must not be exposed to temperature extremes, ozone, oils, corrosive liquids or fumes, solvents, high humidity, rodents, insects, ultraviolet light, electromagnetic fields or radioactive materials.

PARKER-HANNIFIN CORPORATION OFFER OF SALE

1. **Definitions.** As used herein, the following terms have the meanings indicated.

- Buyer: means any customer receiving a Quote for Products.
- Goods: means any tangible part, system or component to be supplied by Seller.
- Products: means the Goods, Services and/or Software as described in a Quote.
- Quote: means the offer or proposal made by Seller to Buyer for the supply of Products.
- Seller: means Parker-Hannifin Corporation, including all divisions and businesses thereof.
- Services: means any services to be provided by Seller.
- Software: means any software related to the Goods, whether embedded or separately downloaded.
- Terms: means the terms and conditions of this Offer of Sale.

2. **Terms.** All sales of Products by Seller are expressly conditioned upon, and will be governed by the acceptance of, these Terms. These Terms are incorporated into any Quote provided by Seller to Buyer. Buyer's order for any Products whether communicated to Seller verbally, in writing, by electronic data interface or other electronic commerce, shall constitute acceptance of these Terms. Seller objects to any contrary or additional terms or conditions of Buyer. Reference in Seller's order acknowledgement to Buyer's purchase order or purchase order number shall in no way constitute an acceptance of any of Buyer's terms or conditions of purchase. No modification to these Terms will be binding on Seller unless agreed to in writing and signed by an authorized representative of Seller.

3. **Price; Payment.** The Products set forth in the Quote are offered for sale at the prices indicated in the Quote. Unless otherwise specifically stated in the Quote, prices are valid for thirty (30) days and do not include any sales, use, or other taxes or duties. Seller reserves the right to modify prices at any time to adjust for any raw material price fluctuations. Unless otherwise specified by Seller, all prices are F.C.A. Seller's facility (INCOTERMS 2020). All sales are contingent upon credit approval and full payment for all purchases is due thirty (30) days from the date of invoice (or such date as may be specified in the Quote). Unpaid invoices beyond the specified payment date incur interest at the rate of 1.5% per month or the maximum allowable rate under applicable law.

4. **Shipment; Delivery; Title and Risk of Loss.** All delivery dates are approximate, and Seller is not responsible for damages resulting from any delay. Regardless of the manner of shipment, delivery occurs and title and risk of loss or damage pass to Buyer, upon placement of the Products with the carrier at Seller's facility. Unless otherwise agreed prior to shipment and for domestic delivery locations only, Seller will select and arrange, at Buyer's sole expense, the carrier and means of delivery. When Seller selects and arranges the carrier and means of delivery, freight and insurance costs for shipment to the designated delivery location will be prepaid by Seller and added as a separate line item to the invoice. Buyer shall be responsible for any additional shipping charges incurred by Seller due to Buyer's acts or omissions. Buyer shall not return or repackage any Products without the prior written authorization from Seller, and any return shall be at the sole cost and expense of Buyer.

5. **Warranty.** The warranty for the Products is as follows: (i) Goods are warranted against defects in material or workmanship for a period of twelve (12) months from the date of delivery or 2,000 hours of use, whichever occurs first; (ii) Services shall be performed in accordance with generally accepted practices and using the degree of care and skill that is ordinarily exercised and customary in the field to which the Services pertain and are warranted for a period of six (6) months from the date of completion of the Services; and (iii) Software is only warranted to perform in accordance with applicable specifications provided by Seller to Buyer for ninety (90) days from the date of delivery or, when downloaded by a Buyer or end-user, from the date of the initial download. All prices are based upon the exclusive limited warranty stated above, and upon the following disclaimer: **EXEMPTION CLAUSE; DISCLAIMER OF WARRANTY, CONDITIONS, REPRESENTATIONS; THIS WARRANTY IS THE SOLE AND ENTIRE WARRANTY, CONDITION, AND REPRESENTATION, PERTAINING TO PRODUCTS. SELLER DISCLAIMS ALL OTHER WARRANTIES, CONDITIONS, AND REPRESENTATIONS, WHETHER STATUTORY, EXPRESS OR IMPLIED, INCLUDING BUT NOT LIMITED TO THOSE RELATING TO DESIGN, NONINFRINGEMENT, MERCHANTABILITY, AND FITNESS FOR A PARTICULAR PURPOSE. SELLER DOES NOT WARRANT THAT THE SOFTWARE IS ERROR-FREE OR FAULT-TOLERANT, OR THAT BUYER'S USE THEREOF WILL BE SECURE OR UNINTERRUPTED. UNLESS OTHERWISE AUTHORIZED IN WRITING BY SELLER, THE SOFTWARE SHALL NOT BE USED IN CONNECTION WITH HAZARDOUS OR HIGH RISK ACTIVITIES OR ENVIRONMENTS. EXCEPT AS EXPRESSLY STATED HEREIN, ALL PRODUCTS ARE PROVIDED "AS IS".**

6. **Claims; Commencement of Actions.** Buyer shall promptly inspect all Products upon receipt. No claims for shortages will be allowed unless reported to Seller within ten (10) days of delivery. Buyer shall notify Seller of any alleged breach of warranty within thirty (30) days after the date the non-conformance is or should have been discovered by Buyer. Any claim or action against Seller based upon breach of contract or any other theory, including tort, negligence, or otherwise must be commenced within twelve (12) months from the date of the alleged breach or other alleged event, without regard to the date of discovery.

7. **LIMITATION OF LIABILITY.** IN THE EVENT OF A BREACH OF WARRANTY, SELLER WILL, AT ITS OPTION, REPAIR OR REPLACE THE NON-CONFORMING PRODUCT, RE-PERFORM THE SERVICES, OR REFUND THE PURCHASE PRICE PAID WITHIN A REASONABLE PERIOD OF TIME. **IN NO EVENT IS SELLER LIABLE FOR ANY SPECIAL, INDIRECT, INCIDENTAL OR CONSEQUENTIAL DAMAGES INCLUDING ANY LOSS OF REVENUE OR PROFITS, WHETHER BASED IN CONTRACT, TORT OR OTHER LEGAL THEORY. IN NO EVENT SHALL SELLER'S LIABILITY UNDER ANY CLAIM MADE BY BUYER EXCEED THE PURCHASE PRICE PAID FOR THE PRODUCTS.**

8. **Confidential Information.** Buyer acknowledges and agrees that any technical, commercial, or other confidential information of Seller, including, without limitation, pricing, technical drawings or prints and/or part lists, which has been or will be disclosed, delivered or made available, whether directly or indirectly, to Buyer ("Confidential Information"), has been and will be received in confidence and will remain the property of Seller. Buyer further agrees that it will not use Seller's Confidential Information for any purpose other than for the benefit of Seller.

9. **Loss to Buyer's Property.** Any tools, patterns, materials, equipment or information furnished by Buyer or which are or become Buyer's property ("Buyer's Property"), will be considered obsolete and may be destroyed by Seller after two (2) consecutive years have elapsed without Buyer ordering the Products manufactured using Buyer's Property. Furthermore, Seller shall not be responsible for any loss or damage to Buyer's Property while it is in Seller's possession or control.

10. **Special Tooling.** "Special Tooling" includes but is not limited to tools, jigs, fixtures and associated manufacturing equipment acquired or necessary to manufacture Goods. Seller may impose a tooling charge for any Special Tooling. Such Special Tooling shall be and remain Seller's property notwithstanding payment of any charges by Buyer. In no event will Buyer acquire any interest in the Special Tooling, even if such Special Tooling has been specially converted or adapted for manufacture of Goods for Buyer and notwithstanding any charges paid by Buyer. Unless otherwise agreed, Seller has the right to alter, discard or otherwise dispose of any Special Tooling or other property owned by Seller in its sole discretion at any time.

11. **Security Interest.** To secure payment of all sums due from Buyer, Seller retains a security interest in all Products delivered to Buyer and, Buyer's acceptance of these Terms is deemed to be a Security Agreement under the Uniform Commercial Code. Buyer authorizes Seller as its attorney to execute and file on Buyer's behalf all documents Seller deems necessary to perfect Seller's security interest.

12. **User Responsibility.** Buyer, through its own analysis and testing, is solely responsible for making the final selection of the Products and assuring that all performance, endurance, maintenance, safety and warning requirements of the application of the Products are met. Buyer must analyze all aspects of the application and follow applicable industry standards, specifications, and any technical information provided with the Quote or the Products, such as Seller's instructions, guides and specifications. If Seller provides options of or for Products based upon data or specifications provided by Buyer, Buyer is responsible for determining that such data and specifications are suitable and sufficient for all applications and reasonably foreseeable uses of the Products. In the event Buyer is not the end-user of the Products, Buyer will ensure such end-user complies with this paragraph.

13. **Use of Products, Indemnity by Buyer.** Buyer shall comply with all instructions, guides and specifications provided by Seller with the Quote or the Products. **Unauthorized Uses.** If Buyer uses or resells the Products in any way prohibited by Seller's instructions, guides or specifications, or Buyer otherwise fails to comply with Seller's instructions, guides and specifications, Buyer acknowledges that any such use, resale, or non-compliance is at Buyer's sole risk. Further, Buyer shall indemnify, defend, and hold Seller harmless from any losses, claims, liabilities, damages, lawsuits, judgments and costs (including attorney fees and defense costs), whether for personal injury, property damage, intellectual property infringement or any other claim, arising out of or in connection with: (a) improper selection, design, specification, application, or any misuse of Products; (b) any act or omission, negligent or otherwise, of Buyer; (c) Seller's use of patterns, tools, equipment, plans, drawings, designs, specifications or other information or things furnished by Buyer; (d) damage to the Products from an external cause, repair or attempted repair by anyone other than Seller, failure to follow instructions, guides and specifications provided by Seller, use with goods not provided by Seller, or opening, modifying, deconstructing, tampering with or repackaging the Products; or (e) Buyer's failure to comply with these Terms. Seller shall not indemnify Buyer under any circumstance except as otherwise provided in these Terms.

14. **Cancellations and Changes.** Buyer may not cancel or modify, including but not limited to movement of delivery dates for the Products, any order for any reason except with Seller's written consent and upon terms that will indemnify, defend and hold Seller harmless against all direct, incidental and consequential loss or damage and any additional expense. Seller, at any time, may change features, specifications, designs and availability of Products.

15. **Limitation on Assignment.** Buyer may not assign its rights or obligations without the prior written consent of Seller.

16. **Force Majeure.** Seller is not liable for delay or failure to perform any of its obligations by reason of events or circumstances beyond its reasonable control. Such circumstances include without limitation: accidents, labor disputes or stoppages, government acts or orders, acts of nature, pandemics, epidemics, other widespread illness, or public health emergency, delays or failures in delivery from carriers or suppliers, shortages of materials, war (whether declared or not) or the serious threat of same, riots, rebellions, acts of terrorism, fire or any reason whether similar to the foregoing or otherwise. Seller will resume performance as soon as practicable after the event of force majeure has been removed. All delivery dates affected by force majeure shall be tolled for the duration of such force majeure and rescheduled for mutually agreed dates as soon as practicable after the force majeure condition ceases to exist. Force majeure shall not include financial distress, insolvency, bankruptcy, or other similar conditions affecting one of the parties, affiliates and/or sub-contractors.

17. **Waiver and Severability.** Failure to enforce any provision of these Terms will not invalidate that provision; nor will any such failure prejudice either party's right to enforce that provision in the future. Invalidation of any provision of these Terms shall not invalidate any other provision herein and, the remaining provisions will remain in full force and effect.

18. **Termination.** Seller may terminate any agreement governed by or arising from these Terms for any reason and at any time by giving Buyer thirty (30) days prior written notice. Seller may immediately terminate, in writing, if Buyer: (a) breaches any provision of these Terms, (b) becomes or is deemed insolvent, (c) appoints or has appointed a trustee, receiver or custodian for all or any part of Buyer's property, (d) files a petition for relief in bankruptcy on its own behalf, or one is filed against Buyer by a third party, (e) makes an assignment for the benefit of creditors; or (f) dissolves its business or liquidates all or a majority of its assets.

19. **Ownership of Software.** Seller retains ownership of all Software supplied to Buyer hereunder. In no event shall Buyer obtain any greater right in and to the Software than a right in the nature of a license limited to the use thereof and subject to compliance with any other terms provided with the Software.

20. **Indemnity for Infringement of Intellectual Property Rights.** Seller is not liable for infringement of any patents, trademarks, copyrights, trade dress, trade secrets or similar rights ("Intellectual Property Rights") except as provided in this Section. Seller will defend at its expense and will pay the cost of any settlement or damages awarded in an action brought against Buyer based on a third party claim that one or more of the Products sold hereunder infringes the Intellectual Property Rights of a third party in the country of delivery of the Products by Seller to Buyer. Seller's obligation to defend and indemnify Buyer is contingent on Buyer notifying Seller within ten (10) days after Buyer becomes aware of any such claim, and Seller having sole control over the defense of the claim including all negotiations for settlement or compromise. If one or more Products sold hereunder is subject to such a claim, Seller may, at its sole expense and option, procure for Buyer the right to continue using the Products, replace or modify the Products so as to render them non-infringing, or offer to accept return of the Products and refund the purchase price less

a reasonable allowance for depreciation. Seller has no obligation or liability for any claim of infringement: (i) arising from information provided by Buyer; or (ii) directed to any Products provided hereunder for which the designs are specified in whole or part by Buyer; or (iii) resulting from the modification, combination or use in a system of any Products provided hereunder. The foregoing provisions of this Section constitute Seller's sole and exclusive liability and Buyer's sole and exclusive remedy for claims of infringement of Intellectual Property Rights.

21. **Governing Law.** These Terms and the sale and delivery of all Products are deemed to have taken place in, and shall be governed and construed in accordance with, the laws of the State of Ohio, as applicable to contracts executed and wholly performed therein and without regard to conflicts of laws principles. Buyer irrevocably agrees and consents to the exclusive jurisdiction and venue of the courts of Cuyahoga County, Ohio with respect to any dispute, controversy or claim arising out of or relating to the sale and delivery of the Products.

22. **Entire Agreement.** These Terms, along with the terms set forth in the main body of any Quote, forms the entire agreement between the Buyer and Seller and constitutes the final, complete and exclusive expression of the terms of sale and purchase. In the event of a conflict between any term set forth in the main body of a Quote and these Terms, the terms set forth in the main body of the Quote shall prevail. All prior or contemporaneous written or oral agreements or negotiations with respect to the subject matter shall have no effect. These Terms may not be modified unless in writing and signed by an authorized representative of Seller.

23. **Compliance with Laws.** Buyer agrees to comply with all applicable laws, regulations, and industry and professional standards, including those of the United States of America, and the country or countries in which Buyer may operate, including without limitation the U.S. Foreign Corrupt Practices Act ("FCPA"), the U.S. Anti-Kickback Act ("Anti-Kickback Act"), U.S. and E.U. export control and sanctions laws ("Export Laws"), the U.S. Food Drug and Cosmetic Act ("FDCA"), and the rules and regulations promulgated by the U.S. Food and Drug Administration ("FDA"), each as currently amended. Buyer agrees to indemnify, defend, and hold harmless Seller from the consequences of any violation of such laws, regulations and standards by Buyer, its employees or agents. Buyer acknowledges that it is familiar with all applicable provisions of the FCPA, the Anti-Kickback Act, Export Laws, the FDCA and the FDA and certifies that Buyer will adhere to the requirements thereof and not take any action that would make Seller violate such requirements. Buyer represents and agrees that Buyer will not make any payment or give anything of value, directly or indirectly, to any governmental official, foreign political party or official thereof, candidate for foreign political office, or commercial entity or person, for any improper purpose, including the purpose of influencing such person to purchase Products or otherwise benefit the business of Seller. Buyer further represents and agrees that it will not receive, use, service, transfer or ship any Products from Seller in a manner or for a purpose that violates Export Laws or would cause Seller to be in violation of Export Laws. Buyer agrees to promptly and reliably provide Seller all requested information or documents, including end-user statements and other written assurances, concerning Buyer's ongoing compliance with Export Laws.

4CB-SR.....	I13	62PTBH.....	D30	0117.....	F19
9-DC.....	I14	63PT.....	D9, D13	0118.....	D22, D23
9L04.....	G11, G14	66C.....	D9	0119.....	D22, D23
9L05.....	G11, G14	66CA.....	D14	0121.....	F19
9L85.....	G11, G15	66P.....	D30	122HBL.....	E10
16-CB.....	I13	66PLP.....	A8	0123.....	E13
18-DC.....	I14	66PLPBH.....	A8	0124.....	D25
20.....	E6	68C.....	D9	0125.....	D27
22.....	E6	68CA.....	D14	125HB.....	E10
22BH.....	E6	68HB.....	E10	125HBL.....	E10
22CA.....	E6	68HB-X-MI.....	F26	125HBLSV.....	E11
22CABH.....	E6	68HB-X-MIX.....	E10	126HBL.....	E11
24B-Cabinet.....	I14	68NTA-X-MI.....	F26	0127.....	D27, I10
24-CB.....	I13	68P.....	D31	127HB.....	E11
26.....	E6	68PLPR.....	A9	128HBLSV.....	E11
27.....	E6	68PLP-X-0.....	A9	129HB.....	E11
28.....	E6, E7	69GH.....	F28	0136.....	E14
30GH.....	B43	70GH.....	F28	0138.....	I9
31GH.....	B43	71GH.....	F28	0139.....	I9
31HB.....	B43	75GH.....	F28	139HB.....	E12
40B-Cabinet.....	I15	78GH.....	F28	0142.....	D24
40B-STAND.....	I14	79GH.....	F28	0143.....	F18
48F-X-MI.....	F26	80GH.....	F28	0144.....	F18
50GHSV.....	F28	81GH.....	F28	0145.....	F18
53GH.....	F28	82GH.....	F28	146HBLFVSV.....	E12
54GH.....	F28	83GH.....	F28	149F-X-MI.....	F26
55GH.....	F28	88GH.....	F28	0152.....	F18
56PSG.....	D29	90GH.....	F28	0155.....	F20
59CA.....	D13	94GH.....	F28	0158.....	F19
59P.....	D29	95GH.....	F29	159F-X-MI.....	F26
60C.....	D8	96GH.....	F29	0163.....	F20
60P.....	D29	97HC.....	E10	0164.....	F18
60PB.....	D29	97P.....	D31	164C.....	D10
60PT.....	D8	98GH.....	F29	164CA.....	D14
61C.....	D8	98GHSV.....	F29	164P.....	D33
61CA.....	D13	99GH.....	F29	164PLP.....	A9
61CL.....	D8	99GHSV.....	F29	165C.....	D10
61P.....	D29	0101.....	D18, D19	165CA.....	D14
61PB.....	D29	101GHSV.....	F29	165PLP.....	A10
61PN.....	D29	0102.....	D24	0168.....	D27, F20
61PSGN.....	D29	0103.....	D22	0169.....	F20
62C.....	D8	0104.....	D24	169C.....	D10
62CA.....	D13	0105.....	D18	169CA.....	D15
62CABH.....	D13	0106.....	D23	169HB-X-MI.....	F26
62CBH.....	D9	0107.....	D24	169HB-X-MIX.....	E12
62P.....	D29, D30	0108.....	D21	169LP.....	D33
62PBH.....	D30	0109.....	D20, D21	169P.....	D33
62PCA.....	D13, D30	0110.....	D25, D27	169PS.....	D33
62PCABH.....	D13, D30	0111.....	D25	170C.....	D11
62PLP.....	A8	0114.....	D20	170CA.....	D15
62PLPBH.....	A8	0116.....	D23	170P.....	D34

171C.....	D11	264C.....	D10	0438.....	H14
171CA.....	D15	264CA.....	D14	0439.....	H15
171HB.....	E12	265C.....	D10	0446.....	H9
171P.....	D34	265CA.....	D14	0448.....	H10
172C.....	D11	269C.....	D10	0449.....	H13
172CA.....	D15	269CA.....	D15	0452.....	H11
172P.....	D34	269HB.....	E13	0461.....	H10
176C.....	D11	270C.....	D11	0462.....	H10
176CA.....	D16	270CA.....	D15	0465.....	H30
177C.....	D11	279HB.....	E13	0469.....	H13
177CA.....	D16	0285.....	I11	0471.....	H9
177P.....	D34	309P.....	B40	0472.....	H9
179C.....	D11	313GH.....	B43	0482.....	H10
179CA.....	D16	316GH.....	B43	0483.....	H11
179HB.....	E12	316P.....	B41	0489.....	H13
179HB-X-MI.....	E13, F26	318P.....	B40	0490.....	H25
0191.....	E14	322HB.....	B40	0491.....	H25
0192.....	F24	325GH.....	B43	0492.....	H25
0199.....	D21	325GHSV.....	B43	0496.....	H26
0200.....	I11	325HB.....	B41	0497.....	H26
0205.....	I11	326HB.....	B41	0499.....	H15
0206.....	I11	328HB.....	B43	0602.....	I9
207ACBH.....	F9	329HB.....	B42	0610.....	I7
207ACBH-S.....	F9	362HB.....	B42	0611.....	I8
207P.....	F9	364HB.....	B40	0614.....	I8
208P.....	F9	365HB.....	B40	0621.....	I6
209P.....	F9	370HB.....	B42	639C.....	D11
210P.....	F10	372HB.....	B42	639CA.....	D16
211P.....	F10	391P.....	D31	0659.....	I6
212P.....	F10	391PSS.....	D31	0660.....	A103
213P.....	F10	392P.....	D31	0661.....	A103
215PN.....	F10	392PSS.....	D31	0669.....	A103
215PNL.....	F10	393P.....	D31	0670.....	I7
216P.....	F11	393PD.....	D32	0671.....	I7
218P.....	F11	393PDSS.....	D32	0672.....	I8
219P.....	F11	393PSS.....	D31	0673.....	I7
0220.....	D27, E7	394P.....	D32	0674.....	I8
220P.....	F11	394PD.....	D32	0676.....	I8
222P.....	F11	394PDSS.....	D32	0677.....	I7
222P-X-MI.....	F26	394PSS.....	D32	0682.....	A71, I8
222P-X-MIX.....	F18	398P.....	D32	682C.....	D11
224.....	E7	398PD.....	D33	682CA.....	D16
225.....	E7	398PDSS.....	D33	0683.....	A71, I8
228.....	E7	398PSS.....	D32	685HB.....	E10
229.....	E7	0400.....	H9	0900.....	F23
230.....	E8	0401.....	H8	0901.....	F24
231.....	E8	0402.....	H8	901GH.....	F29
232.....	E8	0411.....	H12	0902.....	F24
237.....	E8	0414.....	H12	0903.....	F22
238.....	E8	0432.....	H14	0904.....	F23
255M.....	F13	0437.....	H15	0905.....	F23

0906.....	F23	2201P.....	F13	3158.....	A27
0907.....	F23	2202P.....	F12	3159.....	A50
0908.....	F22	2203P.....	F12	3160.....	A49
0909.....	F22	2205P.....	F13	3166.....	A42
0910.....	F21	2214P.....	F13	3168.....	A42
0911.....	F21	2224P.....	F12	3169.....	A21
0912.....	F21	2225P.....	F12	3171/3181.....	A17
0913.....	F21	3000 70.....	A51	3175.....	A16
0914.....	F21	3000 71.....	A51	3180.....	A39
0915.....	F21	3000 71 00.....	J16	3182.....	A39
0916.....	F22	3000 71 11.....	J16	3183.....	A40
0917.....	F22	3008.....	A24	3184.....	A39
0920.....	F23	3009.....	A21	3188.....	A40
0921.....	F21	3014.....	A18	3189.....	A50
0922.....	F21	3018.....	A29	3192.....	A21
0923.....	F22	3036/3136.....	A36	3193.....	A24
0924.....	F22	3091.....	A49	3198.....	A24
0927.....	F22	3100.....	C6	3199.....	A20
0928.....	F22	3101.....	A17	3300.....	A46
0929.....	F19	3102.....	A33	3304.....	A38
0931.....	E14	3103.....	A25	3306.....	A38
1163-60-BPD.....	F29	3104.....	A34	3320.....	A47
1163-61-BPD.....	F29	3106.....	A32	3321.....	A47
1200P.....	F11	3107.....	A38	3329.....	A47
1201P.....	F13	3108.....	A23	3379.....	A45
1202P.....	F12	3109.....	A19	3381.....	A45
1203P.....	F12	3110/3330.....	A52, J16	3391.....	A49
1204P.....	F12	3113.....	A22	3524.....	A31
1295HB.....	E11	3114.....	A18	3527.....	A31
1695HB.....	E12	3116.....	A37	3528.....	A31
1725HB.....	E12	3118.....	A29	3529.....	A31
1795HB.....	E12	3119.....	A32	3538.....	A30
1817.....	F14	3120.....	A41	3539.....	A30
1821.....	F16	3121.....	A26	3549.....	A30
1823.....	F16	3122.....	A43	3800 70.....	A71
1827.....	I10	3124.....	A31	3801.....	A66
1843.....	F14	3126.....	A43	3802.....	A70
1844.....	F14	3129.....	A20	3804.....	A70
1845.....	F14	3131.....	A26	3805.....	A66
1855.....	F14	3132.....	A27	3806.....	A70
1861.....	F16	3133/3113.....	A22	3809.....	A68
1862.....	F15	3139.....	A36	3816.....	A71
1863.....	F15	3140.....	A35	3821.....	A69
1864.....	F15	3142.....	A41	3826.....	A71
1867.....	F15	3143.....	A41	3831.....	A69
1870.....	F15	3144.....	A35	3866.....	A71
1871.....	F14	3146.....	A36	3879.....	A67
1872.....	F15	3148.....	A27	3889.....	A67
1873.....	F16	3149/3049.....	A32	3893.....	A68
2200P.....	F11	3151.....	A51	3899.....	A68
2200PDE.....	F13	3156.....	A37	4202.....	H44

4203.....	H44	7105.....	A93	9405U.....	G7, G8, G12
4298.....	H45	7110/7111	A93	9410A.....	G9, G16
4299.....	H45	7115.....	A93	9410U.....	G7, G12
4602.....	H26	7160.....	A93	9415A.....	G9, G15
4810.....	H30	7300.....	A113	9415U.....	G7, G8, G12, G13
4832.....	H30	7305.....	A113	9417A.....	G16
4890.....	A99	7620.....	A84	9417U.....	G7, G8, G12, G13
4891.....	A99	7625.....	A84	9421A.....	G9, G16
4892.....	A99	7630/7631	A88	9421U.....	G7, G8, G12, G13
4895.....	A99	7640/7645	A86	9442A.....	G9, G16
4902.....	H8	7640/7649	A86	9442U.....	G7, G8, G13
6300.....	C8	7660/7669	A83	9803.....	G15
6302.....	B11	7660/7669/7662	A84	9804.....	G14
6304.....	B10	7665/7668	A83	ADJ-CB.....	, I13
6306.....	B10	7770.....	A90	AQRT.....	, A51, A51, B30, B30
6307.....	B13	7771.....	A91	BU.....	B22, B34
6315.....	B7	7772.....	A90	BVC.....	B16, B44, H41
6316.....	B7	7775.....	A91	C9000.....	G13
6322.....	B13	7776.....	A90	CAP.....	B24
6325.....	B8	7800/7801	A115	CU.....	B24
6326.....	B13	7805/7806	A115	EU.....	B19, B33
6340.....	B11	7808.....	A108	F3HG.....	F18
6351.....	B12	7810/7812	A95	FA.....	B20
6366.....	B11	7810/7815/7812/7817	A95	FC.....	B22, B34
6380.....	B13	7818.....	A108	FE.....	B25, B34
6382.....	B12	7828.....	A109	FF.....	B24
6383.....	B12, B13	7828/7829	A109	GR.....	B35
6388.....	B12	7835.....	A95	LF3600	C11
6401.....	H11	7880.....	A106	LF3800	C11
6402.....	H11	7881.....	A106	LSR-Stand.....	I14
6503.....	B9, B10	7885.....	A106	MC.....	B19, B33
6505.....	B7	7886.....	A106	MCVC.....	B27
6508.....	B9	7892.....	A101	ME.....	B23, B33
6509.....	B8, B9	7894.....	A101	MES.....	B20
6521.....	B8	7910.....	A111, H28	MR.....	B34
6548.....	B13	7911.....	A111, H28	MRS.....	B20
6579.....	B8	7913.....	A111, H28	MT.....	B34
7000.....	A51, A90	7914.....	A111, H28	MTS.....	B21
7010/7011	A81	7915.....	A111, H28	MV200	H24
7012.....	A81	7970.....	A104	MV608	H24
7015/7016	A81	7982.....	A104	MV609	H24
7030/7031	A88	7994/7984	A97	MV708	H22
7040/7041	A86	7994/7995/7984/7985	A97	MV709	H22
7045.....	A86	7995/7985	A97	NS.....	B35
7060.....	A79	7996.....	A97	NV311P	D34
7061.....	A80	9080A.....	G9, G15	NV312P	D34
7062.....	A79	9080U.....	G7, G8, G12, G13	OR.....	B35
7065.....	A78	9083.....	G7, G8, G9, G11, G14	RD.....	B23
7066.....	A79	9084.....	G7, G8, G9, G11, G14	SAE 060101 BA.....	D8
7067.....	A79	9085.....	G7, G8, G9, G11, G14, G15	SAE 060102 BA.....	D9
7100/7101	A93	9405A.....	G9, G15	SAE 060103 BA.....	D9

SAE 060110.....	D8	W169PLP.....	A10
SAE 060111.....	D8	W169PLPNS.....	A10
SAE 060115.....	D8	W171PLP.....	A10
SAE 060201 BA.....	D10	W172PLP.....	A11
SAE 060202 BA.....	D10	WY.....	B21
SAE 060203 BA.....	D11		
SAE 060401 BA.....	D10		
SAE 060424 BA.....	D11		
SAE 060425 BA.....	D11		
SC.....	B30, B30		
ST.....	B24		
TAF.....	B24		
TCB.....	B24		
TEB.....	B25		
TEU.....	B23		
TFA.....	B24		
TMC.....	B22		
TPL.....	B25		
TS.....	B30, B35, B30, B35		
TSC.....	B26, C10		
TU.....	B19, B34		
UC.....	B21, B33		
V500P.....	H17		
V500P-20.....	H17		
V500P-24.....	H17		
V500P-32.....	H17		
V500P-X-04.....	H18		
V500P-X-21.....	H18		
V501SS.....	H31		
V502SS.....	H33		
V502SS-X-20.....	H33		
V502SS-X-21.....	H33		
V520P.....	H20		
V525P.....	H21		
VAS.....	B16		
VC.....	A97, B27		
VEU.....	B29, B30, B15, B15, B15, B37		
VFC.....	B29, B43, B44, B15, B15, B36		
VFE.....	B15, B28, B15, B37, B44, B44		
VMC.....	B29, B27, B15, B36, B44, B44		
VME.....	B14, B28, B37, B44		
VP500P.....	H17		
VP502SS.....	H33		
VP520P.....	H20		
VTEU.....	B30		
VUC.....	B29, B14, B30, B14, B14, B36, B14, B44, B44		
VUCPB.....	B16, B44		
VV500P.....	H17		
VVP500P.....	H17		
W68PLP.....	A8		

Parker's Motion & Control Product Groups

At Parker, we're guided by a relentless drive to help our customers become more productive and achieve higher levels of profitability by engineering the best systems for their requirements. It means looking at customer applications from many angles to find new ways to create value. Whatever the motion and control technology need, Parker has the experience, breadth of product and global reach to consistently deliver. No company knows more about motion and control technology than Parker. For further info call 1 800 C-Parker (1 800 272 7537).



Aerospace

Key Markets

Aftermarket services
Commercial transports
Engines
General & business aviation
Helicopters
Launch vehicles
Military aircraft
Missiles
Power generation
Regional transports
Unmanned aerial vehicles

Key Products

Control systems & actuation products
Engine systems & components
Fluid conveyance systems & components
Fluid metering, delivery & atomization devices
Fuel systems & components
Fuel tank inerting systems
Hydraulic systems & components
Thermal management
Wheels & brakes



Automation

Key Markets

Alternative energy
Conveyor & material handling
Factory automation
Food & beverage
Life sciences & medical
Machine tools
Packaging machinery
Paper machinery
Plastics machinery
Primary metals
Safety & security
Semiconductor & electronics
Transportation & automotive

Key Products

AC/DC drives & systems
Air preparation
Electric actuators, gantry robots & slides
Human machine interfaces
Inverters
Manifolds
Miniature fluidics
Pneumatic actuators & grippers
Pneumatic valves & controls
Rotary actuators
Stepper motors, servo motors, drives & controls
Structural extrusions
Vacuum generators, cups & sensors



Climate & Industrial Controls

Key Markets

Agriculture
Air conditioning
Construction Machinery
Food & beverage
Industrial machinery
Life sciences
Oil & gas
Precision cooling
Process
Refrigeration
Transportation

Key Products

Accumulators
Advanced actuators
CO₂ controls
Electronic controllers
Filter driers
Hand shut-off valves
Heat exchangers
Hose & fittings
Pressure regulating valves
Refrigerant distributors
Safety relief valves
Smart pumps
Solenoid valves
Thermostatic expansion valves



Filtration

Key Markets

Aerospace
Food & beverage
Industrial plant & equipment
Life sciences
Marine
Mobile equipment
Oil & gas
Power generation & renewable energy
Process
Transportation
Water Purification

Key Products

Analytical gas generators
Compressed air filters & dryers
Engine air, coolant, fuel & oil filtration systems
Fluid condition monitoring systems
Hydraulic & lubrication filters
Hydrogen, nitrogen & zero air generators
Instrumentation filters
Membrane & fiber filters
Microfiltration
Sterile air filtration
Water desalination & purification filters & systems



Fluid Connectors

Key Markets

Aerial lift
Agriculture
Bulk chemical handling
Construction machinery
Food & beverage
Fuel & gas delivery
Industrial machinery
Life sciences
Marine
Mining
Mobile
Oil & gas
Renewable energy
Transportation

Key Products

Check valves
Connectors for low pressure fluid conveyance
Deep sea umbilicals
Diagnostic equipment
Hose couplings
Industrial hose
Mooring systems & power cables
PTFE hose & tubing
Quick couplings
Rubber & thermoplastic hose
Tube fittings & adapters
Tubing & plastic fittings



Hydraulics

Key Markets

Aerial lift
Agriculture
Alternative energy
Construction machinery
Forestry
Industrial machinery
Machine tools
Marine
Material handling
Mining
Oil & gas
Power generation
Refuse vehicles
Renewable energy
Truck hydraulics
Turf equipment

Key Products

Accumulators
Cartridge valves
Electrohydraulic actuators
Human machine interfaces
Hybrid drives
Hydraulic cylinders
Hydraulic motors & pumps
Hydraulic systems
Hydraulic valves & controls
Hydrostatic steering
Integrated hydraulic circuits
Power take-offs
Power units
Rotary actuators
Sensors



Instrumentation

Key Markets

Alternative fuels
Biopharmaceuticals
Chemical & refining
Food & beverage
Marine & shipbuilding
Medical & dental
Microelectronics
Nuclear Power
Offshore oil exploration
Oil & gas
Pharmaceuticals
Power generation
Pulp & paper
Steel
Water/wastewater

Key Products

Analytical Instruments
Analytical sample conditioning products & systems
Chemical injection fittings & valves
Fluoropolymer chemical delivery fittings, valves & pumps
High purity gas delivery fittings, valves, regulators & digital flow controllers
Industrial mass flow meters/ controllers
Permanent no-weld tube fittings
Precision industrial regulators & flow controllers
Process control double block & bleeds
Process control fittings, valves, regulators & manifold valves



Seal

Key Markets

Aerospace
Chemical processing
Consumer
Fluid power
General industrial
Information technology
Life sciences
Microelectronics
Military
Oil & gas
Power generation
Renewable energy
Telecommunications
Transportation

Key Products

Dynamic seals
Elastomeric o-rings
Electro-medical instrument design & assembly
EMI shielding
Extruded & precision-cut, fabricated elastomeric seals
High temperature metal seals
Homogeneous & inserted elastomeric shapes
Medical device fabrication & assembly
Metal & plastic retained composite seals
Shielded optical windows
Silicone tubing & extrusions
Thermal management
Vibration dampening

Parker Fluid Connectors Group

North American Divisions & Distribution Service Centers

Your complete source for quality tube fittings, hose & hose fittings, brass & composite fittings, quick-disconnect couplings, valves, and assembly tools, locally available from a worldwide network of authorized distributors.

Fittings:

Available in inch and metric sizes covering SAE, BSP, DIN, GAZ, JIS, and ISO thread configurations, manufactured from steel, stainless steel, brass, aluminum, nylon, and thermoplastic.

Hose, Tubing, and Bundles:

Available in a wide variety of sizes and materials including rubber, wire-reinforced, thermoplastic, hybrid and custom compounds.

Worldwide Availability:

Parker operates Fluid Connectors manufacturing locations and sales offices throughout North America, South America, Europe, and Asia-Pacific.

For information, call toll-free:
1-800-C-PARKER
(1-800-272-7537)

North American Divisions

Fluid System Connectors Division

Otsego, MI
phone 269 692 6555
fax 269 694 4614

Engineering Support:

FSC.Apps@support.parker.com

Customer Support:

FSC.Support@support.parker.com

Quote Support:

FSC.Quotes@support.parker.com

Hose Products Division

Wickliffe, OH
phone 440 943 5700
fax 440 943 3129

Parflex Division

Ravenna, OH
phone 330 296 2871
fax 330 296 8433

Quick Coupling Division

Minneapolis, MN
phone 763 544 7781
fax 763 544 3418

Tube Fittings Division

Columbus, OH
phone 614 279 7070
fax 614 279 7685

Distribution Service Centers

Buena Park, CA

phone 714 522 8840
fax 714 994 1183

Conyers, GA

phone 770 929 0330
fax 770 929 0230

Louisville, KY

phone 502 937 1322
fax 502 937 4180

Portland, OR

phone 503 283 1020
fax 503 283 2201

Toledo, OH

phone 419 878 7000
fax 419 878 7001
fax 419 878 7420
(FCG Kit Operations)

Canada

Milton, ONT

phone 905 693 3000
fax 905 876 1958

Mexico

Toluca, MEX

phone (52) 722 2754 200
fax (52) 722 2722 168

Parker Hannifin Corporation
Fluid System Connectors Division
300 Parker Drive
Otsego, MI 49078
Phone: 269 692 6555
Fax: 269 694 4614